

State-Sum Invariants of 4-Manifolds, I

Louis Crane

*Department of Mathematics
Kansas State University
Manhattan, KS 66506*

Louis H. Kauffman

*Department of Mathematics, Statistics
and Computer Science*

*University of Illinois at Chicago
851 S. Morgan Street
Chicago, IL 60607-7045*

David N. Yetter

*Department of Mathematics
Kansas State University
Manhattan, KS 66506*

Abstract: We provide, with proofs, a complete description of the authors' construction of state-sum invariants announced in [CY], and its generalization to an arbitrary (artinian) semisimple tortile category. We also discuss the relationship of these invariants to generalizations of Broda's surgery invariants [Br1,Br2] using techniques developed in the case of the semi-simple sub-quotient of $Rep(U_q(sl_2))$ (q a principal $4r^{th}$ root of unity) by Roberts [Ro1]. We briefly discuss the generalizations to invariants of 4-manifolds equipped with 2-dimensional (co)homology classes introduced by Yetter [Y6] and Roberts [Ro2], which are the subject of the sequel.

1 Introduction

Ever since the seminal papers [A] and [W], mathematicians and physicists have been interested in the problem of construction of topological quantum field theories. From the beginning of the subject, the indication has been that the most important example would be in dimension four, namely, Donaldson-Floer theory. The belief, which has never been rigorously substantiated in general, is that 4D-TQFTs can be constructed, which would generalize the line of development initiated by Donaldson [D] (cf. also [DK]), which has led to the recent advances in our knowledge of the smooth structures on 4 manifolds.

If we examine the current progress of the efforts at construction of TQFTs, we see that there is a very deep gap between the situation in dimensions 2 and 3, and that in dimension 4. The picture in $D=2,3$ is that the TQFTs can be directly constructed in various ways by connecting structures from abstract algebra (including categorical algebra) to various decompositions of manifolds. For example, in $D=2$, we can construct TQFTs either by connecting a handlebody decomposition to a commutative Frobenius algebra, or by connecting a triangulation to a semisimple algebra [CFS]. In $D=3$, we can either produce a theory by relating a Heegaard splitting (or more generally, a handlebody decomposition) or a triangulation to a Hopf algebra or modular tensor category [TV,Cr1,Ku]. More recently, it has also been shown how to get a 3D theory by connecting a surgery presentation to a Hopf algebra [RT]. (cf. also [KaLi])

In contrast, the picture in $D=4$ is much less clear. Aside from trivial examples involving finite groups, the 4D theories under active study have not been constructed in general. Special cases are computed, either by extremely difficult methods involving analysis on moduli spaces of instantons [D,DK], or, on a nonrigorous level, by means of techniques from quantum field theory [W1].

The purpose of this paper is to begin to bridge the gap between the 3D and 4D situations. In [CY], the authors produced a new 4D-TQFT by using methods analogous to the lower dimensional constructions. More specifically, we showed how to produce a 4D-TQFT from the category of representations of the quantum group $SU(2)_q$ with q a root of unity. The present paper provides formal proofs and a general setting for the construction. We prove the theorem that the analog of the construction in [CY] for an artinian semisimple tortile category gives rise to a 4D-TQFT. We also present an approach to proving that a state sum is topological, the blob property, which may have applications in other settings.

In our original case, it has been demonstrated in [CKY1] and [Ro1], that the invariant which we obtain for a closed 4 manifold is a combination of the Euler character and the signature. In particular, our formula gives a new solution to the classical problem, first solved by Gelfand, of finding a combinatorial formula for the signature of a 4 manifold.

There remains the question of how closely our theory is related to Donaldson-Floer theory. One might naively think, that since the invariants we attach to closed manifolds are topological, i.e., not dependent on smooth structure, that there would be no hope of any significant relationship.

The actual situation is somewhat more complex, and turns on the issue of insertions. It is quite a general phenomenon that constructions of TQFTs can be extended to give invariants of manifolds with labelled imbedded submanifolds. For example, the CSW 3D-TQFT can be easily extended to give invariants of framed labelled graphs, which are, in fact, generalizations of the Jones polynomial [W2, Cr1, Wa RT].

If we could construct DF theory as a TQFT, its topological significance would depend, in an essential manner, on two types of insertions, one on surfaces, and one on points. The insertion on points corresponds to a twist in the bundle, ie to changing the second Chern class of the bundle in which the DF theory takes place. The insertion on surfaces is represented in the picture of DF theory from moduli spaces, by restricting to submanifolds of moduli space corresponding to connections which have nonvanishing index when restricted to the surfaces. In [W3], Witten formally reproduces DF theory, in the special case of Kahler manifolds, as a TQFT with just such insertions, although in a

nonrigorous approach.

It is then natural to ask if we can find topologically invariant ways of modifying our state sum to include insertions, and if so, whether they produce results related to DF theory.

Our investigation of this question is so far incomplete, but the results are interesting. In [Y2] and [Ro2], two closely related procedures have been found for modifying our formula to include insertions on surfaces. These prescriptions are invariant under homotopy of the surfaces. In [Ro2], it was demonstrated that the invariant of a manifold with embedded surfaces counts the intersection numbers of the surfaces.

This is an intriguing result, since there has recently appeared some new information about DF theory, deduced rigorously in [KM] and nonrigorously (but very beautifully) in [W3]. The formula these sources derive shows that the generating function for the DF invariants can be expressed as an exponential involving the Euler character and signature, times a quadratic exponential involving the intersection form, times a sum of “subdominant” exponentials which are sensitive to the smooth structure of the manifold. It is not possible to see the effect of the subdominant exponentials without looking at terms corresponding to twisted bundles.

It follows that the question of how much information our theory can detect is closely connected to the question of whether we can find a natural way to modify it to include twists in the bundle, and what effect they have on the sum. We have not solved this problem as of this writing, but we see several natural approaches. Unfortunately, the dimension of the vector space which our TQFT assigns to S^3 is 1, so it is hard to see how an “instanton” could contribute anything more than a multiplier. Thus, it is still not completely clear whether a natural modification of our expression will make it sensitive to smooth structure, but it is most probable that we have reconstructed the fictitious cousin of DF theory discussed in [W3].

Our formula is not the only possible approach to a 4D state sum. In [CF], another approach is outlined, making use of a more subtle piece of algebraic structure, a Hopf category. There is reason to hope that the entire picture in 4D can be rendered as algebraic as the lower dimensional cases.

Physical Applications

Let us also mention the possibility that 4D topological state sums may play a role in the problem of quantizing gravity. The first piece of evidence we can cite is the work of Regge and Ponzano [RP] on spin networks. They reinterpreted Penrose’s spin network [P] approach to quantum gravity by using the techniques of the graphical calculus to rewrite the evaluation of a spin network as a sort of discretized path integral. The form of their expression is identical to the TQFT of Turaev and Viro [TV], except that they use a Lie group instead of a quantum group. Their state sum gives an interesting approach to quantum theory for 3D gravity. It is then natural to wonder if a 4D state sum model could play a similar role. This leads into great complexities of interpretation, but see [Cr2] for a possible approach.

A topological state sum has many attractive features as a tool to describe a quantum theory of gravity. It occupies a position intermediate between a path integral for a continuum theory and a lattice approximation to the theory, as a sort of magic lattice theory which is invariant under any change of the lattice. This resonates nicely with the old idea that it is not possible to measure the distance between two physical points and get a value less than the Planck scale.

In summation, topological 4D state sums are a very new construction, whose possibilities have not been explored fully, which may have many applications.

Throughout, all manifolds are assumed to be piecewise-linear (equivalently smooth) oriented, and unless stated to the contrary to have empty boundary.

2 Tortile Categories

This section has two subsections. In the first, we review the properties of two versions of the recoupling theory associated with the quantum group $U_q(sl_2)$. These recoupling theories and their properties can be used directly to build the simplest cases of the 4-manifold invariants discussed in this paper. This is the example which has been most fully understood. The reader who is interested primarily in this case of the construction can read the first subsection, then proceed directly to Section 3.

The second subsection describes the general setting for our construction in terms of semi-simple tortile categories. This general setting for the invariants is of great potential value since it gives a framework in which future applications to quantum groups or other categories can be cradled.

2.1 $U_q(sl_2)$ Recoupling Theory

In this section we give a quick resumé of two versions of $U_q(sl_2)$ recoupling theory and the relationships between them. Both formulations are useful in studying our 4-manifold invariants, and in the following sections we shall express the invariants in terms of both.

We begin with a review of the knot-theoretic and combinatorial Temperley-Lieb recoupling theory. The principal reference for this version is [KaLi]. We shall refer to this as the *TL theory*.

The TL theory is based on the bracket polynomial model for the original Jones polynomial [J]. Recall that the bracket polynomial $\langle K \rangle$ is a Laurent polynomial in A satisfying the relations in Figure 1

$$\begin{aligned}
 \langle \text{crossing} \rangle &= A \langle \text{cup and cap} \rangle + A^{-1} \langle \text{cap and cup} \rangle \\
 \langle \text{circle } K \rangle &= (-A^2 - A^{-2}) \langle \text{strand } K \rangle
 \end{aligned}$$

Figure 1: Axioms for the Bracket Polynomial

In the first equation, the small diagrams stand for larger link diagrams differing only at the site shown. In the second, the circle stands for an extra component disjoint from the rest of the diagram. We let $d = -A^2 - A^{-2}$.

The bracket evaluation is an invariant of regular isotopy—the equivalence relation generated by the Reidemeister moves II and III, shown in Figure 2.

Under the first Reidemeister move, we have the equations of Figure 3 from which it is readily seen that the bracket is, moreover, invariant under framed isotopy—the equivalence generated by Reidemeister Moves II and III, and the “framed first Reidemeister move” of Figure 4—an observation which is important to the applications of the bracket to surgery descriptions of manifolds, and to the categorical formulation of the second subsection.

The recoupling formulation based on the bracket polynomial involves applying the bracket polynomial to links with parallel cables. Parallel cabling is indicated by labelling a link component with

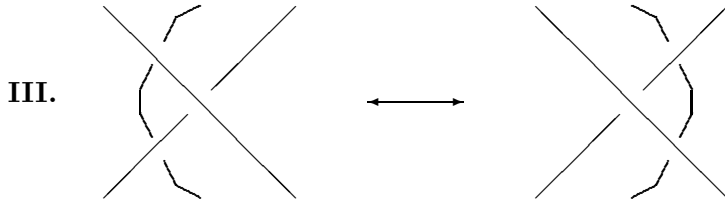
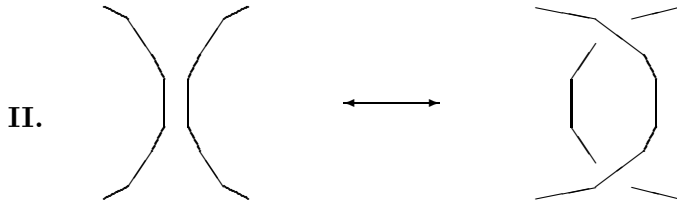


Figure 2: Regular Isotopy—Reidemeister Moves II and III

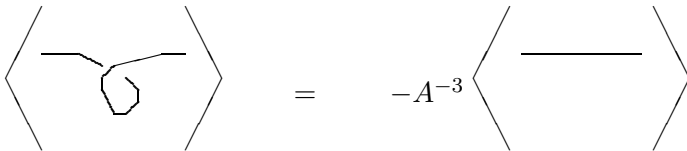
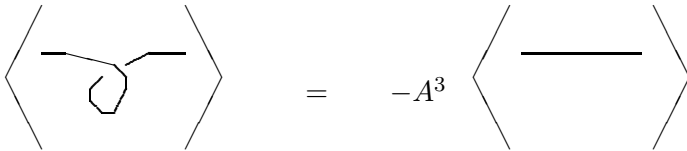


Figure 3: The Bracket under Reidemeister I

an integer $a \geq 0$. That component is then replaced by a parallel components.¹ An example is given in Figure 5

We then define q -symmetrizers (here $A = \sqrt{q}$) by the formula of Figure 6 in which $\{a\}! = \sum_{\sigma \in \mathcal{S}_n} (A^{-4})^{t(\sigma)}$, \mathcal{S}_n is the permutation group on n letters, $\hat{\sigma}$ is the usual lift of σ to positive braids, and $t(\sigma)$ is the least number of transpositions needed to express σ .

One then has that the q -symmetrizers are projectors in the sense given in Figure 7 in which i ranges between 1 and $a - 1$, and U_i is the standard generator for the Temperley-Lieb algebra shown in Figure 8.

Equations of the sort in Figure 7 mean identities for bracket evaluations of closed diagrams. Hereafter, we omit the brackets when writing labelled link diagrams in algebraic contexts. Thus, for example, we use the expression in Figure 9 instead of that in Figure 10

Other useful formulae about the symmetrizers are given in Figure 11.

¹The reader must remember that we are dealing with *diagrams*, if one insists on thinking of the link in 3-dimensional space, we are using the “blackboard framing”.

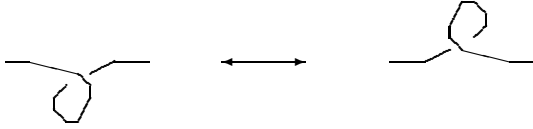


Figure 4: The Framed First Reidemeister Move

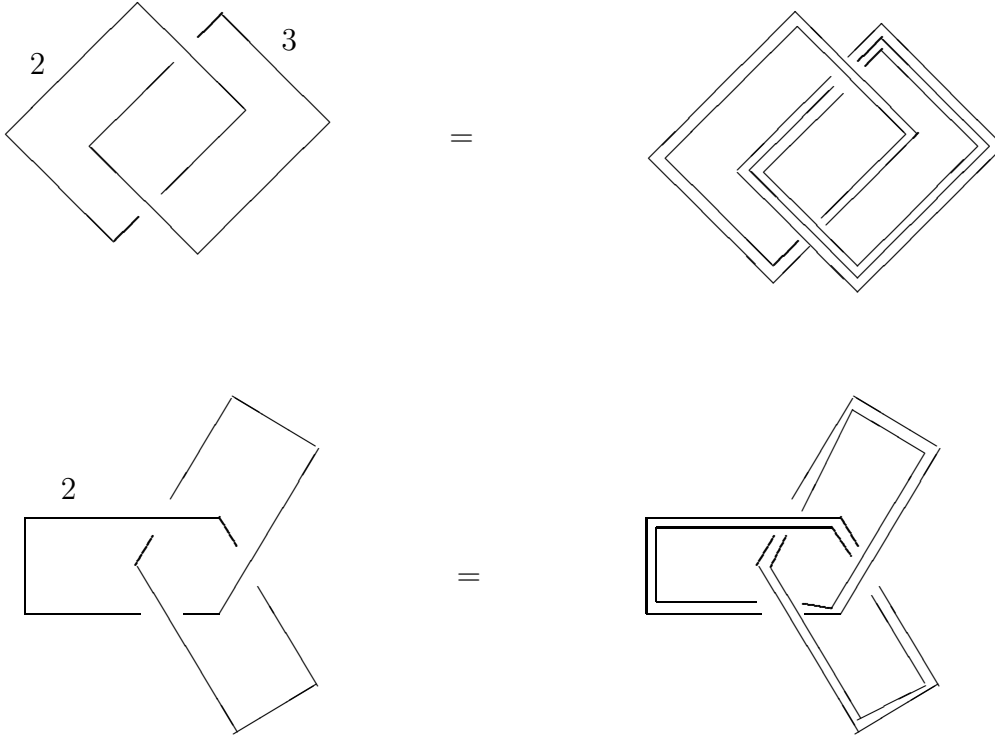


Figure 5: Examples of cabling

The q -symmetrizers are used to build 3 -vertices and these are the core of the recoupling theory. They are defined in Figure 12 in which $i + j = a$, $i + k = b$, $j + k = c$.

The (a, b, c) vertex exists exactly when $a + b + c$ is even and the sum of any two elements of the set a, b, c is greater than or equal to the third. (We will occasionally write vertices where these conditions fail, the evaluation of any diagram with such a non-existent vertex is 0.)

One can check that crossings and 3-vertices are related as in Figure 13 in which $x' = x(x + 2)$.

Other properties, such as that shown in Figure 14 follow directly from the genesis of the 3-vertex in terms of bracket evaluation.

Two important network evaluations have explicit formulas that we omit here (see Kauffman and Lins [KaLi]). These are the *theta net*, $\theta(a, b, c)$, shown in Figure 15 and the *tetrahedral net*,

$$Tet \begin{bmatrix} a & b & e \\ c & d & f \end{bmatrix},$$

shown in Figure 16.

A typical instance of Schur's lemma (see the second subsection) in the TL theory is the formula of Figure 17 in which $\delta_{a,d}$ is the Kronecker delta.

Recoupling of 3-vertices is given in terms of q -6j symbols, which we write with a subscript TL to indicate the Temperley-Lieb algebra formulation as in Figure 18.

These q -6j symbols have an explicit expression in terms of net-evaluations given by

$$\begin{array}{c} | \\ \text{a} \\ \hline | \end{array} = \frac{1}{\{a\}!} \sum_{\sigma \in \mathcal{S}_n} (A^{-3})^{t(\sigma)} \begin{array}{c} | \\ \hat{\sigma} \\ \hline | \end{array}$$

Figure 6: q-symmetrizers

$$\left\{ \begin{array}{ccc} a & b & i \\ c & d & j \end{array} \right\} = \frac{\text{Tet} \left[\begin{array}{ccc} a & b & i \\ c & d & j \end{array} \right] \Delta_i}{\theta(a, d, i)\theta(b, c, i)}.$$

The q -6j symbols satisfy orthogonality and Biedenharn-Elliot identities. They can be used to construct 3-manifold invariants, and, as we shall see, 4-manifold invariants.

The TL theory is rooted in the combinatorics of link diagrams, and it is a direct generalization (q -deformation) of Penrose spin networks (cf. Penrose [P]). Its advantage to us here is that there is no dependence in the diagrammatics of the TL theory on maxima or minima or on the orientation of diagrams with respect to a direction in the plane. Thus TL networks can be freely embedded in manifolds, a feature that we shall use in later sections.

The Kirillov-Reshetikhin formulation of $U_q(sl_2)$ recoupling theory (cf. Kirillov and Reshetikhin [KR]) is based directly on the representation theory of the quantum group $U_q(sl_2)$. Although it lacks the geometric naturalness of the TL theory observed in the last paragraph, the KR theory has good categorical properties: the vertices (in two flavors—two-in-one-out and one-in-two-out—reading from top to bottom) are projections and inclusions from a tensor product of irreducible representations to its irreducible direct summands. It is the KR theory which is generalized to arbitrary semisimple tortile categories in the next subsection.

The basic information needed to transform KR nets into TL nets is the relationship between their 3-vertices shown in Figure 19, in which $\theta(a, b, c)$ is the TL evaluation of a theta-net and we indicate the theory by a label on the vertex.

Note that the KR vertex now has a distinguished direction (since the label on the downward leg is distinguished from the others), while the TL vertex does not have any distinguished direction dependent on leg placement. The value of a closed loop Δ_i is the same in both formulations. ²

²The reader should note that KR nets are often labelled with half-integral “spins”. In that convention, the legs of the KR vertex would be labelled by $\frac{a}{2}$, $\frac{b}{2}$, $\frac{c}{2}$. To avoid complicating notation, we shall label both KR nets and TL nets with integers (twice spin, number of cables, or (non-quantum) dimension–1).

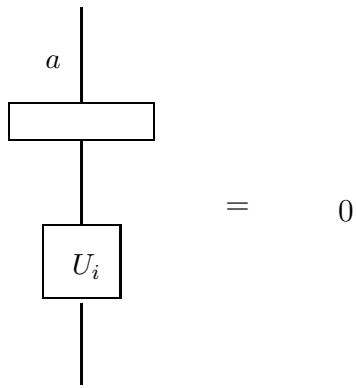
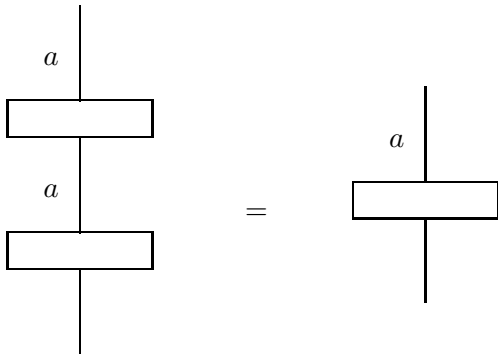


Figure 7:

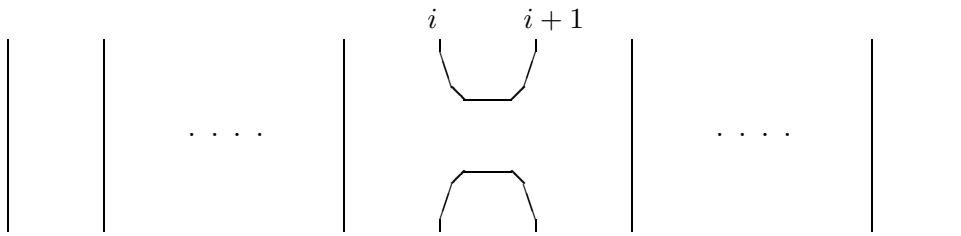


Figure 8: The i^{th} Temperley-Lieb Generator

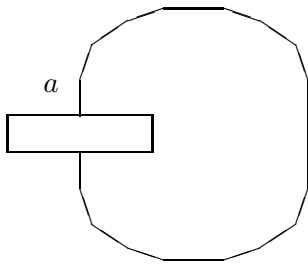


Figure 9: Brackets Hidden

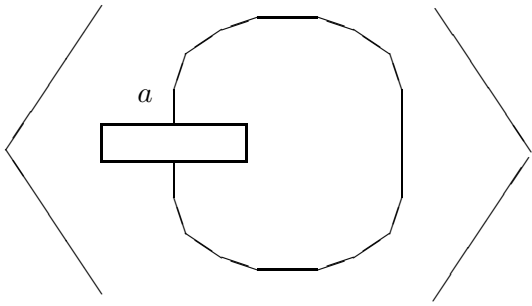
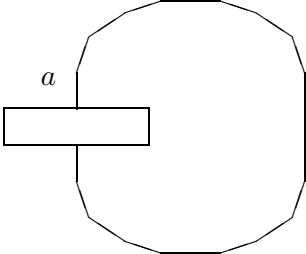
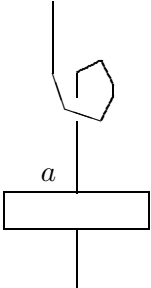
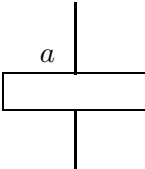


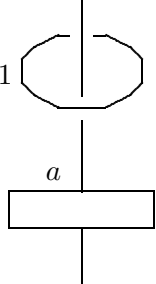
Figure 10: Brackets Shown



$$= \Delta_a = (-1)^a \frac{A^{2a+2} - A^{-2a-2}}{A^2 - A^{-2}}$$



$$= (-1)^a A^{-a(a+2)}$$




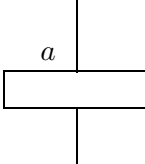
$$= (-A^{2a+2} - A^{-2a-2})$$


Figure 11: Useful Formulae

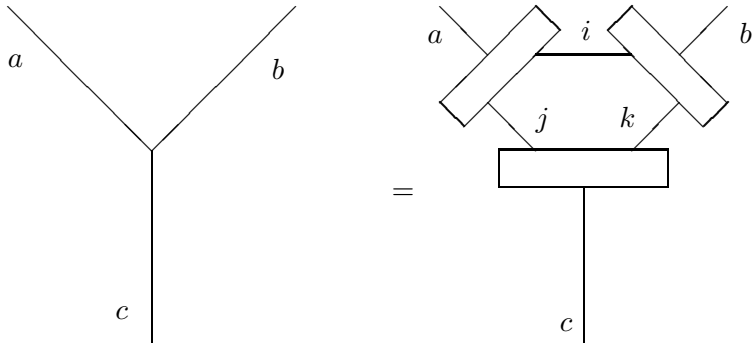


Figure 12: Definition of 3-vertices

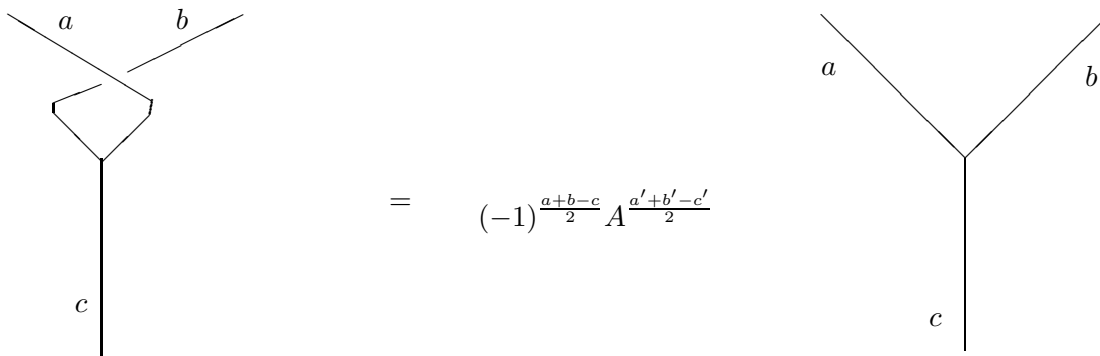


Figure 13: Braiding at a 3-vertex

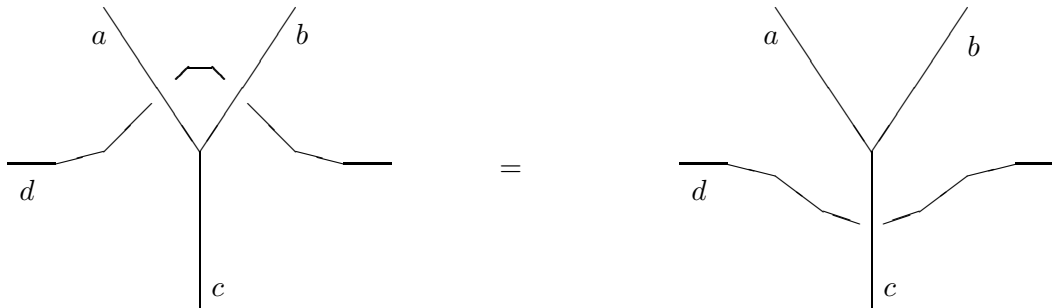


Figure 14: Braiding past a 3-vertex

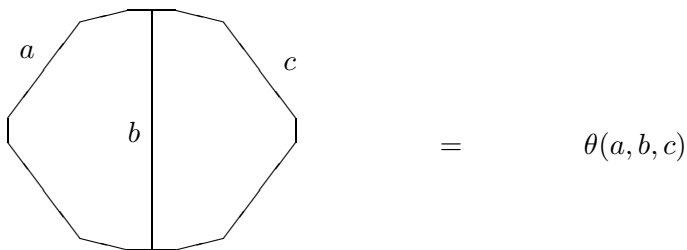


Figure 15: The Theta Net $\theta(a, b, c)$

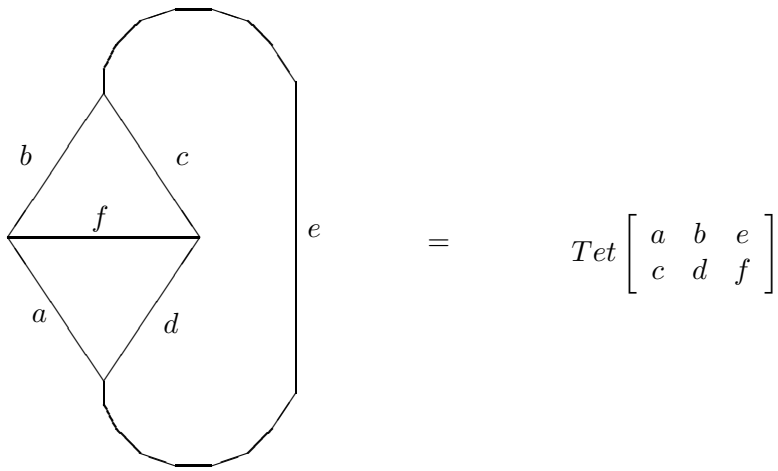


Figure 16: The Tetrahedral Net

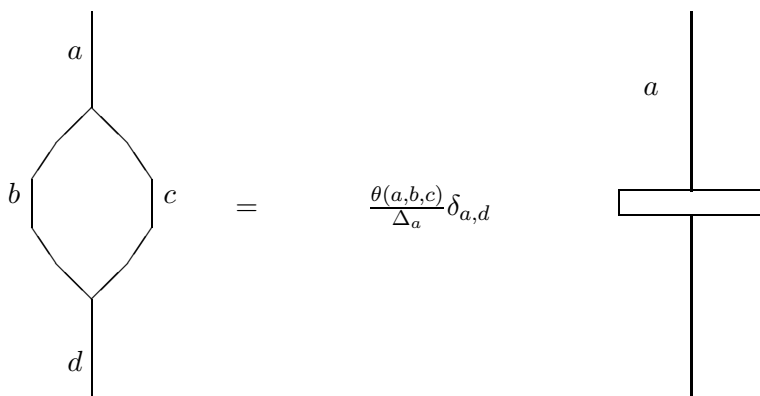


Figure 17: Schur's lemma in TL theory

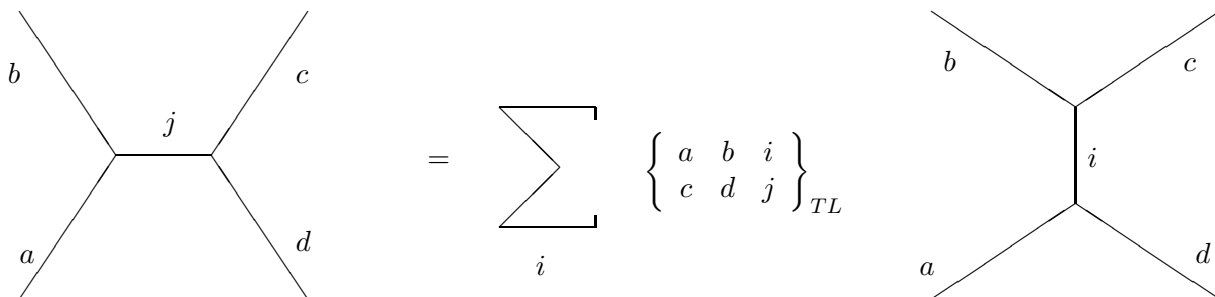


Figure 18: Recoupling via q-6j symbols

$$\begin{array}{c}
 \begin{array}{l}
 a \\
 \diagdown \\
 \text{---} \\
 \diagup \\
 b \\
 \text{---} \\
 \text{---} \\
 c
 \end{array}
 \quad \mathbf{KR}
 \quad = \quad
 \frac{\sqrt{\Delta_c}}{\sqrt{\theta(a,b,c)}}
 \quad
 \begin{array}{c}
 \begin{array}{l}
 a \\
 \diagdown \\
 \text{---} \\
 \diagup \\
 b \\
 \text{---} \\
 \text{---} \\
 c
 \end{array}
 \quad \mathbf{TL}
 \end{array}
 \end{array}$$

Figure 19: KR 3-vertices in terms of TL 3-vertices

The formula relating the KR vertex and the TL vertex lets us derive the identities of KR theory involving cups and caps directly. In the next subsection, we will see that similar identities are a general phenomenon for projection and inclusion maps for direct summands of tensor products in semi-simple tortile categories.

For example, we have

Proposition 2.1 ?

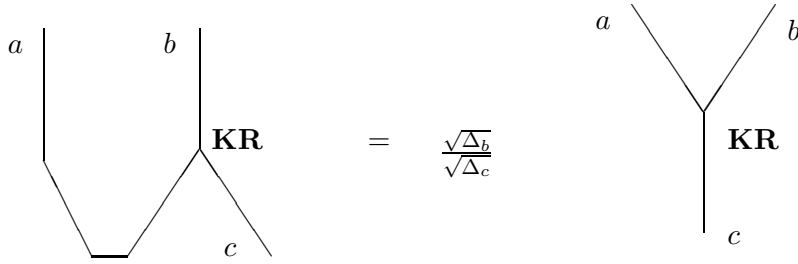


Figure 20: Rotational properties of KR vertices as derived from TL theory

Proof: Given in Figure 21.

In this comparison, the cups and caps of KR theory are the same as those of TL theory, and thus an a labelled cup (resp. cap) is the same as a TL $(a, a, 0)$ 3-vertex in the appropriate orientation or $\sqrt{\Delta_a}$ times a KR 3-vertex with two upward legs labelled a , and a downward one labelled 0 (resp. times a KR 3-vertex with two downward legs labelled a and an upward one labelled 0).

In the next subsection, we develop the general form of the categorical data needed for our constructions. KR and TL recoupling networks provide two formulations of the most fundamental example: the representation theory of $U_q(\mathfrak{sl}_2)$.

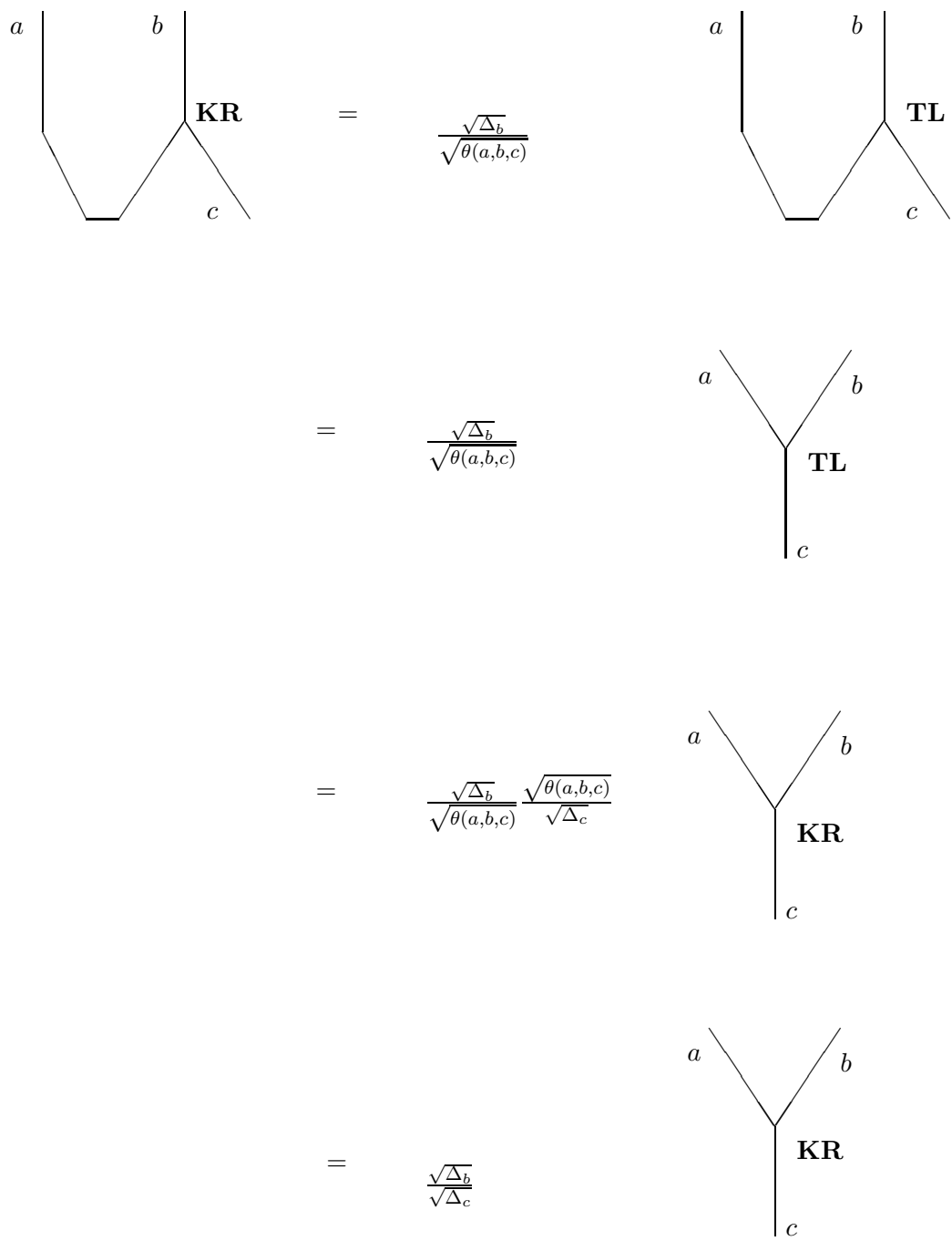


Figure 21: Proof of Proposition 2.1

2.2 General semi-simple tortile categories

The initial data required for our construction is the same as that required for the constructions of Yetter [Y3]: a semisimple tortile category over a field K . Non-degeneracy conditions as in Turaev [T] will be required only for the surgical versions given in Section 4. We review the necessary axiomatics and categorical results.

The axioms fall into two types: those dealing with the linearity structure over a field K , and those dealing with the monoidal and duality structure of the category. We begin with the latter. We assume familiarity with the basic notions of monoidal category theory and abelian category theory (cf. Mac Lane [CWM]) and with basic notions associated with categories of tangles (cf. Freyd/Yetter [FY1,FY2], Joyal/Street[JS1,JS2], Resetikhin/Turaev [RT], Shum [S], Yetter [Y1]).

Our categories will all be K -linear abelian monoidal categories with \otimes exact in both variables, but will be equipped with additional structure. One piece of structure we will require is the presence of dual objects:

Definition 2.2 *A right (resp. left) dual to an object X in a monoidal category \mathcal{C} is an object X^* (resp. *X) equipped with maps $\epsilon : X \otimes X^* \rightarrow I$ and $\eta : I \rightarrow X^* \otimes X$ (resp. $e : {}^*X \otimes X \rightarrow I$ and $h : I \rightarrow X \otimes {}^*X$) such that the composites*

$$X \xrightarrow{\rho^{-1}} X \otimes I \xrightarrow{X \otimes \eta} X \otimes (X^* \otimes X) \xrightarrow{\alpha^{-1}} (X \otimes X^*) \otimes X \xrightarrow{\epsilon \otimes X} I \otimes X \xrightarrow{\lambda} X$$

and

$$X^* \xrightarrow{\lambda^{-1}} I \otimes X^* \xrightarrow{\eta \otimes X^*} (X^* \otimes X) \otimes X^* \xrightarrow{\alpha} X^* \otimes (X \otimes X^*) \xrightarrow{X^* \otimes \epsilon} X^* \otimes I \xrightarrow{\rho} X^*$$

(resp.

$$X \xrightarrow{\lambda^{-1}} I \otimes X \xrightarrow{h \otimes X} (X \otimes {}^*X) \otimes X \xrightarrow{\alpha} X \otimes ({}^*X \otimes X) \xrightarrow{X \otimes e} X \otimes I \xrightarrow{\rho} X$$

and

$${}^*X \xrightarrow{\rho^{-1}} X \otimes I \xrightarrow{{}^*X \otimes h} X \otimes (X \otimes {}^*X) \xrightarrow{\alpha^{-1}} ({}^*X \otimes X) \otimes {}^*X \xrightarrow{e \otimes {}^*X} I \otimes {}^*X \xrightarrow{\lambda} {}^*X$$

are both identity maps.

Observe that a choice of right (resp. left) dual object for each object of a (small) monoidal category \mathcal{C} extends to a contravariant monoidal functor from \mathcal{C} to its opposite category with \otimes reversed, and that there are canonical natural isomorphisms $k : (X^*) \rightarrow X$ and $\kappa : ({}^*X)^* \rightarrow X$.

The categories we consider will have *two-sided duals*. To make sense of this in the non-symmetric setting, we need

Definition 2.3 [Freyd/Yetter [FY2]] *A monoidal category is sovereign if it is equipped with a choice of left and right duals for all objects, and a (chosen) monoidal natural isomorphism $\phi : X^* \rightarrow {}^*X$ such that*

$$\phi k = (\phi^{-1})^* \kappa$$

and $\phi_I = 1_I$.

Definition 2.4 [Shum [S]] *A tortile (tensor) category is a monoidal category $\mathcal{C} = (C, \otimes, I, \alpha, \rho, \lambda)$ in which every object has a right dual, equipped moreover with natural isomorphisms $\sigma_{A,B} : A \otimes B \rightarrow B \otimes A$ (the braiding) and $\theta_A : A \rightarrow A$ (the twist) satisfying*

$$\begin{aligned} \text{the hexagons} \quad & (\tau_{A,B} \otimes C)\alpha_{B,A,C}(B \otimes \tau_{A,C}) = \alpha_{A,B,C}\tau_{A,B \otimes C}\alpha_{B,C,A} \quad \text{for } \tau = \sigma^{\pm 1} \\ \text{balance} \quad & \theta_{A \otimes B} = \sigma_{A,B}\sigma_{B,A}(\theta_A \otimes \theta_B) \\ \theta \text{ self-dual} \quad & \theta_{A^*} = \theta_A^* \end{aligned}$$

Of course, the presence of a braiding makes right duals into left duals by $e = \sigma^{-1}\epsilon$ and $h = \eta\sigma$. However, these are not two-sided duals in the sense of Definition 2.3 unless the category satisfies the balance axiom. Indeed, we have

Proposition 2.5 [Deligne [D]] (cf. Yetter [Y1]) *A braided monoidal category with right duals for all objects is balanced if and only if the category is sovereign with the chosen right duals and the left duals of the previous paragraph. More precisely, a choice of twist is equivalent to a choice of the natural isomorphism in Definition 2.3.*

Since our categories will be tortile, we will consider chosen right duals as two-sided duals under the structure of the previous Proposition.

In what follows, we will use a diagrammatic notation, similar to Penrose's [P] notation for tensors, for maps in our categories (see **Appendix on Diagrammatic Notation** below). Its use is justified by the following theorem of Shum [S] (cf. also Freyd/Yetter [FY2], Joyal/Street [JS2], Reshetikhin/Turaev [RT], Yetter[Y1]):

Theorem 2.6 [Shum [S]] *The tortile category freely generated by a single object is monoidally equivalent to the category of framed tangles.*

The second sort of structure we require involves the linear and abelian structure on the category.

Definition 2.7 *An object X in a K -linear category \mathcal{C} is simple if $\mathcal{C}[X, X]$ is 1-dimensional.*

Definition 2.8 *A K -linear abelian category \mathcal{C} is completely reducible if every object is isomorphic to a direct sum of simple objects, and a completely reducible category is semisimple if there are only finitely many isomorphism classes of simple objects. If \mathcal{C} is equipped with an exact monoidal structure, we also require that the monoidal identity object I be simple.*

In what follows we will be concerned with K -linear semisimple abelian categories equipped with an exact tortile structure (for K a field). For brevity we refer to these as semisimple tortile categories over K .

Lemma 2.9 *If S is a simple object in any category \mathcal{C} over K , then for any object X $\mathcal{C}[X, S]$ and $\mathcal{C}[S, X]$ are canonically dual as vector-spaces.*

proof: The composition map $\circ : \mathcal{C}[S, X] \otimes \mathcal{C}[X, S] \rightarrow \mathcal{C}[S, S] \cong K$ defines a non-degenerate bilinear pairing. \square

Lemma 2.10 *Let \mathcal{C} be any semisimple category over K with \mathcal{S} a family of representatives for the isomorphism classes of simple objects in \mathcal{C} . If X is any object of \mathcal{C} , then a choice of bases $b_{1,S}, \dots, b_{d_S,S} \subset \mathcal{C}[X, S]$ for each $S \in \mathcal{S}$ (where $d_S = \dim_K \mathcal{C}[X, S]$) determines a direct sum decomposition*

$$X = \bigoplus_{S \in \mathcal{S}} \bigoplus_{i=1}^{d_S} S.$$

in which the $b_{i,S}$'s are the projections onto the direct summands, and there are splittings $\overline{b_{i,S}}$ satisfying

$$\sum_{S \in \mathcal{S}} \sum_{i=1}^{d_S} b_{i,S} \overline{b_{i,S}} = 1_X$$

and $\overline{b_{i,S}} b_{j,T}$ is the zero map from S to T , unless $(i, S) = (j, T)$, in which case it is 1_S .

proof: Now, by the definition of semisimplicity, X admits a direct sum decomposition of the form given, though not *a priori* having the $b_{i,S}$'s as projections. Let $p_{i,S}$ (resp. $\overline{p_{i,S}}$) denote the projections (resp. inclusions) of the summands in this direct sum decomposition. Now for each $S \in \mathcal{S}$, $\{p_{i,S}\}$ form a basis for $\mathcal{C}[X, S]$, while $\{\overline{p_{i,S}}\}$ form a basis for $\mathcal{C}[S, X]$ which is the dual basis under the identification of the previous lemma. But if B is the change of basis matrix transforming the $p_{i,S}$'s to the $b_{i,S}$'s then B^{-1} transforms the $\overline{p_{i,S}}$'s to the $\overline{b_{i,S}}$'s, and thus the $b_{i,S}$'s are the projections for a (generally different) direct sum decomposition. \square

We adopt the convention that if we have a basis of $\mathcal{C}[X, S]$ or of $\mathcal{C}[S, X]$ for S any simple object, then for any basis element, x , \overline{x} is the corresponding element of the dual basis, and thus $\overline{\overline{x}} = x$.

Definition 2.11 *If $f : X \rightarrow X$ is any endomorphism in a tortile category \mathcal{C} over K then the trace of f , denoted $tr(f)$, is the map $h(f \otimes 1_{X^*})\varepsilon$, or equivalently, the corresponding element of K under the identification of $\mathcal{C}[I, I]$ with K . The dimension of an object X is $dim(X) = tr(1_X)$.*

The name trace follows from the following, originally proved in the symmetric case by Kelly and Laplaza [KL]:

Proposition 2.12 *In any tortile category over K , if $f : X \rightarrow Y$ and $g : Y \rightarrow X$ then*

$$tr(fg) = tr(gf).$$

The following lemma is an immediate consequence of the coherence theorem of Shum [S]:

Lemma 2.13 *If X is any object in a tortile category over K , and X^* is its dual object, then*

$$dim(X) = dim(X^*).$$

On the other hand in the presence of the additive and linear structure on a semisimple category over K we have

Lemma 2.14 *If X and Y are objects in a semisimple tortile category over K then*

$$dim(X \oplus Y) = dim(X) + dim(Y).$$

proof: It follows from the exactness of $(\)^*$ that $h_{X \oplus Y} = \delta_I(h_X \oplus h_Y)$ and $\varepsilon_{X \oplus Y} = (\varepsilon_X \oplus \varepsilon_Y) +$. \square

Lemma 2.15 *If X and Y are objects in a semisimple tortile category over K then*

$$\dim(X \otimes Y) = \dim(X)\dim(Y).$$

proof: It is immediate from the definition of dimension and the coherence theorem of Shum [S] that $\dim(X \otimes Y) = \dim(X) \otimes \dim(Y)$ when the dimensions are regarded as endomorphisms of I . But for endomorphisms of I , \otimes , composition, and multiplication of coefficients of 1_I all coincide. \square

The following trivial lemma will be used throughout our construction:

Lemma 2.16 (“Schur’s Lemma”) *If X is any simple object in a semisimple tortile category over K with $\dim(X) \neq 0$ and $f : X \rightarrow X$ is any map, then f is $\frac{\text{tr}(f)}{\dim(X)}1_X$.*

proof: Since f is a scalar multiple of 1_X by simplicity, it suffices to observe that $\text{tr}(f)$ must be the multiple of $\dim(X)$ by the same scalar. \square

We shall assume in what follows that all of our semisimple tortile categories are non-degenerate in the sense that all simple objects X have $\dim(X) \neq 0$.

An important, though easy consequence of Lemma 2.16 concerns the behaviour of bases $\mathcal{B} = \{b_1, \dots, b_n\}$ and dual bases $\overline{\mathcal{B}} = \{\overline{b_1}, \dots, \overline{b_n}\}$ for $\mathcal{C}[A \otimes B, C]$ and $\mathcal{C}[C, A \otimes B]$ under dualization of one or more objects.

Even without Lemma 2.16 it is clear that $(\)^*$ carries $\overline{\mathcal{B}}$ to a basis for $\mathcal{C}[B^* \otimes A^*, C^*]$ and \mathcal{B} to the dual basis for $\mathcal{C}[C^*, B^* \otimes A^*]$.³

Similarly, without resort to Lemma 2.16 we can see that \mathcal{B} gives rise to bases for $\mathcal{C}[B \otimes C^*, A^*]$ (resp. $\mathcal{C}[A^*, B \otimes C^*]$; $\mathcal{C}[A, C \otimes B^*]$; and $\mathcal{C}[C \otimes B^*, A]$) by applying $A^* \otimes - \otimes C^*$ to the basis elements then precomposing with $\eta_A \otimes 1_{B \otimes C^*}$ and postcomposing with $1_{A^*} \otimes \epsilon_C$ (resp. applying $A^* \otimes - \otimes C^*$ to the splitting then precomposing with $1_{A^*} \otimes h_C$ and postcomposing with $e_A \otimes 1_{B \otimes C^*}$; applying $- \otimes B^*$ to the basis elements then precomposing with $1_A \otimes h_B$; applying $- \otimes B^*$ to the splittings then postcomposing with $1_A \otimes \epsilon_B$). (These are represented graphically in Figure 22.) [go through and put in ϕ 's]

What is not immediately clear is the relationship between the first and second (resp. third and fourth) of the transformed bases in the previous paragraph. In fact, a calculation using Lemma 2.16 provides the following generalization of the rules in the Kirillov-Reshetikhin [KR] formulation of $U_q(\mathfrak{sl}_2)$ -recoupling theory:

Lemma 2.17 *The bases of $\mathcal{C}[B \otimes C^*, A^*]$ and $\mathcal{C}[A^*, B \otimes C^*]$ (resp. $\mathcal{C}[C \otimes B^*, A]$ and $\mathcal{C}[A, C \otimes B^*]$) obtained by multiplying the transformed bases described two paragraphs ago by $\sqrt{\dim(A)}/\sqrt{\dim(C)}$ are splittings of each other, moreover giving the projection and inclusions of a direct sum decomposition for the given tensor product.*

proof: By application of Lemma 2.16 it suffices to show that the trace of composition of an element in the second basis of each pair with one in the first is $\dim(A^*) = \dim(A)$ (resp. $\dim(A)$) if the elements are the multiple of the transformation of an element of \mathcal{B} and its splitting, and 0 otherwise. But this follows directly from Lemma 2.10.

We conclude with a categorical notion, introduced in [CKY2] which will be important when we consider the interpretation of the invariants constructed:

³Throughout this section, we are using the coherence theorem of Freyd/Yetter [FY2] for sovereign categories to suppress mention of certain canonical isomorphisms, for instance, between $(A \otimes B)^*$ and $B^* \otimes A^*$.

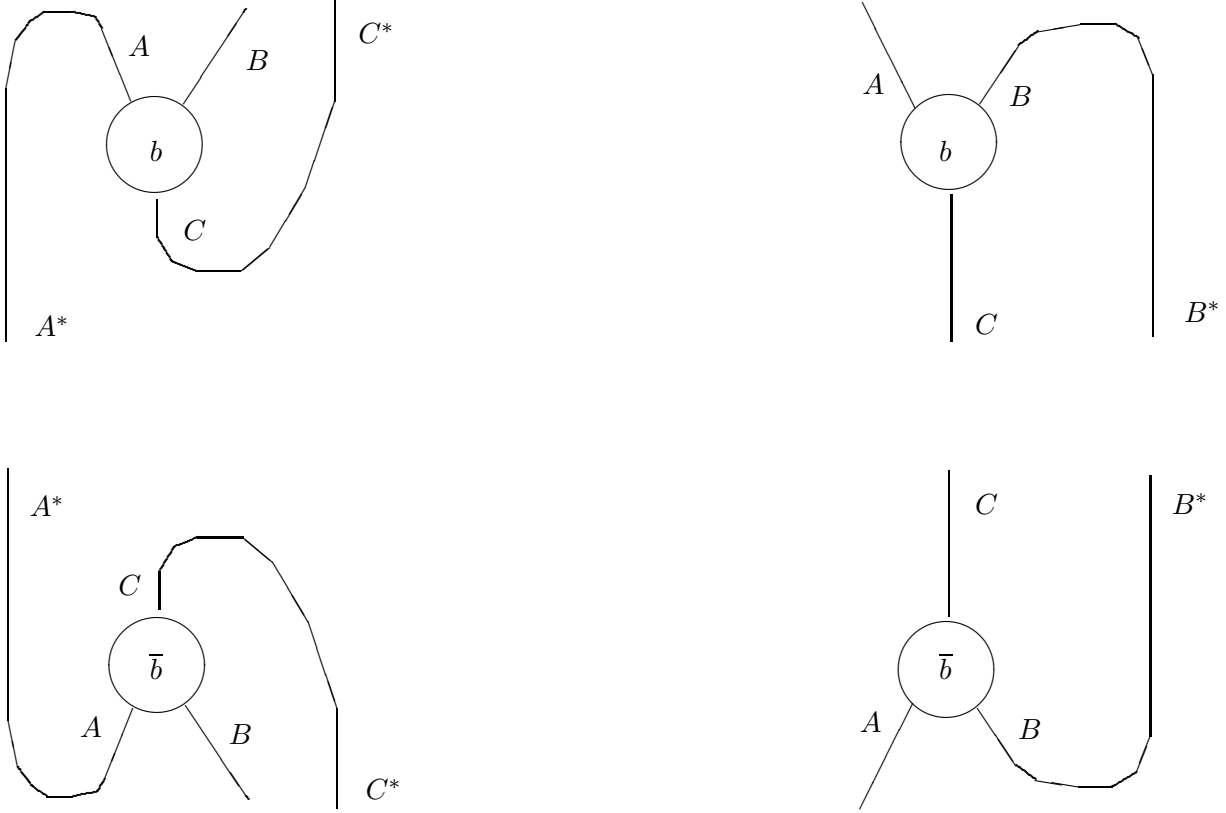


Figure 22: Transformation of bases under partial dualization

Definition 2.18 *The center $Z(\mathcal{C})$ of a braided monoidal category \mathcal{C} is the full-subcategory of all objects B with the property that*

$$\forall X \in \text{Ob}(\mathcal{C}) \sigma_{X,B} \sigma_{B,X} = 1_{X \otimes B}.$$

A braided monoidal category has trivial center if the center is the full-subcategory of objects isomorphic to a finite (possibly empty) direct sum of copies of I .

3 Coloring Triangulations and State-Sum Invariants

Throughout this section we let \mathcal{C} be a fixed semisimple tortile category, let \mathcal{S} be a chosen set of representatives for the isomorphism classes of simple objects including, as a representative of its class, the chosen monoidal identity object I , and let \mathcal{B} be a choice for each triple of elements of $a, b, c \in \mathcal{S}$ of a basis \mathcal{B}_c^{ab} for the hom-space $\mathcal{C}[a \otimes b, c]$ and by abuse of notation the disjoint union of these bases. Assume without loss of generality that the choice of dual objects has been made so that $(-)^*$ induces an involution on \mathcal{S} . For the reader who has skipped Subsection 2.2, the specific example of $\mathcal{C} = \text{Rep}(U_q(\mathfrak{sl}_2))$, $\mathcal{S} = \{0, \dots, r-2\}$ and \mathcal{B}_c^{ab} given by choosing the KR vertex with upward legs labelled a and b and downward leg labelled c should be considered. Notes directed to readers interested in this level of generality will occur from time to time. The translation from KR to TL recoupling theory is given in Subsection 5.1.

If \mathbf{T} is a triangulation of a 4-manifold M , we let $\mathbf{T}_{(i)}$ denote the set of (non-degenerate) i -simplices of the triangulation. In what follows we will be concerned with ordered triangulations, that is triangulations equipped with total orderings of their vertices.

We are now in a position to define the colorings which index our state-sums.

Definition 3.1 *A CSB-coloring λ (or simply a coloring if no confusion is possible) of an ordered triangulation of a 4-manifold is a triple of maps*

$$(\lambda : \mathbf{T}_{(2)} \cup \mathbf{T}_{(3)} \longrightarrow \mathcal{S}, \lambda^+ : \mathbf{T}_{(3)} \longrightarrow \mathcal{B}, \lambda^- : \mathbf{T}_{(3)} \longrightarrow \mathcal{B})$$

such that $\lambda^+ \{a, b, c, d\} \in \mathcal{B}_{\lambda \{a, b, c, d\}}^{\lambda \{b, c, d\}, \lambda \{a, b, d\}}$ and $\lambda^- \{a, b, c, d\} \in \mathcal{B}_{\lambda \{a, b, c, d\}}^{\lambda \{a, c, d\}, \lambda \{a, b, c\}}$, where $a < b < c < d$ in the ordering on the vertices. We denote the set of CSB-colorings of an ordered triangulation \mathbf{T} by $\Lambda_{\text{CSB}}(\mathbf{T})$.

Readers interested in the $U_q(\mathfrak{sl}_2)$ case only should note that in that case, the content of a coloring is given entirely by a choice of $\lambda : \mathbf{T}_{(2)} \cup \mathbf{T}_{(3)} \longrightarrow \mathcal{S}$ for which the labels on the positive (resp. negative) part of the boundary of each 3-simplex couple to the label on the 3-simplex.

In what follows, we let $N = \sum_{A \in \mathcal{S}} \dim(A)^2$ and $n_i = |\mathbf{T}_{(i)}|$

Now, given an ordered triangulation \mathbf{T} of a 4-manifold, we can assign to each coloring λ a number $\ll \lambda \gg$ defined by

$$\ll \lambda \gg = N^{n_0 - n_1} \prod_{\text{faces } \sigma} \dim(\lambda(\sigma)) \prod_{\text{tetrahedra } \tau} \dim(\lambda(\tau))^{-1} \prod_{\text{4-simplices } \xi} \|\lambda, \xi\|$$

where $\|\lambda, \xi\|$ is given by the endomorphism of I graphically in Figure 23 if the orientation of ξ induced by the ordering of the vertices is the same as the ambient orientation, and by the endomorphism of I represented graphically by the network obtained from that in Figure 23 by mirror-imaging the network, applying $(-)^*$ to all object labels and $\overline{(-)^*}$ to all labels by maps in \mathcal{B} .

For readers interested in the $U_q(\mathfrak{sl}_2)$ case, the picture is simpler: the nodes are KR vertices with legs as shown in Figure 23 and the dualizing of labels is unnecessary (since all representations of $U_q(\mathfrak{sl}_2)$ are self-dual).

The main result of this section is then

Theorem 3.2 *The state-sum*

$$CY_{\mathcal{C}}(M) = \sum_{\lambda \in \Lambda_{\text{CSB}}(\mathbf{T})} \ll \lambda \gg$$

is independent of the choice of ordered triangulation \mathbf{T} , of representative simple objects \mathcal{S} and of bases \mathcal{B} . Thus for any semisimple tortile category \mathcal{C} , $CY_{\mathcal{C}}(-)$ is an invariant of piecewise-linear 4-manifolds. In the case of $\mathcal{C} = \text{Rep}(U_q(\mathfrak{sl}_2))$, the invariant is the original Crane-Yetter invariant of [CY].

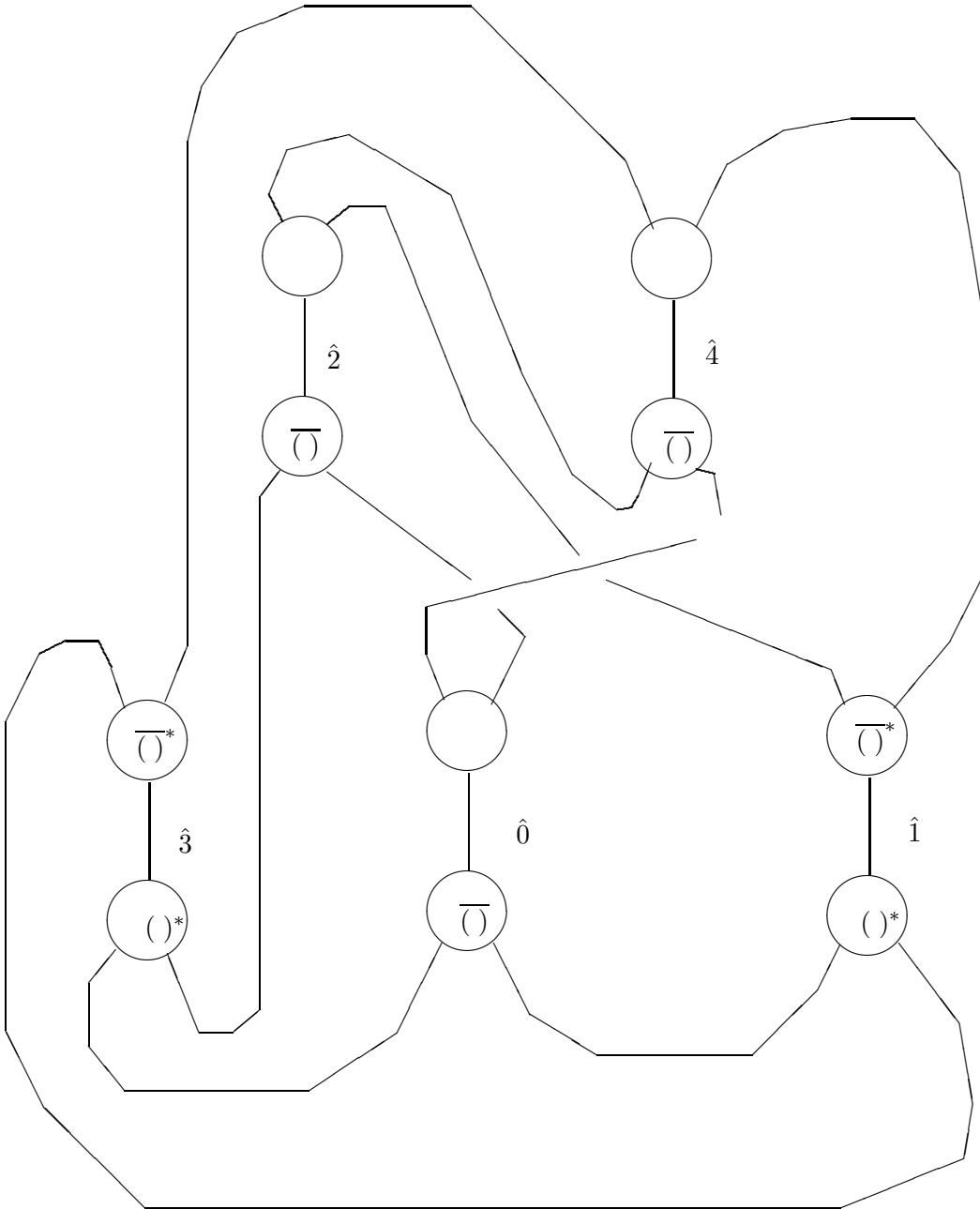


Figure 23: The generalized 15-j symbol associated to a correctly oriented vertex-ordered 4-simplex

To prove this we use an auxiliary notion

Definition 3.3 *A d -blob is a d -cell equipped with an ordered triangulation of its boundary.*

Although the initial verification of the invariance of the Crane-Yetter state-sum [CY] was carried out using Pachner’s moves, the notion of blobs provides an alternative method for verifying that state-sums on triangulations give rise to PL-manifold invariants: in general, one must show that the state-sum associated to any blob with an arbitrary extension of the triangulation to the interior and fixed initial data on the boundary is independent of the extension of the triangulation to the interior.

Observe that Pachner’s moves in any dimension are of this form. At first, it might appear that the method suggested above is worse than verifying Pachner’s moves. However, in our case (and potentially in the case of more refined state-sums) the use of blobs allows a uniform inductive proof. Indeed, it follows from general principles enunciated in Yetter [Y6] that any state-summation on ordered triangulations in which weights are assigned to simplices (or simplicial flags with suitable compatibilities imposed for shared simplices) must satisfy a “blob lemma” of this sort if it is to be a PL-invariant. It will depend on the exact circumstances whether it will be easier to verify this “blob lemma” inductively or to check Pachner’s moves.

It should also be noted, that the use of blobs provides an immediate check for feasibility of finding normalization factors on lower-dimensional simplices (or simplicial flags) to make a proposed state-sum topologically invariant: one must be able to find a prescription for a weight on a labelled blob (for example as a product or ratio of recombination diagrams) which restricts to the proposed weight on an ordered 4-simplex.

In the present case, we set up the induction (carried out in the proof of Lemma 3.5) as follows: first, we describe a network naming an endomorphism of I , and hence a number, for any 4-blob in an oriented 4-manifold, then show that the state-sum can be rewritten in terms of a decomposition into blobs (as observed above, without regard to the triangulation of their interiors).

This will complete the proof of invariance, and independence from the triangulation, while independence from the ordering of the vertices will follow from the simple expedient of observing that the star of a vertex is a 4-blob, rewriting with the vertex missing, then reversing the process to insert the vertex somewhere else in the ordering.

To construct our networks associated to 4-blobs, first notice that a vertex ordering on a tetrahedron in the boundary of a 4-blob (or 4-simplex as a special case) together with the orientation gives rise to a chosen side of the tetrahedron.

(Specifically, in a local coordinate system identified with a ball in \mathbf{R}^4 the orientation gives a way to choose a fourth vector orthogonal to any given ordered triple of vectors —here the vectors are the tangents to the edges from the lowest numbered vertex to the others in order. We only care about the side the fourth vector lies on, inside the blob or outside, so the result doesn’t depend on what orientation preserving map we used to identify the chart with the ball.)

Now, place the highest numbered vertex at ∞ , identify the rest of the bounding \mathbf{S}^3 with \mathbf{R}^3 , and choose a plane to project on and vertical and horizontal directions in the plane. In each 3-simplex place a vertical “dumbbell” (as in the network for the generalized $15j$ symbol in Figure 23 with ends representing places to be colored with maps, and a bar representing a place to be colored with a simple object) in a plane parallel to the plane of projection. Add arcs connecting the “dumbbells” so that for tetrahedra with inward normals the bottom right (resp. top right, bottom left, top left) is connected through the face obtained by omitting the lowest (resp. second, third, highest) numbered vertex of the tetrahedron, while for tetrahedra with outward normals, proceed as above, but reversing left and right. Finally, in tetrahedra with inward normal vectors place an overline in the lower end of the “dumbbell” (to indicate that the map here will be the splitting of the color from \mathcal{B}), while in those with outward normal vectors, place an overline and a * in the upper end of the “dumbbell” and

a * in the lower end (to indicate that the map here will be the dual of the splitting, respectively the dual, of the color from \mathcal{B}). For brevity it will be convenient to refer to the “dumbbells” as “inward” or “outward dumbbells” according to the structure of connections and labellings.

Observe

Lemma 3.4 *The generalized 15j symbol of Figure 23 is precisely the network associated to a 4-simplex whose order-orientation agrees with the induced orientation by the procedure just outlined.*

proof: It suffices to observe that the normal vector induced on $\hat{0}, \hat{2}, \hat{4}$ are opposite to those induced on $\hat{1}, \hat{3}$, and that the agreement of orientations implies that the normal vector on $\hat{0}$ is on the same side of $\hat{0}$ as 4, and thus inward.

Finally we are in a position to state the key lemma in the proof. In its proof, we will regard the state-sum as an evaluation of linear combinations of colored embedded trivalent (ribbon) graphs interpreted in the now standard way (cf. Reshetikhin/Turaev [RT]).

Lemma 3.5 “The Blob Lemma” *If M is a 4-manifold equipped with an ordered triangulation \mathbf{T} , and D is a 4-blob formed by the union of 4-simplices in \mathbf{T} , then the state-sum*

$$\sum_{\lambda \in \Lambda_{CSB}(\mathbf{T})} N^{n_0 - n_1} \prod_{\text{faces } \sigma} \dim(\lambda(\sigma)) \prod_{\substack{\text{tetrahedra} \\ \tau}} \dim(\lambda(\tau))^{-1} \prod_{\text{4-simplices } \xi} \|\lambda, \xi\|$$

decomposes as

$$\sum_{\lambda \text{ a coloring of } \mathbf{T}|_{\partial D}} \left[\sum_{\substack{\mu \text{ a coloring} \\ \text{of } \mathbf{T}|_D \text{ ex-} \\ \text{tending } \lambda}} N^{|\mathbf{T}(\mathbf{0}) \cup \text{int}(D)| - |\mathbf{T}(\mathbf{0}) \cup \text{int}(D)|} \prod_{\substack{\text{faces} \\ \sigma \subset \text{int}(D)}} \dim(\mu(\sigma)) \prod_{\substack{\text{tetrahedra} \\ \tau \subset \text{int}(D)}} \dim(\mu(\tau))^{-1} \prod_{\substack{\text{4-simplices} \\ \xi \subset D}} \|\mu, \xi\| \right]$$

$$\times \left[\sum_{\substack{\nu \text{ a coloring of} \\ \mathbf{T}|_{M \setminus \text{int}(D)} \\ \text{extending } \lambda}} N^{|\mathbf{T}(\mathbf{0}) \setminus \text{int}(D)| - |\mathbf{T}(\mathbf{0}) \setminus \text{int}(D)|} \prod_{\substack{\text{faces} \\ \sigma \subset M \setminus \\ \text{int}(D)}} \dim(\nu(\sigma)) \prod_{\substack{\text{tetrahedra} \\ \tau \subset M \setminus \\ \text{int}(D)}} \dim(\nu(\tau))^{-1} \prod_{\substack{\text{4-simplices} \\ \xi \subset M \setminus \\ \text{int}(D)}} \|\nu, \xi\| \right]$$

and for each λ the first factor (the sum on μ) is equal to the evaluation of the network associated to the boundary of the 4-blob D .

proof: We proceed by induction on the number n of 4-simplices in D . If $n = 1$ there is nothing to show, by the preceding lemma.

Now suppose $n > 1$, and we have shown for the lemma for all 4-blobs with $n - 1$ 4-simplices. Select a 4-simplex σ in D which intersect the boundary in a cell of dimension 3. Then $D' = \overline{D} \setminus \overline{\sigma}$ is a 4-blob. Now observe that $D' \cap \overline{\sigma}$ is a union of closed 3-simplices of \mathbf{T} , and that those assigned “inward dumbbells” in one of D' or $\overline{\sigma}$ are assigned “outward dumbbells” in the other and vice-versa. Similarly, the pattern of connections between the “dumbbells” in shared tetrahedra (and from shared tetrahedra out to unspecified “dumbbells”) will be mirror images.

To complete the proof, it suffices to show that a local evaluation of the part of the diagram describing the state-sum which includes the contributions of σ , and all simplices in $D' \cap \sigma$ is equal to the local evaluation of the remaining faces of σ . A series of diagrammatic calculations verifies this.

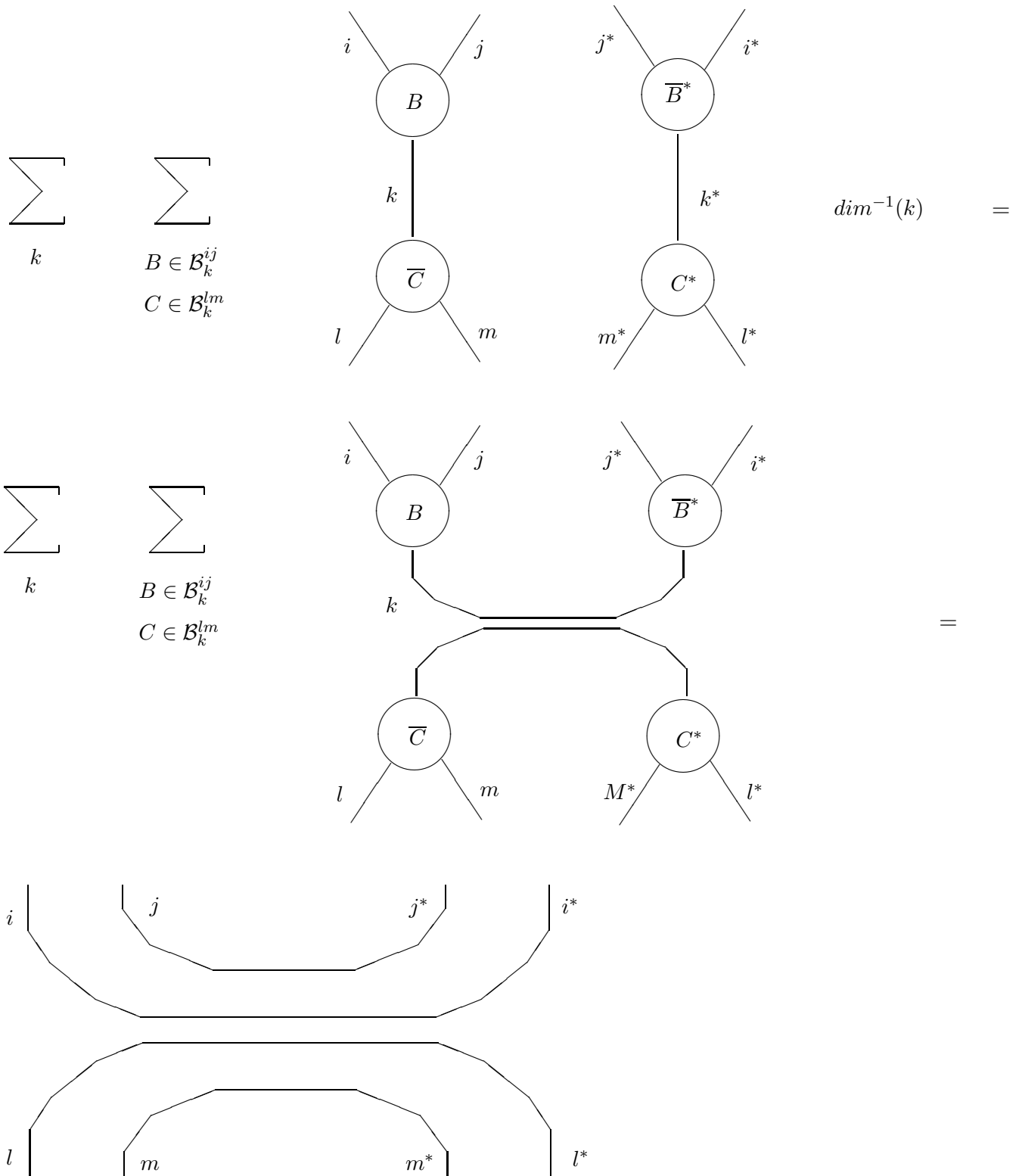


Figure 24: Joining blobs which share one tetrahedron

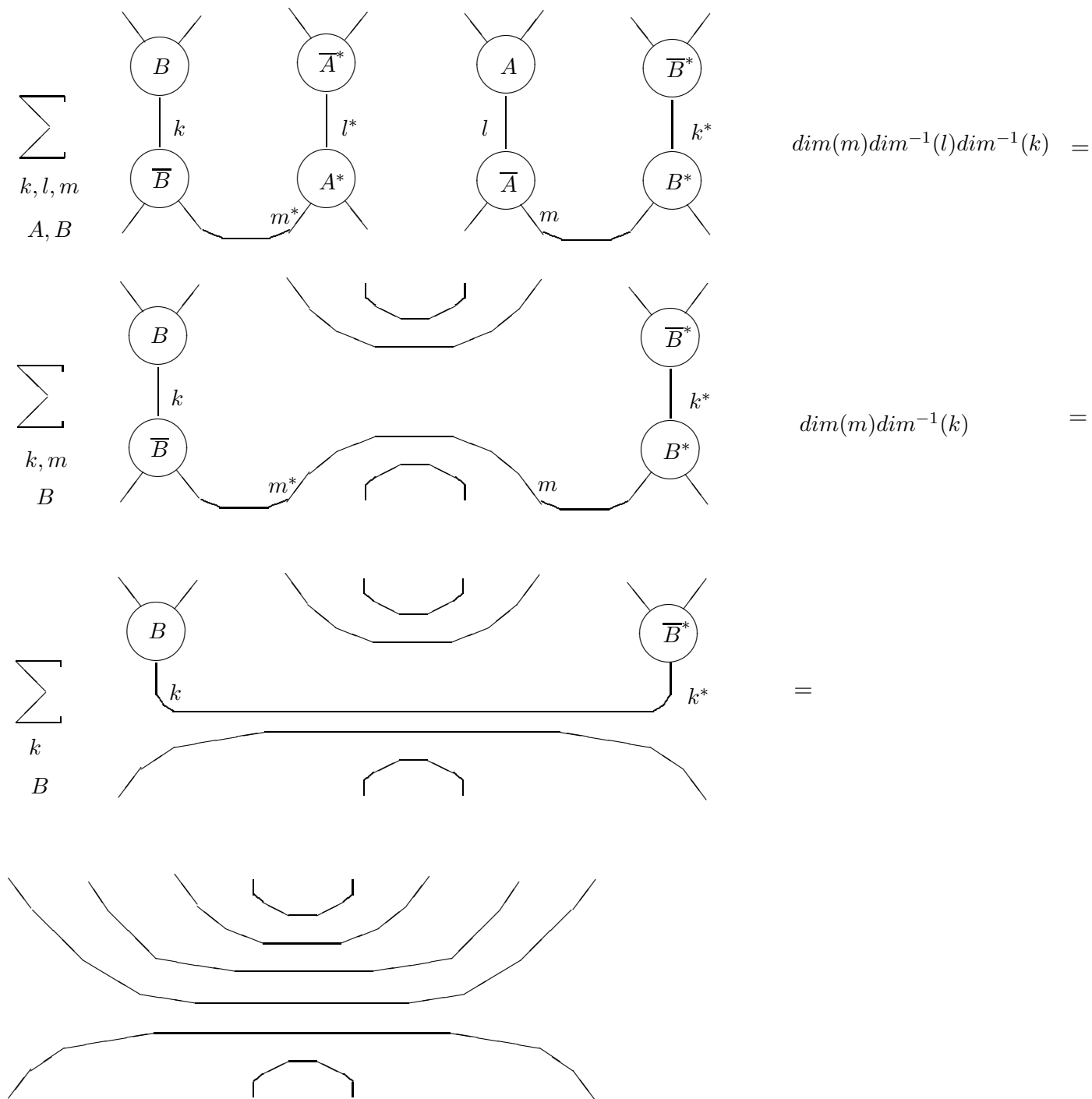


Figure 25: One case of joining blobs which share two tetrahedra

A sample of the calculations are given in Figures 24, 25, 26, 27, 28 and 29. The others (in which other portions of the 15-j symbol are involved) are completely analogous, and are left to the reader. Only for the first (Figure 24) do we give a detailed description of where labels are drawn from.

Independence of the choice of representative simple objects will follow by inserting isomorphisms between the chosen representative objects around each of the nodes in the generalized 15-j symbol, and the following lemma, which shows independence from the choice of bases.

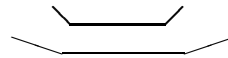
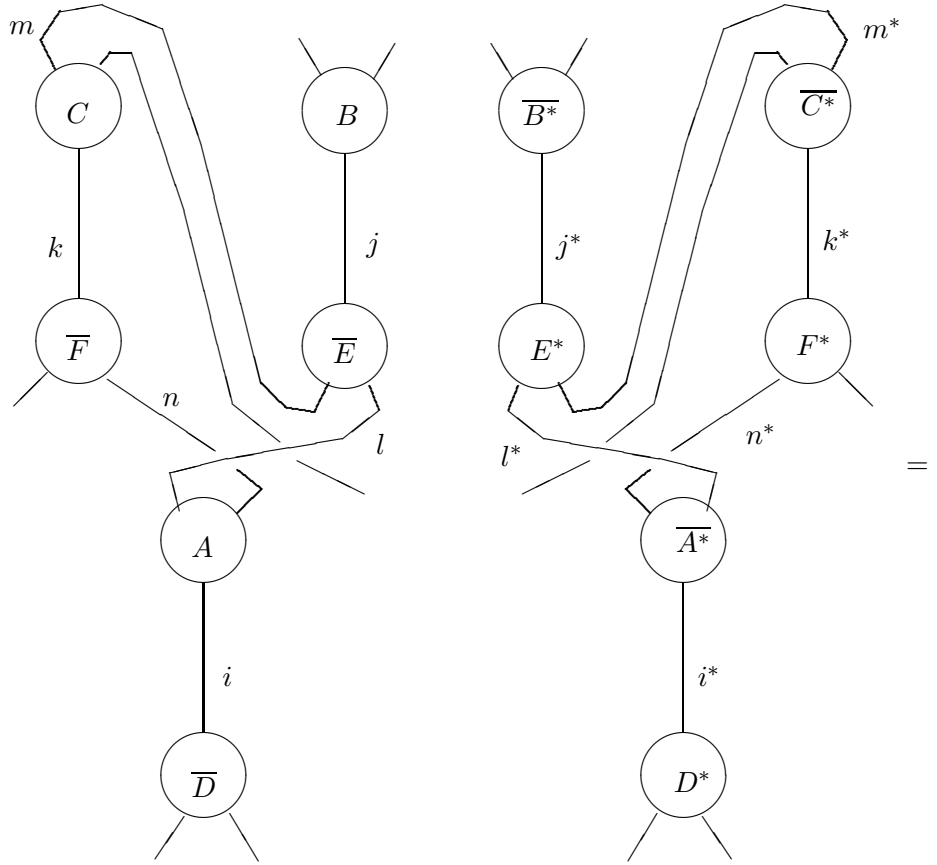
Lemma 3.6 *The state-sum is invariant under the change of bases from which the map components of the labels are chosen on any one tetrahedron (and hence on all).*

proof: It suffices to show that a local evaluation of the diagram describing the state-sum including all occurrences of the basis elements chosen on a particular tetrahedron is independent of the choice of basis. Observe that this follows immediately from the first of the calculations in the proof of Lemma 3.5 (Figure 24).

This completes the proof of Theorem 3.2.

$$\sum \frac{\dim(l)\dim(m)\dim(n)}{N\dim(i)\dim(j)\dim(k)}$$

i, j, k
 l, m, n
 A, B, C
 D, E, F



$$\sum \frac{\dim(m)\dim(n)}{N\dim(k)}$$

m, n, k
 C, F

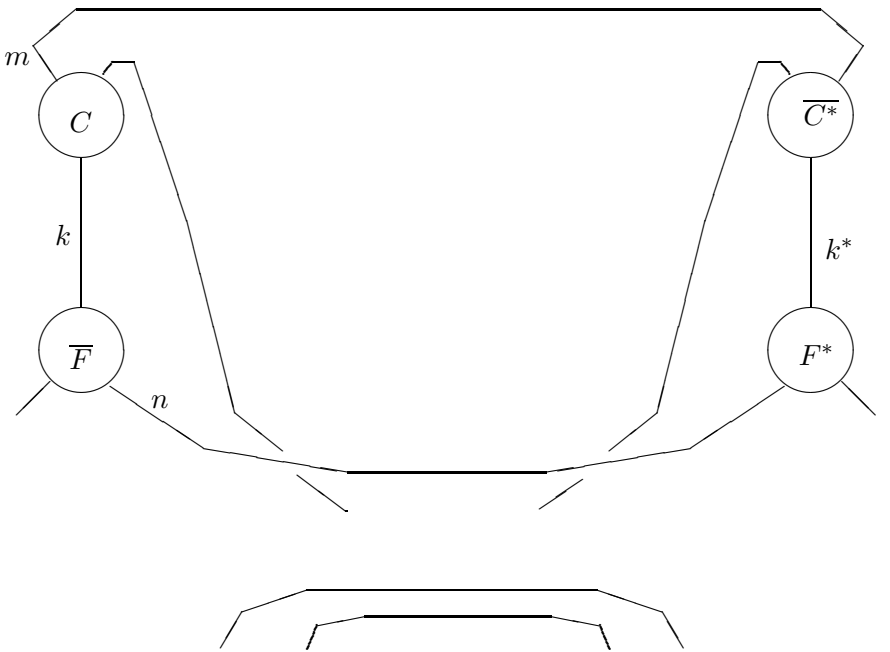


Figure 26: One case of joining blobs that share three tetrahedra (beginning)

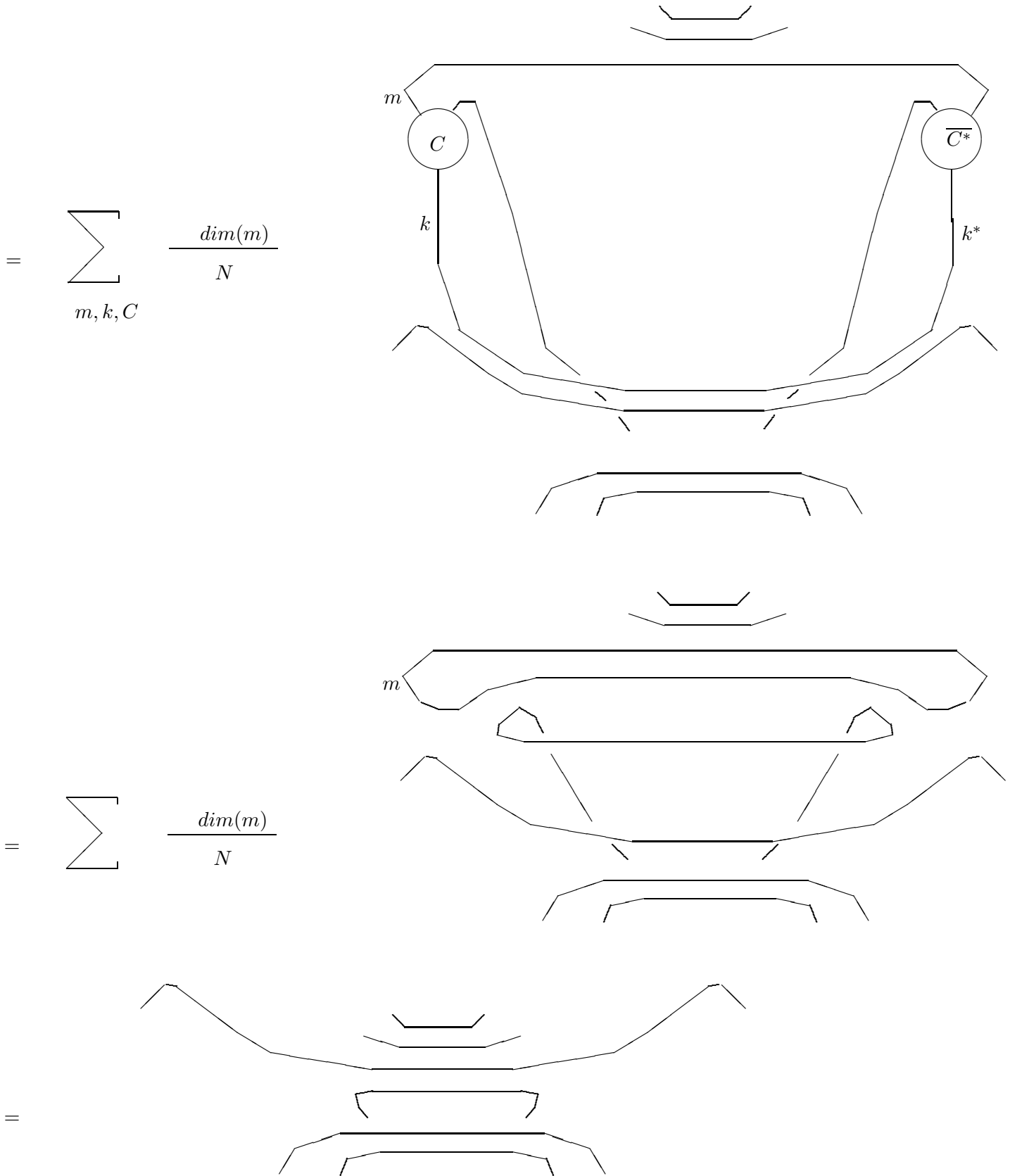


Figure 27: One case of joining blobs which share three tetrahedra (conclusion)

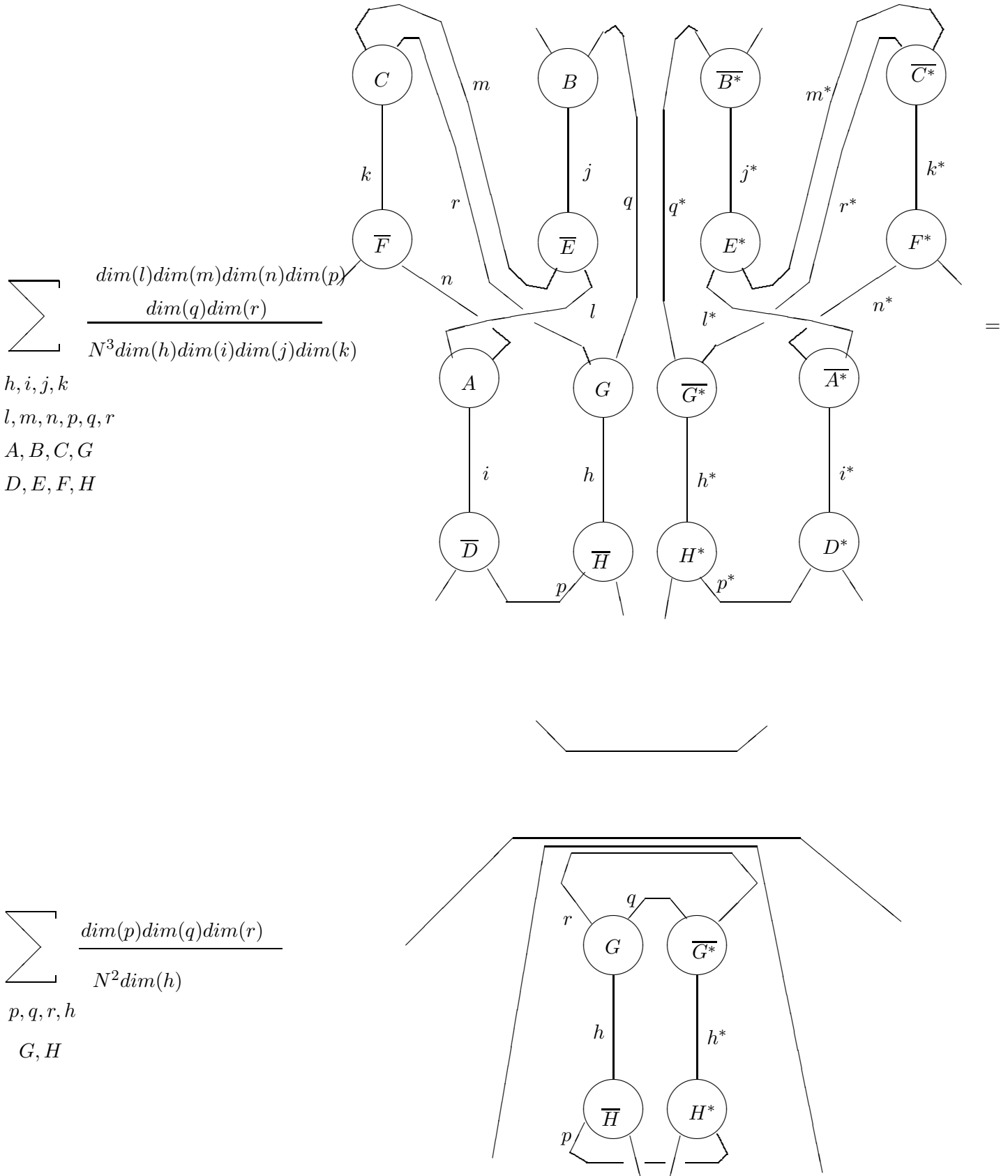
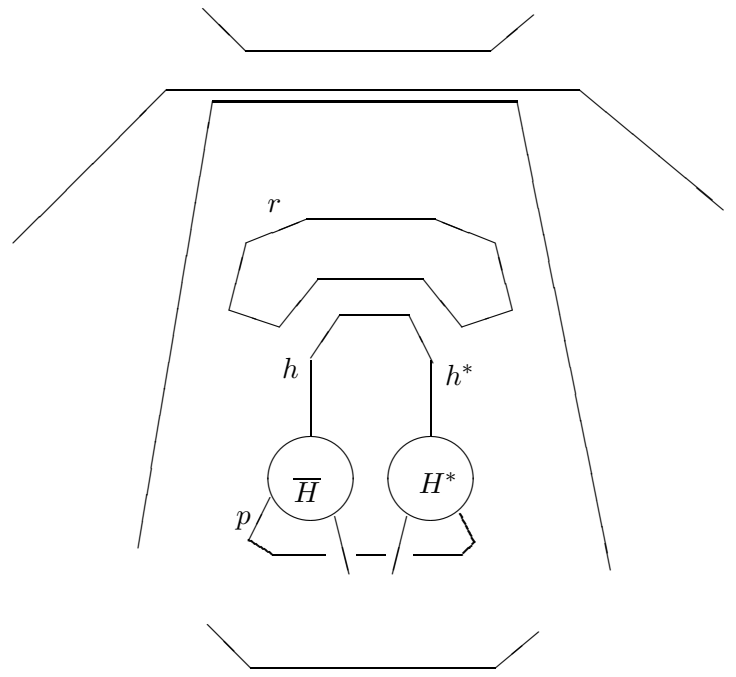


Figure 28: One case of joining blobs which share four tetrahedra (beginning)

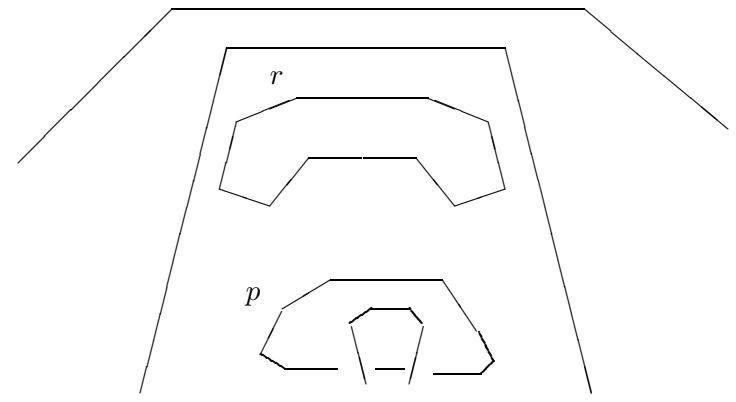
=

$$\sum_{p, r, h, H} \frac{\dim(p)\dim(r)}{N^2}$$



=

$$\sum_{p, r} \frac{\dim(p)\dim(r)}{N^2}$$



=

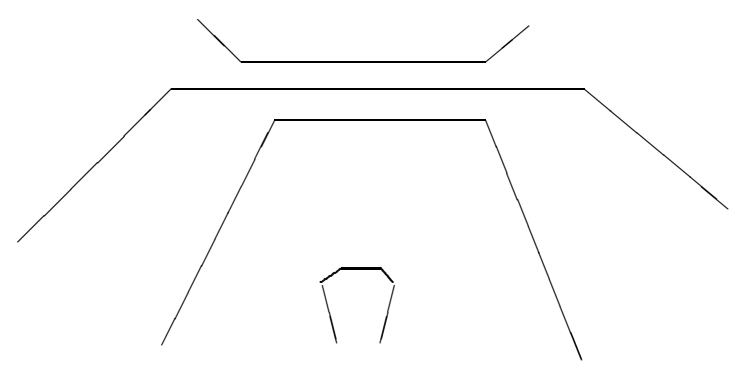


Figure 29: One case of joining blobs which share four tetrahedra (conclusion)

4 Surgical Versions and an Aside About 3-Manifold Invariants

At about the same time as the announcement of [CY] appeared, B. Broda [B] announced the construction of a 4-manifold invariant calculated from a surgery description of the 4-manifold (cf. Kirby [Ki]) by a framed link with a distinguished unlink.

In this section, we describe analogs of Broda’s invariant for arbitrary semisimple tortile categories and of the generalized Reshetikhin/Turaev 3-manifold invariants of Turaev [T] (without the “modularity” assumption on the category). The detour through 3-manifold invariants is necessary, as the generalization of Roberts’ results relating the surgical and state-sum invariants, and interpreting the former in terms of signature requires the use of the 3-manifold invariants.

The key here is the idea that in addition to being able to label components of a framed link diagram with objects of a k -linear tortile category, and thereby (via the freeness theorem of Shum [S]) interpret the diagram as giving an endomorphism of I (that is a number, when I is simple), we can also label them with linear combinations of objects (again obtaining a number).⁴

If the linear combination used to label the components is carefully chosen, the resulting framed link invariant will be invariant under handle-sliding, and thus (upon suitable normalization) can be turned into an invariant of the 3- or 4-manifold described by surgery on the link (a little care must be taken in the 4-manifold case to correctly deal with the distinguished unlink whose curves represent places to “hollow out a 2-handle”, equivalent to attaching a 1-handle, but we will deal with that when the time comes.)

The key here is a generalization of the elegant demonstration given in Lickorish [L] (based on ideas of Roberts and Viro, cf. also Kauffman/Lins [KaLi]) that the linear combination of the simple objects in the semisimple subquotient category of $Rep(U_q(sl_2))$ at a root of unity with their (internal or quantum) dimensions as coefficients gives rise to a framed link invariant which is invariant under handle-sliding.

In fact the phenomenon is quite general:

Proposition 4.1 *If \mathcal{C} is any semisimple k -linear tortile category with \mathcal{S} and \mathcal{B} as in the previous section, then*

where $b \in \mathcal{S}$ and c is any object, and the box represents any map built out of the structural maps for the tortile structure (thus representable by a framed tangle).

proof: The proof is the diagrammatic calculation given in Figure 30. The first step is an application of Lemma 2.10, the second uses the naturality (and dinaturality) properties of the structure maps, and the third is an application of Lemma 2.17.

Thus, the framed link invariant arising by labelling each strand of the link with the linear combination

⁴The *very* categorically minded will recognize that we are really labelling each strand with a direct sum of objects, and placing on each strand a node with the map which multiplies each direct summand by the coefficient. This view of the construction will doubtless seem a bit stretched and confusing to most readers, but may be essential to generalizations to more non-commutative “Hopf categories”—cf. Crane/Frenkel [CF]

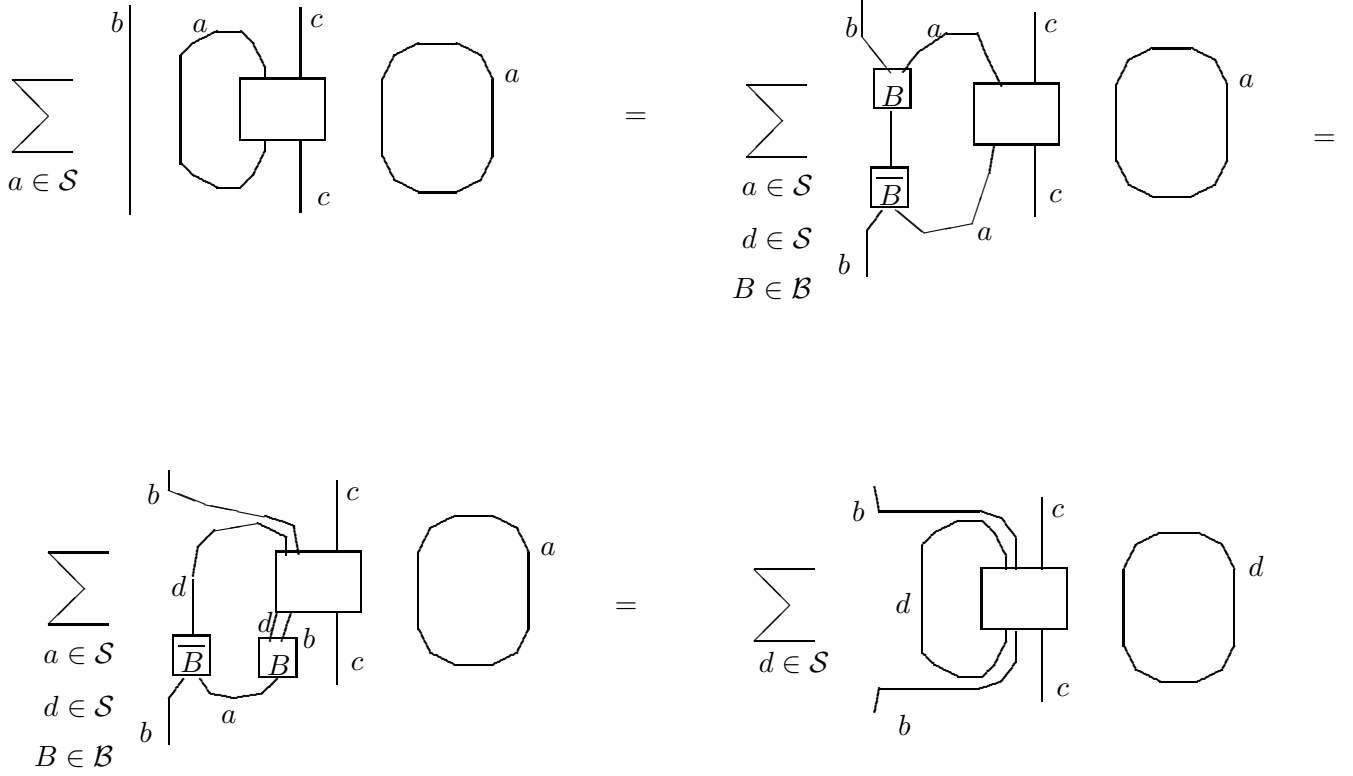


Figure 30: Proof of Proposition 4.1

$$\omega_{\mathcal{C}} = \sum_{s \in \mathcal{S}} \dim(s)s$$

is invariant under handle-sliding, regardless of what semisimple tortile category \mathcal{C} we use. (It is a trivial to see that the invariant does not depend on the choice of \mathcal{S} .)

Now, if we let a_+ (resp. a_-) be the value of the $+1$ - (resp. -1 -)framed $\omega_{\mathcal{C}}$ -labelled unknot, and assume that \mathcal{C} satisfies

Definition 4.2 *A semisimple tortile category over a field k is 3-conformed if the values a_+ and a_- are non-zero.*

then letting $x = (a_+ a_-)^{\frac{1}{2}}$ and $y = (a_+ / a_-)^{\frac{1}{2}}$, it follows immediately from the same sort of argument given in [RT] that if M is the 3-manifold obtained as the boundary of the 4-dimensional handle-body with one 0-handle, and 2-handles attached using L , then

$$\mathcal{I}_{\mathcal{C}}(M) = \omega_{\mathcal{C}}(L)x^{-|L|}y^{-\sigma(L)}$$

depends only on the diffeomorphism type of M , where $|L|$ is the number of components of L and $\sigma(L)$ is the signature of the linking matrix. We shall call $\mathcal{I}_{\mathcal{C}}(M)$ a generalized Reshetikhin/Turaev invariant of M . Note that we have used a different non-degeneracy condition than that used by Turaev [T].

In a similar way, if we let b be the evaluation of an $\omega_{\mathcal{C}}$ -labelled Hopf link, then if W is the 4-manifold obtained by attaching 2-handles to undotted components of L , and “hollowing out 2-handles” along dotted components of L as in Kirby [Ki], then

$$\mathcal{B}_C(W) = \omega_C(L) b^{\frac{\nu(L)-|L|}{2}} N^{-\nu(L)}$$

depends only on the diffeomorphism type of W , where $|L|$ is as above and $\nu(L)$ is the nullity of the linking matrix. We will call $\mathcal{B}_C(W)$ a generalized Broda invariant. Note first that for $\mathcal{B}_C(W)$ to be defined, we need a different non-degeneracy condition:

Definition 4.3 *A semi-simple tortile category is 4-conformed if b and N are both non-zero.*

We will see in Section 6 that under hypotheses satisfied by the TL and KR categories at principal $4r^{\text{th}}$ -roots of unity, $N = b = x^2$ and a_+ and a_- are both non-zero provided N is.

In the next section, we present Roberts' analysis [Ro1] (cf. also [CKY]) of the relation between the original Crane-Yetter invariant [CY], the original Broda invariant [B], and the corresponding 3-manifold invariant, the Reshetikhin/Turaev invariant [RT], all in the TL formulation.

5 TL translation of $CY(W)$ and Roberts' Chainmail Method

5.1 Translation

The purpose of this section is to give a sketch of Justin Roberts' beautiful method of understanding the Crane-Yetter 4-manifold invariant in the case of $U_q(sl_2)$. In order to accomplish this connection we need to translate the original formulation of the Crane-Yetter invariant in terms of Kirillov-Reshetikhin recoupling into Temperley-Lieb recoupling, in that Roberts' method is cleanest in the TL theory. This translation has already been done in [CKY]. For completeness, we repeat this construction here.

First recall the general definition for a Crane-Yetter invariant:

$$CY_C(M) = \sum_{\lambda \in \Lambda_{CSB}(\mathbf{T})} \ll \lambda \gg$$

where

$$\ll \lambda \gg = N^{n_0 - n_1} \prod_{\text{faces } \sigma} \dim(\lambda(\sigma)) \prod_{\text{tetrahedra } \tau} \dim(\lambda(\tau))^{-1} \prod_{\text{4-simplices } \xi} \|\lambda, \xi\|$$

and $\|\lambda, \xi\|$ is the 15j-network appropriate to the 4-simplex ξ and the coloring λ . Recall n_0 (resp. n_1) is the number of vertices (resp. edges) in the triangulation and N is the sum of the squares of the quantum dimensions.

In the case of where our category is the truncation of $Rep(U_q(sl_2))$ at a root of unity, we choose as \mathcal{S} , the irreducible representations of $U_q(sl_2)$ at $A = \sqrt[q]{q}$ a $4r^{\text{th}}$ -root of unity, labelling them $\{0, 1, 2, \dots, r-2\}$; The bases \mathcal{B} for the hom-spaces consist of the projections and inclusions given by the KR 3-vertices; and N , the sum of the squares of the quantum dimensions, has the specific value $N = -\frac{2r}{(q-q^{-1})^2}$. ($q = \exp(i\pi/r)$).

Because the labels at the node of the 15j-symbol are uniquely determined by the labels of the arcs incident, we can regard the labelling as a coloring of faces and tetrahedra by integers (twice spins). That is, the 15j-symbol becomes in this case simply a particular KR network.

Now, we have remarked in the first part of Section 2 that there is a simple translation from KR theory to TL theory effected by the formula of Figure 19.

Recall that in Figure 19 $\theta(a, b, c)$ is the evaluation of the TL theta net with labels a, b , and c . The result of applying this translation to the 15j-symbols results in a formula for the $(U_q(sl_2))$ Crane-Yetter invariant $CY(W)$ in the TL theory:

$$CY(M) = \sum_{\lambda \in \Lambda(\mathbf{T})} \ll \lambda \gg$$

where the sum runs over all labellings of faces and tetrahedra by elements of $\{0, 1, \dots, r-2\}$ and

$$\begin{aligned} \ll \lambda \gg &= N^{n_0 - n_1} \prod_{\text{faces } \sigma} \dim(\lambda(\sigma)) \prod_{\text{tetrahedra } \tau} \dim(\lambda(\tau)) \theta(\lambda(\tau), \lambda(\tau_0), \lambda(\tau_2)) \theta(\lambda(\tau), \lambda(\tau_1), \lambda(\tau_3)) \\ &\times \prod_{\text{4-simplices } \xi} \|\lambda, \xi\|_{TL} \end{aligned}$$

Here $\|\lambda, \xi\|_{TL}$ denotes the TL 15j-symbol associated to ξ and the coloring λ , that is the network given by the diagram of Figure 23, with TL 3-vertices in place of the ends of every "dumbbell", and $\tau_0, \tau_1, \tau_2, \tau_3$ are the faces of the tetrahedron τ obtained by omitting the lowest numbered, ..., highest numbered vertex of τ in the ordering on \mathbf{T} .

This completes the translation of $CY(W)$ into the TL recoupling theory.

5.2 Roberts' Chain Mail

Roberts considers a triangulated 4-manifold W and its dual handlebody decomposition D^* . The 0-handles of D^* correspond to the 4-simplices of W ; the 1-handles of D^* correspond to the tetrahedra of W ; the 2-handles of D^* have framed attaching curves on the boundary of $M = \partial N$, where N is the union of the 0- and 1-handles of D^* —these 2-handles correspond to the faces of the triangulation of W .

Letting N' denote N with the 2-handles attached and $M' = \partial N'$, note that both M and M' are connected sums of $S^1 \times S^2$'s. By adding more $S^1 \times S^2$'s (by adding 1-handles which cancel all but one of the 0-handles of D^*), Roberts produces a surgery description of N'' by a labelled link in S^3 (cf. Kirby [Ki]), where closing up N'' by 3- and 4-handles give $W' = W \# d(S^1 \times S^3)$ for $d = n_4 - 1$ (n_4 is the number of 4-simplexes in the original triangulation on W).

The surgery curves of the presentation of N'' then take the local form shown in Figure 31 or its mirror image, with one such region occuring for each 4-simplex of W .

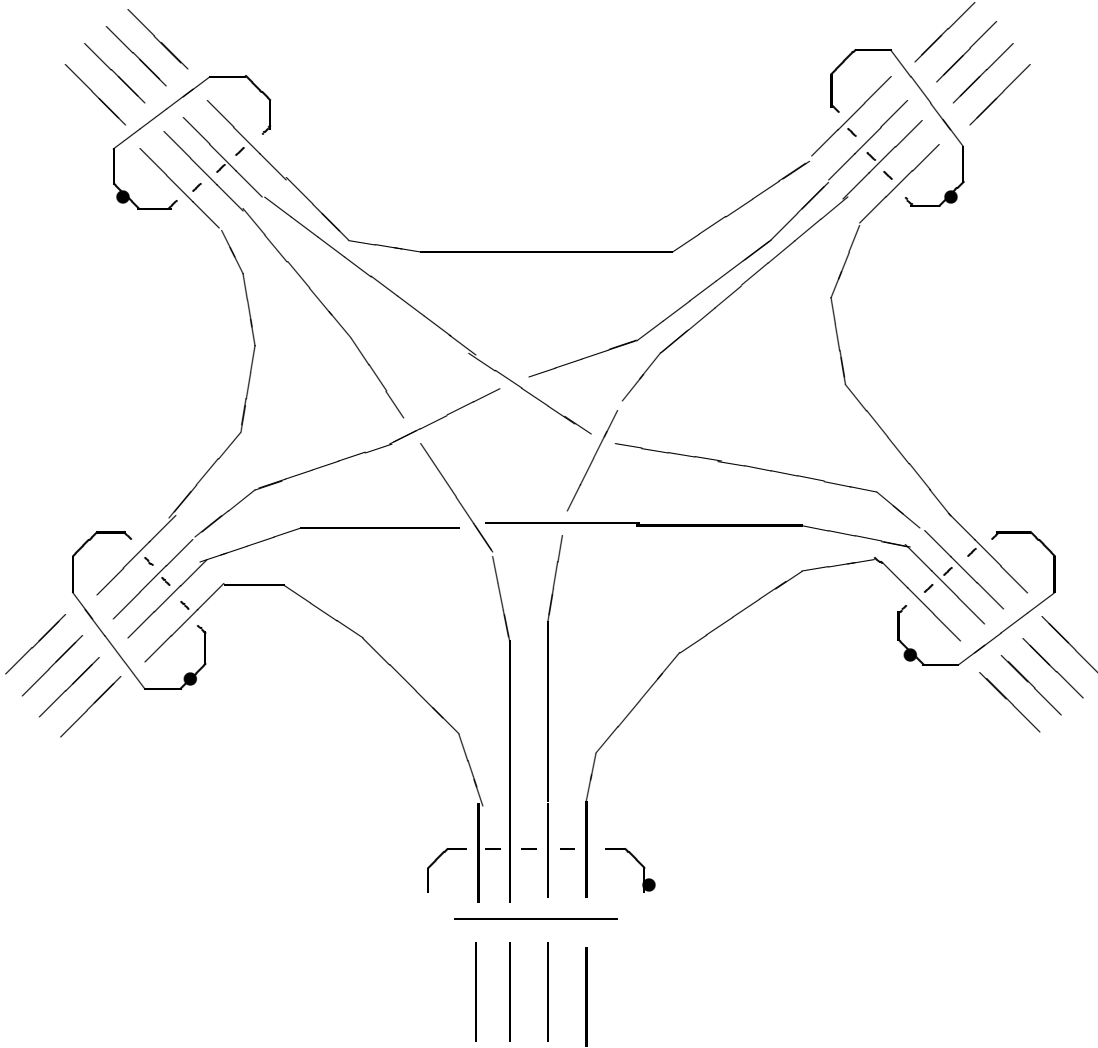


Figure 31: The Portion of Chainmail Corresponding to a 4-simplex

In Figure 31 the dotted curves are meridians corresponding to the 1-handles (recall from Kirby [Ki] that “hollowing out” a 2-handle along an unknot is equivalent to attaching a 1-handle), the other curves are (parts of) attaching curves for the 2-handles.

One can then define the (original) Broda invariant [B] of W' by labelling every curve with $\omega = \sum_{i=0}^{r-2} \Delta_i \cdot i$. Here i denotes the parallel cabling of i arcs (in blackboard framing) with a q-symmetrizer attached as in Section 2. One then normalizations of the bracket evaluation of the resulting sum by multiplying by $N^{\frac{|L|+\nu(L)}{2}}$, where $|L|$ is the number of components of the “chainmail link” L , and $\nu(L)$ is the nullity of its linking matrix. The resulting invariant is then seen to be $I(W) = \kappa^{\sigma(W')}$ where

$$\kappa = \exp\left(\frac{i\pi(-3-r^2)}{2r} - \frac{i\pi}{4}\right)$$

and $\sigma(W)$ is the signature of the 4-manifold W , but since W' is a connected sum of W with a manifold with trivial signature, $\sigma(W) = \sigma(W')$.

This would be uninteresting if it were not for the formula of Figure 32 which follows directly from Lickorish’s encirclement lemma [L],

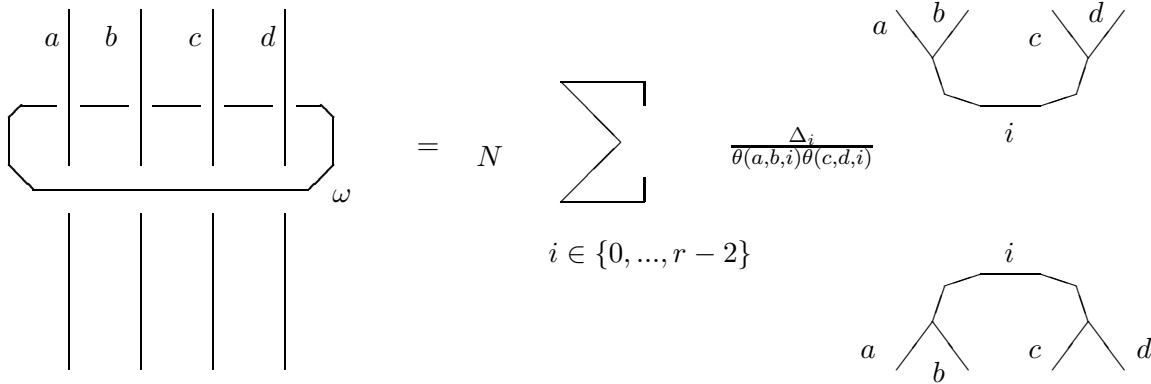


Figure 32: Using Encirclement to Cut 4 Strands

(Of course, in Figure 32 (a, b, i) and (c, d, i) must be admissible triples for a 3-vertex. This includes the condition (imposed by A being a $4r^{\text{th}}$ root of unity) that $a + b + i \leq 2r - 4$.) N is as usual the sum of the squares of the quantum dimensions.

Application of this formula to $I(W)$ rewrites it as a sum of products involving Δ_i ’s corresponding to labelled tetrahedra; reciprocals of θ -net evaluations corresponding to the “even” and “odd” faces of the tetrahedra, Δ_i ’s on faces, and evaluations of networks shown in Figure 33.

The labels on the network in Figure 33 are given in terms of the ordered 4-simplex $\langle 01234 \rangle$ and will allow the reader to compare the combinatorics of its structure to that of the network in Figure 23 to see that it is indeed just the quantum 15j-symbol in the TL formulation. (As usual \hat{a} means the face obtained by omitting a).

Putting all this together with the normalization factors for the 4-manifold invariant $I(W)$, we find that

$$I(W) = N^{-\frac{\chi(W)}{2}} CY(W),$$

where $\chi(W)$ is the Euler characteristic of W .

Thus, equivalently

$$CY(W) = N^{\frac{\chi(W)}{2}} \kappa^{\sigma(W)}.$$

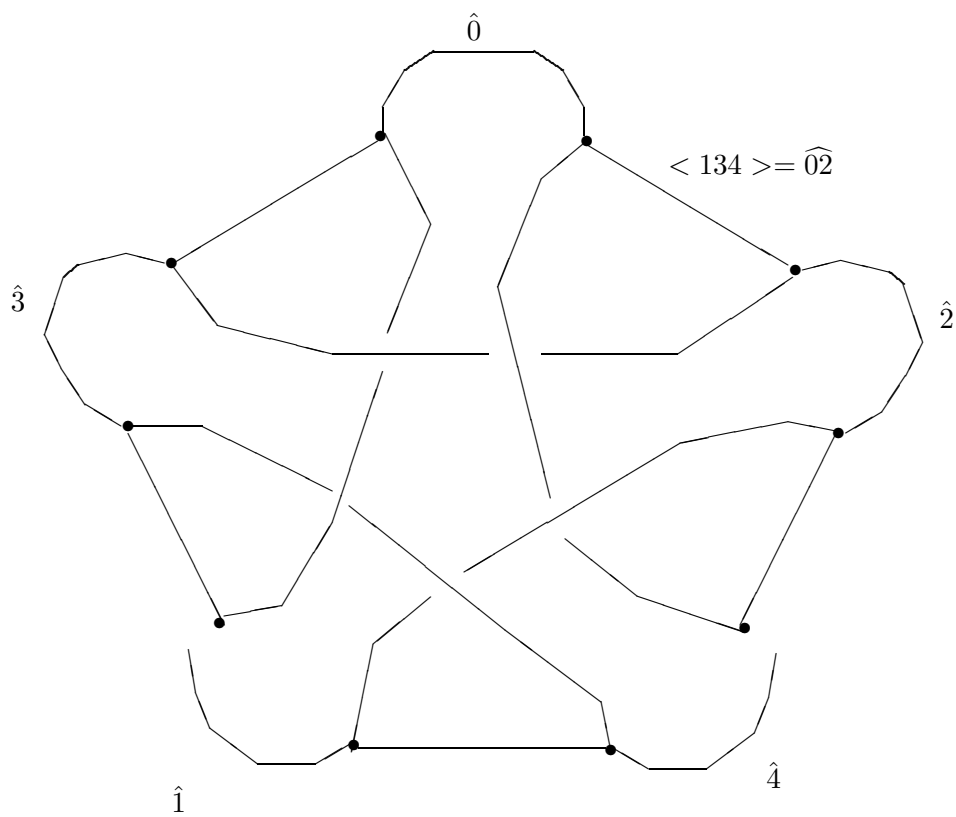


Figure 33: 15j-networks obtained by cutting chainmail

6 The Center and Roberts' Chainmail Method

The keys to Roberts' approach [Ro1] to interpreting the original Crane-Yetter invariant [CY] (cf. also [CKY1]), was the Lickorish Encirclement Lemma (see [L]). The notion of the center of a braided monoidal category introduced in [CKY2] was motivated by the desire to understand this result in more generality.

The analog of Lickorish's lemma at the appropriate level of generality is

Lemma 6.1 ?

$$\sum_{j \in \mathcal{S}} \text{loop } j = N \chi_{Z(\text{cal } \mathcal{C})}(n) \text{Id}_n$$

Figure 34:

where, as usual N is the sum of the squares of the dimensions of the objects in \mathcal{S} and $\chi_{Z(\mathcal{C})}(n) = 1$ if n is an object in the center, and 0 otherwise.

The proof of this Lemma is analogous to that given in [KaLi] or [L]: If n is in the center, we can unbraid it from the loops labelled j , and obtain $N \text{Id}_n$. Otherwise, select an object with which n does not braid trivially, handle-slide this over the $\omega_{\mathcal{C}}$ -labelled loop, and observe that the non-triviality of the braiding implies that the endomorphism of n depicted on the right must be 0, since otherwise it cannot compose with two different maps to give the same result (by simplicity of n).

Observe that in the case where the category has trivial center, this lemma allows us to simply erase (!) components passing through unknotted loops labelled $\omega_{\mathcal{C}}$ just as Lickorish's original formulation did in the case of TL diagrams.

Moreover, in the notation of Section 4, we have

Proposition 6.2 *If \mathcal{C} is a semi-simple tortile category with trivial center, then \mathcal{C} is 3- and 4-conformed, with $N = b = x^2$. Moreover, the generalized Broda invariant $\mathcal{B}_{\mathcal{C}}$ associated to \mathcal{C} satisfies*

$$\mathcal{B}_{\mathcal{C}}(W) = y^{\sigma(W)}$$

and the generalized Crane-Yetter invariant $CY_{\mathcal{C}}$ satisfies

$$CY_{\mathcal{C}}(W) = N^{\frac{\chi(W)}{2}} y^{\sigma(W)}.$$

proof: Once we establish the first statement, the second follows by an analysis essentially identical to that in the previous section. The first statement follows by applying the generalized Lickorish encirclement lemma and triviality of the center to the $\omega_{\mathcal{C}}$ -labelled 0-framed Hopf link, and Lemma 4.1 followed by the generalized Lickorish encirclement lemma and triviality of the center to the $\omega_{\mathcal{C}}$ labelled disjoint union of a +1-framed unknot and a -1-framed unknot. \square

Proposition 6.2 is a generalization of the result of [CKY1] (cf. also [Ro1]) expressing the original Crane-Yetter invariant in terms of the signature and Euler character of the manifold. As noted in

[CKY1] and in the introduction, this result should be regarded as giving a purely combinatorial expression for the signature of a 4-manifold in terms of a triangulation.

At first it may not be clear that this result can be read in this way since y is (for known examples) a root of unity. However, in the case of the TL formulation of $Rep_l(U_q(sl_2))$ with A chosen to be the principal $4r^{th}$ root of unity, by explicit calculations of Roberts [Ro1], we have that

$$y = e^{\frac{-i\pi(3+r^2)}{2r} - \frac{i\pi}{4}}$$

It is not hard to show that if r is chosen to be a multiple of 4 and relatively prime to 3, then y will be a primitive $2r^{th}$ root of unity. Thus choosing such an r greater than the rank of the second homology of the manifold (or for simplicity, greater than the number of 2-simplices in the triangulation used), it is then possible to extract the signature of the manifold from the original Crane-Yetter invariant [CY].

Explicitly, if we let $r = 4n$ ($(n, 3) = 1$) for n sufficiently large, then the signature of W is the unique solution between $-r$ and r to the equation

$$\sigma \frac{-i\pi(3 + 2n)}{8n} = \log(CY(W)N^{\frac{-\chi(W)}{2}}) \pmod{2\pi}$$

where \log is the principal branch of the complex natural logarithm.

A curious (though not particularly important) question is whether there are any artinian semisimple tortile categories which are sufficiently “non-unitary” that y is not a root of unity. If so, the generalized Crane-Yetter invariant for those categories would allow us to compute the signature directly as a logarithm of a state-sum.

An important point for further research is a comparison of this combinatorial expression for the signature with that given by Gelfand and Macpherson [GM].

Another aspect of this formulation of the signature of a 4-manifold bears consideration: The generalized Crane-Yetter invariants are all invariants associated to a TQFT. This fact follows from general principles set down in [Y6]. The transition amplitudes of an generalized Crane-Yetter TQFT, can thus be regarded as giving “relative signatures” for cobordisms. Put another way, Crane-Yetter theory allows us to “factor” 4-manifold signatures along any 3-manifold.

Still, from another point of view, Proposition 6.2 is rather disappointing: the Crane-Yetter and Broda constructions for any semi-simple tortile category with trivial center merely give rise to various encodings of the signature and Euler character of the 4-manifold. The question of whether this construction can give yield other information, say about homotopy type or smooth structure, turns crucially on the properties of the center of the category used.

Two particular points in the construction suggest lines of further research:

The first is the demonstration in the case of a trivial center that $x^2 = N$. In general, the handle-sliding followed by the encirclement lemma shows that

$$x^2 = Nz_+ = Nz_-$$

where z_{\pm} is the value of a ± 1 -framed unknot labelled with $\sum_{i \in Z(\mathcal{C})} \dim(i)i$.

Thus, our category will fail to be 3-conformed if $z_{\pm} = 0$. In this case, the reduction of the generalized Broda invariant to signature will break down.

Similarly there is a property which semi-simple tortile categories could possess which would destroy the reduction of the generalized Crane-Yetter invariant to a generalized Broda invariant: observe that in Roberts chain-mail argument, the encirclement lemma is used to cut an edge labelled with a summand of some $i \otimes i^*$ (for i an object in our set of simple objects). The reduction of the generalized Crane-Yetter invariant to a generalized Broda invariant is thus depends on the category satisfying:

Definition 6.3 A semi-simple tortile category has centrally trivial duality if for every simple object i , the only direct summand of $i \otimes i^*$ to lie in the center is the monoidal identity I .

It is a question for future research whether there are any (interesting) semi-simple tortile categories which fail to have centrally trivial duality or have $z_{\pm} = 0$. If the answer is yes, the corresponding Crane-Yetter and Broda invariants will have to be analysed. We will not conjecture whether they will be more interesting or less interesting than the known examples, though we hope the former and suspect the latter.

7 Extensions to Manifolds with (Co)homology Classes

We conclude by reviewing the extensions of the Crane-Yetter type invariants to 4-manifolds equipped with 2-dimensional (co)homology classes introduced in [Y2] and [Ro2].

In the case of the $U_q(sl_2)$ theory, both constructions are quite easy to state:

Consider a 2-dimensional $Z/2$ -homology class α on W , and choose a representation of it as a sum of distinct 2-simplices of a triangulation.

Roberts' construction gives an invariant of the pair (W, α) by restricting the labels in the Crane-Yetter state-sum to odd labels on the 2-simplices representing it and even labels elsewhere.

Yetter's construction modifies the Crane-Yetter state-sum by multiplying each term by

$$(-1)^{\left\{ \begin{array}{l} \text{number of odd labels on 2-simplices in} \\ \text{the representative 2-cycle} \end{array} \right\}}.$$

Roberts [Ro2] has provided interpretations for his version of this construction, and (private communication) given a "Fourier transform" formula relating the two approaches.

The corresponding constructions for general artinian semisimple tortile categories depend on the notion of a grading of a semisimple monoidal category:

Definition 7.1 If \mathcal{C} is a semisimple monoidal category (over some field), a grading of \mathcal{C} over an abelian group A is a map $||$ from the set (or class) of simple object of \mathcal{C} to A satisfying

1. If $s \cong t$ then $|s| = |t|$.
2. If $s \otimes t \cong \oplus_{i \in I} u_i$ then $|u_i| = |s| + |t|$ for all $i \in I$

It is immediate from general principles that if \mathcal{C} is essentially small, then there exists an abelian group $gr(\mathcal{C})$, equipped with a grading of \mathcal{C} , and univocal among such. We call this group the *universal grading group* of \mathcal{C} . As an example, observe that the universal grading group for $Rep(U_q(sl_n))$ is Z/n , the grade being given by the number of blocks in a Young diagram for the irrep (taken mod n).

Note, that for any abelian group A , there is an abelian group of characters \hat{A} . It is shown in Yetter [Y2] that the group of characters of the universal grading group is isomorphic to the group of functorial monoidal automorphisms (monoidal natural automorphisms of the identity functor). Yetter's invariant of a 4-manifold equipped with a 2-dimensional homology class $[\alpha]$ over $gr(\mathcal{G})$ is then given by

$$Y_{\mathcal{C}}(M, [\alpha]) = \sum_{\lambda \in \Lambda_{\mathcal{C}\mathcal{S}\mathcal{B}}(\mathbf{T})} \ll \lambda, [\alpha] \gg$$

where

$$\ll \lambda, [\alpha] \gg = N^{n_0 - n_1} \prod_{\text{faces } \sigma} tr(\alpha_{\lambda(\sigma)}^{\sigma}) \prod_{\text{tetrahedra } \tau} dim(\lambda(\tau))^{-1} \prod_{\text{4-simplices } \xi} ||\lambda, \xi||$$

α is a representative cycle for $[\alpha]$ subordinate to the triangulation, α^σ is the coefficient of σ (which is a natural transformation), and $\|\lambda, \xi\|$ is the 15j-network appropriate to the 4-simplex ξ and the coloring λ .

Roberts invariant of a 4-manifold equipped with a cohomology class $[\beta]$ in $gr(\mathcal{C})$ is then given by the Crane-Yetter formula, but with the assignments of spins on the faces restricted by $|\lambda(\sigma)| = \beta(\sigma)$, where β is a representative cocycle subordinate to the triangulation.

Proof of the invariance properties of these state-sums, and a discussion of results related to them will be given in the sequel.

8 Appendix on Diagrammatic Notation

The following brief outline of diagrammatic notation for maps in tortile categories is adapted from [Y3]. It is one of the surprising facts, common in quantum topology, that the diagrammatics given here for general tortile categories is, in the case of $Rep(U_q(sl_2))$, in exact coincidence with the diagrammatics already developed by Kauffman [Ka1,Ka2,Ka3] in his application of q -deformed versions of Penrose spin-networks [P] to the construction of statistical mechanical models for knot invariants. The reader will already be familiar with the most refined version of Kauffman’s diagrammatics given in Kauffman/Lins [KaLi], as this is the “TL theory” in the main exposition. We concern ourselves here with the general case:

Diagrammatic notation is best adapted to “arrows-only” descriptions of categories, so we make no distinction between an object and the identity map on the object. Identity maps are denoted by labelled curves descending the page; the tensor product \otimes is denoted by setting side-by-side.

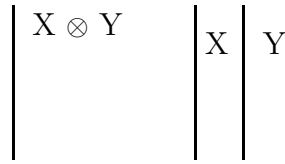


Figure 35: Two ways to denote $X \otimes Y$

In general, maps are denoted by boxes with incoming edges above denoting the source of the map, and outgoing edges below denoting the target of the map, as for example in Figure 36.

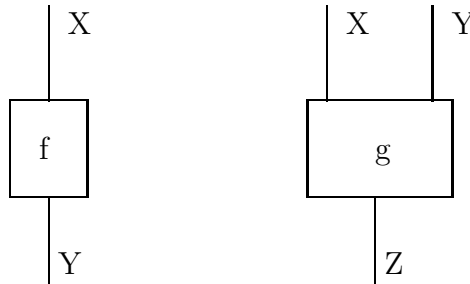


Figure 36: Maps $f : X \rightarrow Y$ and $g : X \otimes Y \rightarrow Z$

Some maps and objects, however, have special notations whose use is justified by the coherence theorems of [S] and [FY2]. In particular, curves labelled with the monoidal identity object I may be omitted.



Figure 37: The braiding and its inverse

The coherence theorems of [S] and [FY2] then insure that manipulating the diagrams by “generalized framed Reidemeister moves” results in a different notation for the same map.

Further suppression of labelling is possible by orienting the curves and considering downward oriented curves as indicating the labelling object, and upward oriented curves as indicating its right



Figure 38: The evaluation and coevaluation maps for a right dual

dual.

Finally, we must note one other subtlety of diagrammatic notation as used here: there are two types of maxima and minima in the diagrammatic notation, those defining the right dual, and those in which the labels X and X^* have been exchanged. Maxima and minima of the second type are the structure maps for X^* as a left dual, and may be expressed in terms of the right duality, the braiding and the “twist” map θ as in Figure 39.

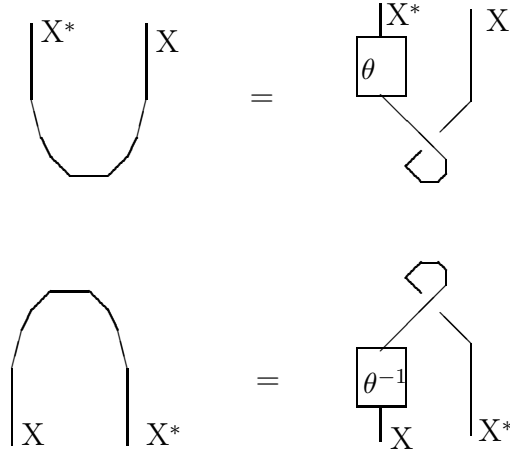


Figure 39: Left duality in terms of right duality, braiding and θ

Since the categories involved are K -linear, we can also denote maps by K -linear combinations of diagrams with the same source and target. Similarly, the “biproduct” condition on the projections and inclusions of direct sum decompositions into simple objects have diagrammatic expressions of the form given in Figure 40, where A, A' are elements of a basis for the relevant hom-space, X denotes an arbitrary object, and S a simple object.

The relation expressed in Figure 40 is used in tandem with Lemma 2.16 in our diagrammatic calculations whenever we remove edges whose labels were summed over (the pictorial version of contracting indices).

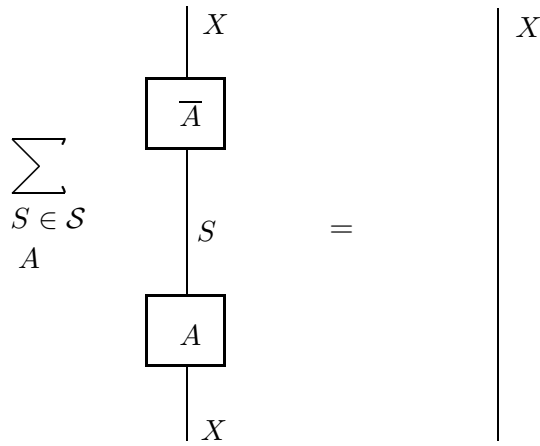
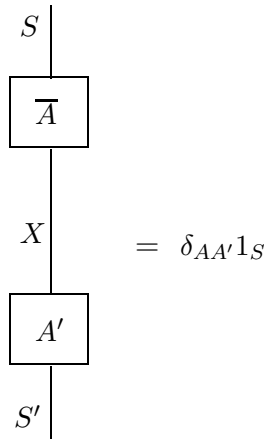


Figure 40:

9 References

- [A] Atiyah, M., “Topological Quantum Field Theories,” *Publ. Math. I.H.E.S.* **68** (1989) 175-186.
- [B] Broda, B., “Surgical Invariants of 4-Manifolds,” preprint (1993).
- [Ca] Casler, B.G., “An Embedding Theorem for Connected 3-Manifolds with Boundary,” *Proc. AMS* **16** (1965) 559-566.
- [CFS] Chung, S., Fukama, M. and Shapere, A., “The Structure of Topological Field Theories in Three Dimensions,” *Int. J. Mod Phys A* (1994) 1305-1360.
- [Cr1] Crane, L., “2D-Physics and 3D-Topology,” *Comm. Math. Phys.* **135** (1991) 615-640.
- [Cr2] Crane, L., “Four Dimensional TQFT; a Triptych,” in *Quantum Topology*, Kauffman, L.H. and Baadhio, R.A. eds., World Scientific Press (1993) 116-119.
- [CF] Crane, L., and Frenkel, I., “Four Dimensional Topological Field Theory, Hopf Categories and the Canonical Basis,” (1994) preprint.
- [CKY1] Crane, L., Kauffman, L.H. and Yetter, D.N., “Evaluating the Crane-Yetter Invariant,” in *Quantum Topology*, Kauffman, L.H. and Baadhio, R.A. eds., World Scientific Press (1993) 131-138.
- [CKY2] Crane, L., Kauffman, L.H. and Yetter, D.N., “On the Failure of the Lickorish Encirclement Lemma for Temperley-Lieb Recoupling Theory at Certain Roots of Unity,” Proceedings of the XXII Conference on Differential Geometric Methods in Theoretical Physics (to appear).
- [CY] Crane, L. and Yetter, D.N., “A Categorical Construction of 4D Topological Quantum Field Theories,” in *Quantum Topology*, Kauffman, L.H. and Baadhio, R.A. eds., World Scientific Press (1993) 120-130.
- [D] Donaldson, S.K., “An Application of Gauge Theory to Four Dimensional Topology,” *J. Diff. Geom.* **18** 269-316.
- [DK] Donaldson, S.K. and Kronheimer, P.B., *The Geometry of Four-Manifolds*, Oxford Mathematical Monographs, Oxford Univ. Press (1990).
- [FY1] Freyd, P. J. and Yetter, D. N., “Braided Compact Closed Categories with Applications to Low-Dimensional Topology,” *Adv. in Math.* **77** (2) (1989) 156-182.
- [FY2] Freyd, P. J. and Yetter, D. N., “Coherence Theorems via Knot Theory,” *JPAA* **78** (1992) 49-76.
- [GM] Gelfand, I.M and Macpherson, R.D., “A Combinatorial Formula for the Pontrjagin Classes,” *Bull. AMS* **26** (2) (1992) 304-308.
- [GK] Gelfand, S. and Kazhdan, D., “Examples of Tensor Categories,” *Invent. Math.* **109** (1992) 595-617.
- [JS1] Joyal, A. and Street, R., “Braided Monoidal Categories,” Macquarie Mathematics Reports No. 860081 (preprint) (1986).
- [Ka1] Kauffman, L.H. “Spin Networks and Knot Polynomials,” *Intl. J. Mod. Phys. A* **5** (1) (1990) 93-115.
- [Ka2] Kauffman, L.H. *Knots and Physics*, World. Sci. Press, 1991.
- [Ka3] Kauffman, L.H. “Map Coloring, q-Deformed Spin Networks and Turaev-Viro Invariants for 3-Manifolds,” in *The Proceedings for the Conference on Quantum Groups – Como, Italy, June 1991*, M. Rasetti, ed., World Sci. Press, *Intl. J. of Mod. Phys. B* **6** (11), (12) (1992) 1765-1794.
- [KaLi] Kauffman, L.H. and Lins, S.L. *Temperley-Lieb Recoupling Theory and Invariants of 3-Manifolds*, Princeton University Press (1994).
- [KeLa] Kelly, G. M. and Laplaza, M. L., “Coherence for Compact Closed Categories,” *JPAA* **19** (1980) 193-213.
- [KM] Kronheimer, P.B. and Mrowka, T.S., “Recurrence Relations and Asymptotics for Four-Manifold Invariants,” *Bull. AMS* **30** (2) (1994) 215-221.
- [Ku] Kuperberg, G., “Involutory Hopf Algebras and 3-Manifold Invariants,” *Int. J. of Math.* **2** (1) (1991) 41-66.

- [JS2] Joyal, A. and Street, R., "The Geometry of Tensor Calculus, I," *Adv. in Math.* **88** (1) (1991) 55-112.
- [KR] Kirillov, A. N. and Reshetikhin, N. Yu., "Representations of the Algebra $U_q(sl(2))$, q -Orthogonal Polynomials and Invariants of Links," in *Infinite Dimensional Lie Algebras and Groups*, V. G. Kac, ed., World Scientific Adv. Series in Math. Phys., vol. 7 (1989).
- [CWM] Mac Lane, S., *Categories for the Working Mathematician*, Springer-Verlag (1971).
- [MS] Moore, G. and Seiberg, N., "Classical and Quantum Conformal Field Theory," *Comm. Math. Phys* **123** (1989) 177-254.
- [P] Penrose, R., "Applications of Negative Dimensional Tensors," in *Combinatorial Mathematics and its Applications* (D. J. A. Welsh, ed) Acad. Press (1971).
- [RP] Ponzano, G. and Regge, T., "The Semi-classical Limit of Racah Coefficients" in *Spectroscopic and Group-Theoretical Methods in Physics* F. Bloch ed., North-Holland (1968).
- [RT] Reshetikhin, N. Yu. and Turaev, V. G., "Ribbon Graphs and Their Invariants Derived from Quantum Groups," *Comm. Math. Phys.* **127** (1) (1990) 1-26.
- [Ro1] Roberts, J. "Skein Theory and Turaev-Viro Invariants" (1993) preprint.
- [Ro2] Roberts, J., "Refined State-Sum Invariants of 3- and 4-Manifolds," (1993) preprint.
- [S] Shum, M.-C., "Tortile Tensor Categories", *JPAA* **93** (1994) 57-110 .
- [T] Turaev, V. G., "Quantum Invariants of 3-Manifolds", *Publication de l'Institutue de Recherche Mathématique Avancée* **509/P-295** (1992).
- [TV] Turaev, V. G. and Viro O. Y., "State Sum Invariants of 3-Manifolds and Quantum 6j-Symbols," *Topology* **31** (4) (1992) 865-902 .
- [W1] Witten, E., "Topological Quantum Field Theory," *Comm. Math. Phys.* **117** (1988) 353-386.
- [W2] Witten, E., "Quantum Field Theory and the Jones Polynomial," *Comm. Math. Phys.* **121** (1989) 351-399.
- [W3] Witten, E., "Supersymmetric Yang-Mills Theory on a 4-Manifold," IASSNS preprint (1994).
- [Y1] Yetter, D. N., "Framed Tangles and a Theorem of Deligne on Braided Deformations of Tannakian Categories," in *Deformation Theory and Quantum Groups with Applications to Mathematical Physics*, M. Gerstenhaber and J. D. Stasheff, eds., AMS Contemp. Math. vol. 134 (1992).
- [Y2] Yetter, D.N., "Homologically Twisted Invariants Related to (2+1)- and (3+1)-Dimensional State-Sum Topological Field Theories," (1993) e-preprint hep-th/9311082.
- [Y3] Yetter, D.N., "State-Sum Invariants of 3-Manifolds Associated to Artinian Semisimple Tortile Categories," *Topology and Its Applications* **58** (1) (1994) 47-80.
- [Y4] Yetter, D. N., "Topological Quantum Field Theories Associated to Finite Groups and Crossed G -Sets," *JKTR* **1** (1) (1992) 1-20.
- [Y5] Yetter, D. N., "TQFT's from Homotopy 2-Types," *JKTR* **2** (1) (1993) 113-123.
- [Y6] Yetter, D.N., "Triangulations and TQFT's" in *Quantum Topology*, Kauffman, L.H. and Baadhio, R.A. eds., World Scientific Press (1993) 354-370.