

Differential cohomology in a cohesive ∞ -topos

Urs Schreiber

21st century

Abstract

We formulate differential cohomology and Chern-Weil theory – the theory of connections on fiber bundles and of gauge fields – abstractly in the context of a certain class of higher toposes that we call *cohesive*. Cocycles in this differential cohomology classify higher principal bundles equipped with *cohesive structure* (topological, smooth, synthetic differential, supergeometric, etc.) and equipped with *connections*, hence *higher gauge fields*. We discuss various models of the axioms and applications to fundamental notions and constructions in quantum field theory and string theory. In particular we show that the cohesive and differential refinement of universal characteristic cocycles constitutes a higher Chern-Weil homomorphism refined from secondary characteristic classes to morphisms of higher moduli stacks of higher gauge fields, and at the same time constitutes extended geometric prequantization – in the sense of extended/multi-tiered quantum field theory – of hierarchies of higher dimensional Chern-Simons-type field theories, their higher Wess-Zumino-Witten-type boundary field theories and all further higher codimension defect field theories. We close with an outlook on the cohomological quantization of such higher boundary prequantum field theories by a kind of cohesive motives.

This document is kept online with accompanying material at
ncatlab.org/schreiber/show/differential+cohomology+in+a+cohesive+topos

General Abstract. We formulate differential cohomology (e.g. [Bun12]) and Chern-Weil theory (e.g. [BoTo82]) – the theory of connections on fiber bundles and of gauge fields – abstractly in the context of a certain class of ∞ -toposes ([L-Topos]) that we call *cohesive*. Cocycles in this differential cohomology classify principal ∞ -bundles equipped with *cohesive structure* (topological, smooth, synthetic differential, supergeometric etc.) and equipped with ∞ -connections, hence *higher gauge fields* (e.g. [Fr00]).

We construct the cohesive ∞ -topos of smooth ∞ -groupoids and ∞ -Lie algebroids and show that in this concrete context the general abstract theory reproduces ordinary differential cohomology (Deligne cohomology/differential characters), ordinary Chern-Weil theory, the traditional notions of smooth principal bundles with connection, abelian and nonabelian gerbes/bundle gerbes with connection, principal 2-bundles with 2-connection, connections on 3-bundles, etc. and generalizes these to higher degree and to base spaces that are orbifolds and generally smooth ∞ -groupoids, such as smooth realizations of classifying spaces/moduli stacks for principal ∞ -bundles and configuration spaces of gauge theories.

We exhibit a general abstract ∞ -Chern-Weil homomorphism and observe that it generalizes the Lagrangian of Chern-Simons theory to ∞ -Chern-Simons theory. For every invariant polynomial on an ∞ -Lie algebroid it sends principal ∞ -connections to *Chern-Simons circle $(n + 1)$ -bundles* (n -gerbes) with connection, whose higher parallel transport is the corresponding higher Chern-Simons Lagrangian. There is a general abstract formulation of the higher holonomy of this parallel transport and this provides the action functional of ∞ -Chern-Simons theory as a morphism on its cohesive configuration ∞ -groupoid. Moreover, to each of these higher Chern-Simons Lagrangian is canonically associated a differentially twisted looping, which we identify with the corresponding *higher Wess-Zumino-Witten Lagrangian*.

We show that, when interpreted in smooth ∞ -groupoids and their variants, these intrinsic constructions reproduce the ordinary Chern-Weil homomorphism, hence ordinary Chern-Simons functionals and ordinary Wess-Zumino-Witten functionals, provide their geometric prequantization in higher codimension (localized down to the point) and generalize this to a fairly extensive list of action functionals of quantum field theories and string theories, some of them new. All of these appear in their refinement from functionals on local differential form data to global functionals defined on the full moduli ∞ -stacks of field configurations/ ∞ -connections, where they represent higher prequantum line bundles. We show that these moduli ∞ -stacks naturally encode fermionic σ -model anomaly cancellation conditions, such as given by higher analogs of Spin-structures and of Spin^c-structures.

We moreover show that *higher symplectic geometry* is naturally subsumed in higher Chern-Weil theory, such that the passage from the unrefined to the refined Chern-Weil homomorphism induced from higher symplectic forms implements *geometric prequantization* of the above higher Chern-Simons and higher Wess-Zumino-Witten functionals. We study the resulting formulation of *local prequantum field theory*, show how it subsumes traditional classical field theory and how it illuminates the boundary and defect structure of higher Chern-Simons-type field theories, their higher Wess-Zumino-Witten type theories, etc.

We close with an outlook on the “motivic quantization” of such local prequantum field theory of higher moduli stacks of fields to genuine local quantum field theory with boundaries and defects, by pull-push in twisted generalized cohomology of higher stacks and conclude that cohesive ∞ -toposes provide a “synthetic” axiomatization of local quantum gauge field theories obtained from geometric Lagrangian data [Sc13d].

We think of these results as providing a further ingredient of the recent identification of the mathematical foundations of quantum field and perturbative string theory [SaSc11a]: while the cobordism theorem [L-TFT] identifies topological quantum field theories and their boundary and defect theories with a universal construction in higher category theory (representations of free symmetric monoidal (∞, n) -categories with full duals), our results indicate that the geometric structures that these arise from under geometric motivic quantization originate in a universal construction in higher topos theory: *cohesion*.

Acknowledgements. The program discussed here was initiated around the writing of [SSS09c], following an unpublished precursor set of notes [SSSS08], presented at [Sc09], which was motivated in parts by the desire to put the explicit constructions of [SSW05, ScWa07, ScWa08, ScWa08, BCSS07, RoSc08] on a broader conceptual basis. The present text has grown out of and subsumes these and the series of publications [Sc09, ScSk10, FSS10, FSS12a, FSS12b, FSS12c, NSS12a, NSS12b, ScSh12, FSS13a, FRS13a, FRS13b, FSS13b, Nui13]. Notes from a lecture series introducing some of the central ideas with emphasis on applications to string theory are available as [Sc12]. (The basic idea of considering differential cohomology in the ∞ -topos over smooth manifolds has then also been voiced in [Ho11], together with the statement that this is the context in which the seminal article [HoSi05] on differential cohomology was eventually meant to be considered, then done in [BNV13], see 4.1 below.) A survey of the general project of “Synthetic quantum field theory” in cohesive ∞ -toposes is in [Sc13d]. The following text aims to provide a comprehensive theory and account of these developments. In as far as it uses paragraphs taken from the above joint publications, these paragraphs have been primarily authored by the present author.

I cordially thank all my coauthors for their input and work and for discussion. Especially I thank Domenico Fiorenza for joining in on working out details of cohesive higher geometry and for improving on my expositions; and Hisham Sati for providing a steady stream of crucial examples and motivations from string theory and M-theory. I am grateful to Richard Williamson for an extra derived left adjoint, to David Carchedi for an extra derived right adjoint and to a talk by Peter Johnstone for making me recognize their 1-categorical shadow in Lawvere’s writing, all at an early stage of this work. I am indebted to Mike Shulman for plenty of discussion of and input on higher topos theory and homotopy type theory in general. I had and have plenty of inspiring conversations with David Corfield on conceptual questions, a good bit of which has influenced the developments presented here. Then I thank Igor Khavkine for discussion of covariant field theory. I thank Uli Bunke, Thomas Nikolaus, and Michael Völkl for discussion of stable cohesion and for finding the “differential cohomology diagram” from just the axioms of stable cohesion. I also thank the participants of the *third String Geometry Network meeting* for discussion of supergeometric cohesion and supergeometric higher WZW models; special thanks to Bas Janssen for being really careful with super Lie algebra cohomology. I am grateful to Charles Rezk for telling me about cohesion in global equivariant homotopy theory and for providing pointers related to stable cohesion. Last but not least I am thankful to Ieke Moerdijk. David Corfield and Geoffrey Cruttwell kindly commented on the text at some stage or through some stages of its development. Further typos were spotted by Igor Khavkine, Fosco Loregian, Zhen Lin Low, David Roberts.

Main contents

1	Introduction	16
1.1	Motivation	16
1.2	The geometry of physics	45
2	Homotopy type theory	214
2.1	∞ -Categories	214
2.2	∞ -Toposes	221
2.3	Universal constructions	233
3	Cohesive and differential homotopy type theory	243
3.1	Introduction and survey	243
3.2	Local ∞ -toposes	246
3.3	Locally ∞ -connected ∞ -toposes	246
3.4	Cohesive ∞ -toposes	249
3.5	Differential cohesive ∞ -toposes	261
3.6	Structures in an ∞ -topos	267
3.7	Structures in a local ∞ -topos	350
3.8	Structures in a locally ∞ -connected ∞ -topos	353
3.9	Structures in a cohesive ∞ -topos	364
3.10	Structures in a differentially cohesive ∞ -topos	427
4	Models	441
4.1	Parameterized cohesive homotopy theory	442
4.2	Geometrically discrete ∞ -groupoids	450
4.3	Euclidean-topological ∞ -groupoids	456
4.4	Smooth ∞ -groupoids	476
4.5	Synthetic differential ∞ -groupoids	550
4.6	Supergeometric ∞ -groupoids	571
5	Applications – Local prequantum higher gauge field theory	577
5.1	Higher Spin-structures	577
5.2	Higher prequantum fields	602
5.3	Higher symplectic geometry	670
5.4	Higher prequantum geometry	679
5.5	Higher Chern-Simons field theory	693
5.6	Higher Wess-Zumino-Witten field theory	729
5.7	Local boundary and defect prequantum field theory	747
6	Outlook: Motivic quantization of local prequantum field theory	763

In 1 we motivate our discussion, give an informal introduction to the main concepts involved and survey various of our constructions and applications in a more concrete, more traditional and more expository way than in the sections to follow. This may be all that some readers ever want to see, while other readers may want to skip it entirely.

In 2 we review relevant aspects of *homotopy type theory*, the theory of ∞ -categories and ∞ -toposes, in terms of which all of the following is formulated. This serves to introduce context and notation and to provide a list of technical lemmas which we need in the following, some of which are not, or not as explicitly, stated in existing literature.

In 3 we introduce *cohesive homotopy type theory*, a general abstract theory of differential geometry, differential cohomology and Chern-Weil theory in terms of universal constructions in ∞ -topos theory. This is in the spirit of Lawvere’s proposals [Law07] for axiomatic characterizations of those *gros toposes* that serve as contexts for abstract *geometry* in general and *differential geometry* in particular: *cohesive toposes*. We claim that the decisive role of these axioms is realized when generalizing from topos theory to ∞ -topos theory and we discuss a fairly long list of geometric structures that is induced by the axioms in this case. Notably we show that every ∞ -topos satisfying the immediate analog of Lawvere’s axioms – every *cohesive ∞ -topos* – comes with a good intrinsic notion of differential cohomology and Chern-Weil theory.

Then we add a further simple set of axioms to obtain a theory of what we call *differential cohesion*, a refinement of cohesion that axiomatizes the explicit (“synthetic”) presence of infinitesimal objects. This is closely related to Lawvere’s *other* proposal for axiomatizing toposes for differential geometry, called *synthetic differential geometry* [Law97], but here formulated entirely in terms of higher *closure modalities* as for cohesion itself. We find that these axioms also capture the modern synthetic-differential theory of *D-geometry* [L-DGeo]. In particular a differential cohesive ∞ -topos has an intrinsic notion of (formally) *étale maps*, which makes it an axiomatic geometry in the sense of [L-Geo] and equips it with intrinsic *manifold* theory.

In 4 we discuss models of the axioms, hence ∞ -toposes of ∞ -groupoids which are equipped with a geometric structure (topology, smooth structure, supergeometric structure, etc.) in a way that all the abstract differential geometry theory developed in the previous chapter can be realized. The main model of interest for our applications is the cohesive ∞ -topos $\text{Smooth}\infty\text{Grpd}$ as well as its infinitesimal thickening $\text{SynthDiff}\infty\text{Grpd}$, which we construct. Then we go step-by-step through the list of general abstract structures in cohesive ∞ -toposes and unwind what these amount to in this model. We demonstrate that these subsume traditional definitions and constructions and generalize them to higher differential geometry and differential cohomology.

In 5 we discuss applications of the general theory in the context of smooth ∞ -groupoids and their synthetic-differential and super-geometric refinements to aspects of higher gauge prequantum field theory. We present a fairly long list of higher Spin- and Spin^c-structures, of classes of local action functionals on higher moduli stacks of fields of higher Chern-Simons type and functionals of higher Wess-Zumino-Witten type, that are all naturally induced by higher Chern-Weil theory. We exhibit a higher analog of geometric prequantization that applies to these systems and show that it captures a wealth of structures, such as notably the local boundary and higher codimension defect structure. Apart from the new constructions and results, this shows that large parts of local prequantum gauge field theory are canonically and fundamentally induced by abstract cohesion.

In 6 we close with an outlook on how the quantization of the local prequantum gauge field theory to genuine local quantum field theory proceeds via higher linear algebra in cohesive ∞ -toposes, namely via duality of cohesive stable homotopy types.

Contents

1	Introduction	16
1.1	Motivation	16
1.1.1	The gauge principle and geometric homotopy theory	18
1.1.2	Global effects and anomaly cancellation	20
1.1.3	Hierarchies of natural action functionals	26
1.1.4	Philosophical motivation	41
1.2	The geometry of physics	45
1.2.1	Coordinate systems	46
1.2.1.1	The continuum real (world-)line	46
1.2.1.2	Cartesian spaces and smooth functions	47
1.2.1.3	The fundamental theorems about smooth functions	48
1.2.2	Smooth 0-types	48
1.2.2.1	Plots of smooth spaces and their gluing	49
1.2.2.2	Homomorphisms of smooth spaces	51
1.2.2.3	Products and fiber products of smooth spaces	52
1.2.2.4	Smooth mapping spaces and smooth moduli spaces	53
1.2.2.5	The smooth moduli space of smooth functions	54
1.2.2.6	Outlook	54
1.2.3	Differential forms	55
1.2.3.1	Differential forms on abstract coordinate systems	55
1.2.3.2	Differential forms on smooth spaces	57
1.2.3.3	Concrete smooth spaces	59
1.2.3.4	Smooth moduli spaces of differential forms on a smooth space	59
1.2.4	Smooth homotopy types	60
1.2.4.1	Toposes	61
1.2.4.1.1	Sheaves	61
1.2.4.1.2	Concrete and non-concrete sheaves	63
1.2.4.2	∞ -Toposes	63
1.2.4.2.1	∞ -Groupoids	63
1.2.4.2.2	∞ -Sheaves / ∞ -Stacks	67
1.2.4.2.3	Structured ∞ -Groups	68
1.2.4.3	Cohomology	69
1.2.4.4	Homotopy	72
1.2.5	Principal bundles	74
1.2.5.1	Principal 1-bundles	74
1.2.5.2	Principal 2-bundles and twisted 1-bundles	78
1.2.5.3	Principal 3-bundles and twisted 2-bundles	84
1.2.5.4	A model for principal ∞ -bundles	90
1.2.5.5	Higher fiber bundles	91
1.2.5.5.1	Ordinary principal bundles	91
1.2.5.5.2	Principal ∞ -bundles	92
1.2.5.5.3	Associated and twisted ∞ -bundles	93
1.2.6	Principal connections	95
1.2.6.1	Parallel n -transport for low n	95
1.2.6.1.1	Connections on a principal bundle	96
1.2.6.1.2	Connections on a principal 2-bundle	99
1.2.6.1.3	Curvature characteristics of 1-bundles	101
1.2.6.1.4	Circle n -bundles with connection	105
1.2.6.1.5	Holonomy and canonical action functionals	109
1.2.6.2	Differential cohomology	110

1.2.6.3	Higher geometric prequantization	112
1.2.7	Characteristic classes	112
1.2.8	Lie algebras	119
1.2.8.1	L_∞ -algebroids	119
1.2.8.2	Lie integration	121
1.2.8.3	Characteristic cocycles from Lie integration	122
1.2.8.4	L_∞ -algebra valued connections	123
1.2.8.5	Curvature characteristics and Chern-Simons forms	124
1.2.8.6	∞ -Connections from Lie integration	127
1.2.8.6.1	Curvature characteristics	129
1.2.8.6.2	1-Morphisms: integration of infinitesimal gauge transformations	129
1.2.8.7	Examples of ∞ -connections	131
1.2.8.7.1	Connections on ordinary principal bundles	131
1.2.8.7.2	string-2 -connections	131
1.2.9	The Chern-Weil homomorphism	134
1.2.9.1	Motivating examples	134
1.2.9.2	The ∞ -Chern-Weil homomorphism	137
1.2.9.2.1	∞ -Chern-Simons functionals	137
1.2.9.2.2	Secondary characteristic classes	138
1.2.10	Hamilton-Jacobi-Lagrange mechanics via prequantized Lagrangian correspondences	140
1.2.10.1	Phase spaces and symplectic manifolds	141
1.2.10.2	Coordinate systems and the topos of smooth spaces	143
1.2.10.3	Canonical transformations and Symplectomorphisms	145
1.2.10.4	Trajectories and Lagrangian correspondences	145
1.2.10.5	Observables, symmetries and the Poisson bracket Lie algebra	149
1.2.10.6	Hamiltonian (time evolution) trajectories and Hamiltonian correspondences	152
1.2.10.7	Noether symmetries and equivariant structure	154
1.2.10.8	Gauge theory, smooth groupoids and higher toposes	156
1.2.10.9	The kinetic action, pre-quantization and differential cohomology	158
1.2.10.10	The classical action, the Legendre transform and Hamiltonian flows	161
1.2.10.11	The classical action functional pre-quantizes Lagrangian correspondences	163
1.2.10.12	Quantization, the Heisenberg group, and slice automorphism groups	164
1.2.10.13	Integrable systems, moment maps and maps into the Poisson bracket	167
1.2.10.14	Classical anomalies and projective symplectic reduction	168
1.2.11	Hamilton-De Donder-Weyl field theory via Higher correspondences	168
1.2.11.1	Local field theory Lagrangians and n -plectic smooth spaces	169
1.2.11.2	Local observables, conserved currents and higher Poisson brackets	173
1.2.11.3	Field equations of motion and Higher Poisson-Maurer-Cartan elements	176
1.2.11.4	Source terms, off-shell Poisson bracket and Poisson holography	179
1.2.12	Higher pre-quantum gauge fields	182
1.2.12.1	Cocycles: generalized, parameterized, twisted	184
1.2.12.2	Fields of gravity: special and generalized geometry	187
1.2.12.3	Gauge fields: higher, twisted, non-abelian	192
1.2.12.4	Gauge invariance, equivariance and general covariance	195
1.2.13	Variational calculus on higher moduli stacks of fields	196
1.2.14	Higher geometric prequantum theory	199
1.2.15	Examples of higher prequantum field theories	201
1.2.15.1	Extended 3d Chern-Simons theory	202
1.2.15.1.1	$k = 0$: the universal Chern-Simons 3-connection $\hat{\mathbf{c}}$	202
1.2.15.1.2	$k = 1$: the Wess-Zumino-Witten gerbe	203
1.2.15.1.3	$k = 2$: Symplectic structure on the moduli of flat connections	205

1.2.15.1.4	$k = 3$: the Chern-Simons action functional	206
1.2.15.1.5	The Chern-Simons action functional with Wilson loops	207
1.2.15.2	The anomaly-free gauge coupling of the open string	209
2	Homotopy type theory	214
2.1	∞ -Categories	214
2.1.1	Dependent homotopy types and Locally cartesian closed ∞ -categories	214
2.1.2	Presentation by simplicial sets	216
2.1.3	Presentation by simplicially enriched categories	217
2.2	∞ -Toposes	221
2.2.1	Abstract ∞ -category theoretic characterization	221
2.2.2	Syntax of homotopy type theory with type universes	223
2.2.3	Presentation by simplicial (pre-)sheaves	224
2.2.4	Presentation by simplicial objects in the site	226
2.2.5	∞ -Sheaves and descent	228
2.2.6	∞ -Sheaves with values in chain complexes	231
2.3	Universal constructions	233
2.3.1	General abstract	233
2.3.1.1	∞ -Colimits in ∞ Grpd	233
2.3.1.2	∞ -Pullbacks	233
2.3.1.3	Effective epimorphisms	233
2.3.2	Presentations	234
2.3.2.1	∞ -Pullbacks	234
2.3.2.2	Finite ∞ -limits of ∞ -sheaves	235
2.3.2.3	∞ -Colimits	236
2.3.2.4	∞ -Colimits over simplicial diagrams	238
2.3.2.5	Effective epimorphisms, atlases and décalage	241
3	Cohesive and differential homotopy type theory	243
3.1	Introduction and survey	243
3.2	Local ∞ -toposes	246
3.3	Locally ∞ -connected ∞ -toposes	246
3.3.1	General abstract	246
3.3.2	Presentations	248
3.4	Cohesive ∞ -toposes	249
3.4.1	General abstract	250
3.4.1.1	External formulation	250
3.4.1.2	Internal formulation	252
3.4.2	Presentation	255
3.4.2.1	Presentation over ∞ -cohesive sites	255
3.4.2.2	Fibrancy over ∞ -cohesive sites	258
3.5	Differential cohesive ∞ -toposes	261
3.5.1	General abstract	262
3.5.2	Presentations	264
3.6	Structures in an ∞ -topos	267
3.6.1	Bundles	267
3.6.1.1	General abstract	268
3.6.1.2	Presentations	273
3.6.2	Truncated objects and Postnikov towers	274
3.6.2.1	General abstract	274
3.6.2.2	Presentations	275
3.6.3	Epi-/mono-morphisms, images and relative Postnikov systems	276

3.6.3.1	General abstract	276
3.6.3.2	Presentations	280
3.6.4	Compact objects	282
3.6.5	Homotopy	287
3.6.5.1	General abstract	287
3.6.5.2	Presentations	287
3.6.6	Connected objects	287
3.6.6.1	General abstract	287
3.6.6.2	Presentations	289
3.6.7	Groupoids	291
3.6.7.1	General abstract	292
3.6.7.1.1	Atlases	292
3.6.7.1.2	Group of Bisections	294
3.6.7.1.3	Atiyah groupoids	295
3.6.8	Groups	299
3.6.8.1	General abstract	300
3.6.8.2	Presentations	302
3.6.9	Cohomology	304
3.6.9.1	General abstract	304
3.6.9.2	Presentations	307
3.6.9.2.1	Cocycle ∞ -groupoids and cohomology classes	307
3.6.9.2.2	Fiber sequences	309
3.6.10	Principal bundles	309
3.6.10.1	Introduction and survey	309
3.6.10.2	Definition and classification	311
3.6.10.3	Universal principal ∞ -bundles and the Borel construction	317
3.6.10.4	Presentation in locally fibrant simplicial sheaves	319
3.6.11	Associated fiber bundles	326
3.6.11.1	General abstract	326
3.6.11.2	Presentation in locally fibrant simplicial sheaves	334
3.6.12	Sections and twisted cohomology	334
3.6.12.1	General abstract	335
3.6.12.2	Presentations	338
3.6.13	Representations and group cohomology	338
3.6.13.1	General abstract.	339
3.6.13.2	Presentations.	341
3.6.14	Extensions and twisted bundles	341
3.6.15	Gerbes	345
3.6.16	Relative cohomology	349
3.7	Structures in a local ∞ -topos	350
3.7.1	Codiscrete objects	350
3.7.2	Concrete objects	351
3.7.2.1	General abstract	351
3.7.2.2	Presentations	352
3.8	Structures in a locally ∞ -connected ∞ -topos	353
3.8.1	Geometric homotopy / Étale homotopy	353
3.8.2	Concordance	354
3.8.3	Paths and geometric Postnikov towers	355
3.8.4	Universal coverings and geometric Whitehead towers	356
3.8.5	Flat connections and local systems	357
3.8.6	Galois theory	358

3.9	Structures in a cohesive ∞ -topos	364
3.9.1	\mathbb{A}^1 -Homotopy / The Continuum	365
3.9.2	Manifolds (unseparated)	366
3.9.3	de Rham cohomology	367
3.9.4	Exponentiated ∞ -Lie algebras	371
3.9.5	Maurer-Cartan forms and curvature characteristic forms	372
3.9.6	Differential cohomology	373
3.9.6.1	General	373
3.9.6.2	Global curvature forms	374
3.9.6.3	Ordinary differential cohomology	376
3.9.6.4	Differential moduli	380
3.9.6.5	Flat Differential moduli	382
3.9.7	Chern-Weil theory	383
3.9.8	Twisted differential structures	384
3.9.9	Higher holonomy	385
3.9.10	Transgression	386
3.9.11	Chern-Simons functionals	386
3.9.12	Wess-Zumino-Witten functionals	387
3.9.13	Prequantum geometry	393
3.9.13.1	Introduction and survey	394
3.9.13.2	Prequantization	398
3.9.13.3	Symplectomorphisms	398
3.9.13.4	Contactomorphisms	399
3.9.13.5	Quantomorphism group and Heisenberg group	399
3.9.13.6	Courant groupoids	402
3.9.13.7	Poisson and Heisenberg Lie algebra	404
3.9.13.8	Prequantum states	404
3.9.13.9	Prequantum operators	405
3.9.14	Local prequantum field theory	406
3.9.14.1	Introduction	407
3.9.14.1.1	Action functionals and correspondences	407
3.9.14.1.2	Local Lagrangians and higher differential cocycles	411
3.9.14.1.3	Boundary field theory and twisted relative cohomology	412
3.9.14.2	The local bulk fields	413
3.9.14.3	Local action functionals for the bulk field theory	418
3.9.14.4	Boundary field theory	421
3.9.14.5	Corner field theory	425
3.9.14.6	Defect field theory	426
3.10	Structures in a differentially cohesive ∞ -topos	427
3.10.1	Infinitesimal path ∞ -groupoid and de Rham spaces	427
3.10.2	Crystalline cohomology, flat infinitesimal connections and local systems	428
3.10.3	Jet bundles	429
3.10.4	Infinitesimal Galois theory / Formally étale morphisms	429
3.10.5	Formally étale groupoids	435
3.10.6	Manifolds (separated)	435
3.10.7	Structure sheaves	436
3.10.8	Critical loci, variational calculus and BV-BRST complexes	438
3.10.9	Formal groupoids	440

4	Models	441
4.1	Parameterized cohesive homotopy theory	442
4.1.1	Bundles of cohesive homotopy types	442
4.1.2	Bundles of cohesive stable homotopy types	444
4.1.2.1	Cohomology	447
4.1.2.2	DifferentialCohomology	448
4.2	Geometrically discrete ∞ -groupoids	450
4.2.1	Geometric homotopy	450
4.2.2	Groups	451
4.2.3	Cohomology	451
4.2.3.1	Group cohomology	451
4.2.4	Principal bundles	452
4.2.5	Twisted cohomology	454
4.2.6	Representations and associated bundles	455
4.3	Euclidean-topological ∞ -groupoids	456
4.3.1	Stalks	461
4.3.2	Groups	463
4.3.3	Representations	465
4.3.4	Geometric homotopy	466
4.3.4.1	Geometric realization of topological ∞ -groupoids	466
4.3.4.2	Examples	468
4.3.5	\mathbb{R}^1 -homotopy / The standard continuum	469
4.3.6	Manifolds	469
4.3.7	Paths and geometric Postnikov towers	470
4.3.8	Cohomology	470
4.3.8.1	Čech cohomology	470
4.3.8.2	Nonabelian cohomology with constant coefficients	471
4.3.8.3	Equivariant cohomology	471
4.3.9	Principal bundles	472
4.3.10	Gerbes	474
4.3.11	Universal coverings and geometric Whitehead towers	475
4.4	Smooth ∞ -groupoids	476
4.4.1	Concrete objects	479
4.4.2	Groups	480
4.4.3	Groupoids	482
4.4.3.1	Group of bisections	483
4.4.3.2	Atiyah groupoids	483
4.4.4	Geometric homotopy	484
4.4.4.1	Geometric realization of simplicial smooth spaces	484
4.4.4.2	Co-Tensoring of smooth ∞ -Stacks over homotopy types of manifolds	486
4.4.5	Paths and geometric Postnikov towers	487
4.4.6	Cohomology	487
4.4.6.1	Cohomology with constant coefficients	488
4.4.6.2	Refined Lie group cohomology	488
4.4.7	Principal bundles	489
4.4.8	Twisted cohomology and twisted bundles	491
4.4.9	∞ -Group representations	491
4.4.10	Associated bundles	492
4.4.11	Manifolds	493
4.4.12	Flat connections and local systems	493
4.4.13	de Rham cohomology	495

4.4.14	Exponentiated ∞ -Lie algebras	498
4.4.14.1	Examples	500
4.4.14.2	Flat coefficient objects for exponentiated L_∞ -algebras.	502
4.4.14.3	de Rham coefficients	505
4.4.15	Maurer-Cartan forms and curvature characteristic forms	506
4.4.15.1	Canonical form on an ordinary Lie group	507
4.4.15.2	Canonical form on the circle n -group	508
4.4.15.3	Canonical form on a simplicial Lie group	512
4.4.16	Differential cohomology	514
4.4.16.1	The smooth n -groupoid of circle-principal n -connections	515
4.4.16.2	The universal moduli n -stack of circle-principal n -connections	517
4.4.16.3	The smooth moduli of connections over a given base	518
4.4.16.3.1	Moduli of smooth principal 1-connections	520
4.4.16.3.2	Moduli of smooth principal 2-connections	522
4.4.16.4	Equivariant circle n -bundles with connection	523
4.4.17	∞ -Chern-Weil homomorphism	524
4.4.18	Higher holonomy and parallel transport – Fiber integration in differential cohomology	531
4.4.19	Chern-Simons functionals	536
4.4.20	Prequantum geometry	536
4.4.20.1	n -Plectic manifolds and their Hamiltonian vector fields	537
4.4.20.2	The L_∞ -algebra of local observables	538
4.4.20.3	The Kostant-Souriau L_∞ -cocycle	539
4.4.20.4	The Kostant-Souriau-Heisenberg L_∞ -extension	540
4.4.20.5	Ordinary symplectic geometry and its prequantization	540
4.4.20.6	2-Plectic geometry and its prequantization	545
4.5	Synthetic differential ∞ -groupoids	550
4.5.1	∞ -Lie algebroids	552
4.5.1.1	L_∞ -Algebroids and smooth commutative dg-algebras	552
4.5.1.2	Infinitesimal smooth groupoids	554
4.5.1.3	Lie 1-algebroids as infinitesimal simplicial presheaves	556
4.5.1.4	∞ -Lie differentiation	559
4.5.2	Manifolds	560
4.5.3	Cohomology	561
4.5.3.1	Cohomology localization	561
4.5.3.2	Lie group cohomology	562
4.5.3.3	∞ -Lie algebroid cohomology	564
4.5.4	Extensions of L_∞ -algebroids	565
4.5.5	Infinitesimal path groupoid and de Rham spaces	566
4.5.6	Formally smooth/étale/unramified morphisms	567
4.5.7	Formally étale groupoids	569
4.5.8	Chern-Weil theory	569
4.5.8.1	∞ -Cartan connections	569
4.6	Supergeometric ∞ -groupoids	571
4.6.1	Survey	571
4.6.2	The ∞ -topos of supergeometric ∞ -stacks	572
4.6.3	Associated bundles	574
4.6.4	Exponentiated ∞ -Lie algebras	575

5	Applications – Local prequantum higher gauge field theory	577
5.1	Higher Spin-structures	577
5.1.1	Overview: the smooth and differential Whitehead tower of BO	578
5.1.2	Orientation structure	581
5.1.3	Spin structure	582
5.1.4	Smooth string structure and the String-2-group	583
5.1.5	Smooth fivebrane structure and the Fivebrane-6-group	595
5.1.6	Higher Spin^c -structures	597
5.1.7	Spin^c as a homotopy fiber product in $\text{Smooth}\infty\text{Grpd}$	597
5.1.8	Smooth String^{c2}	599
5.2	Higher prequantum fields	602
5.2.1	Introduction and Overview	602
5.2.1.1	Example: Orthogonal structures.	603
5.2.1.2	Example: (Exceptional) generalized geometry.	603
5.2.1.3	Example: Spin structures.	604
5.2.1.4	Example: Heterotic fields.	604
5.2.1.5	Example: Dual heterotic fields.	604
5.2.2	Sections of vector bundles – twisted 0-bundles	610
5.2.3	Sections of 2-bundles – twisted vector bundles and twisted K-classes	612
5.2.4	Reduction of structure groups	616
5.2.4.1	Orthogonal/Riemannian structure	619
5.2.4.2	Type II NS-NS generalized geometry	621
5.2.4.3	U-duality geometry / exceptional generalized geometry	622
5.2.5	Orientifolds and higher orientifolds	623
5.2.6	Twisted topological structures in quantum anomaly cancellation	626
5.2.6.1	The type II superstring and twisted Spin^c -structures	627
5.2.6.2	The heterotic/type I superstring and twisted String-structures	629
5.2.6.3	The M2-brane and twisted String^{2a} -structures	631
5.2.6.4	The NS-5-brane and twisted Fivebrane-structures	633
5.2.6.5	The M5-brane and twisted Fivebrane $^{2a\cup 2a}$ -structures	633
5.2.7	Twisted differential structures in quantum anomaly cancellation	634
5.2.7.1	Twisted differential \mathfrak{c}_1 -structures	634
5.2.7.2	Twisted differential spin^c -structures	636
5.2.7.3	Twisted differential string structures	639
5.2.7.3.1	L_∞ -Čech cocycles for differential string structures	642
5.2.7.3.2	The Green-Schwarz mechanism in heterotic supergravity	649
5.2.8	Classical supergravity	651
5.2.8.1	First-order/gauge theory formulation of gravity	651
5.2.8.2	L_∞ -extensions of the super Poincaré Lie algebra	653
5.2.8.3	The super Poincaré Lie algebra	653
5.2.8.3.1	M2-brane Lie 3-algebra and the M-theory Lie algebra	653
5.2.8.3.2	Exceptional cocycles and the brane scan	654
5.2.8.4	Supergravity fields are super L_∞ -connections	655
5.2.8.4.1	The graviton and the gravitino	655
5.2.8.4.2	The 11d supergravity C_3 -field	655
5.2.8.4.3	The magnetic dual 11d supergravity C_6 -field	655
5.2.9	The supergravity C -field	656
5.2.9.1	Higher abelian Chern-Simons theories with background charge	656
5.2.9.2	Differential integral Wu structures	658
5.2.9.3	Twisted differential $\text{String}(E_8)$ -structures	661
5.2.9.4	The moduli 3-stack of the C -field	662

	5.2.9.5	The homotopy type of the moduli stack	665	
	5.2.9.6	Boundary moduli of the C-field	666	
	5.2.9.7	Hořava-Witten boundaries are membrane orientifolds	668	
	5.2.10	Differential T-duality	669	
5.3	Higher	symplectic geometry	670	
	5.3.1	Symplectic dg-geometry	671	
	5.3.2	Symplectic L_∞ -algebroids	674	
	5.3.3	Symplectic smooth ∞ -groupoids	676	
5.4	Higher	prequantum geometry	679	
	5.4.1	Higher prequantum 2d WZW model and the smooth string 2-group	679	
	5.4.2	Higher prequantum n d Chern-Simons-type theories and L_∞ -algebra cohomology	682	
	5.4.3	Higher prequantum 2d Poisson-Chern-Simons theory and quantum mechanics	686	
	5.4.4	Higher prequantum 6d WZW-type models and the smooth fivebrane-6-group	689	
5.5	Higher	Chern-Simons field theory	693	
	5.5.1	∞ -Chern-Simons field theory	694	
		5.5.1.1 Fiber integration and extended Chern-Simons functionals	694	
		5.5.1.2 Construction from L_∞ -cocycles	698	
	5.5.2	Higher cup-product Chern-Simons theories	700	
		5.5.2.1 General construction	700	
	5.5.3	Higher differential Dixmier-Douady class and higher dimensional $U(1)$ -holonomy	702	
	5.5.4	1d Chern-Simons functionals	703	
	5.5.5	3d Chern-Simons functionals	703	
		5.5.5.1 Ordinary Chern-Simons theory for simply connected simple gauge group	704	
			5.5.5.1.1 Extended Lagrangian and action functional	704
			5.5.5.1.2 The extended phase spaces	704
		5.5.5.2 Ordinary 3d $U(1)$ -Chern-Simons theory and generalized B_n -geometry	705	
		5.5.5.3 Ordinary Dijkgraaf-Witten theory	706	
	5.5.6	4d Chern-Simons functionals	707	
		5.5.6.1 BF theory and topological Yang-Mills theory	707	
		5.5.6.2 4d Yetter model	708	
	5.5.7	Abelian gauge coupling of branes	708	
	5.5.8	Higher abelian Chern-Simons functionals	709	
		5.5.8.1 $(4k + 3)$ d $U(1)$ -Chern-Simons functionals	709	
		5.5.8.2 Higher electric coupling and higher gauge anomalies	710	
	5.5.9	7d Chern-Simons functionals	711	
		5.5.9.1 The cup product of a 3d CS theory with itself	711	
		5.5.9.2 7d CS theory on string 2-connection fields	712	
		5.5.9.3 7d CS theory in 11d supergravity on AdS_7	713	
			5.5.9.3.1 Motivation from AdS_7/CFT_6 -holography	713
			5.5.9.3.2 Definition and properties	715
	5.5.10	Action of closed string field theory type	718	
	5.5.11	Non-perturbative AKSZ theory	719	
		5.5.11.1 AKSZ σ -Models	720	
		5.5.11.2 The AKSZ action as an ∞ -Chern-Simons functional	723	
		5.5.11.3 Ordinary Chern-Simons theory	725	
		5.5.11.4 Poisson σ -model	725	
		5.5.11.5 Courant σ -model	726	
		5.5.11.6 Higher abelian Chern-Simons theory in $d = 4k + 3$	727	
5.6	Higher	Wess-Zumino-Witten field theory	729	
	5.6.1	Introduction: Traditional WZW and the need for higher WZW	729	
	5.6.2	Lie n -algebraic formulation of perturbative higher WZW	730	

5.6.3	Boundary conditions and brane intersection laws	733
5.6.4	Example: Super p -branes and their intersection laws	736
5.6.4.1	Σ -model super p -branes — The old brane scan	738
5.6.4.2	Type IIA superstring ending on D-branes and the D0-brane condensate . . .	740
5.6.4.3	Type IIB superstring ending on D-branes and S-duality	742
5.6.4.4	The M-theory 5-brane and the M-theory super Lie algebra	743
5.6.4.5	The complete brane bouquet of string/M-theory	745
5.7	Local boundary and defect prequantum field theory	747
5.7.1	Vacuum defects from spontaneous symmetry breaking	748
5.7.2	Higher Chern-Simons local prequantum boundary field theory	750
5.7.2.1	Survey: towers of boundaries, corners, ... and of circle reductions	750
5.7.2.2	$d = n + 1$: Universal topological Yang-Mills theory	752
5.7.2.3	$d = n + 0$: Higher Chern-Simons field theories	753
5.7.2.4	$d = n - 1$: Topological Chern-Simons boundaries	755
5.7.2.5	$d = n - k$: Holonomy defects	757
5.7.2.6	$d = n - 1$: Wess-Zumino-Witten field theories	758
5.7.2.7	$d = n - 2$: Wilson loop/Wilson surface field theories	760
6	Outlook: Motivic quantization of local prequantum field theory	763
6.0.3	Cohomological quantization of correspondences in a cohesive slice	763
6.0.4	The quantum particle at the boundary of the string	766
6.0.4.1	Holographic geometric quantization of Poisson manifolds	767
6.0.4.2	D-brane charge	769
6.0.5	The quantum string at the boundary of the membrane	769

1 Introduction

In 1.1 we motivate the formalization of physics within higher differential geometry. Then section 1.2 is a lecture-note style introduction to the formulation of physics in terms of cohesive higher differential geometry. This serves as a warm-up for the general abstract discussion in the main sections to follow and is meant to illustrate the connection of cohesive higher geometry to traditional discussion notably of classical mechanics 1.2.10 and of classical field theory 1.2.11.

1.1 Motivation

In the year 1900, at the International Congress of Mathematics in Paris, David Hilbert stated his famous list of 23 central open questions of mathematics [Hi1900]. Among them, the sixth problem (see [Cor04] for a review) has maybe received the least attention from mathematicians, but is arguably the one that Hilbert himself regarded as the most valuable: “From all the problems in the list, the sixth is the only one that continually engaged [Hilbert’s] efforts over a very long period, at least between 1894 and 1932.” [Cor06]. Hilbert stated the problem as follows¹ (the boldface emphasis is ours):

Hilbert’s mathematical problem 6. *To treat by means of axioms, those physical sciences in which mathematics plays an important part.*

Hilbert went on to specify how such axiomatization should proceed:

*try first by a **small number of axioms** to include as large a class as possible of physical phenomena, and then by adjoining new axioms to arrive gradually at the more special theories.*

Finally there one more remark:

*take account not only of those theories coming near to reality, but also, as in geometry, all **logically possible theories** .*

Since then, various aspects of physics have been given a mathematical formulation. The following table, necessarily incomplete, gives a broad idea of central concepts in theoretical physics and the mathematics that captures them.

	physics	maths	
	<i>prequantum physics</i>	<i>differential geometry</i>	1.2
18xx-19xx	mechanics	symplectic geometry	1.2.10
1910s	gravity	Riemannian geometry	1.2.12.2
1950s	gauge theory	Chern-Weil theory	1.2.9
2000s	higher gauge theory	differential cohomology	1.2.6
	<i>quantum physics</i>	<i>noncommutative algebra</i>	6
1920s	quantum mechanics	operator algebra	
1960s	local observables	co-sheaf theory	
1990s-2000s	local field theory	(∞, n) -category theory	

These are traditional solutions to aspects of Hilbert’s sixth problem. Two points are noteworthy: on the one hand the items in the list involve crown jewels of mathematics; on the other hand their appearance is somewhat unconnected and remains piecemeal.

¹I am grateful to Hisham Sati and to David Corfield for discussion of this point.

Towards the end of the 20th century, William Lawvere, the founder of categorical logic and of categorical algebra, aimed for a more encompassing answer that rests the axiomatization of physics on a decent unified foundation. He suggested to

1. rest the foundations of mathematics itself in topos theory [Law65];
2. build the foundations of physics *synthetically* inside topos theory by
 - (a) imposing properties on a topos which ensure that the objects have the structure of *differential geometric spaces* [Law98];
 - (b) formalizing classical mechanics on this basis by universal constructions (“Categorical dynamics” [Law67], “Toposes of laws of motion” [Law97]).

While this is a grandiose plan, we have to note that it falls short in two respects:

1. Modern mathematics naturally wants foundations not in topos theory, but in *higher topos theory* ([L-Topos, UFP13]).
2. Modern physics needs to refine classical mechanics to *quantum mechanics* and *quantum field theory* at small length scales/high energy scales (e.g. [Fe85, SaSc11a]).

This book is about refining Lawvere’s synthetic approach on Hilbert’s sixth problem from classical physics formalized in synthetic differential geometry axiomatized in topos theory to high energy physics formalized in higher differential geometry axiomatized in higher topos theory. Moreover, following Hilbert’s problem description to consider “all logically possible theories”, we consider also string theoretic physics [DeMo99, Po01].

The central claim for which we accumulate evidence is this:

Claim 1.1.1. *In cohesive ∞ -topos theory-foundations fundamental physics is synthetically axiomatized*

1. *naturally – the axioms are simple, elegant and meaningful;*
2. *faithfully – the axioms capture the deep nontrivial phenomena.*

We now give more detailed motivation for this development (see also [Sc13d]).

- In 1.1.1 we observe that what in physics is called the *gauge principle* is already what in mathematics is the principle of *homotopy theory*.
- While the gauge principle is widely hailed as the central principle of modern physics, many discussions of mathematical physics in fact restrict attention to *perturbation theory* where only the infinitesimal approximation, the tangents to global physical effects are retained. From this perspective the true global effects of physics appear as if a departure from the normal and are accordingly called *anomalies*. While this is a useful perspective for many computations and often a good approximations to a complicated reality, a fundamental formulation of fundamental physics must instead take all these global effects naturally into account from the start. For practical matters this is the central reason for the application of higher differential geometry and differential cohomology applied to physics: it is the theory of global effects and of anomaly cancellation in field theory. This we come to in 1.1.2.
- When one explores fundamental physics it is noteworthy that among all the many possible kinds of action functionals and hence of theories of physics, some appears more “naturally” than others. We observe that in higher differential geometry the natural action functionals are induced from the theory of characteristic classes, primary, secondary, tertiary, etc. and their differential refinement, hence from higher Chern-Weil theory. This we consider in 1.1.3.
- Finally, for the inclined reader, we offer a more philosophical motivation, in 1.1.4.

1.1.1 The gauge principle and geometric homotopy theory

Modern physics rests on a few basic principles, among them the *gauge principle* (e.g. [Gr92]) and the *principle of locality*. We indicate here how these two principles imply that spaces of physical fields are *higher moduli stacks* given by *cohesive ∞ -groupoids*.

We start with the general statement and then look at its incarnations following the history of physics.

General discussion The gauge principle says that configurations of physical fields may be equivalent without being equal, there may be *gauge transformations* which turn one field configuration into a gauge equivalent one. In mathematical terms this means that fields in physics do not quite form a set, but that *fields form a groupoid* or equivalently that *fields form a homotopy 1-type*. In addition, by the variational principle of extremal action, the groupoid of field configurations is equipped with a differentiable (smooth) structure. In mathematical terms this says that *fields form a Lie groupoid* or more accurately that given a field theory there is a *moduli stack of fields* or a *geometric homotopy 1-type* of fields.

In much of the literature this moduli stack is considered (only) in its first order infinitesimal approximation, its associated Lie algebroid. This, or rather its algebra of functions, is famous in the physics literature as the *BRST complex* of a gauge field theory [HeTe92]. The cotangents to the gauge transformations, hence to the morphisms in the Lie groupoid of fields, are known as the *ghost fields*.

The gauge principle applies also to gauge transformations themselves: there are field theories where it is wrong to say that two gauge transformation between two given field configurations are equal or not, and where instead one needs to ask whether they are related by a *gauge-of-gauge equivalence*. The same applies ad infinitum, to ever higher order gauge transformations. Mathematically this means that field configurations may not form just a groupoid, but what is called an *∞ -groupoid* or *homotopy type*. Equipped with the smooth structure on the space of fields which is necessary for speaking about infinitesimal variations of fields, this says that there is a *moduli ∞ -stack* of fields or a *geometric homotopy type* of fields.

In much of the literature, again, this higher stack of fields is considered (only) in its first order infinitesimal approximation, its associated L_∞ -algebroid. This, or rather its algebra of functions, is famous in the physics literature as the *BV-BRST complex* (see e.g. [Paug11]). Here the co-tangents to the k -th order gauge-of-gauge transformations (the k -morphisms in the ∞ -groupoid of fields) are known as the k th order “ghost-of-ghost fields”.

In conclusion, the *gauge principle* in physics means that the collection of physical fields in a field theory is what mathematically is called a *higher moduli stack* or *geometric homotopy type* or what we will refer to here as a *cohesive ∞ -groupoid*.

Evident as this is, it is not much amplified in traditional physics textbooks. This has two causes. One is that many discussions of field theory rest on the approximation of perturbation theory, where many subtleties go away, and where discussion of global effects is often postponed to the extent that they are either forgotten or left to the esoteric-seeming literature on “anomalies”. Another cause is that often the nature of the gauge principle is actively misunderstood: often one sees texts claiming that gauge invariance is just a “redundancy” in the description of a physics, insinuating that one might just as well pass to the set of gauge equivalence classes. And this is not true: passing to gauge equivalence classes leads to violation of the other principle of modern physics, the principle of locality. For reconstructing non-trivial global gauge field configurations (often known as “instantons” in the physics literature) from local data, it is crucial to retain all the information about the gauge equivalences, for it is the way in which these serve to glue local gauge field data to global data that determines the global field content. This “gluing” is what in mathematics is often referred to as “descent” and it is the hallmark of higher stack theory/higher topos theory. A higher stack is a local assignment of ∞ -groupoids/homotopy types which satisfies descent, hence which globally glues.

Therefore the gauge principle and the principle of locality combines means that spaces of fields in physics form higher geometric stacks.

Instances of gauge theory Around 1850 Maxwell realized that the field strength of the electromagnetic field is modeled by what today we call a closed differential 2-form on spacetime. In the 1930s Dirac observed that in the presence of electrically charged quantum particles such as electrons, this 2-form is more precisely the *curvature* 2-form of a $U(1)$ -principal bundle with connection.

In modern terms this, in turn, means equivalently that the electromagnetic field is modeled by a degree 2-cocycle in (ordinary) *differential cohomology*. This is a differential refinement of the degree-2 integral cohomology that classifies the underlying $U(1)$ -principal bundles themselves via what mathematically is their *Chern class* and what physically is the topological *magnetic charge*. A coboundary in degree-2 differential cohomology is, mathematically, a smooth isomorphism of bundles with connection, hence, physically, is a *gauge transformation* between field configurations. Therefore classes in differential cohomology characterize the *gauge-invariant* information encoded in gauge field configurations, such as the electromagnetic field.

Meanwhile, in 1915, Einstein had identified also the field strength of the field of gravity as the $\mathfrak{so}(d, 1)$ -valued curvature 2-form of the canonical $O(d, 1)$ -principal bundle with connection on a $d + 1$ -dimensional spacetime Lorentzian manifold. This is a cocycle in differential *nonabelian* cohomology: in Chern-Weil theory.

In the 1950s Yang-Mills-theory identified the field strength of all the gauge fields in the standard model of particle physics as the $\mathfrak{u}(n)$ -valued curvature 2-forms of $U(n)$ -principal bundles with connection. This is again a cocycle in differential nonabelian cohomology.

Entities of ordinary gauge theory

Lie algebra \mathfrak{g} with gauge Lie group G — connection with values in \mathfrak{g} on G -principal bundle over a smooth manifold X

It is noteworthy that already in this mathematical formulation of experimentally well-confirmed fundamental physics the seed of higher differential cohomology is hidden: Dirac had not only identified the electromagnetic field as a line bundle with connection, but he also correctly identified (rephrased in modern language) its underlying cohomological Chern class with the (physically hypothetical but formally inevitable) magnetic charge located in spacetime. But in order to make sense of this, he had to resort to removing the support of the magnetic charge density from the spacetime manifold, because Maxwell's equations imply that at the support of any magnetic charge the 2-form representing the field strength of the electromagnetic field is in fact not closed and hence in particular not the curvature 2-form of an ordinary connection on an ordinary bundle.

In [Fr00] Dirac's old argument was improved by refining the model for the electromagnetic field one more step: Freed observes that the charge current 3-form is itself to be regarded as a curvature, but for a connection on a circle 2-bundle with connection – also called a bundle gerbe –, which is a cocycle in degree-3 ordinary differential cohomology. Accordingly, the electromagnetic field is fundamentally not quite a line bundle, but a *twisted bundle* with connection, with the twist being the magnetic charge 3-cocycle. Freed shows that this perspective is inevitable for understanding the quantum anomaly of the action functional for electromagnetism is the presence of magnetic charge.

In summary, the experimentally verified models, to date, of fundamental physics are based on the notion of (twisted) $U(n)$ -principal bundles with connection for the Yang-Mills field and $O(d, 1)$ -principal bundles with connection for the description of gravity, hence on nonabelian differential cohomology in degree 2 (possibly with a degree-3 twist).

In attempts to better understand the structure of these two theories and their interrelation, theoretical physicists were led to consider variations and generalizations of them that are known as *supergravity* and *string theory* [DeMo99]. In these theories the notion of gauge field turns out to generalize: instead of just Lie algebras, Lie groups and 1-form connections with values in these, one finds structures called *Lie 2-algebras*, *Lie 2-groups* and the gauge fields themselves are given by differential 2-forms values in these.

Entities of 2-gauge theory

Lie 2-algebra \mathfrak{g} with gauge Lie 2-group G — connection with values in \mathfrak{g} on a G -principal 2-bundle/gerbe over an orbifold X

Notably the fundamental string is charged under a field called the *Kalb-Ramond field* or *B-field* which is modeled by a $\mathbf{BU}(1)$ -principal 2-bundle with connection, where $\mathbf{BU}(1)$ is the Lie 2-group delooping of the circle group: the circle Lie 2-group. Its Lie 2-algebra $\mathbf{Bu}(1)$ is given by the differential crossed module $[\mathfrak{u}(1) \rightarrow 0]$ which has $\mathfrak{u}(1)$ shifted up by one in homological degree.

So far all these differential cocycles were known and understood mostly as concrete constructs, without making their abstract home in differential cohomology explicit. It is the next gauge field that made Freed and Hopkins propose [FrHo00] that the theory of differential cohomology is generally the formalism that models gauge fields in physics:

The superstring is charged also under what is called the *RR-field*, a gauge field modeled by cocycles in differential K-theory. In even degrees we may think of this as a differential cocycle whose curvature form has coefficients in the L_∞ -algebra $\bigoplus_{n \in \mathbb{N}} \mathbf{B}^{2n}\mathfrak{u}(1)$. Here $\mathbf{B}^{2n}\mathfrak{u}(1)$ is the abelian $2n$ -Lie algebra whose underlying complex is concentrated in degree $2n$ on \mathbb{R} . So fully generally, one finds *∞ -Lie algebras*, *∞ -Lie groups* and gauge fields modeled by connections with values in these.

Entities of general gauge theory

∞ -Lie algebra \mathfrak{g} with gauge ∞ -Lie group G — connection with values in \mathfrak{g} on a G -principal ∞ -bundle over a smooth ∞ -groupoid X

Apart from generalizing the notion of gauge Lie groups to Lie 2-groups and further, structural considerations in fundamental physics also led theoretical physicists to consider models for spacetime that are more general than the notion of a smooth manifold. In string theory spacetime is allowed to be more generally an orbifold or a generalization thereof, such as an orientifold. The natural mathematical model for these generalized spaces are Lie groupoids or, essentially equivalently, *differentiable stacks*.

It is noteworthy that the notions of generalized gauge groups and the generalized spacetime models encountered this way have a natural common context: all of these are examples of *smooth ∞ -groupoids*. There is a natural mathematical concept that serves to describe contexts of such generalized spaces: a *cohesive ∞ -topos*. The notion of *differential cohomology in a cohesive ∞ -topos* provides a unifying perspective on the mathematical structure encoding the generalized gauge fields and generalized spacetime models encountered in modern theoretical physics in such a general context.

1.1.2 Global effects and anomaly cancellation

One may wonder to which extent the higher gauge fields, that above in 1.1.1 we said motivate the theory of higher differential cohomology, can themselves be motivated within physics. It turns out that an important class of examples is required already by consistency of the quantum mechanics of higher dimensional fermionic (“spinning”) quantum objects.

We indicate now how the full description of this *quantum anomaly cancellation* forces one to go beyond classical Chern-Weil theory to a more comprehensive theory of higher differential cohomology.

Consider a smooth manifold X . Its tangent bundle TX is a real vector bundle of rank $n = \dim X$. By the classical theorem which identifies isomorphism classes of rank- n real vector bundles with homotopy classes of *continuous* maps to the classifying space $BO(n)$, for $O(n)$ the orthogonal group,

$$\text{VectBund}(X)/\sim \simeq [X, BO],$$

we have that TX is classified by a continuous map which we shall denote by the same symbol

$$TX : X \rightarrow BO(n).$$

Notice that this map takes place after passing from smooth spaces to just topological spaces. A central theme of our discussion later on are first *smooth* and then *differential* refinements of such maps.

A standard question to inquire about X is whether it is orientable. If so, a *choice* of orientation is, in terms of this classifying map, given by a lift through the canonical map $BSO(n) \rightarrow BO(n)$ from the classifying

space of the *special* orthogonal group. Further, we may ask if X admits a *Spin-structure*. If so, a choice of Spin-structure corresponds to a further lift through the canonical map $B\text{Spin}(n) \rightarrow BO(n)$ from the classifying space of the Spin-group, which is the universal simply connected cover of the special orthogonal group. (Details on these basic notions are reviewed at the beginning of 5 below.)

These lifts of structure groups are just the first steps through a whole tower of higher group extensions, called the *Whitehead tower* of $BO(n)$, as shown in the following picture. Here String is a *topological group* which is the universal 3-connected cover of Spin, and then Fivebrane is the universal 7-connected cover of String.

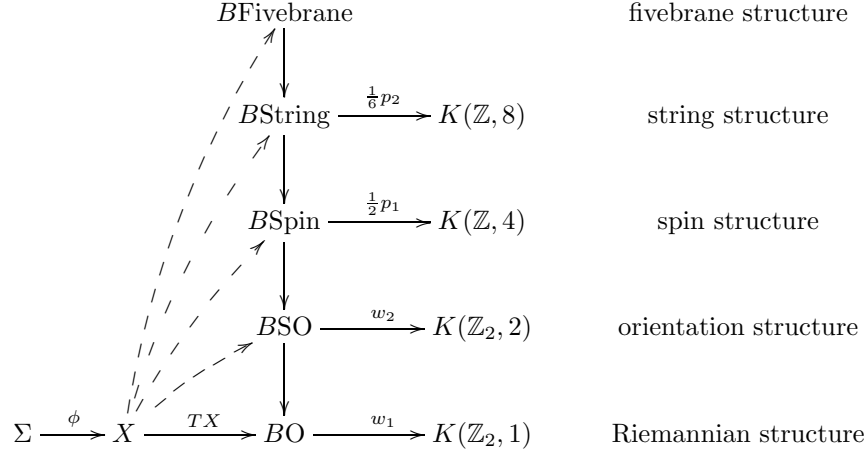

Here all subdiagrams of the form

$$\begin{array}{ccc}
 B\hat{G} & & \\
 \downarrow & & \\
 BG & \xrightarrow{c} & K(A, n)
 \end{array}$$

are homotopy fiber sequences. This means that $B\hat{G}$ is the homotopy fiber of the characteristic map c and \hat{G} itself is the homotopy fiber of the looping Ωc of c . By the universal property of the homotopy pullback, this implies the obstruction theory for the existence of these lifts. The first two of these are classical. For instance the orientation structure exists if the *first Stiefel-Whitney class* $[w_1(TX)] \in H^1(X, \mathbb{Z}_2)$ is trivial. Then a Spin-structure exists if moreover the *second Stiefel-Whitney class* $[w_2(TX)] \in H^2(X, \mathbb{Z}_2)$ is trivial.

Analogously, a *string structure* exists on X if moreover the *first fractional Pontryagin class* $[\frac{1}{2}p_1(TX)] \in H^4(X, \mathbb{Z})$ is trivial, and if so, a *fivebrane structure* exists if moreover the *second fractional Pontryagin class* $[\frac{1}{6}p_2(TX)] \in H^8(X, \mathbb{Z})$ is trivial.

The names of these structures indicate their role in quantum physics. Let Σ be a $d + 1$ -dimensional manifold and assume now that also X is smooth. Then a smooth map $\phi : \Sigma \rightarrow X$ may be thought of as modelling the trajectory of a d -dimensional object propagating through X . For instance for $d = 0$ this would be the trajectory of a point particle, for $d = 1$ it would be the worldsheet of a *string*, and for $d = 5$ the 6-dimensional worldvolume of a *5-brane*. The intrinsic “spin” of point particles and their higher dimensional analogs is described by a spinor bundle $S \rightarrow \Sigma$ equipped for each $\phi : \Sigma \rightarrow X$ with a Dirac operator D_{ϕ^*TX} that is twisted by the pullback of the tangent bundle of X along ϕ . The fermionic part of the *path integral* that gives the quantum dynamics of this setup computes the analog of the determinant of this Dirac operator, which is an element in a complex line called the *Pfaffian line* of D_{ϕ^*TX} . As ϕ varies, these Pfaffian lines arrange into a line bundle on the mapping space

$$\begin{array}{ccc}
 \{\text{Pfaff}(D_{\phi^*TX})\} & & \\
 \downarrow & & \\
 \{\phi : \Sigma \rightarrow X\} & \xlongequal{\quad} & \text{SmthMaps}(\Sigma, X) \xrightarrow{\text{tg}_\Sigma(c)} K(\mathbb{Z}, 2)
 \end{array}$$

Since the result of the fermionic part of the path integral is therefore a section of this line bundle, the resulting effective action functional can be a well defined function only if this line bundle is trivializable, hence if its Chern class vanishes. Therefore the Chern class of the Pfaffian line bundle over the bosonic configuration space is called the *global quantum anomaly* of the system. It is an obstruction to the existence of quantum dynamics of d -dimensional objects with spin on X .

Now, it turns out that this Chern class is the *transgression* $\text{tg}_\Sigma(c)$ of the corresponding class c appearing in the picture of the Whitehead tower above. Therefore the vanishing of these classes implies the vanishing of the quantum anomaly.

For instance a choice of a *spin structure* on X cancels the global quantum anomaly of the quantum spinning particle. Then a choice of *string structure* cancels the global quantum anomaly of the quantum spinning string, and a choice of *fivebrane structure* cancels the global quantum anomaly of the quantum spinning 5-brane.

However, the Pfaffian line bundle turns out to be canonically equipped with more refined differential structure: it carries a *connection*. Moreover, in order to obtain a consistent quantum theory it needs to be trivialized as a bundle with connection.

For the Pfaffian line bundle with connection still to be the transgression of the corresponding obstruction class on X , evidently the entire story so far needs to be refined from cohomology to a differentially refined notion of cohomology.

Classical Chern-Weil theory achieves this, in parts, for the first few steps through the Whitehead tower (see [GHV73] for a classical textbook reference and [HoSi05] for the refinement to differential cohomology that we need here). For instance, since maps $X \rightarrow B\text{Spin}$ classify Spin-principal bundles on X , and since Spin is a Lie group, it is clear that the corresponding differential refinement is given by Spin-principal connections. Write $H^1(X, \text{Spin})_{\text{conn}}$ for the equivalence classes of these structures on X .

For every $n \in \mathbb{N}$ there is a notion of differential refinement of $H^n(X, \mathbb{Z})$ to the *differential cohomology group* $H^n(X, \mathbb{Z})_{\text{conn}}$. These groups fit into square diagrams as indicated on the right of the following diagram.

$$\begin{array}{ccc}
 H^1_{\text{conn}}(X, \text{Spin}) & \xrightarrow{[\frac{1}{2}\hat{p}_1]} & H^4_{\text{diff}}(X, \mathbb{Z}) \\
 & \swarrow \text{curvature} & \searrow \text{top. class} \\
 & \Omega^4_{\text{cl}}(X) & H^4(X, \mathbb{Z}) \\
 & \searrow & \swarrow \\
 & H^4_{\text{dR}}(X) \simeq H^4(X, \mathbb{R}) &
 \end{array}$$

As shown there, an element in $H^n_{\text{diff}}(X, \mathbb{Z})$ involves an underlying ordinary integral class, but also a differential n -form on X such that both structures represent the same class in real cohomology (using the de Rham isomorphism between real cohomology and de Rham cohomology). The differential form here is to be thought of as a *higher curvature form* on a higher line bundle corresponding to the given integral cohomology class.

Finally, the refined form of classical Chern-Weil theory provides differential refinements for instance of the first fractional Pontryagin class $[\frac{1}{2}p_1] \in H^4(X, \mathbb{Z})$ to a differential class $[\frac{1}{2}\hat{p}_1]$ as shown in the above diagram. This is the differential refinement that under transgression produces the differential refinement of our Pfaffian line bundles.

But this classical theory has two problems.

1. Beyond the Spin-group, the topological groups String, Fivebrane etc. do not admit the structure of finite-dimensional Lie groups anymore, hence ordinary Chern-Weil theory fails to apply.
2. Even in the situation where it does apply, ordinary Chern-Weil theory only works on cohomology classes, not on cocycles. Therefore the differential refinements cannot see the homotopy fiber sequences anymore, that crucially characterized the obstruction problem of lifting through the Whitehead tower.

The source of the first problem may be thought to be the evident fact that the category \mathbf{Top} of topological spaces does not encode smooth structure. But the problem goes deeper, even. In homotopy theory, \mathbf{Top} is not even about topological structure. Rather, it is about homotopies and *discrete* geometric structure.

One way to make this precise is to say that there is a *Quillen equivalence* between the model category structures on topological spaces and on simplicial sets.

$$\mathbf{Top} \begin{array}{c} \xleftarrow{|-|} \\ \xrightarrow{\text{Sing}} \end{array} \mathbf{sSet} \quad \text{Ho}(\mathbf{Top}) \simeq \text{Ho}(\mathbf{sSet}).$$

Here the *singular simplicial complex functor* Sing sends a topological space to the simplicial set whose k -cells are maps from the topological k -simplex into X .

In more abstract modern language we may restate this as saying that there is an equivalence

$$\mathbf{Top} \xrightarrow[\simeq]{\Pi} \infty\mathbf{Grpd}$$

between the homotopy theory of topological spaces and that of ∞ -groupoids, exhibited by forming the *fundamental ∞ -groupoid* of X .

To break this down into a more basic statement, let $\mathbf{Top}_{\leq 1}$ be the subcategory of homotopy 1-types, hence of these topological spaces for which only the 0th and the first homotopy groups may be nontrivial. Then the above equivalence restricts to an equivalence

$$\mathbf{Top}_{\leq 1} \xrightarrow[\simeq]{\Pi} \mathbf{Grpd}$$

with ordinary groupoids. Restricting this even further to (pointed) connected 1-types, hence spaces for which only the first homotopy group may be non-trivial, we obtain an equivalence

$$\mathbf{Top}_{1,\text{pt}} \xrightarrow[\simeq]{\pi_1} \mathbf{Grp}$$

with the category of groups. Under this equivalence a connected 1-type topological space is simply identified with its first fundamental group.

Manifestly, the groups on the right here are just bare groups with no geometric structure; or rather with *discrete* geometric structure. Therefore, since the morphism Π is an equivalence, also \mathbf{Top}_1 is about *discrete* groups, $\mathbf{Top}_{\leq 1}$ is about *discrete* groupoids and \mathbf{Top} is about *discrete ∞ -groupoids*.

There is a natural solution to this problem. This solution and the differential cohomology theory that it supports is the topic of this book.

The solution is to equip discrete ∞ -groupoids A with *smooth structure* by equipping them with information about what the *smooth families* of k -morphisms in it are. In other words, to assign to each smooth parameter space U an ∞ -groupoid of smoothly U -parameterized families of cells in A .

If we write \mathbf{A} for A equipped with smooth structure, this means that we have an assignment

$$\mathbf{A} : U \mapsto \mathbf{A}(U) =: \text{Maps}(U, A)_{\text{smooth}} \in \infty\mathbf{Grpd}$$

such that $\mathbf{A}(*) = A$.

Notice that here the notion of smooth maps into A is not defined before we declare \mathbf{A} , rather it is defined *by* declaring \mathbf{A} . A more detailed discussion of this idea is below in 1.2.4.1.

We can then define the homotopy theory of *smooth ∞ -groupoids* by writing

$$\text{Smooth}\infty\mathbf{Grpd} := L_W\text{Funct}(\text{SmoothMfd}^{\text{op}}, \mathbf{sSet}).$$

Here on the right we have the category of contravariant functors on the category of smooth manifolds, such as the \mathbf{A} from above. In order for this to inform this simple construction about the local nature of smoothness,

we need to formally invert some of the morphisms between such functors, which is indicated by the symbol L_W on the left. The set of morphisms W that are to be inverted are those natural transformation that are *stalkwise* weak homotopy equivalences of simplicial sets.

We find that there is a canonical notion of *geometric realization* on smooth ∞ -groupoids

$$|-| : \text{Smooth}\infty\text{Grpd} \xrightarrow{\Pi} \infty\text{Grpd} \xrightarrow{|-|} \text{Top},$$

where Π is the derived left adjoint to the embedding

$$\text{Disc} : \infty\text{Grpd} \hookrightarrow \text{Smooth}\infty\text{Grpd}$$

of bare ∞ -groupoids as discrete smooth ∞ -groupoids. We may therefore ask for *smooth refinements* of given topological spaces X , by asking for smooth ∞ -groupoids \mathbf{X} such that $|\mathbf{X}| \simeq X$.

A simple example is obtained from any Lie algebra \mathfrak{g} . Consider the functor $\exp(\mathfrak{g}) : \text{SmoothMfd}^{\text{op}} \rightarrow \text{sSet}$ given by the assignment

$$\exp(\mathfrak{g}) : U \mapsto ([k] \mapsto \Omega_{\text{flat,vert}}^1 U \times \Delta^k, \mathfrak{g}),$$

where on the right we have the set of differential forms on the parameter space times the smooth k -simplex which are flat and vertical with respect to the projection $U \times \Delta^k \rightarrow U$.

We find that the 1-truncation of this smooth ∞ -groupoid is the Lie groupoid

$$\tau_1 \exp(\mathfrak{g}) = \mathbf{B}G$$

that has a single object and whose morphisms form the simply connected Lie group G that integrates \mathfrak{g} . We may think of this Lie groupoid also as the *moduli stack* of smooth G -principal bundles. In particular, this is a smooth refinement of the classifying space for G -principal bundles in that

$$|\mathbf{B}G| \simeq BG.$$

So far this is essentially what classical Chern-Weil theory can already see. But smooth ∞ -groupoids now go much further.

In the next step there is a *Lie 2-algebra* $\mathfrak{g} = \mathbf{string}$ such that its exponentiation

$$\tau_2 \exp(\mathbf{string}) = \mathbf{BString}$$

is a smooth 2-groupoid, which we may think of as the *moduli 2-stack of String-principal* which is a smooth refinement of the String-classifying space

$$|\mathbf{BString}| \simeq BString.$$

Next there is a Lie 6-algebra $\mathfrak{g} = \mathbf{fivebrane}$ such that

$$\tau_6 \exp(\mathbf{fivebrane}) = \mathbf{BFivebrane}$$

with

$$|\mathbf{BFivebrane}| \simeq BFivebrane.$$

Moreover, the characteristic maps that we have seen now refine first to smooth maps on these moduli stacks, for instance

$$\frac{1}{2}\mathbf{p}_1 : \mathbf{BSpin} \rightarrow \mathbf{B}^3U(1),$$

and then further to *differential* refinement of these maps

$$\frac{1}{2}\hat{\mathbf{p}}_1 : \mathbf{BSpin}_{\text{conn}} \rightarrow \mathbf{B}^3U(1)_{\text{conn}},$$

where now on the left we have the moduli stack of smooth Spin-connections, and on the right the moduli 3-stack of *circle n -bundles with connection*.

A detailed discussion of these constructions is below in 5.1.

In addition to capturing smooth and differential refinements, these constructions have the property that they work not just at the level of cohomology classes, but at the level of the full cocycle ∞ -groupoids. For instance for X a smooth manifold, postcomposition with $\frac{1}{2}\hat{\mathbf{p}}$ may be regarded not only as inducing a function

$$H_{\text{conn}}^1(X, \text{Spin}) \rightarrow H_{\text{conn}}^4(X)$$

on cohomology sets, but a morphism

$$\frac{1}{2}\hat{\mathbf{p}}(X) : \mathbf{H}^1(X, \text{Spin}) \rightarrow \mathbf{H}^3(X, \mathbf{B}^3U(1)_{\text{conn}})$$

from the groupoid of smooth principal Spin-bundles with connection to the 3-groupoid of smooth circle 3-bundles with connection. Here the boldface $\mathbf{H} = \text{Smooth}\infty\text{Grpd}$ denotes the ambient ∞ -topos of smooth ∞ -groupoids and $\mathbf{H}(-, -)$ its hom-functor.

By this refinement to cocycle ∞ -groupoids we have access to the homotopy fibers of the morphism $\frac{1}{2}\hat{\mathbf{p}}_1$. Before differential refinement the homotopy fiber

$$\mathbf{H}(X, \mathbf{B}\text{String}) \longrightarrow \mathbf{H}(X, \mathbf{B}\text{Spin}) \xrightarrow{\frac{1}{2}\hat{\mathbf{p}}_1} \mathbf{H}(X, \mathbf{B}^3U(1)) ,$$

is the 2-groupoid of smooth String-principal 2-bundles on X : smooth *string structures* on X . As we pass to the differential refinement, we obtain *differential string structures* on X

$$\mathbf{H}(X, \mathbf{B}\text{String}_{\text{conn}}) \longrightarrow \mathbf{H}(X, \mathbf{B}\text{Spin}_{\text{conn}}) \xrightarrow{\frac{1}{2}\hat{\mathbf{p}}_1} \mathbf{H}(X, \mathbf{B}^3U(1)_{\text{conn}}) .$$

A cocycle in the 2-groupoid $\mathbf{H}(X, \mathbf{B}\text{String}_{\text{conn}})$ is naturally identified with a tuple consisting of

- a smooth Spin-principal bundle $P \rightarrow X$ with connection ∇ ;
- the Chern-Simons 2-gerbe with connection $CS(\nabla)$ induced by this;
- a choice of trivialization of this Chern-Simons 2-gerbe and its connection.

We may think of this as a refinement of secondary characteristic classes: the first Pontryagin curvature characteristic form $\langle F_{\nabla} \wedge F_{\nabla} \rangle$ itself is constrained to vanish, and so the Chern-Simons form 3-connection itself constitutes cohomological data.

More generally, we have access not only to the homotopy fiber over the 0-cocycle, but may pick one cocycle in each cohomology class to a total morphism $H_{\text{diff}}^4(X) \rightarrow \mathbf{H}(X, \mathbf{B}^3U(1)_{\text{conn}})$ and consider the collection of all homotopy fibers over all connected components as the homotopy pullback

$$\begin{array}{ccc} \frac{1}{2}\hat{\mathbf{p}}_1 \text{Struct}_{\text{tw}}(X) & \longrightarrow & H_{\text{diff}}^4(X) \\ \downarrow & & \downarrow \\ \mathbf{H}(X, \mathbf{B}\text{Spin}_{\text{conn}}) & \xrightarrow{\frac{1}{2}\hat{\mathbf{p}}_1} & \mathbf{H}(X, \mathbf{B}^3U(1)_{\text{conn}}) \end{array} .$$

This yields the 2-groupoid of *twisted differential string structure*. These objects, and their higher analogs given by twisted differential fivebrane structures, appear in background field structure of the heterotic string and its magnetic dual, as discussed in [SSS09c].

These are the kind of structures that ∞ -Chern-Weil theory studies.

1.1.3 Hierarchies of natural action functionals

We present here a motivation for our constructions, starting from the observation that classical Chern-Weil theory induces action functionals of Chern-Simons type, and observing that this phenomenon ought to have certain natural generalizations.

First a brief word on the general context of quantum physics.

In recent years the notion of *topological quantum field theory* (TQFT) from physics has been fully formalized and made accessible to strong mathematical tools and classifications. In its refined variant of *fully local* or *extended* n -dimensional TQFT, the fundamental concept is that of a higher category, denoted Bord_n , whose ($k \leq n$)-cells are k -dimensional smooth manifolds with boundary and corners, and whose composition operation is gluing along these boundaries. The disjoint union of manifolds equips this with a symmetric monoidal structure. Then for another symmetric monoidal n -category $n\text{Vect}_{\text{fd}}$, whose k -cells one thinks of as higher order linear maps between n -categorical analogs of finite dimensional (or “fully dualizable”) vector spaces, an n -dimensional extended TQFT is formalized as an n -functor

$$Z : \text{Bord}_n \rightarrow n\text{Vect}$$

that respects this monoidal structure.

Here the higher order linear map $Z(\Sigma_{n-1})$ that is assigned to a *closed* $(n-1)$ -dimensional manifold Σ_{n-1} can typically canonically be identified with a vector space, and be interpreted as the *space of states* of the physical system described by Z , for field configurations over a space of shape Σ_{n-1} . Then for Σ_n a cobordism between two such closed $(n-1)$ -manifolds, $Z(\Sigma_n)$ identifies with a linear map from the space of states over the incoming to that over the outgoing boundary, and is interpreted as the (“time”-) *propagation* of states.

This idea is by now classical. A survey can for instance be found in [Ka10].

But beyond constituting a formalization of some concept motivated from physics, it is remarkable that this construction is itself entirely rooted in a universal construction in higher category theory, and would have eventually been discovered as such even in the absence of any motivation from physics. The notion of extended TQFT *derives* from higher category theory.

Namely, according to the celebrated result of [L-TFT], earlier hypothesized in [BaDo95], Bord_n is a *free construction* – essentially the *free symmetric monoidal n -category* generated by just the point. This means that symmetric monoidal maps $Z : \text{Bord}_n \rightarrow n\text{Vect}_{\text{fd}}$ are equivalently encoded by n -functors from the point $Z(*) : * \rightarrow n\text{Vect}_{\text{fd}}$, which in turn are, of course, canonically identified simply with n -vector spaces, the *n -vector space of states* assigned by Z to the point. This adjunction is both, an intrinsic characterization of Bord_n , as well as a full *classification* of extended TQFTs: these are entirely determined by their higher space of states. All the assignments on higher dimensional Σ are obtained by forming higher order *traces* on this single higher space of states over the point.

Here we will not further dwell on extended TQFT as such, but instead use this state of affairs to motivate an investigation of a *source of examples* of *natural* TQFTs. Because the TQFTs that actually appear in fundamental physics, even when including the families of theories found in the study of theory space away from the loci of experimentally observed theories, are far from being random TQFTs allowed by the above classification.

First of all, the TQFTs that do appear are typically theories that arise by a process of *quantization* from a local *action functional* on a space of field configurations (recalled below). Secondly, even among all TQFTs arising by quantization from local action functionals they are special, in that they have a natural formulation in differential geometry, something that we will make precise below. The typical action functional appearing in practice is not random, but follows some natural pattern.

One may therefore ask which principle it is that selects from a universal construction in higher category theory – that of free symmetric monoidal structure – a certain subclass of “natural” geometric examples. We will provide evidence here that this is another universal construction, but now in *higher topos theory: cohesion*.

Below in 3.9 (specifically in 3.9.11 and 3.9.12) we show that cohesion in an ∞ -topos induces, first, a notion of *differential characteristic maps*, via a generalized *Chern-Weil theory*, and, second, from each

such the corresponding spaces – in fact *moduli* ∞ -stacks – of higher gauge field configurations, and, third, canonically equips these with action functionals, via a generalized higher *Chern-Simons theory*. Moreover, it induces from any such a corresponding action functional of one dimension lower, via a generalized higher *Wess-Zumino-Witten theory*. And finally the process of (geometric) quantization of these functionals on moduli stacks is itself naturally induced in a cohesive context.

Geometric quantization For completeness, we briefly recall the basic ideas of *quantization* in its formalization known as *geometric quantization* (which we discuss in abstract cohesion below in 3.9.13 and in the traditional formulation in differential geometry in 4.4.20).

The input datum is, for a given manifold of the form $\Sigma = \Sigma_{n-1} \times [0, 1]$ a smooth space $\text{Conf}(\Sigma_n)$ of *field configurations* on Σ , equipped with a suitably smooth map, called the “action functional” of the theory,

$$S : \text{Conf}(\Sigma_n) \rightarrow \mathbb{R}$$

taking values in the real numbers.

From this input one first obtains the *covariant phase space* of the system, given as the variational *critical locus* of S , schematically the subspace

$$P = \{\phi \in \text{Conf}(\Sigma) \mid (dS)_\phi = 0\}$$

of field configurations on which the *variational* derivative dS of S vanishes. These field configurations are said to satisfy the *Euler-Lagrange equations of motion* of the dynamics encoded by S .

If S is a *local* action functional, in that it depends on the fields ϕ via an integral over Σ whose integrand only depends on finitely many derivatives of ϕ , then this space canonically carries a *pre-symplectic form*, a closed 2-form $\omega \in \Omega_{\text{cl}}^2(P)$.

A *symmetry* of the system is a vector field on P which is in the kernel of ω . The quotient of P by the flows of these symmetries is called the *reduced phase space*. This quotient is typically very ill-behaved if regarded in ordinary geometry, but is a natural nice space in higher geometry (modeled by *BV-BRST formalism*). The pre-symplectic form ω descends to a symplectic form ω_{red} on the reduced phase space.

A *geometric prequantization* of the symplectic smooth space $(P_{\text{red}}, \omega_{\text{red}})$ is now, if it exists, a choice of line bundle $E \rightarrow P_{\text{red}}$ with connection ∇ , such that $\omega = F_\nabla$ is the corresponding curvature 2-form. This becomes a *geometric quantization* proper when furthermore equipped with a choice of foliation of P_{red} by Lagrangian submanifolds (submanifolds of maximal dimension on which ω_{red} vanishes). This foliation is a choice of decomposition of phase space into “canonical coordinates and momenta” of the physical system.

Finally, the quantum space of states, $Z(\Sigma_{n-1})$, that is defined by this construction is the vector space of those sections of E that are covariantly constant along the leaves of the foliation.

The notion of fully local/extended TQFTs suggests that there ought to be an analogous fully local/extended version of geometric quantization, which produces not just the datum $Z(\Sigma_{n-1})$, but $Z(\Sigma_k)$ for all $0 \leq k \leq n$. By the above classification result it follows that the value for $k = 0$ alone will suffice to define the entire quantum theory. This should involve not just line bundles with connection, but higher analogs of these, called *circle* $(n - k)$ -*bundles with connection* or *bundle* $(n - k - 1)$ -*gerbes with connection*.

We discuss such a *higher geometric prequantization* axiomatically in 3.9.13, and discuss examples in 4.4.20 and 5.4.

Classical Chern-Weil theory and its shortcomings Even in the space of all topological local action functionals, those that typically appear in fundamental physics are special. The archetypical example of a TQFT is 3-dimensional Chern-Simons theory (see [Fr95] for a detailed review). Its action functional happens to arise from a natural construction in classical *Chern-Weil theory*. We now briefly summarize this process, which already produces a large family of natural topological action functionals on gauge equivalence classes of gauge fields. We then point out deficiencies of this classical theory, which are removed by lifting it to higher geometry.

A classical problem in topology is the classification of vector bundles over some topological space X . These are continuous maps $E \rightarrow X$ such that there is a vector space V , and an open cover $\{U_i \hookrightarrow X\}$, and such that over each patch we have fiberwise linear identifications $E|_{U_i} \simeq U_i \times V$. Examples include

- the tangent bundle TX of a smooth manifold X ;
- the canonical \mathbb{C} -line bundle over the 2-sphere, $S^3 \times_{S^1} \mathbb{C} \rightarrow S^2$ which is associated to the Hopf fibration.

A classical tool for studying isomorphism classes of vector bundles is to assign to them simpler *characteristic classes* in the ordinary integral cohomology of the base space. For vector bundles over the complex numbers these are the *Chern classes*, which are maps

$$[c_1] : \text{VectBund}_{\mathbb{C}}(X)/\sim \rightarrow H^2(X, \mathbb{Z})$$

$$[c_2] : \text{VectBund}_{\mathbb{C}}(X)/\sim \rightarrow H^4(X, \mathbb{Z})$$

etc. natural in X . If two bundles have differing characteristic classes, they must be non-isomorphic. For instance for \mathbb{C} -line bundles the first Chern-class $[c_1]$ is an isomorphism, hence provides a complete invariant characterization.

In the context of *differential geometry*, where X and E are taken to be smooth manifolds and the local identifications are taken to be smooth maps, one wishes to obtain *differential* characteristic classes. To that end, one can use the canonical inclusion $\mathbb{Z} \hookrightarrow \mathbb{R}$ of coefficients to obtain the map $H^{n+1}(X, \mathbb{Z}) \rightarrow H^{n+1}(X, \mathbb{R})$ from integral to real cohomology, and send any integral characteristic class $[c]$ to its real image $[c]_{\mathbb{R}}$. Due to the de Rham theorem, which identifies the real cohomology of a smooth manifold with the cohomology of its complex of differential forms,

$$H^{n+1}(X, \mathbb{R}) \simeq H_{\text{dR}}^{n+1}(X),$$

this means that for $[c]_{\mathbb{R}}$ one has representatives given by closed differential $(n+1)$ -forms $\omega \in \Omega_{\text{cl}}^{n+1}(X)$,

$$[c]_{\mathbb{R}} \sim [\omega].$$

But since the passage to real cohomology may lose topological information (all torsion group elements map to zero), one wishes to keep the information both of the topological characteristic class $[c]$ as well as of its “differential refinement” ω . This is accomplished by the notion of *differential cohomology* $H_{\text{diff}}^{n+1}(X)$ (see [HoSi05] for a review). These are families of cohomology groups equipped with compatible projections both to integral classes as well as to differential forms

$$\begin{array}{ccccc}
 & & H_{\text{diff}}^{n+1}(X) & & [\hat{c}] \\
 & \swarrow & & \searrow & \swarrow \\
 H^{n+1}(X, \mathbb{Z}) & & & & \Omega_{\text{cl}}^{n+1}(X) \\
 & \searrow & & \swarrow & \searrow \\
 & & H^{n+1}(X, \mathbb{R}) \simeq H_{\text{dR}}^{n+1}(X) & & [c]_{\mathbb{R}} \sim [\omega]
 \end{array}$$

Moreover, these differential cohomology groups come equipped with a notion of *volume holonomy*. For Σ_n an n -dimensional compact manifold, there is a canonical morphism

$$\int_{\Sigma} : H_{\text{diff}}^{n+1}(\Sigma) \rightarrow U(1)$$

to the circle group.

For instance for $n = 1$, we have that $H^2(X, \mathbb{Z})$ classifies circle bundles / complex line bundles over X , $H_{\text{diff}}^2(X)$ classifies such bundles *with connection* ∇ , and the map $\int_{\Sigma} : H_{\text{diff}}^2(\Sigma) \rightarrow U(1)$ is the *line holonomy* obtained from the *parallel transport* of ∇ over the 1-dimensional manifold Σ .

With such differential refinements of characteristic classes in hand, it is desirable to have them classify differential refinements of vector bundles. These are known as *vector bundles with connection*. We say a differential refinement of a characteristic class $[c]$ is a map $[\hat{c}]$ fitting into a diagram

$$\begin{array}{ccc} \text{VectBund}_{\text{conn}}(X)/\sim & \xrightarrow{[\hat{c}]} & H_{\text{diff}}^{n+1}(X) \\ \downarrow & & \downarrow \\ \text{VectBund}(X)/\sim & \xrightarrow{[c]} & H^{n+1}(X, \mathbb{Z}) \end{array},$$

where the vertical maps forget the differential refinement. Such a $[\hat{c}]$ contains information even when $[c] = 0$. Therefore one also calls $[\hat{c}]$ a *secondary characteristic class*.

All of this has a direct interpretation in terms of quantum gauge field theory.

- the elements in $\text{VectBund}_{\text{conn}}(X)/\sim$ are gauge equivalence classes of *gauge fields* on X (for instance the electromagnetic field, or nuclear force fields);
- the differential class $[\hat{c}]$ defines a canonical *action functional* $S_{[c]}$ on such fields, by composition with the volume holonomy

$$\exp(iS_c(-)) : \text{Conf}(\Sigma)/\sim := \text{VectBund}_{\text{conn}}(\Sigma)/\sim \xrightarrow{[\hat{c}]} H_{\text{diff}}^{n+1}(\Sigma) \xrightarrow{\int_{\Sigma}} U(1).$$

The action functionals that arise this way are of *Chern-Simons type*. If we write $A \in \Omega^1(\Sigma, \mathfrak{u}(n))$ for a differential form representing locally the connection on a vector bundle, then we have

- $\int_{\Sigma} c_1 : A \mapsto \exp(i \int_{\Sigma} \text{tr}(A));$
- $\int_{\Sigma} c_2 : A \mapsto \exp(i \int_{\Sigma} \text{tr}(A \wedge d_{\text{dR}} A + \frac{2}{3} \text{tr}(A \wedge A \wedge A));$
- etc.

Here the second expression, coming from the second Chern-class, is the standard action functional for 3-dimensional Chern-Simons theory. The first, coming from the first Chern-class, is a 1-dimensional Chern-Simons type theory. Next in the series is an action functional for a 5-dimensional Chern-Simons theory. Later we will see that by generalizing here from vector bundles to *higher bundles* of various kinds, a host of known action functionals for quantum field theories arises this way.

Despite this nice story, this traditional Chern-Weil theory has several shortcomings.

1. It is *not local*, related to the fact that it deals with cohomology classes $[c]$ instead of the cocycles c themselves. This means that there is no good obstruction theory and no information about the locality of the resulting QFTs.
2. It does not apply to *higher topological structures*, hence to *higher gauge fields* that take values in higher covers of Lie groups which are not themselves compact Lie groups anymore.
3. It is *restricted to ordinary differential geometry* and does not apply to variants such as supergeometry, infinitesimal geometry or derived geometry, all of which appear in examples of QFTs of interest.

Formulation in cohesive homotopy type theory We discuss now these problems in slightly more detail, together with their solution in *cohesive homotopy type theory*.

The problem with the locality is that every vector bundle is, by definition, *locally equivalent* to a trivial bundle. Also, locally on contractible patches $U \hookrightarrow X$ every integral cocycle becomes cohomologous to the

trivial cocycle. Therefore the restriction of a characteristic class to local patches retains no information at all

$$\begin{array}{ccc} \text{VectBund}(X)/\sim & \xrightarrow{[c]} & H^{n+1}(X, \mathbb{Z}) \\ \downarrow (-)|_U & & \downarrow (-)|_U \\ * & \xrightarrow{\text{Id}} & * \end{array}$$

Here we may think of the singleton $*$ as the class of the trivial bundle over U . But even though on U every bundle is equivalent to the trivial bundle, this has non-trivial gauge automorphisms

$$* \xrightarrow{g} * \quad g \in C^\infty(U, G := \text{GL}(V)).$$

These are not seen by traditional Chern-Weil theory, as they are not visible after passing to equivalence classes and to cohomology.

But by collecting this information over each U , it organizes into a *presheaf of gauge groupoids*. We shall write

$$\mathbf{BG} : U \mapsto \left\{ * \xrightarrow{g \in C^\infty(U, G)} * \right\} \in \text{Funct}(\text{SmthMfd}^{\text{op}}, \text{Grpd}).$$

In order to retain all this information, we may pass to the 2-category

$$\mathbf{H} := L_W \text{Func}(\text{SmthMfd}^{\text{op}}, \text{Grpd})$$

of such groupoid-valued functors, where we formally invert all those morphisms (natural transformations) in the class W of *stalkwise* equivalences of groupoids. This is called the *2-topos of stacks* on smooth manifolds.

For example we have

- $\mathbf{H}(U, \mathbf{BG}) \simeq \left\{ * \xrightarrow{g \in C^\infty(U, G)} * \right\}$
- $\pi_0 \mathbf{H}(X, \mathbf{BG}) \simeq \text{VectBund}(X)/\sim$

and hence the object $\mathbf{BG} \in \mathbf{H}$ constitutes a genuine smooth refinement of the classifying space for rank n -vector bundles, which sees not just their equivalence classes, but also their local smooth transformations.

The next problem of traditional Chern-Weil theory is that it cannot see beyond groupoids even in cohomology. Namely, under the standard nerve operation, groupoids embed into *simplicial sets* (described in more detail in 1.2.5.4 below)

$$N : \text{Grpd} \hookrightarrow \text{sSet}.$$

But simplicial sets model *homotopy theory*.

- There is a notion of homotopy groups π_k of simplicial sets;
- and there is a notion of *weak homotopy equivalences*, morphisms $f : X \rightarrow Y$ which induce isomorphisms on all homotopy groups.

Under the above embedding, groupoids yield only (and precisely) those simplicial sets, up to equivalence, for which only π_0 and π_1 are nontrivial. One says that these are *homotopy 1-types*. A general simplicial set presents what is called a *homotopy type* and may contain much more information.

Therefore we are led to refine the above construction and consider the simplicial category

$$\mathbf{H} := L_W \text{Func}(\text{SmthMfd}^{\text{op}}, \text{sSet})$$

of functors that send smooth manifolds to simplicial sets, where now we formally invert those morphisms that are stalkwise weak homotopy equivalences of simplicial sets.

This is called the ∞ -*topos of ∞ -stacks* on smooth manifolds.

For instance, there are objects $\mathbf{B}^n U(1)$ in this context which are smooth refinements of higher integral cohomology, in that

$$\pi_0 \mathbf{H}(X, \mathbf{B}^n U(1)) \simeq H^{n+1}(X, \mathbb{Z}).$$

Finally, in this construction it is straightforward to change the geometry by changing the category of geometric test spaces. For instance we may replace smooth manifolds here by supermanifolds or by formal (synthetic) smooth manifolds. In all these cases \mathbf{H} describes *homotopy types with differential geometric structure*. One of our main statements below is the following theorem.

These \mathbf{H} all satisfy a simple set of axioms for “cohesive homotopy types”, which were proposed for 0-types by Lawvere. In the fully homotopical context these axioms canonically induce in \mathbf{H}

- differential cohomology;
- higher Chern-Weil theory;
- higher Chern-Simons functionals;
- higher geometric prequantization.

This is such that it reproduces the traditional notions where they apply, and otherwise generalizes them beyond the realm of classical applicability.

Extended higher Chern-Simons theory It has become a familiar fact, known from examples as those indicated above, that there should be an n -dimensional topological quantum field theory Z_c associated to the following data:

1. a *gauge group* G : a Lie group such as $U(n)$; or more generally a higher smooth group, such as the smooth circle n -group $\mathbf{B}^{n-1}U(1)$ or the *String 2-group* or the smooth *Fivebrane 6-group* [SSS09c, FSS10];
2. a universal characteristic class $[c] \in H^{n+1}(BG, \mathbb{Z})$ and/or its image ω in real/de Rham cohomology,

where Z_c is a G -gauge theory defined naturally over all closed oriented n -dimensional smooth manifolds Σ_n , and such that whenever Σ_n happens to be the boundary of some manifold Σ_{n+1} the action functional on a field configuration ϕ is given by the integral of the pullback form $\hat{\phi}^* \omega$ (made precise below) over Σ_{n+1} , for some extension $\hat{\phi}$ of ϕ . These are *Chern-Simons type* gauge theories. See [Zan08] for a gentle introduction to the general idea of Chern-Simons theories.

Notably for G a connected and simply connected simple Lie group, for $c \in H^4(BG, \mathbb{Z}) \simeq \mathbb{Z}$ any integer – the “level” – and hence for $\omega = \langle -, - \rangle$ the Killing form on the Lie algebra \mathfrak{g} , this quantum field theory is the original and standard Chern-Simons theory introduced in [Wi89]. See [Fr95] for a comprehensive review. Familiar as this theory is, there is an interesting aspect of it that has not yet found attention, and which is an example of our constructions here.

To motivate this, it is helpful to look at the 3d Chern-Simons action functional as follows: if we write $H(\Sigma_3, \mathbf{B}G_{\text{conn}})$ for the set of gauge equivalence classes of G -principal connections ∇ on Σ_3 , then the (exponentiated) action functional of 3d Chern-Simons theory over Σ_3 is a function of sets

$$\exp(iS(-)) : H(\Sigma_3, \mathbf{B}G_{\text{conn}}) \rightarrow U(1).$$

Of course this function acts by picking a representative of the gauge equivalence class, given by a smooth 1-form $A \in \Omega^1(\Sigma_3, \mathfrak{g})$ and sending that to the element $\exp(2\pi i k \int_{\Sigma_3} \text{CS}(A)) \in U(1)$, where $\text{CS}(A) \in \Omega^3(\Sigma_3)$ is the Chern-Simons 3-form of A [ChSi74], that gives the whole theory its name. That this is well defined is the fact that for every gauge transformation $g : A \rightarrow A^g$, for $g \in C^\infty(\Sigma_3, G)$, both A as well as its gauge transform A^g , are sent to the same element of $U(1)$. A natural formal way to express this is to consider the *groupoid* $\mathbf{H}(\Sigma_3, \mathbf{B}G_{\text{conn}})$ whose objects are gauge fields A and whose morphisms are gauge transformations g as above. Then the fact that the Chern-Simons action is defined on individual gauge field configurations

while being invariant under gauge transformations is equivalent to the statement that it is a *functor*, hence a morphism of groupoids,

$$\exp(iS(-)) : \mathbf{H}(\Sigma_3, \mathbf{BG}_{\text{conn}}) \rightarrow U(1),$$

where the set underlying $U(1)$ is regarded as a groupoid with only identity morphisms. Hence the fact that $\exp(iS(-))$ has to send every morphism on the left to a morphism on the right is the gauge invariance of the action.

Furthermore, the action functional has the property of being *smooth*. It takes any *smooth family* of gauge fields, over some parameter space U , to a corresponding smooth family of elements of $U(1)$ and such that these assignments are compatible with precomposition of smooth functions $U_1 \rightarrow U_2$ between parameter spaces. The formal language that expresses this concept is that of *stacks on the site of smooth manifolds* (discussed in detail in 4.4 below): to say that for every U there is a groupoid, as above, of smooth U -families of gauge fields and smooth U -families of gauge transformations between them, in a consistent way, is to say that there is a *smooth moduli stack*, denoted $[\Sigma_3, \mathbf{BG}_{\text{conn}}]$, of gauge fields on Σ_3 . Finally, the fact that the Chern-Simons action functional is not only gauge invariant but also smooth is the fact that it refines to a morphism of smooth stacks

$$\exp(i\mathbf{S}(-)) : [\Sigma_3, \mathbf{BG}_{\text{conn}}] \rightarrow U(1),$$

where now $U(1)$ is regarded as a smooth stack by declaring that a smooth family of elements is a smooth function with values in $U(1)$.

It is useful to think of a smooth stack simply as being a *smooth groupoid*. Lie groups and Lie groupoids are examples (and are called “differentiable stacks” when regarded as special cases of smooth stacks) but there are important smooth groupoids which are not Lie groupoids in that they have not a smooth *manifold* but a more general smooth space of objects and of morphisms. Just as Lie groups have an infinitesimal approximation given by Lie algebras, so smooth stacks/smooth groupoids have an infinitesimal approximation given by *Lie algebroids*. The smooth moduli stack $[\Sigma_3, \mathbf{BG}_{\text{conn}}]$ of gauge field configuration on Σ_3 is best known in the physics literature in the guise of its underlying Lie algebroid: this is the formal dual of the (off-shell) *BRST complex* of the G -gauge theory on Σ_3 : in degree 0 this consists of the functions on the space of gauge fields on Σ_3 , and in degree 1 it consists of functions on infinitesimal gauge transformations between these: the “ghost fields”.

The smooth structure on the action functional is of course crucial in field theory: in particular it allows one to define the *differential* $d\exp(i\mathbf{S}(-))$ of the action functional and hence its critical locus, characterized by the Euler-Lagrange equations of motion. This is the *phase space* of the theory, which is a substack

$$[\Sigma_2, \mathfrak{b}\mathbf{BG}] \hookrightarrow [\Sigma_2, \mathbf{BG}_{\text{conn}}]$$

equipped with a pre-symplectic 2-form. To formalize this, write $\Omega_{\text{cl}}^2(-)$ for the smooth stack of closed 2-forms (without gauge transformations), hence the rule that sends a parameter manifold U to the set $\Omega_{\text{cl}}^2(U)$ of smooth closed 2-forms on U . This may be regarded as the *smooth moduli 0-stack* of closed 2-forms in that for every smooth manifold X the set of morphisms $X \rightarrow \Omega_{\text{cl}}^2(-)$ is in natural bijection to the set $\Omega_{\text{cl}}^2(X)$ of closed 2-forms on X . This is an instance of the *Yoneda lemma*. Similarly, a smooth 2-form on the moduli stack of field configurations is a morphism of smooth stacks of the form

$$[\Sigma_2, \mathbf{BG}_{\text{conn}}] \rightarrow \Omega_{\text{cl}}^2(-).$$

Explicitly, for Chern-Simons theory this morphism sends for each smooth parameter space U a given smooth U -family of gauge fields $A \in \Omega^1(\Sigma_2 \times U, \mathfrak{g})$ to the 2-form

$$\int_{\Sigma_2} \langle d_U A \wedge d_U A \rangle \in \Omega_{\text{cl}}^2(U).$$

Notice that if we restrict to *genuine* families A which are functions of U but vanish on vectors tangent to U (technically these are elements in the *concretification* of the moduli stack) then this 2-form is the *fiber*

integral of the Poincaré 2-form $\langle F_A \wedge F_A \rangle$ along the projection $\Sigma_2 \times U \rightarrow U$, where $F_A := dA + \frac{1}{2}[A \wedge A]$ is the curvature 2-form of A . This is the first sign of a general pattern, which we highlight in a moment.

There is more fundamental smooth moduli stack equipped with a closed 2-form: the moduli stack $\mathbf{BU}(1)_{\text{conn}}$ of $U(1)$ -gauge fields, hence of smooth circle bundles with connection. This is the rule that sends a smooth parameter manifold U to the groupoid $\mathbf{H}(U, \mathbf{BU}(1)_{\text{conn}})$ of $U(1)$ -gauge fields ∇ on U , which we have already seen above. Since the curvature 2-form $F_\nabla \in \Omega_{\text{cl}}^2(U)$ of a $U(1)$ -principal connection is gauge invariant, the assignment $\nabla \mapsto F_\nabla$ gives rise to a morphism of smooth stacks of the form

$$F_{(-)} : \mathbf{BU}(1)_{\text{conn}} \rightarrow \Omega_{\text{cl}}^2(-) .$$

In terms of this morphism the fact that every $U(1)$ -gauge field ∇ on some space X has an underlying field strength 2-form ω is expressed by the existence of a commuting diagram of smooth stacks of the form

$$\begin{array}{ccc} & \mathbf{BU}(1)_{\text{conn}} & \text{gauge field / differential cocycle} \\ & \nearrow \nabla & \downarrow F_{(-)} \\ X & \xrightarrow{\omega} & \Omega_{\text{cl}}^2(-) \\ & & \text{field strength / curvature .} \end{array}$$

Conversely, if we regard the bottom morphism ω as given, and regard this closed 2-form as a (pre)symplectic form, then a *choice of lift* ∇ in this diagram is a choice of refinement of the 2-form by a circle bundle with connection, hence the choice of a *prequantum circle bundle* in the language of geometric quantization (see for instance section II in [Bry00] for a review of geometric quantization).

Applied to the case of Chern-Simons theory this means that a smooth (off-shell) prequantization of the theory is a choice of dashed morphism in a diagram of smooth stacks of the form

$$\begin{array}{ccc} & \mathbf{BU}(1)_{\text{conn}} & \\ & \dashrightarrow & \downarrow F_{(-)} \\ [\Sigma_2, \mathbf{BG}_{\text{conn}}] & \xrightarrow{\int_{\Sigma_2} \langle F_{(-)}, F_{(-)} \rangle} & \Omega_{\text{cl}}^2(-) . \end{array}$$

Similar statements apply to on-shell geometric (pre)quantization of Chern-Simons theory, which has been so successfully applied in the original article [Wi89]. In summary, this means that in the context of smooth stacks the Chern-Simons action functional and its prequantization are as in the following table:

dimension		moduli stack description
$k = 3$	action functional (0-bundle)	$\exp(i\mathbf{S}(-)) : [\Sigma_3, \mathbf{BG}_{\text{conn}}] \rightarrow U(1)$
$k = 2$	prequantum circle 1-bundle	$[\Sigma_2, \mathbf{BG}_{\text{conn}}] \rightarrow \mathbf{BU}(1)_{\text{conn}}$

There is a precise sense, discussed in section 4.4.16 below, in which a $U(1)$ -valued function is a *circle k -bundle with connection* for $k = 0$. If we furthermore regard an ordinary $U(1)$ -principal bundle as a *circle 1-bundle* then this table says that in dimension k Chern-Simons theory appears as a *circle $(3 - k)$ -bundle with connection* – at least for $k = 3$ and $k = 2$.

Formulated this way, it should remind one of what is called *extended* or *multi-tiered* topological quantum field theory (formalized and classified in [L-TFT]) which is the full formalization of *locality* in the Schrödinger picture of quantum field theory. This says that *after quantization*, an n -dimensional topological field theory should be a rule that to a closed manifold of dimension k assigns an $(n - k)$ -categorical analog of a vector space of quantum states. Since ordinary geometric quantization of Chern-Simons theory assigns to a closed Σ_2 the vector space of *polarized sections* (holomorphic sections) of the line bundle associated to the above circle 1-bundle, this suggests that there should be an *extended* or *multi-tiered* refinement of geometric

(pre)quantization of Chern-Simons theory, which to a closed oriented manifold of dimension $0 \leq k \leq n$ assigns a *prequantum circle* $(n-k)$ -bundle (bundle $(n-k-1)$ -gerbe) on the moduli stack of field configurations over Σ_k , modulated by a morphism $[\Sigma_k, \mathbf{B}G_{\text{conn}}] \rightarrow \mathbf{B}^{(n-k)}U(1)_{\text{conn}}$ to a moduli $(n-k)$ -stack of circle $(n-k)$ -bundles with connection.

In particular for $k=0$ and Σ_0 connected, hence $\Sigma_0 = *$ the point, we have that the moduli stack of fields on Σ_0 is the *universal* moduli stack itself, $[*, \mathbf{B}G_{\text{conn}}] \simeq \mathbf{B}G_{\text{conn}}$, and so a *fully extended prequantization* of 3-dimensional G -Chern-Simons theory would have to involve a *universal characteristic* morphism

$$\mathbf{c}_{\text{conn}} : \mathbf{B}G_{\text{conn}} \rightarrow \mathbf{B}^3U(1)_{\text{conn}}$$

of smooth moduli stacks, hence a smooth circle 3-bundle with connection on the universal moduli stack of G -gauge fields. This indeed naturally exists: an explicit construction is given in [FSS10]. This morphism of smooth higher stacks is a differential refinement of a smooth refinement of the level itself: forgetting the connections and only remembering the underlying (higher) gauge bundles, we still have a morphism of smooth higher stacks

$$\mathbf{c} : \mathbf{B}G \rightarrow \mathbf{B}^3U(1).$$

This expression should remind one of the continuous map of topological spaces

$$c : BG \rightarrow B^3U(1) \simeq K(\mathbb{Z}, 4)$$

from the classifying space BG to the Eilenberg-MacLane space $K(\mathbb{Z}, 4)$, which represents the level as a class in integral cohomology $H^4(BG, \mathbb{Z}) \simeq \mathbb{Z}$. Indeed, there is a canonical *derived functor* or ∞ -*functor*

$$|-| : \mathbf{H} \rightarrow \text{Top}$$

from smooth higher stacks to topological spaces (one of the defining properties of a cohesive ∞ -topos), derived left adjoint to the operation of forming *locally constant higher stacks*, and under this map we have

$$|\mathbf{c}| \simeq c.$$

In this sense \mathbf{c} is a *smooth refinement* of $[c] \in H^4(BG, \mathbb{Z})$ and then \mathbf{c}_{conn} is a further *differential refinement* of \mathbf{c} .

However, more is true. Not only is there an extension of the prequantization of 3d G -Chern-Simons theory to the point, but this also induces the extended prequantization in every other dimension by *tracing*: for $0 \leq k \leq n$ and Σ_k a closed and oriented smooth manifold, there is a canonical morphism of smooth higher stacks of the form

$$\exp(2\pi i \int_{\Sigma_k} (-)) : [\Sigma_k, \mathbf{B}^nU(1)_{\text{conn}}] \rightarrow \mathbf{B}^{n-k}U(1)_{\text{conn}},$$

which refines the fiber integration of differential forms, that we have seen above, from curvature $(n+1)$ -forms to their entire prequantum circle n -bundles (we discuss this below in section 5.5.1.1). Since, furthermore, the formation of mapping stacks $[\Sigma_k, -]$ is functorial, this means that from a morphism \mathbf{c}_{conn} as above we get for every Σ_k a composite morphism as such:

$$\exp(2\pi i \int_{\Sigma_k} [-, \mathbf{c}_{\text{conn}}]) : [\Sigma_k, \mathbf{B}G_{\text{conn}}] \xrightarrow{[\Sigma_k, \mathbf{c}_{\text{conn}}]} [\Sigma_k, \mathbf{B}^nU(1)_{\text{conn}}] \xrightarrow{\exp(2\pi i \int_{\Sigma_k} (-))} \mathbf{B}^{n-k}U(1)_{\text{conn}}.$$

For 3d G -Chern-Simons theory and $k=n=3$ this composite *is* the action functional of the theory (down on the set $H(\Sigma_3, \mathbf{B}G_{\text{conn}})$ this is effectively the perspective on ordinary Chern-Simons theory amplified in [CJMSW05]). Therefore, for general k we may speak of this as the *extended action functional*, with values not in $U(1)$ but in $\mathbf{B}^{n-k}U(1)_{\text{conn}}$.

This way we find that the above table, containing the Chern-Simons action functional together with its prequantum circle 1-bundle, extends to the following table that reaches all the way from dimension 3 down to dimension 0.

dim.		prequantum $(3 - k)$ -bundle	
$k = 0$	differential fractional first Pontrjagin	$\mathbf{c}_{\text{conn}} : \mathbf{B}G_{\text{conn}} \rightarrow \mathbf{B}^3U(1)_{\text{conn}}$	[FSS10]
$k = 1$	WZW background B-field	$[S^1, \mathbf{B}G_{\text{conn}}] \xrightarrow{[S^1, \mathbf{c}_{\text{conn}}]} [S^1, \mathbf{B}^3U(1)_{\text{conn}}] \xrightarrow{\exp(2\pi i \int_{S^1} (-))} \mathbf{B}^2U(1)_{\text{conn}}$	
$k = 2$	off-shell CS prequantum bundle	$[\Sigma_2, \mathbf{B}G_{\text{conn}}] \xrightarrow{[\Sigma_2, \mathbf{c}_{\text{conn}}]} [\Sigma_2, \mathbf{B}^3U(1)_{\text{conn}}] \xrightarrow{\exp(2\pi i \int_{\Sigma_2} (-))} \mathbf{B}U(1)_{\text{conn}}$	
$k = 3$	3d CS action functional	$[\Sigma_3, \mathbf{B}G_{\text{conn}}] \xrightarrow{[\Sigma_3, \mathbf{c}_{\text{conn}}]} [\Sigma_3, \mathbf{B}^3U(1)_{\text{conn}}] \xrightarrow{\exp(2\pi i \int_{\Sigma_3} (-))} U(1)$	[FSS10]

For each entry of this table one may compute the *total space* object of the corresponding prequantum k -bundle. This is now in general itself a higher moduli stack. In full codimension $k = 0$ one finds that this is the moduli 2-stack of String(G)-2-connections described in [SSS09c, FSS12b]. This we discuss in section 5.5.5.1 below.

It is clear now that this is just the first example of a general class of theories which we may call *higher extended prequantum Chern-Simons theories* or just ∞ -Chern-Simons theories, for short. These are defined by a choice of

1. a smooth higher group G ;
2. a smooth universal characteristic map $\mathbf{c} : \mathbf{B}G \rightarrow \mathbf{B}^nU(1)$;
3. a differential refinement $\mathbf{c}_{\text{conn}} : \mathbf{B}G_{\text{conn}} \rightarrow \mathbf{B}^nU(1)_{\text{conn}}$.

An example of a 7-dimensional such theory on String-2-form gauge fields is discussed in [FSS12a], given by a differential refinement of the second fractional Pontrjagin class to a morphism of smooth moduli 7-stacks

$$\frac{1}{6}(\mathbf{p}_2)_{\text{conn}} : \mathbf{B}\text{String}_{\text{conn}} \rightarrow \mathbf{B}^7U(1)_{\text{conn}} .$$

We expect that these ∞ -Chern-Simons theories are part of a general procedure of *extended geometric quantization* (*multi-tiered* geometric quantization) which proceeds in two steps, as indicated in the following table.

classical system	geometric prequantization	quantization
char. class c of deg. $(n + 1)$ with de Rham image ω : invariant polynomial/ n -plectic form	prequantum circle n -bundle on moduli ∞ -stack of fields $\mathbf{c}_{\text{conn}} : \mathbf{B}G_{\text{conn}} \rightarrow \mathbf{B}^nU(1)_{\text{conn}}$	extended quantum field theory $Z_c : \Sigma_k \mapsto \left\{ \begin{array}{l} \text{polarized sections of} \\ \text{prequantum } (n - k)\text{-bundle} \\ \exp(2\pi i \int_{\Sigma_k} [\Sigma_k, \mathbf{c}_{\text{conn}}]) \end{array} \right\}$

Here we are concerned with the first step, the discussion of n -dimensional Chern-Simons gauge theories (higher gauge theories) in their incarnation as prequantum circle n -bundles on their universal moduli ∞ -stack of fields. A dedicated discussion of higher geometric prequantization, including the discussion of higher Heisenberg groups, higher quantomorphism groups, higher symplectomorphisms and higher Hamiltonian vector fields, and their action on higher prequantum spaces of states by higher Heisenberg operators, is given below. As shown there, plenty of interesting physical information turns out to be captured by extended prequantum n -bundles. For instance, if one regards the B-field in type II superstring backgrounds as a prequantum 2-bundle, then its extended prequantization knows all about twisted Chan-Paton bundles, the

Freed-Witten anomaly cancellation condition for type II superstrings on D-branes and the associated anomaly line bundle on the string configuration space.

Generally, all higher Chern-Simons theories that arise from extended action functionals this way enjoy a collection of very good formal properties. Effectively, they may be understood as constituting examples of a fairly extensive generalization of the *refined* Chern-Weil homomorphism with coefficients in *secondary characteristic cocycles*. Moreover, we have shown previously that the class of theories arising this way is large and contains not only several familiar theories, some of which are not traditionally recognized to be of this good form, but also contains various new QFTs that turn out to be of interest within known contexts, e.g. [FSS12b, FSS12b]. Here we further enlarge the pool of such examples.

Notably, here we are concerned with examples arising from *cup product* characteristic classes, hence of ∞ -Chern-Simons theories which are decomposable or non-primitive secondary characteristic cocycles, obtained by cup-ing more elementary characteristic cocycles. The most familiar example of these is again ordinary 3-dimensional Chern-Simons theory, but now for the non-simply connected gauge group $U(1)$. In this case a gauge field configuration in $\mathbf{H}(\Sigma_3, \mathbf{BU}(1)_{\text{conn}})$ is not necessarily given by a globally defined 1-form $A \in \Omega^1(\Sigma_3)$, instead it may have a non-vanishing “instanton number”, the Chern-class of the underlying circle bundle. Only if that happens to vanish is the value of the action functional again given by the simple expression $\exp(2\pi i k \int_{\Sigma_3} A \wedge d_{\text{dR}} A)$ as before. But in view of the above we are naturally led to ask: which circle 3-bundle (bundle 2-gerbe) with connection over Σ_3 , depending naturally on the $U(1)$ -gauge field, has $A \wedge d_{\text{dR}} A$ as its connection 3-form in this special case, so that the correct action functional in generality is again the *volume holonomy* of this 3-bundle (see section 5.5.3 below)? The answer is that it is the *differential cup square* of the gauge field with itself. As a fully extended action functional this is a natural morphism of higher moduli stacks of the form

$$(-)^{\cup^2_{\text{conn}}} : \mathbf{BU}(1)_{\text{conn}} \rightarrow \mathbf{B}^3 U(1)_{\text{conn}} .$$

This morphism of higher stacks is characterized by the fact that under forgetting the differential refinement and then taking geometric realization as before, it is exhibited as a differential refinement of the ordinary cup square on Eilenberg-MacLane spaces

$$(-)^{\cup^2} : K(\mathbb{Z}, 2) \rightarrow K(\mathbb{Z}, 4)$$

and hence on ordinary integral cohomology. By the above general procedure, we obtain a well-defined action functional for $3d$ $U(1)$ -Chern-Simons theory by the expression

$$\exp(2\pi i \int_{\Sigma_3} [\Sigma_3, (-)^{\cup^2_{\text{conn}}}] : [\Sigma_3, \mathbf{BU}(1)_{\text{conn}}] \rightarrow U(1)$$

and this is indeed the action functional of the familiar $3d$ $U(1)$ -Chern-Simons theory, also on non-trivial instanton sectors, see section 5.5.5.2 below.

In terms of this general construction, there is nothing particular to the low degrees here, and we have generally a differential cup square / extended action functional for a $(4k + 3)$ -dimensional Chern-Simons theory

$$(-)^{\cup^2_{\text{conn}}} : \mathbf{B}^{2k+1} U(1)_{\text{conn}} \rightarrow \mathbf{B}^{4k+3} U(1)_{\text{conn}}$$

for all $k \in \mathbb{N}$, which induces an ordinary action functional

$$\exp(2\pi i \int_{\Sigma_3} [\Sigma_{4k+3}, (-)^{\cup^2_{\text{conn}}}] : [\Sigma_{4k+3}, \mathbf{B}^{4k+3} U(1)_{\text{conn}}] \rightarrow U(1)$$

on the moduli $(2k + 1)$ -stack of $U(1)$ - $(2k + 1)$ -form gauge fields, given by the fiber integration on differential cocycles over the differential cup product of the fields. This is discussed in section 5.5.8.1 below.

Forgetting the smooth structure on $[\Sigma_{4k+3}, \mathbf{B}^{2k+1}U(1)_{\text{conn}}]$ and passing to gauge equivalence classes of fields yields the cohomology group $H_{\text{conn}}^{2k+2}(\Sigma_{4k+3})$. This is what is known as *ordinary differential cohomology* and is equivalent to the group of *Cheeger-Simons differential characters*, a review with further pointers is in [HoSi05]. That gauge equivalence classes of higher degree $U(1)$ -gauge fields are to be regarded as differential characters and that the $(4k+3)$ -dimensional $U(1)$ -Chern-Simons action functional on these is given by the fiber integration of the cup product is discussed in detail in [FP89], also mentioned notably in [Wi96, Wi98c] and expanded on in [Fr00]. Effectively this observation led to the general development of differential cohomology in [HoSi05]. Or rather, the main theorem there concerns a shifted version of the functional of $(4k+3)$ -dimensional $U(1)$ -Chern-Simons theory which allows one to further divide it by 2. We have discussed the refinement of this to smooth moduli stacks of fields in [FSS12b]. These developments were largely motivated from the relation of $(4k+3)$ -dimensional $U(1)$ -Chern-Simons theories as the holographic duals to theories of self-dual forms in dimension $(4k+2)$ (see [BeMo06] for survey and references): a choice of conformal structure on a Σ_{4k+2} naturally induces a polarization of the prequantum 1-bundle of the $(4k+3)$ -dimensional theory, and for every choice the resulting space of quantum states is naturally identified with the corresponding conformal blocks (correlators) of the $(4k+2)$ -dimensional theory.

Therefore we have that regarding the differential cup square on smooth higher moduli stacks as an extended action functional yields the following table of familiar notions under extended geometric prequantization.

dim.		prequantum $(4k+3-d)$ -bundle
$d=0$	differential cup square	$(-)\cup_{\text{conn}}^2 : \mathbf{B}^{2k+1}U(1)_{\text{conn}} \rightarrow \mathbf{B}^{4k+3}U(1)_{\text{conn}}$
\vdots	\vdots	\vdots
$d=4k+2$	“pre-conformal blocks” of self-dual $2k$ -form field	$[\Sigma_{4k+2}, \mathbf{B}^{2k+1}U(1)_{\text{conn}}] \xrightarrow{[\Sigma_{4k+2}, (-)\cup_{\text{conn}}^2]} [\Sigma_{4k+2}, \mathbf{B}^{2k+1}U(1)_{\text{conn}}] \xrightarrow{\exp(2\pi i \int_{\Sigma_{4k+2}} (-))} \mathbf{B}U(1)_{\text{conn}}$
$d=4k+3$	CS action functional	$[\Sigma_{4k+3}, \mathbf{B}^{2k+1}U(1)_{\text{conn}}] \xrightarrow{[\Sigma_{4k+3}, (-)\cup_{\text{conn}}^2]} [\Sigma_{4k+3}, \mathbf{B}^{2k+1}U(1)_{\text{conn}}] \xrightarrow{\exp(2\pi i \int_{\Sigma_{4k+3}} (-))} U(1)$

This fully extended prequantization of $(4k+3)$ -dimensional $U(1)$ -Chern-Simons theory allows for instance to ask for and compute the total space of the prequantum circle $(4k+3)$ -bundle. This is now itself a higher smooth moduli stack. For $k=0$, hence in $3d$ -Chern-Simons theory it turns out to be the moduli 2-stack of *differential T-duality structures*. This we discuss in section 5.5.5.2 below.

More generally, as the name suggests, the *differential cup square* is a specialization of a general *differential cup product*. As a morphism of bare homotopy types this is the familiar cup product of Eilenberg-MacLane spaces

$$(-)\cup(-) : K(\mathbb{Z}, p+1) \times K(\mathbb{Z}, q+1) \rightarrow K(\mathbb{Z}, p+q+2)$$

for all $p, q \in \mathbb{N}$. Its smooth and then its further differential refinement is a morphism of smooth higher stacks of the form

$$(-)\cup_{\text{conn}}(-) : \mathbf{B}^pU(1)_{\text{conn}} \times \mathbf{B}^qU(1)_{\text{conn}} \rightarrow \mathbf{B}^{p+q+1}U(1)_{\text{conn}}.$$

By the above discussion this now defines a higher extended gauge theory in dimension $p+q+1$ of *two different* species of higher $U(1)$ -gauge fields. One example of this is the *higher electric-magnetic coupling anomaly* in higher (Euclidean) $U(1)$ -Yang-Mills theory, as explained in section 2 of [Fr00]. In this example one considers on an oriented smooth manifold X (here assumed to be closed, for simplicity) an *electric current* $(p+1)$ -form $J_{\text{el}} \in \Omega_{\text{cl}}^{p+1}(X)$ and a *magnetic current* $(q+1)$ -form $J_{\text{mag}} \in \Omega_{\text{cl}}^{q+1}(X)$, such that $p+q = \dim(X)$ is the dimension of X . A *prequantization* of these current forms in our sense of higher geometric quantization

is a lift to differential cocycles

$$\begin{array}{ccc}
& \mathbf{B}^p U(1)_{\text{conn}} & \\
& \nearrow \hat{J}_{\text{el}} & \downarrow F_{(-)} \\
X & \xrightarrow{J_{\text{el}}} & \Omega_{\text{cl}}^{p+1}(-) ,
\end{array}
\qquad
\begin{array}{ccc}
& \mathbf{B}^q U(1)_{\text{conn}} & \\
& \nearrow \hat{J}_{\text{mag}} & \downarrow F_{(-)} \\
X & \xrightarrow{J_{\text{mag}}} & \Omega_{\text{cl}}^{q+1}(-)
\end{array}$$

and here this amounts to electric and magnetic *charge quantization*, respectively: the electric charge is the universal integral cohomology class of the circle p -bundle underlying the electric charge cocycle: its *higher Dixmier-Douady class* $[\hat{J}_{\text{el}}] \in H_{\text{cpt}}^{p+1}(X, \mathbb{Z})$ (see section 5.5.3 below); and similarly for the magnetic charge. Accordingly, the higher mapping stack $[X, \mathbf{B}^p U(1)_{\text{conn}} \times \mathbf{B}^q U(1)_{\text{conn}}]$ is the smooth higher moduli stack of charge-quantized electric and magnetic currents on X . Recall that this assigns to a smooth test manifold U the higher groupoid whose objects are U -families of pairs of charge-quantized electric and magnetic currents, namely such currents on $X \times U$. As [Fr00] explains in terms of such families of fields, the $U(1)$ -principal bundle with connection that in the present formulation is the one modulated by the morphism

$$\nabla_{\text{an}} := \exp(2\pi i \int_X [X, (-) \cup_{\text{conn}} (-)]) : [X, \mathbf{B}^p U(1)_{\text{conn}} \times \mathbf{B}^q U(1)_{\text{conn}}] \rightarrow \mathbf{B}U(1)_{\text{conn}}$$

is the *anomaly line bundle* of $(p-1)$ -form electromagnetism on X , in the presence of electric and magnetic currents subject to charge quantization. In the language of ∞ -Chern-Simons theory as above, this is equivalently the off-shell prequantum 1-bundle of the higher cup product Chern-Simons theories on pairs of $U(1)$ -gauge p -form and q -form fields.

Regarded as an anomaly bundle, one calls its curvature the *local anomaly* and its *holonomy* the “global anomaly”. In our context the holonomy of ∇_{an} is (discussed again in section 5.5.3 below) the morphism

$$\text{hol}(\nabla_{\text{an}}) = \exp(2\pi i \int_{S^1} [S^1, \nabla_{\text{an}}]) : [S^1, [X, \mathbf{B}^p U(1)_{\text{conn}} \times \mathbf{B}^q U(1)_{\text{conn}}] \rightarrow U(1)$$

from the loop space of the moduli stack of fields to $U(1)$. By the characteristic universal property of higher mapping stacks, together with the “Fubini-theorem”-property of fiber integration, this is equivalently the morphism

$$\exp(2\pi i \int_{X \times S^1} [X \times S^1, (-) \cup_{\text{conn}} (-)]) : [X \times S^1, \mathbf{B}^p U(1)_{\text{conn}} \times \mathbf{B}^q U(1)_{\text{conn}}] \rightarrow U(1).$$

But from the point of view of ∞ -Chern-Simons theory this is the *action functional* of the higher cup product Chern-Simons field theory induced by \cup_{conn} . The situation is now summarized in the following table.

dim.		prequantum $(\dim(X) + 1 - k)$ -bundle
$k = 0$	differential cup product	$(-)^{\cup_{\text{conn}}} : \mathbf{B}^p U(1)_{\text{conn}} \mathbf{B}^q U(1)_{\text{conn}} \rightarrow \mathbf{B}^{d+2} U(1)_{\text{conn}}$
\vdots	\vdots	\vdots
$k = \dim(X)$	higher E/M-charge anomaly line bundle	$\exp(2\pi i \int_X [X, (-) \cup_{\text{conn}} (-)]) : [X, \mathbf{B}^p U(1)_{\text{conn}} \times \mathbf{B}^q U(1)_{\text{conn}}] \longrightarrow \mathbf{B}U(1)_{\text{conn}}$
$k = \dim(X) + 1$	global anomaly	$\exp(2\pi i \int_{X \times S^1} [X \times S^1, (-) \cup_{\text{conn}} (-)]) : [X \times S^1, \mathbf{B}^p U(1)_{\text{conn}} \times \mathbf{B}^q U(1)_{\text{conn}}] \rightarrow U(1)$

These higher electric-magnetic anomaly Chern-Simons theories are of particular interest when the higher electric/magnetic currents are themselves induced by other gauge fields. Namely if we have any two ∞ -Chern-Simons theories given by extended action functionals $\mathbf{c}_{\text{conn}}^1 : \mathbf{B}G_{\text{conn}}^1 \rightarrow \mathbf{B}^p U(1)_{\text{conn}}$ and $\mathbf{c}_{\text{conn}}^2 : \mathbf{B}G_{\text{conn}}^2 \rightarrow \mathbf{B}^q U(1)_{\text{conn}}$, respectively, then composition of these with the differential cup product yields an extended action functional of the form

$$\mathbf{c}_{\text{conn}}^1 \cup_{\text{conn}} \mathbf{c}_{\text{conn}}^2 : \mathbf{B}(G^1 \times G^2)_{\text{conn}} \xrightarrow{(\mathbf{c}_{\text{conn}}^1, \mathbf{c}_{\text{conn}}^2)} \mathbf{B}^p U(1)_{\text{conn}} \times \mathbf{B}^q U(1)_{\text{conn}} \xrightarrow{(-) \cup_{\text{conn}} (-)} \mathbf{B}^{p+q+1} U(1)_{\text{conn}} ,$$

which describes extended topological field theories in dimension $p + q + 1$ on two species of (possibly non-abelian, possibly higher) gauge fields, or equivalently describes the higher electric/magnetic anomaly for higher electric fields induced by \mathbf{c}^1 and higher magnetic fields induced by \mathbf{c}^2 .

For instance for heterotic string backgrounds $\mathbf{c}_{\text{conn}}^2$ is the differential refinement of the first fractional Pontrjagin class $\frac{1}{2}p_1 \in H^4(B\text{Spin}, \mathbb{Z})$ [SSS09c, FSS10] of the form

$$\mathbf{c}_{\text{conn}}^2 = \widehat{J}_{\text{mag}}^{\text{NS5}} = \frac{1}{2}(\mathbf{p}_1)_{\text{conn}} : \mathbf{B}\text{Spin}_{\text{conn}} \rightarrow \mathbf{B}^3U(1)_{\text{conn}},$$

formalizing the *magnetic NS5-brane charge* needed to cancel the fermionic anomaly of the heterotic string by way of the Green-Schwarz mechanism. It is curious to observe, going back to the very first example of this introduction, that this $\widehat{J}_{\text{mag}}^{\text{NS5}}$ is at the same time the extended action functional for 3d Spin-Chern-Simons theory.

Still more generally, we may differentially cup in this way more than two factors. Examples for such *higher order cup product theories* appear in 11-dimensional supergravity. Notably plain classical 11d supergravity contains an 11-dimensional cubic Chern-Simons term whose extended action functional in our sense is

$$(-)^{\cup_{\text{conn}}^3} : \mathbf{B}^3U(1)_{\text{conn}} \rightarrow \mathbf{B}^{11}U(1)_{\text{conn}}.$$

Here for X the 11-dimensional spacetime, a field in $[X, \mathbf{B}^3U(1)]$ is a first approximation to a model for the *supergravity C-field*. If the differential cocycle happens to be given by a globally defined 3-form C , then the induced action functional $\exp(2\pi i \int_X [X, (-)^{\cup_{\text{conn}}^3}])$ sends this to element in $U(1)$ given by the familiar expression

$$\exp(2\pi i \int_X [X, (-)^{\cup_{\text{conn}}^3}]) : C \mapsto \exp(2\pi i \int_X C \wedge d_{\text{dR}}C \wedge d_{\text{dR}}C).$$

More precisely this model receives quantum corrections from an 11-dimensional Green-Schwarz mechanism. In [FSS12b, FSS12b] we have discussed in detail relevant corrections to the above extended cubic cup-product action functional on the moduli stack of flux-quantized C -field configurations.

Boundaries and long fiber sequences of characteristic classes It is a traditionally familiar fact that short exact sequences of (discrete) groups give rise to long sequences in cohomology with coefficients in these groups. In fact, before passing to cohomology, these long exact sequences are refined by corresponding long fiber sequences of the homotopy types obtained by the higher delooping of these groups: of the higher classifying spaces of these groups.

An example for which these long fiber sequences are of interest in the context of quantum field theory is the universal first fractional Pontryagin class $\frac{1}{2}p_1$ on the classifying space of Spin-principal bundles. The following digram displays the first steps in the long fiber sequence that it induces, together with an actual Spin-principal bundle $P \rightarrow X$ classified by a map $X \rightarrow B\text{Spin}$. All squares are homotopy pullback squares

of bare homotopy types.

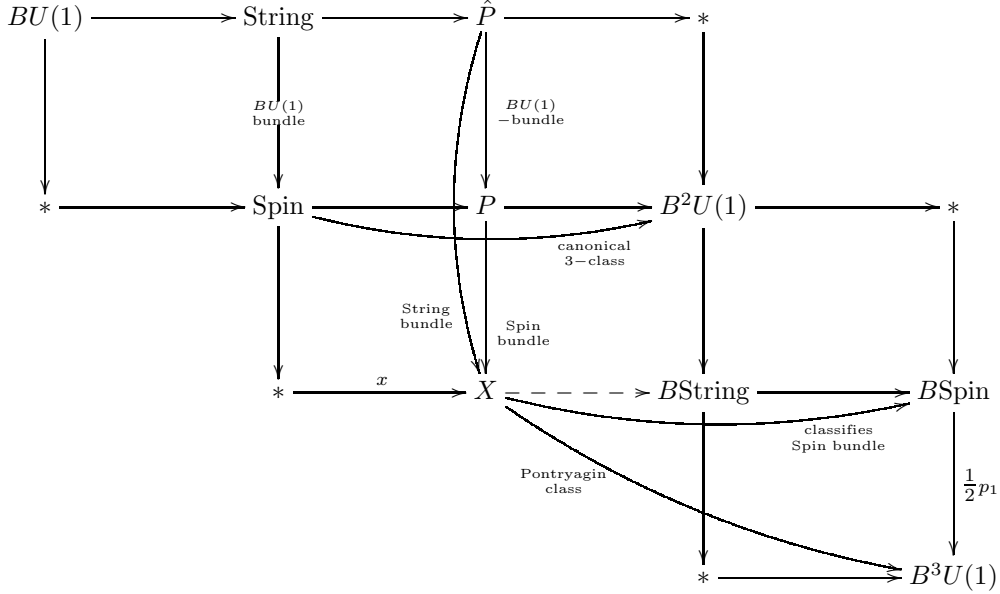

The topological group String which appears here as the loop space object of the homotopy fiber of $\frac{1}{2}p_1$ is the *String group*. We discuss this in detail below in 5.1. It is a $BU(1)$ -extension of the Spin -group.

If X happens to be equipped with the structure of a smooth manifold, then it is natural to also equip the Spin -principal bundle $P \rightarrow X$ with the structure of a smooth bundle, and hence to lift the classifying map $X \rightarrow B\text{Spin}$ to a morphism $X \rightarrow \mathbf{BSpin}$ into the *smooth moduli stack* of smooth Spin -principal bundles (the morphism that not just classifies but “modulates” $P \rightarrow X$ as a smooth structure). An evident question then is: can the rest of the diagram be similarly lifted to a smooth context?

This indeed turns out to be the case, if we work in the context of *higher* smooth stacks. For instance there is a smooth moduli 3-stack $\mathbf{B}^2U(1)$ such that a morphism $\text{Spin} \rightarrow \mathbf{B}^2U(1)$ not just classifies a $BU(1)$ -bundle over Spin , but “modulates” a smooth *circle 2-bundle* or $U(1)$ -*bundle gerbe* over Spin . One then gets the following diagram

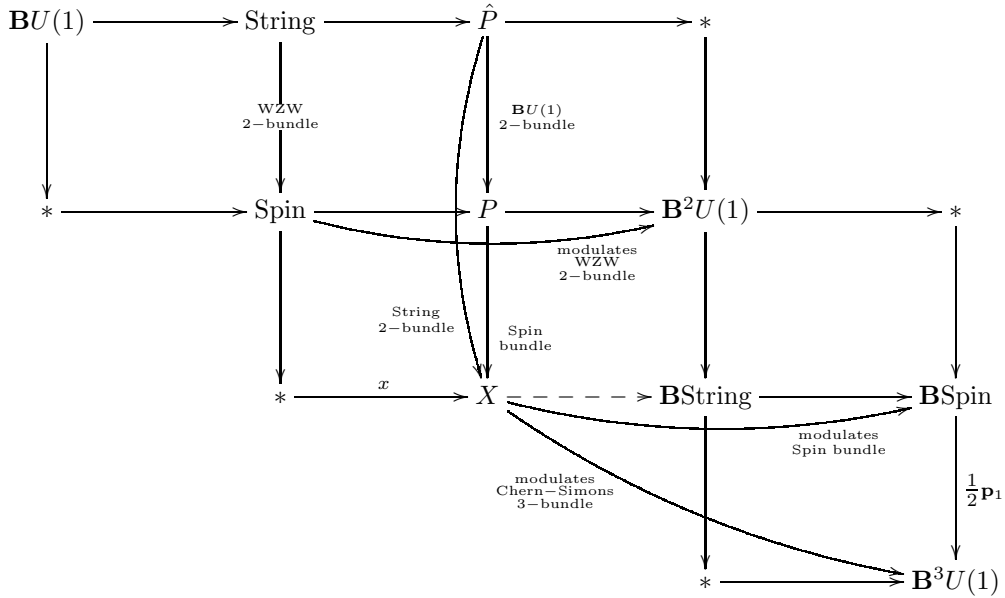

where now all squares are homotopy pullbacks of smooth higher stacks.

With this smooth geometric structure in hand, one can then go further and ask for *differential* refinements: the smooth Spin-principal bundle $P \rightarrow X$ might be equipped with a principal connection ∇ , and if so, this will be “modulated” by a morphism $X \rightarrow \mathbf{BSpin}_{\text{conn}}$ into the smooth moduli stack of Spin-connections.

One of our central theorems below in 5.1 is that the universal first fractional Pontryagin class can be lifted to this situation to a *differential smooth* universal morphism of higher moduli stacks, which we write $\frac{1}{2}\hat{\mathbf{P}}_1$. Inserting this into the above diagram and then forming homotopy pullbacks as before yields further differential refinements. It turns out that these now induce the Lagrangians of 3-dimensional Spin Chern-Simons theory and of the WZW theory on Spin.

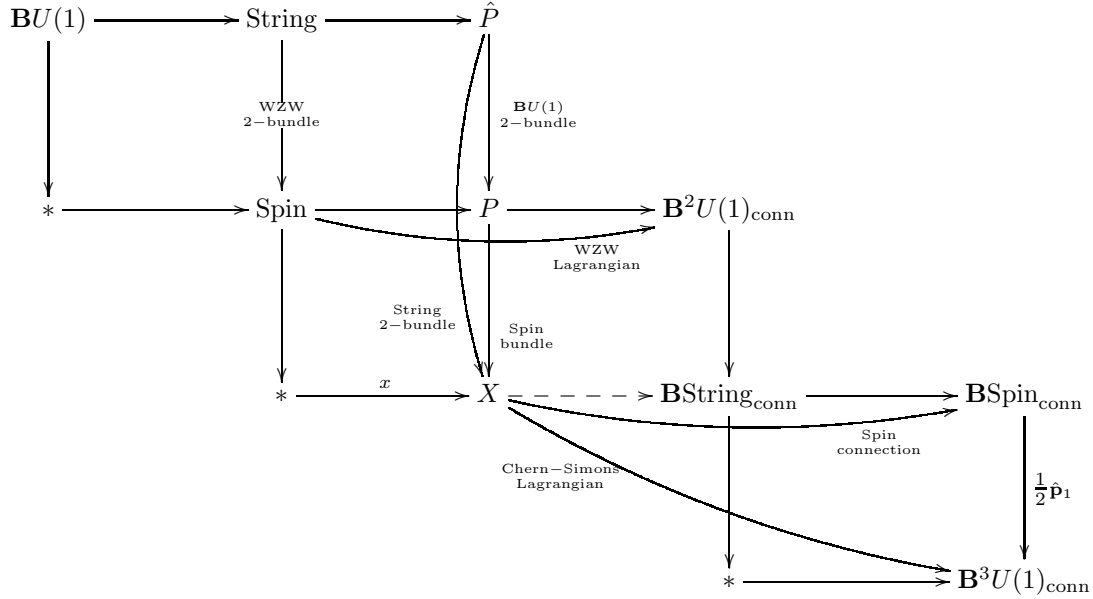

One way to understand our developments here is as a means to formalize and then analyze this setup and its variants and generalizations.

1.1.4 Philosophical motivation

Finally we offer a motivation for the development of physics in cohesive higher topos theory for readers who can appreciate philosophical considerations formalized in higher category theory. Other readers should kindly ignore this section.

In [Law91] Lawvere refers to cohesive toposes as *Categories of Being* and refers to the phenomenon exhibited by the adjunctions that define them as *Becoming*, thereby following the terminology of [He1841] and in effect proposing a formal interpretation of Hegel’s ontology in topos theory. The following might be regarded as further expanding on this line of thought.

The history of theoretical fundamental physics is the story of a search for the suitable mathematical notions and structural concepts that naturally model the physical phenomena in question. Examples include, roughly in historical order,

1. the identification of symplectic geometry as the underlying structure of classical Hamiltonian mechanics;
2. the identification of (semi-)Riemannian differential geometry as the underlying structure of gravity;
3. the identification of group and representation theory as the underlying structure of the zoo of fundamental particles;

4. the identification of Chern-Weil theory and differential cohomology as the underlying structure of gauge theories.

All these examples exhibit the identification of the precise mathematical language that naturally captures the physics under investigation. Modern theoretical insight in theoretical fundamental physics is literally *unthinkable* without these formulations.

Therefore it is natural to ask whether one can go further. Not only have we seen above in 1.1.2 that some of these formulations leave open questions that we would want them to answer. But one is also led to wonder if this list of mathematical theories cannot be subsumed into a single more fundamental system altogether.

In a philosophical vein we should ask

Where does physics take place, conceptually?

Such philosophical-sounding questions can be given useful formalizations in terms of category theory. In this context “place” translates to *topos*, “taking place” translates to *internalization* and whatever it is that takes places is characterized by a collection of *universal constructions* (categorical limits and colimits, categorical adjunctions).

So we translate

Physics takes place.

Certain universal constructions internalize in a suitable topos.

(For the following explanation of what precisely this means the reader only needs to know the concept of *adjoint functors*.)

The remaining question is

What characterizes a suitable topos and what are the universal constructions capturing physics.

At the bottom of it there are two aspects to physics, *kinematics* and *dynamics*. Roughly, kinematics is about the nature of *geometric spaces* appearing in physics, dynamics is about *trajectories* – paths – in these spaces. We will argue that

- the notion of a topos of geometric spaces is usefully given by what goes by the technical term *local topos*;
- the notion of a topos of spaces with trajectories is usefully given by what goes by the technical term *∞ -connected topos*.

A topos that is both local and ∞ -connected we call *cohesive*.

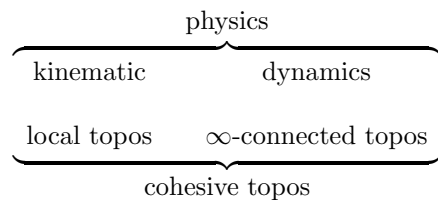

Kinematics – local toposes. With a notion of *bare* spaces given, a notion of geometric spaces comes with a forgetful functor $\text{GeometricSpaces} \rightarrow \text{BareSpaces}$ that forgets geometric structure. The claim is that two extra conditions on this functor guarantee that indeed the structure it forgets is some *geometric structure*.

- There is a category C of *local models* such that every geometric space is obtained by *gluing* of local models. The operation of gluing following a blueprint is left adjoint to the inclusion of geometric spaces into blueprints for geometric spaces.

- Every bare space can canonically be equipped with the two universal cases of geometric structure, *discrete* and *indiscrete* geometric structure. (For instance a set can be equipped with discrete topology or discrete smooth structure.)

Equipping with these structure is left and right adjoint, respectively, to forgetting geometric structure.

$$\begin{array}{ccc}
 & \xrightarrow{\text{glue local models}} & \\
 \text{BlueprintsOfGeometricSpaces} & \xleftrightarrow{\quad} & \text{GeometricSpaces} \xrightarrow{\text{form discrete geometric structure}} \text{BareSpaces} \\
 & \xleftarrow{\quad} & \xleftarrow{\text{forget geometric structure}} \\
 & & \xleftarrow{\text{form indiscrete geometric structure}}
 \end{array}$$

If we take a bare space to be a set of points, then this translates into the following formal statement.

$$\text{Func}(C^{\text{op}}, \text{Set}) \xleftrightarrow{\text{sheaffication}} \text{Sh}(C) \xleftrightarrow[\text{coDisc}]{\text{Disc}} \text{Set} \xleftrightarrow[\Gamma]{\quad} \text{Set}$$

The category of geometric spaces embeds into the category of contravariant functors on test spaces, and this embedding has a left adjoint. It is a basic fact of topos theory that such *reflective embeddings* are precisely categories of *sheaves* on C with respect to some Grothendieck topology on C (which is defined by the reflective embedding). Therefore the first demand above says that GeometricSpaces is to be what is called a *sheaf topos*.

Another basic fact of topos theory says that this already implies the first part of the second demand, and uniquely so. There is unique pair of adjoint functors $(\text{Disc} \dashv \Gamma)$ as indicated. The demand of the further right adjoint embedding coDisc is what makes the sheaf topos a *local topos*.

These and the following axioms are very simple. Nevertheless, by the power of category theory, it turns out that they have rich implications. But we will we show that for them to have implications *just rich enough* to indeed formalize the kind of structures mentioned at the beginning, we want to pass to ∞ -toposes instead. Then the above becomes

$$\infty\text{Func}(C^{\text{op}}, \infty\text{Grpd}) \xleftrightarrow{\infty\text{-stackification}} \text{Sh}_{\infty}(C) \xleftrightarrow[\text{coDisc}]{\text{Disc}} \infty\text{Grpd} \xleftrightarrow[\Gamma]{\quad} \infty\text{Grpd}$$

Dynamics – ∞ -connected toposes With a notion of *discrete ∞ -groupoids* inside geometric ∞ -groupoids given, we can ask for discrete ∞ -bundles over any X to be characterized by the *parallel transport* that takes their fibers into each other, as they move along paths in X . By the basic idea of *Galois theory* (see 3.8.6), this completely characterizes a notion of trajectory.

Formally this means that we require a further left adjoint $(\Pi \dashv \text{Disc})$.

$$\text{Geometric}\infty\text{Grpd}(X, \text{Disc}K) \simeq \infty\text{Grpd}(\Pi(X), K)$$

bundles of discrete ∞ -groupoids on X	parallel transport of discrete ∞ -groupoids along trajectories in X
--	---

This means that for any X we can think of $\Pi(X)$ as the ∞ -groupoid of paths in X , of paths-between-paths in X , and so on.

In order for this to yield a consistent notion of paths in the geometric context, we want to demand that there are no non-trivial paths in the point (the terminal object), hence that

$$\Pi(*) \simeq *$$

An ordinary topos for which Π exists and satisfies this property is called *locally connected and connected*. Hence an ∞ -topos for which Π exists and satisfies this extra condition we call *∞ -connected*. This terminology is good, but a bit subtle, since it refers to the meta-topology of the *collection of all geometric spaces* rather than to any that of any topological space itself. The reader is advised to regard it just as a technical term for the time being.

Physics – cohesive toposes An ∞ -topos that is both local as well as ∞ -connected we call *cohesive*. The idea is that the extra adjoints on it encode the information of how sets of cells in an ∞ -groupoid are geometrically held together, for instance in that there are smooth paths between them. In the models of cohesive ∞ -toposes that we will construct the local models are *open balls* with geometric structure and each such open ball can be thought of as a “cohesive blob of points”.

The axioms on a cohesive topos are simple and fully formal. They involve essentially just the notion of adjoint functors.

We can ask now for universal constructions such that internalized in any cohesive ∞ -topos they usefully model differential geometry, differential cohomology, action functionals for physical systems, etc. Below in 3.9 we give a comprehensive discussion of an extensive list of such structures. Here we highlight one them. Differential forms.

One consequence of the axioms of cohesion is that every *connected* object in a cohesive ∞ -topos \mathbf{H} has an essentially unique point (whereas in general it may fail to have a point). We have an equivalence

$$\infty\mathrm{Grp}(\mathbf{H}) \underset{\mathbf{B}}{\overset{\Omega}{\rightleftarrows}} \mathbf{H}_{*, \geq 1}$$

between group objects G in \mathbf{H} and (uniquely pointed) connected objects in \mathbf{H} .

Define now

$$(\mathbf{\Pi} \dashv \mathbf{b}) := (\mathrm{Disc}\mathbf{\Pi} \dashv \mathrm{Disc}\mathbf{\Gamma}).$$

The $(\mathrm{Disc} \dashv \mathbf{\Gamma})$ -counit gives a morphism

$$\mathbf{b}BG \rightarrow BG.$$

We write $\mathbf{b}_{\mathrm{dR}}BG$ for the ∞ -pullback

$$\begin{array}{ccc} \mathbf{b}_{\mathrm{dR}}BG & \longrightarrow & \mathbf{b}BG \\ \downarrow & & \downarrow \\ * & \longrightarrow & BG \end{array}.$$

We show in 4.4.13 that with this construction internalized in smooth ∞ -groupoids, the object $\mathbf{b}_{\mathrm{dR}}BG$ is the coefficient object for flat \mathfrak{g} -valued differential forms, where \mathfrak{g} is the ∞ -Lie algebra of G .

Moreover, there is a canonical such form on G itself. This is obtained by forming the pasting diagram of ∞ -pullbacks

$$\begin{array}{ccc} A & \longrightarrow & * \\ \downarrow \theta & & \downarrow \\ \mathbf{b}_{\mathrm{dR}}BG & \longrightarrow & \mathbf{b}BG \\ \downarrow & & \downarrow \\ * & \longrightarrow & BG \end{array}.$$

We show below in 4.4.15 that this theta is canonical (Maurer-Cartan) \mathfrak{g} -valued form on G . Then in 4.4.16 we show that for G a shifted abelian group, this form is the *universal curvature characteristic*. Flat parallel G -valued transport that is *twisted* by this form encodes non-flat ∞ -connections. Gauge fields and higher gauge fields are examples.

In 4.4.19 we show that, just as canonically, action functionals for these higher gauge fields exist in \mathbf{H} .

All this just from a system of adjoint ∞ -functors.

1.2 The geometry of physics

The following is an introduction to the higher differential geometric structures in the formulation of modern fundamental physics, in particular in pre-quantized classical mechanics, 1.2.10, higher pre-quantized local classical field theory, 1.2.11 and specifically for twisted and higher gauge fields, 1.2.12.

To some extent this is classical material, roughly along the lines of a textbook such as [Fra], but we present it from a modern perspective that serves to motivate and prepare for the more general abstract developments in section 3. More details on applications are in section 5.

This section has an online counterpart in [Sc13a] with more material and further pointers.

Geometry

- 1.2.1 – Coordinate systems
- 1.2.2 – Smooth 0-types
- 1.2.3 – Differential forms
- 1.2.4 – Smooth homotopy types
- 1.2.5 – Principal bundles
- 1.2.6 – Principal connections
- 1.2.7 – Characteristic classes
- 1.2.8 – Lie algebras
- 1.2.9 – Chern-Weil homomorphism

Physics

- 1.2.10 – Hamilton-Jacobi-Lagrange mechanics via Prequantized Hamiltonian correspondences
- 1.2.11 – Hamilton-de Donder-Weyl field theory via Higher correspondences
- 1.2.12 – Higher pre-quantum gauge fields
- 1.2.13 – Variational calculus on higher moduli stacks of fields
- 1.2.14 – Higher geometric pre-quantum theory
- 1.2.15 – Examples of higher prequantum field theories

1.2.1 Coordinate systems

Every kind of geometry is modeled on a collection of archetypical basic spaces and geometric homomorphisms between them. In differential geometry the archetypical spaces are the abstract standard Cartesian coordinate systems, denoted \mathbb{R}^n , in every dimension $n \in \mathbb{N}$, and the geometric homomorphism between them are smooth functions $\mathbb{R}^{n_1} \rightarrow \mathbb{R}^{n_2}$, hence smooth (and possibly degenerate) coordinate transformations.

Here we discuss the central aspects of the nature of such abstract coordinate systems in themselves. At this point these are not yet coordinate systems on some other space. That is instead the topic of the next section Smooth spaces.

1.2.1.1 The continuum real (world-)line The fundamental premise of differential geometry as a model of geometry in physics is the following.

Premise. *The abstract worldline of any particle is modeled by the continuum real line \mathbb{R} .*

This comes down to the following sequence of premises.

1. There is a linear ordering of the points on a worldline: in particular if we pick points at some intervals on the worldline we may label these in an order-preserving way by integers

$$\mathbb{Z}.$$

2. These intervals may each be subdivided into n smaller intervals, for each natural number n . Hence we may label points on the worldline in an order-preserving way by the rational numbers

$$\mathbb{Q}.$$

3. This labeling is dense: every point on the worldline is the supremum of an inhabited bounded subset of such labels. This means that a worldline is the *real line*, the continuum of real numbers

$$\mathbb{R}.$$

The adjective “real” in “real number” is a historical shadow of the old idea that real numbers are related to observed reality, hence to physics in this way. The experimental success of this assumption shows that it is valid at least to very good approximation.

Speculations are common that in a fully exact theory of quantum gravity, currently unavailable, this assumption needs to be refined. For instance in p-adic physics one explores the hypothesis that the relevant completion of the rational numbers as above is not the reals, but p-adic numbers \mathbb{Q}_p for some prime number $p \in \mathbb{N}$. Or for example in the study of QFT on non-commutative spacetime one explore the idea that at small scales the smooth continuum is to be replaced by an object in noncommutative geometry. Combining these two ideas leads to the notion of non-commutative analytic space as a potential model for space in physics. And so forth.

For the time being all this remains speculation and differential geometry based on the continuum real line remains the context of all fundamental model building in physics related to observed phenomenology. Often it is argued that these speculations are necessitated by the very nature of quantum theory applied to gravity. But, at least so far, such statements are not actually supported by the standard theory of quantization: we discuss below in Geometric quantization how not just classical physics but also quantum theory, in the best modern version available, is entirely rooted in differential geometry based on the continuum real line.

This is the motivation for studying models of physics in geometry modeled on the continuum real line. On the other hand, in all of what follows our discussion is set up such as to be maximally independent of this specific choice (this is what *topos theory* accomplishes for us). If we do desire to consider another choice of archetypical spaces for the geometry of physics we can simply “change the site”, as discussed below and many of the constructions, propositions and theorems in the following will continue to hold. This is notably what we do below in Supergeometric coordinate systems when we generalize the present discussion to a flavor of differential geometry that also formalizes the notion of fermion particles: “differential supergeometry”.

1.2.1.2 Cartesian spaces and smooth functions

Definition 1.2.1. A function of sets $f : \mathbb{R} \rightarrow \mathbb{R}$ is called a *smooth function* if, coinductively:

1. the derivative $\frac{df}{dx} : \mathbb{R} \rightarrow \mathbb{R}$ exists;
2. and is itself a smooth function.

Definition 1.2.2. For $n \in \mathbb{N}$, the *Cartesian space* \mathbb{R}^n is the set

$$\mathbb{R}^n = \{(x^1, \dots, x^n) \mid x^i \in \mathbb{R}\}$$

of n -tuples of real numbers. For $1 \leq k \leq n$ write

$$i^k : \mathbb{R} \rightarrow \mathbb{R}^n$$

for the function such that $i^k(x) = (0, \dots, 0, x, 0, \dots, 0)$ is the tuple whose k th entry is x and all whose other entries are $0 \in \mathbb{R}$; and write

$$p^k : \mathbb{R}^n \rightarrow \mathbb{R}$$

for the function such that $p^k(x^1, \dots, x^n) = x^k$.

A *homomorphism* of Cartesian spaces is a smooth function

$$f : \mathbb{R}^{n_1} \rightarrow \mathbb{R}^{n_2},$$

hence a function $f : \mathbb{R}^{n_1} \rightarrow \mathbb{R}^{n_2}$ such that all partial derivatives exist and are continuous.

Example 1.2.3. Regarding \mathbb{R}^n as an \mathbb{R} -vector space, every linear function $\mathbb{R}^{n_1} \rightarrow \mathbb{R}^{n_2}$ is in particular a smooth function.

Remark 1.2.4. But a homomorphism of Cartesian spaces in def. 1.2.2 is *not* required to be a linear map. We do *not* regard the Cartesian spaces here as vector spaces.

Definition 1.2.5. A smooth function $f : \mathbb{R}^{n_1} \rightarrow \mathbb{R}^{n_2}$ is called a *diffeomorphism* if there exists another smooth function $\mathbb{R}^{n_2} \rightarrow \mathbb{R}^{n_1}$ such that the underlying functions of sets are inverse to each other

$$f \circ g = \text{id}$$

and

$$g \circ f = \text{id}.$$

Proposition 1.2.6. *There exists a diffeomorphism $\mathbb{R}^{n_1} \rightarrow \mathbb{R}^{n_2}$ precisely if $n_1 = n_2$.*

Definition 1.2.7. We will also say equivalently that

1. a Cartesian space \mathbb{R}^n is an *abstract coordinate system*;
2. a smooth function $\mathbb{R}^{n_1} \rightarrow \mathbb{R}^{n_2}$ is an *abstract coordinate transformation*;
3. the function $p^k : \mathbb{R}^n \rightarrow \mathbb{R}$ is the k th *coordinate* of the coordinate system \mathbb{R}^n . We will also write this function as $x^k : \mathbb{R}^n \rightarrow \mathbb{R}$.
4. for $f : \mathbb{R}^{n_1} \rightarrow \mathbb{R}^{n_2}$ a smooth function, and $1 \leq k \leq n_2$ we write
 - (a) $f^k := p^k \circ f$
 - (b) $(f^1, \dots, f^{n_2}) := f$.

Remark 1.2.8. It follows with this notation that

$$\text{id}_{\mathbb{R}^n} = (x^1, \dots, x^n) : \mathbb{R}^n \rightarrow \mathbb{R}^n.$$

Hence an abstract coordinate transformation

$$f : \mathbb{R}^{n_1} \rightarrow \mathbb{R}^{n_2}$$

may equivalently be written as the tuple

$$(f^1(x^1, \dots, x^{n_1}), \dots, f^{n_2}(x^1, \dots, x^{n_1})).$$

Proposition 1.2.9. *Abstract coordinate systems form a category – to be denoted CartSp – whose*

- *objects are the abstract coordinate systems \mathbb{R}^n (the class of objects is the set \mathbb{N} of natural numbers n);*
- *morphisms $f : \mathbb{R}^{n_1} \rightarrow \mathbb{R}^{n_2}$ are the abstract coordinate transformations = smooth functions.*

Composition of morphisms is given by composition of functions.

We have that

1. *The identity morphisms are precisely the identity functions.*
2. *The isomorphisms are precisely the diffeomorphisms.*

Definition 1.2.10. Write CartSp^{op} for the opposite category of CartSp .

This is the category with the same objects as CartSp , but where a morphism $\mathbb{R}^{n_1} \rightarrow \mathbb{R}^{n_2}$ in CartSp^{op} is given by a morphism $\mathbb{R}^{n_1} \leftarrow \mathbb{R}^{n_2}$ in CartSp .

We will be discussing below the idea of exploring smooth spaces by laying out abstract coordinate systems in them in all possible ways. The reader should begin to think of the sets that appear in the following definition as the *set of ways* of laying out a given abstract coordinate systems in a given space.

Definition 1.2.11. A functor $X : \text{CartSp}^{op} \rightarrow \text{Set}$ (a “presheaf”) is

1. for each abstract coordinate system U a set $X(U)$
2. for each coordinate transformation $f : \mathbb{R}^{n_1} \rightarrow \mathbb{R}^{n_2}$ a function $X(f) : X(\mathbb{R}^{n_1}) \rightarrow X(\mathbb{R}^{n_2})$

such that

1. identity is respected $X(\text{id}_{\mathbb{R}^n}) = \text{id}_{X(\mathbb{R}^n)}$;
2. composition is respected $X(f_2) \circ X(f_1) = X(f_2 \circ f_1)$

1.2.1.3 The fundamental theorems about smooth functions The special properties smooth functions that make them play an important role different from other classes of functions are the following.

1. existence of bump functions and partitions of unity
2. the Hadamard lemma and Borel’s theorem

Or maybe better put: what makes smooth functions special is that the first of these properties holds, while the second is still retained.

1.2.2 Smooth 0-types

We now discuss concretely the definition of smooth sets/smooth spaces and of homomorphisms between them, together with basic examples and properties.

1.2.2.1 Plots of smooth spaces and their gluing The general kind of “smooth space” that we want to consider is something that can be *probed* by laying out coordinate systems inside it, and that can be obtained by *gluing* all the possible coordinate systems in it together.

At this point we want to impose no further conditions on a “space” than this. In particular we do not assume that we know beforehand a set of points underlying X . Instead, we define smooth spaces X entirely *operationally* as something about which we can ask “Which ways are there to lay out \mathbb{R}^n inside X ?” and such that there is a self-consistent answer to this question. The following definitions make precise what we mean by this.

For brevity we will refer “a way to lay out a coordinate system in X ” as a *plot* of X . The first set of consistency conditions on plots of a space is that they respect *coordinate transformations*. This is what the following definition formalizes.

Definition 1.2.12. A *smooth pre-space* X is

1. a collection of sets: for each Cartesian space \mathbb{R}^n (hence for each natural number n) a set

$$X(\mathbb{R}^n) \in \text{Set}$$

– to be thought of as the *set of ways of laying out \mathbb{R}^n inside X* ;

2. for each abstract coordinate transformation, hence for each smooth function $f : \mathbb{R}^{n_1} \rightarrow \mathbb{R}^{n_2}$ a function between the corresponding sets

$$X(f) : X(\mathbb{R}^{n_2}) \rightarrow X(\mathbb{R}^{n_1})$$

– to be thought of as the function that sends a *plot* of X by \mathbb{R}^{n_2} to the correspondingly transformed plot by \mathbb{R}^{n_1} induced by laying out \mathbb{R}^{n_1} inside \mathbb{R}^{n_2} .

such that this is compatible with coordinate transformations:

1. the identity coordinate transformation does not change the plots:

$$X(id_{\mathbb{R}^n}) = id_{X(\mathbb{R}^n)},$$

2. changing plots along two consecutive coordinate transformations $f_1 : \mathbb{R}^{n_1} \rightarrow \mathbb{R}^{n_2}$ and $f_2 : \mathbb{R}^{n_2} \rightarrow \mathbb{R}^{n_3}$ is the same as changing them along the composite coordinate transformation $f_2 \circ f_1$:

$$X(f_1) \circ X(f_2) = X(f_2 \circ f_1).$$

But there is one more consistency condition for a collection of plots to really be probes of some space: it must be true that if we glue small coordinate systems to larger ones, then the plots by the larger ones are the same as the plots by the collection of smaller ones that agree where they overlap. We first formalize this idea of “plots that agree where their coordinate systems overlap”.

Definition 1.2.13. Let X be a smooth pre-space, def. 1.2.12. For $\{U_i \rightarrow \mathbb{R}^n\}_{i \in I}$ a differentially good open cover, def. 4.4.2, let

$$\text{GluedPlots}(\{U_i \rightarrow \mathbb{R}^n\}, X) \in \text{Set}$$

be the set of I -tuples of U_i -plots of X which coincide on all double intersections

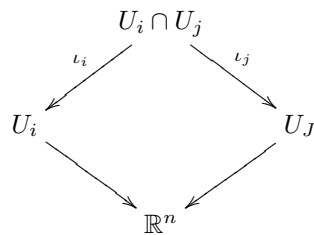

(also called the *matching families* of X over the given cover):

$$\text{GluedPlots}(\{U_i \rightarrow \mathbb{R}^n\}, X) := \{ (p_i \in X(U_i))_{i \in I} \mid \forall_{i,j \in I} : X(\iota_i)(p_i) = X(\iota_j)(p_j) \} .$$

Remark 1.2.14. In def. 1.2.13 the equation

$$X(\iota_i)(p_i) = X(\iota_j)(p_j)$$

says in words:

“The plot p_i of X by the coordinate system U_i inside the bigger coordinate system \mathbb{R}^n coincides with the plot p_j of X by the other coordinate system U_j inside X when both are restricted to the intersection $U_i \cap U_j$ of U_i with U_j inside \mathbb{R}^n .”

Remark 1.2.15. For each differentially good open cover $\{U_i \rightarrow X\}_{i \in I}$ and each smooth pre-space X , def. 1.2.12, there is a canonical function

$$X(\mathbb{R}^n) \rightarrow \text{GluedPlots}(\{U_i \rightarrow \mathbb{R}^n\}, X)$$

from the set of \mathbb{R}^n -plots of X to the set of tuples of glued plots, which sends a plot $p \in X(\mathbb{R}^n)$ to its restriction to all the $\phi_i : U_i \hookrightarrow \mathbb{R}^n$:

$$p \mapsto (X(\phi_i)(p))_{i \in I} .$$

If X is supposed to be consistently probed by coordinate systems, then it must be true that the set of ways of laying out a coordinate system \mathbb{R}^n inside it coincides with the set of ways of laying out tuples of glued coordinate systems inside it, for each good cover $\{U_i \rightarrow \mathbb{R}^n\}$ as above. Therefore:

Definition 1.2.16. A smooth pre-space X , def. 1.2.12 is a *smooth space* if for all differentially good open covers $\{U_i \rightarrow \mathbb{R}^n\}$, def. 4.4.2, the canonical function of remark 1.2.15 from plots to glued plots is a bijection

$$X(\mathbb{R}^n) \xrightarrow{\cong} \text{GluedPlots}(\{U_i \rightarrow \mathbb{R}^n\}, X) .$$

Remark 1.2.17. We may think of a smooth space as being a kind of space whose *local models* (in the general sense discussed at *geometry*) are Cartesian spaces:

while definition 1.2.16 explicitly says that a smooth space is something that is *consistently probeable* by such local models; by a general abstract fact that is sometimes called the *co-Yoneda lemma*, it follows in fact that smooth spaces are precisely the objects that are obtained by *gluing coordinate systems* together.

For instance we will see that two open 2-balls $\mathbb{R}^2 \simeq D^2$ along a common rim yields the smooth space version of the sphere S^2 , a basic example of a smooth manifold. But before we examine such explicit constructions, we discuss here for the moment more general properties of smooth spaces.

Example 1.2.18. For $n \in \mathbb{R}^n$, there is a smooth space, def. 1.2.16, whose set of plots over the abstract coordinate systems \mathbb{R}^k is the set

$$\text{CartSp}(\mathbb{R}^k, \mathbb{R}^n) \in \text{Set}$$

of smooth functions from \mathbb{R}^k to \mathbb{R}^n .

Clearly this is the rule for plots that characterize \mathbb{R}^n itself as a smooth space, and so we will just denote this smooth space by the same symbols “ \mathbb{R}^n ”:

$$\mathbb{R}^n : \mathbb{R}^k \mapsto \text{CartSp}(\mathbb{R}^k, \mathbb{R}^n) .$$

In particular the real line \mathbb{R} is this way itself a smooth space.

In a moment we find a formal justification for this slight abuse of notation.

Another basic class of examples of smooth spaces are the discrete smooth spaces:

Definition 1.2.19. For $S \in \text{Set}$ a set, write

$$\text{Disc}S \in \text{Smooth0Type}$$

for the smooth space whose set of U -plots for every $U \in \text{CartSp}$ is always S .

$$\text{Disc}S: U \mapsto S$$

and which sends every coordinate transformation $f: \mathbb{R}^{n_1} \rightarrow \mathbb{R}^{n_2}$ to the identity function on S .

A smooth space of this form we call a *discrete smooth space*.

More examples of smooth spaces can be built notably by intersecting images of two smooth spaces inside a bigger one. In order to say this we first need a formalization of homomorphism of smooth spaces. This we turn to now.

1.2.2.2 Homomorphisms of smooth spaces We discuss “functions” or “maps” between smooth spaces, def. 1.2.16, which preserve the smooth space structure in a suitable sense. As with any notion of function that preserves structure, we refer to them as *homomorphisms*.

The idea of the following definition is to say that whatever a homomorphism $f: X \rightarrow Y$ between two smooth spaces is, it has to take the plots of X by \mathbb{R}^n to a corresponding plot of Y , such that this respects coordinate transformations.

Definition 1.2.20. Let X and Y be two smooth spaces, def. 1.2.16. Then a homomorphism $f: X \rightarrow Y$ is

- for each abstract coordinate system \mathbb{R}^n (hence for each $n \in \mathbb{N}$) a function $f_{\mathbb{R}^n}: X(\mathbb{R}^n) \rightarrow Y(\mathbb{R}^n)$ that sends \mathbb{R}^n -plots of X to \mathbb{R}^n -plots of Y

such that

- for each smooth function $\phi: \mathbb{R}^{n_1} \rightarrow \mathbb{R}^{n_2}$ we have

$$Y(\phi) \circ f_{\mathbb{R}^{n_1}} = f_{\mathbb{R}^{n_2}} \circ X(\phi),$$

hence a commuting diagram

$$\begin{array}{ccc} X(\mathbb{R}^{n_1}) & \xrightarrow{f_{\mathbb{R}^{n_1}}} & Y(\mathbb{R}^{n_1}) \\ \downarrow X(\phi) & & \downarrow Y(\phi) \\ X(\mathbb{R}^{n_2}) & \xrightarrow{f_{\mathbb{R}^{n_2}}} & Y(\mathbb{R}^{n_1}) \end{array} .$$

For $f_1: X \rightarrow Y$ and $f_2: X \rightarrow Y$ two homomorphisms of smooth spaces, their composition $f_2 \circ f_1: X \rightarrow Y$ is defined to be the homomorphism whose component over \mathbb{R}^n is the composite of functions of the components of f_1 and f_2 :

$$(f_2 \circ f_1)_{\mathbb{R}^n} := f_{2\mathbb{R}^n} \circ f_{1\mathbb{R}^n} .$$

Definition 1.2.21. Write Smooth0Type for the category whose objects are smooth spaces, def. 1.2.16, and whose morphisms are homomorphisms of smooth spaces, def. 1.2.20.

At this point it may seem that we have now *two different* notions for how to lay out a coordinate system in a smooth space X : on the hand, X comes by definition with a rule for what the set $X(\mathbb{R}^n)$ of its \mathbb{R}^n -plots is. On the other hand, we can now regard the abstract coordinate system \mathbb{R}^n itself as a smooth space, by example 1.2.18, and then say that an \mathbb{R}^n -plot of X should be a homomorphism of smooth spaces of the form $\mathbb{R}^n \rightarrow X$.

The following proposition says that these two superficially different notions actually naturally coincide.

Proposition 1.2.22. *Let X be any smooth space, def. 1.2.16, and regard the abstract coordinate system \mathbb{R}^n as a smooth space, by example 1.2.18. There is a natural bijection*

$$X(\mathbb{R}^n) \simeq \text{Hom}_{\text{Smooth0Type}}(\mathbb{R}^n, X)$$

between the postulated \mathbb{R}^n -plots of X and the actual \mathbb{R}^n -plots given by homomorphism of smooth spaces $\mathbb{R}^n \rightarrow X$.

Proof. This is a special case of the *Yoneda lemma*. The reader unfamiliar with this should write out the simple proof explicitly: use the defining commuting diagrams in def. 1.2.20 to deduce that a homomorphism $f : \mathbb{R}^n \rightarrow X$ is uniquely fixed by the image of the identity element in $\mathbb{R}^n(\mathbb{R}^n) := \text{CartSp}(\mathbb{R}^n, \mathbb{R}^n)$ under the component function $f_{\mathbb{R}^n} : \mathbb{R}^n(\mathbb{R}^n) \rightarrow X(\mathbb{R}^n)$. \square

Example 1.2.23. Let $\mathbb{R} \in \text{Smooth0Type}$ denote the real line, regarded as a smooth space by def. 1.2.18. Then for $X \in \text{Smooth0Type}$ any smooth space, a homomorphism of smooth spaces

$$f : X \rightarrow \mathbb{R}$$

is a *smooth function on X* Prop. 1.2.22 says here that when X happens to be an abstract coordinate system regarded as a smooth space by def. 1.2.18, then this general notion of smooth functions between smooth spaces reproduces the basic notion of def. 1.2.2.

Definition 1.2.24. The 0-dimensional abstract coordinate system \mathbb{R}^0 we also call the *point* and regarded as a smooth space we will often write it as

$$* \in \text{Smooth0Type}.$$

For any $X \in \text{Smooth0Type}$, we say that a homomorphism

$$x : * \rightarrow X$$

is a *point of X* .

Remark 1.2.25. By prop. 1.2.22 the points of a smooth space X are naturally identified with its 0-dimensional plots, hence with the “ways of laying out a 0-dimensional coordinate system” in X :

$$\text{Hom}(*, X) \simeq X(\mathbb{R}^0).$$

1.2.2.3 Products and fiber products of smooth spaces

Definition 1.2.26. Let $X, Y \in \text{Smooth0Type}$ by two smooth spaces. Their *product* is the smooth space $X \times Y \in \text{Smooth0Type}$ whose plots are pairs of plots of X and Y :

$$X \times Y(\mathbb{R}^n) := X(\mathbb{R}^n) \times Y(\mathbb{R}^n) \in \text{Set}.$$

The *projection on the first factor* is the homomorphism

$$p_1 : X \times Y \rightarrow X$$

which sends \mathbb{R}^n -plots of $X \times Y$ to those of X by forming the projection of the cartesian product of sets:

$$p_{1\mathbb{R}^n} : X(\mathbb{R}^n) \times Y(\mathbb{R}^n) \xrightarrow{p_1} X(\mathbb{R}^n).$$

Analogously for the *projection to the second factor*

$$p_2 : X \times Y \rightarrow Y.$$

Proposition 1.2.27. Let $*$ = \mathbb{R}^0 be the point, regarded as a smooth space, def. 1.2.24. Then for $X \in \text{Smooth0Type}$ any smooth space the canonical projection homomorphism

$$X \times * \rightarrow X$$

is an isomorphism.

Definition 1.2.28. Let $f: X \rightarrow Z$ and $g: Y \rightarrow Z$ be two homomorphisms of smooth spaces, def. 1.2.20. There is then a new smooth space to be denoted

$$X \times_Z Y \in \text{Smooth0Type}$$

(with f and g understood), called the *fiber product* of X and Y along f and g , and defined as follows:

the set of \mathbb{R}^n -plots of $X \times_Z Y$ is the set of pairs of plots of X and Y which become the same plot of Z under f and g , respectively:

$$(X \times_Z Y)(\mathbb{R}^n) = \{(p_X \in X(\mathbb{R}^n), p_Y \in Y(\mathbb{R}^n)) \mid f_{\mathbb{R}^n}(p_X) = g_{\mathbb{R}^n}(p_Y)\} .$$

1.2.2.4 Smooth mapping spaces and smooth moduli spaces

Definition 1.2.29. Let $\Sigma, X \in \text{Smooth0Type}$ be two smooth spaces, def. 1.2.16. Then the *smooth mapping space*

$$[\Sigma, X] \in \text{Smooth0Type}$$

is the smooth space defined by saying that its set of \mathbb{R}^n -plots is

$$[\Sigma, X](\mathbb{R}^n) := \text{Hom}(\Sigma \times \mathbb{R}^n, X) .$$

Here in $\Sigma \times \mathbb{R}^n$ we first regard the abstract coordinate system \mathbb{R}^n as a smooth space by example 1.2.18 and then we form the product smooth space by def. 1.2.26.

Remark 1.2.30. This means in words that a \mathbb{R}^n -plot of the mapping space $[\Sigma, X]$ is a smooth \mathbb{R}^n -parameterized collection of homomorphisms $\Sigma \rightarrow X$.

Proposition 1.2.31. *There is a natural bijection*

$$\text{Hom}(K, [\Sigma, X]) \simeq \text{Hom}(K \times \Sigma, X)$$

for every smooth space K .

Proof. With a bit of work this is straightforward to check explicitly by unwinding the definitions. It follows however from general abstract results once we realize that $[-, -]$ is of course the *internal hom* of smooth spaces. \square

Remark 1.2.32. This says in words that a smooth function from any K into the mapping space $[\Sigma, X]$ is equivalently a smooth function from $K \times \Sigma$ to X . The latter we may regard as a *K -parameterized smooth collections* of smooth functions $\Sigma \rightarrow X$. Therefore in view of the previous remark 1.2.30 this says that smooth mapping spaces have a universal property not just over abstract coordinate systems, but over all smooth spaces.

We will therefore also say that $[\Sigma, X]$ is the *smooth moduli space* of smooth functions from $\Sigma \rightarrow X$, because it is such that smooth maps $K \rightarrow [\Sigma, X]$ into it *modulate*, as we move around on K , a family of smooth functions $\Sigma \rightarrow X$, depending on K .

Proposition 1.2.33. *The set of points, def. 1.2.24, of a smooth mapping space $[\Sigma, X]$ is the bare set of homomorphism $\Sigma \rightarrow X$: there is a natural isomorphism*

$$\text{Hom}(*, [\Sigma, X]) \simeq \text{Hom}(\Sigma, X) .$$

Proof. Combine prop. 1.2.31 with prop. 1.2.27. □

Example 1.2.34. Given a smooth space $X \in \text{Smooth0Type}$, its smooth *path space* is the smooth mapping space

$$\mathbf{P}X := [\mathbb{R}^1, X].$$

By prop. 1.2.33 the points of PX are indeed precisely the smooth trajectories $\mathbb{R}^1 \rightarrow X$. But PX also knows how to *smoothly vary* such smooth trajectories.

This is central for variational calculus which determines equations of motion in physics.

Remark 1.2.35. In physics, if X is a model for spacetime, then PX may notably be interpreted as the smooth space of worldlines *in* X , hence the smooth space of paths or *trajectories* of a particle in X .

Example 1.2.36. If in the above example 1.2.34 the path is constrained to be a loop in X , one obtains the *smooth loop space*

$$\mathbf{L}X := [S^1, X].$$

1.2.2.5 The smooth moduli space of smooth functions In example 1.2.23 we saw that a smooth function on a general smooth space X is a homomorphism of smooth spaces, def. 1.2.20

$$f: X \rightarrow \mathbb{R}.$$

The collection of these forms the hom-set $\text{Hom}_{\text{Smooth0Type}}(X, \mathbb{R})$. But by the discussion in 1.2.2.4 such hom-sets are naturally refined to smooth spaces themselves.

Definition 1.2.37. For $X \in \text{Smooth0Type}$ a smooth space, we say that the *moduli space of smooth functions* on X is the smooth mapping space (def. 1.2.29), from X into the standard real line \mathbb{R}

$$[X, \mathbb{R}] \in \text{Smooth0Type}.$$

We will also denote this by

$$\mathbf{C}^\infty(X) := [X, \mathbb{R}],$$

since in the special case that X is a Cartesian space this is the smooth refinement of the set $C^\infty(X)$ of smooth functions, def. 1.2.1, on X .

Remark 1.2.38. We call this a *moduli space* because by prop. 1.2.31 above and in the sense of remark 1.2.32 it is such that smooth functions into it *modulate* smooth functions $X \rightarrow \mathbb{R}$.

By prop. 1.2.33 a point $*$ $\rightarrow [X, \mathbb{R}^1]$ of the moduli space is equivalently a smooth function $X \rightarrow \mathbb{R}^1$.

1.2.2.6 Outlook Later we define/see the following:

- A *smooth manifold* is a smooth space that is *locally equivalent* to a coordinate system;
- A *diffeological space* is a smooth space such that every coordinate labels a point in the space. In other words, a diffeological space is a smooth space that has an underlying set $X_s \in \text{Set}$ of points such that the set of \mathbb{R}^n -plots is a subset of the set of all functions:

$$X(\mathbb{R}^n) \hookrightarrow \text{Functions}(\mathbb{R}^n, S_s).$$

We discuss below a long sequence of faithful inclusions

{coordinate systems} \hookrightarrow {smooth manifolds} \hookrightarrow {diffeological spaces} \hookrightarrow {smooth spaces} \hookrightarrow {smooth groupoids} $\hookrightarrow \dots$

1.2.3 Differential forms

A fundamental concept in differential geometry is that of *differential forms*. We here introduce this in the spirit of the topos of smooth spaces.

1.2.3.1 Differential forms on abstract coordinate systems We introduce the basic concept of a *smooth differential form* on a Cartesian space \mathbb{R}^n . Below in 1.2.65 we use this to define differential forms on any smooth space.

Definition 1.2.39. For $n \in \mathbb{N}$ a *smooth differential 1-form* ω on the Cartesian space \mathbb{R}^n is an n -tuple

$$(\omega_i \in \text{CartSp}(\mathbb{R}^n, \mathbb{R}))_{i=1}^n$$

of smooth functions, which we think of equivalently as the coefficients of a formal linear combination

$$\omega = \sum_{i=1}^n f_i \mathbf{d}x^i$$

on a set $\{\mathbf{d}x^1, \mathbf{d}x^2, \dots, \mathbf{d}x^n\}$ of cardinality n .

Write

$$\Omega^1(\mathbb{R}^k) \simeq \text{CartSp}(\mathbb{R}^k, \mathbb{R})^{\times k} \in \text{Set}$$

for the set of smooth differential 1-forms on \mathbb{R}^k .

Remark 1.2.40. We think of $\mathbf{d}x^i$ as a measure for infinitesimal displacements along the x^i -coordinate of a Cartesian space. This idea is made precise by the notion of *parallel transport*.

If we have a measure of infinitesimal displacement on some \mathbb{R}^n and a smooth function $f: \mathbb{R}^{\bar{n}} \rightarrow \mathbb{R}^n$, then this induces a measure for infinitesimal displacement on $\mathbb{R}^{\bar{n}}$ by sending whatever happens there first with f to \mathbb{R}^n and then applying the given measure there. This is captured by the following definition.

Definition 1.2.41. For $\phi: \mathbb{R}^{\bar{k}} \rightarrow \mathbb{R}^k$ a smooth function, the *pullback of differential 1-forms* along ϕ is the function

$$\phi^*: \Omega^1(\mathbb{R}^k) \rightarrow \Omega^1(\mathbb{R}^{\bar{k}})$$

between sets of differential 1-forms, def. 1.2.39, which is defined on basis-elements by

$$\phi^* \mathbf{d}x^i := \sum_{j=1}^{\bar{k}} \frac{\partial \phi^i}{\partial \tilde{x}^j} \mathbf{d}\tilde{x}^j$$

and then extended linearly by

$$\begin{aligned} \phi^* \omega &= \phi^* \left(\sum_i \omega_i \mathbf{d}x^i \right) \\ &:= \sum_{i=1}^k (\phi^* \omega)_i \sum_{j=1}^{\bar{k}} \frac{\partial \phi^i}{\partial \tilde{x}^j} \mathbf{d}\tilde{x}^j \quad . \\ &= \sum_{i=1}^k \sum_{j=1}^{\bar{k}} (\omega_i \circ \phi) \cdot \frac{\partial \phi^i}{\partial \tilde{x}^j} \mathbf{d}\tilde{x}^j \end{aligned}$$

Remark 1.2.42. The term “pullback” in *pullback of differential forms* is not really related, certainly not historically, to the term *pullback* in category theory. One can relate the pullback of differential forms to categorical pullbacks, but this is not really essential here. The most immediate property that both concepts share is that they take a morphism going in one direction to a map between structures over domain and codomain of that morphism which goes in the other direction, and in this sense one is “pulling back structure along a morphism” in both cases.

Even if in the above definition we speak only about the set $\Omega^1(\mathbb{R}^k)$ of differential 1-forms, this set naturally carries further structure.

Definition 1.2.43. The set $\Omega^1(\mathbb{R}^k)$ is naturally an abelian group with addition given by componentwise addition

$$\begin{aligned}\omega + \lambda &= \sum_{i=1}^k \omega_i \mathbf{d}x^i + \sum_{j=1}^k \lambda_j \mathbf{d}x^j \\ &= \sum_{i=1}^k (\omega_i + \lambda_i) \mathbf{d}x^i,\end{aligned}$$

Moreover, the abelian group $\Omega^1(\mathbb{R}^k)$ is naturally equipped with the structure of a module over the ring $C^\infty(\mathbb{R}^k, \mathbb{R}) = \text{CartSp}(\mathbb{R}^k, \mathbb{R})$ of smooth functions, where the action $C^\infty(\mathbb{R}^k, \mathbb{R}) \times \Omega^1(\mathbb{R}^k) \rightarrow \Omega^1(\mathbb{R}^k)$ is given by componentwise multiplication

$$f \cdot \omega = \sum_{i=1}^k (f \cdot \omega_i) \mathbf{d}x^i.$$

Remark 1.2.44. More abstractly, this just says that $\Omega^1(\mathbb{R}^k)$ is the free module over $C^\infty(\mathbb{R}^k)$ on the set $\{\mathbf{d}x^i\}_{i=1}^k$.

The following definition captures the idea that if $\mathbf{d}x^i$ is a measure for displacement along the x^i -coordinate, and $\mathbf{d}x^j$ a measure for displacement along the x^j coordinate, then there should be a way to get a measure, to be called $\mathbf{d}x^i \wedge \mathbf{d}x^j$, for infinitesimal *surfaces* (squares) in the x^i - x^j -plane. And this should keep track of the orientation of these squares, with

$$\mathbf{d}x^j \wedge \mathbf{d}x^i = -\mathbf{d}x^i \wedge \mathbf{d}x^j$$

being the same infinitesimal measure with orientation reversed.

Definition 1.2.45. For $k, n \in \mathbb{N}$, the *smooth differential forms* on \mathbb{R}^k is the exterior algebra

$$\Omega^\bullet(\mathbb{R}^k) := \wedge_{C^\infty(\mathbb{R}^k)}^\bullet \Omega^1(\mathbb{R}^k)$$

over the ring $C^\infty(\mathbb{R}^k)$ of smooth functions of the module $\Omega^1(\mathbb{R}^k)$ of smooth 1-forms, prop. 1.2.43.

We write $\Omega^n(\mathbb{R}^k)$ for the sub-module of degree n and call its elements the *smooth differential n -forms*.

Remark 1.2.46. Explicitly this means that a differential n -form $\omega \in \Omega^n(\mathbb{R}^k)$ on \mathbb{R}^k is a formal linear combination over $C^\infty(\mathbb{R}^k)$ of basis elements of the form $\mathbf{d}x^{i_1} \wedge \cdots \wedge \mathbf{d}x^{i_n}$ for $i_1 < i_2 < \cdots < i_n$:

$$\omega = \sum_{1 \leq i_1 < i_2 < \cdots < i_n < k} \omega_{i_1, \dots, i_n} \mathbf{d}x^{i_1} \wedge \cdots \wedge \mathbf{d}x^{i_n}.$$

Remark 1.2.47. The pullback of differential 1-forms of def. 1.2.39 extends as an $C^\infty(\mathbb{R}^k)$ -algebra homomorphism to $\Omega^n(-)$, given for a smooth function $f: \mathbb{R}^{\tilde{k}} \rightarrow \mathbb{R}^k$ on basis elements by

$$f^*(\mathbf{d}x^{i_1} \wedge \cdots \wedge \mathbf{d}x^{i_n}) = (f^* \mathbf{d}x^{i_1} \wedge \cdots \wedge f^* \mathbf{d}x^{i_n}).$$

1.2.3.2 Differential forms on smooth spaces Above we have defined differential n -form on abstract coordinate systems. Here we extend this definition to one of differential n -forms on arbitrary smooth spaces. We start by observing that the space of *all* differential n -forms on coordinate systems themselves naturally is a smooth space.

Proposition 1.2.48. *The assignment of differential n -forms*

$$\Omega^n(-): \mathbb{R}^k \mapsto \Omega^n(\mathbb{R}^k)$$

of def. 1.2.45 together with the pullback of differential forms-functions of def. 1.2.47

$$\begin{array}{ccc} \mathbb{R}^{k_1} & \xrightarrow{\quad} & \Omega^1(\mathbb{R}^{k_1}) \\ f \uparrow & & \downarrow f^* \\ \mathbb{R}^{k_2} & \xrightarrow{\quad} & \Omega^1(\mathbb{R}^{k_2}) \end{array}$$

defines a smooth space in the sense of def. 1.2.16:

$$\Omega^n(-) \in \text{Smooth0Type}.$$

Definition 1.2.49. We call this

$$\Omega^n: \text{Smooth0Type}$$

the *universal smooth moduli space* of differential n -forms.

The reason for this terminology is that homomorphisms of smooth spaces into Ω^1 *modulate* differential n -forms on their domain, by prop. 1.2.22 (and hence by the Yoneda lemma):

Example 1.2.50. For the Cartesian space \mathbb{R}^k regarded as a smooth space by example 1.2.18, there is a natural bijection

$$\Omega^n(\mathbb{R}^k) \simeq \text{Hom}(\mathbb{R}^k, \Omega^1)$$

between the set of smooth n -forms on \mathbb{R}^n according to def. 1.2.39 and the set of homomorphism of smooth spaces, $\mathbb{R}^k \rightarrow \Omega^1$, according to def. 1.2.20.

In view of this we have the following elegant definition of smooth n -forms on an arbitrary smooth space.

Definition 1.2.51. For $X \in \text{Smooth0Type}$ a smooth space, def. 1.2.16, a *differential n -form* on X is a homomorphism of smooth spaces of the form

$$\omega: X \rightarrow \Omega^n(-).$$

Accordingly we write

$$\Omega^n(X) := \text{Smooth0Type}(X, \Omega^n)$$

for the set of smooth n -forms on X .

We may unwind this definition to a very explicit description of differential forms on smooth spaces. This we do in a moment in remark 1.2.55.

Notice the following

Proposition 1.2.52. *Differential 0-forms are equivalently smooth \mathbb{R} -valued functions:*

$$\Omega^0 \simeq \mathbb{R}.$$

Definition 1.2.53. For $f: X \rightarrow Y$ a homomorphism of smooth spaces, def. 1.2.20, the *pullback of differential forms* along f is the function

$$f^*: \Omega^n(Y) \rightarrow \Omega^n(X)$$

given by the hom-functor into the smooth space Ω^n of def. 1.2.49:

$$f^* := \text{Hom}(-, \Omega^n).$$

This means that it sends an n -form $\omega \in \Omega^n(Y)$ which is modulated by a homomorphism $Y \rightarrow \Omega^n$ to the n -form $f^*\omega \in \Omega^n(X)$ which is modulated by the composition—composite $X \xrightarrow{f} Y \rightarrow \Omega^n$.

By the Yoneda lemma we find:

Proposition 1.2.54. For $X = \mathbb{R}^{\tilde{k}}$ and $Y = \mathbb{R}^k$ definition 1.2.53 reproduces def. 1.2.47.

Remark 1.2.55. Using def. 1.2.53 for unwinding def. 1.2.51 yields the following explicit description: a differential n -form $\omega \in \Omega^n(X)$ on a smooth space X is

1. for each way $\phi: \mathbb{R}^k \rightarrow X$ of laying out a coordinate system \mathbb{R}^k in X a differential n -form

$$\phi^*\omega \in \Omega^n(\mathbb{R}^k)$$

on the abstract coordinate system, as given by def. 1.2.45;

2. for each abstract coordinate transformation $f: \mathbb{R}^{k_2} \rightarrow \mathbb{R}^{k_1}$ a corresponding compatibility condition between local differential forms $\phi_1: \mathbb{R}^{k_1} \rightarrow X$ and $\phi_2: \mathbb{R}^{k_2} \rightarrow X$ of the form

$$f^*\phi_1^*\omega = \phi_2^*\omega.$$

Hence a differential form on a smooth space is simply a collection of differential forms on all its coordinate systems such that these glue along all possible coordinate transformations.

The following adds further explanation to the role of $\Omega^n \in \text{Smooth0Type}$ as a *moduli space*. Notice that since Ω^n is itself a smooth space, we may speak about differential n -forms on Ω^n itself.

Definition 1.2.56. The *universal differential n -forms* is the differential n -form

$$\omega_{\text{univ}}^n \in \Omega^n(\Omega^n)$$

which is modulated by the identity homomorphism $id: \Omega^n \rightarrow \Omega^n$.

With this definition we have:

Proposition 1.2.57. For $X \in \text{Smooth0Type}$ any smooth space, every differential n -form on X , $\omega \in \Omega^n(X)$ is the pullback of differential forms, def. 1.2.53, of the universal differential n -form, def. 1.2.56, along a homomorphism f from X into the moduli space Ω^n of differential n -forms:

$$\omega = f^*\omega_{\text{univ}}^n.$$

Remark 1.2.58. This statement is of course in a way a big tautology. Nevertheless it is a very useful tautology to make explicit. The whole concept of differential forms on smooth spaces here may be thought of as simply a variation of the theme of the Yoneda lemma.

1.2.3.3 Concrete smooth spaces The smooth universal moduli space of differential forms $\Omega^n(-)$ from def. 1.2.49 is noteworthy in that it has a property not shared by many smooth spaces that one might think of more naively: while evidently being “large” (the space of all differential forms!) it has “very few points” and “very few k -dimensional subspaces” for low k . In fact

Proposition 1.2.59. *For $k < n$ the smooth space Ω^n admits only a unique probe by \mathbb{R}^k :*

$$\mathrm{Hom}(\mathbb{R}^k, \Omega^n) \simeq \Omega^n(\mathbb{R}^k) = \{0\}.$$

So while Ω^n is a large smooth space, it is “not supported on probes” in low dimensions in as much as one might expect, from more naive notions of smooth spaces.

We now formalize this. The formal notion of an smooth space which is *supported on its probes* is that of a *concrete object*. There is a universal map that sends any smooth space to its *concretification*. The universal moduli spaces of differential forms turn out to be *non-concrete* in that their concretification is the point.

Definition 1.2.60. Let \mathbf{H} be a local topos. Write $\sharp: \mathbf{H} \rightarrow \mathbf{H}$ for the corresponding sharp modality, def. 3.4.5. Then.

1. An object $X \in \mathbf{H}$ is called a *concrete object* if

$$\mathrm{DeCoh}_X: X \rightarrow \sharp X$$

is a monomorphism.

2. For $X \in \mathbf{H}$ any object, its *concretification* $\mathrm{Conc}(X) \in \mathbf{H}$ is the image factorization of DeCoh_X , hence the factorization into an epimorphism followed by a monomorphism

$$\mathrm{DeCoh}_X: X \rightarrow \mathrm{Conc}(X) \hookrightarrow \sharp X.$$

Remark 1.2.61. Hence the concretification $\mathrm{Conc}(X)$ of an object X is itself a concrete object and it is universal property—universal with this property.

Proposition 1.2.62. *Let C be a site of definition for the local topos \mathbf{H} , with terminal object $*$. Then for $X: C^{op} \rightarrow \mathrm{Set}$ a sheaf, DeCoh_X is given over $U \in C$ by*

$$X(U) \xrightarrow{\simeq} \mathbf{H}(U, X) \xrightarrow{\Gamma_{U,X}} \mathrm{Set}(\Gamma(U), \Gamma(X)).$$

Proposition 1.2.63. *For $n \geq 1$ we have*

$$\mathrm{Conc}(\Omega^n) \simeq *.$$

In this sense the smooth moduli space of differential n -forms is *maximally non-concrete*.

1.2.3.4 Smooth moduli spaces of differential forms on a smooth space We discuss the smooth space of differential forms *on a fixed smooth space X* .

Remark 1.2.64. For X a smooth space, the smooth mapping space $[X, \Omega^n] \in \mathrm{Smooth0Type}$ is the smooth space whose \mathbb{R}^k -plots are differential n -forms on the product $X \times \mathbb{R}^k$

$$[X, \Omega^n]: \mathbb{R}^k \mapsto \Omega^n(X \times \mathbb{R}^k).$$

This is not *quite* what one usually wants to regard as an \mathbb{R}^k -parameterized of differential forms on X . That is instead usually meant to be a differential form ω on $X \times \mathbb{R}^k$ which has “no leg along \mathbb{R}^k ”. Another way to say this is that the family of forms on X that is represented by some ω on $X \times \mathbb{R}^k$ is that which over a point $v: * \rightarrow \mathbb{R}^k$ has the value $(id_X, v)^*\omega$. Under this pullback of differential forms any components of ω with “legs along \mathbb{R}^k ” are identified with the 0 differential form

This is captured by the following definition.

Definition 1.2.65. For $X \in \text{Smooth0Type}$ and $n \in \mathbb{N}$, the *smooth space of differential n -forms* $\Omega^n(X)$ on X is the concretification, def. 1.2.60, of the smooth mapping space $[X, \Omega^n]$, def. 1.2.29, into the smooth moduli space of differential n -forms, def. 1.2.49:

$$\Omega^n(X) := \text{Conc}([X, \Omega^n]).$$

Proposition 1.2.66. *The \mathbb{R}^k -plots of $\Omega^n(\mathbb{R}^k)$ are indeed smooth differential n -forms on $X \times \mathbb{R}^k$ which are such that their evaluation on vector fields tangent to \mathbb{R}^k vanish.*

Proof. By def. 1.2.60 and prop. 1.2.62 the set of plots of $\Omega^n(X)$ over \mathbb{R}^k is the image of the function

$$\Omega^n(X \times \mathbb{R}^k) \simeq \text{Hom}_{\text{Smooth0Type}}(\mathbb{R}^k, [X, \Omega^n]) \xrightarrow{\Gamma_{\mathbb{R}^k, [X, \Omega^n]}} \text{Hom}_{\text{Set}}(\Gamma(\mathbb{R}^k), \Gamma[X, \Omega^n]) \simeq \text{Hom}_{\text{Set}}(\mathbb{R}_s^k, \Omega^n(X)),$$

where on the right \mathbb{R}_s^k denotes, just for emphasis, the underlying set of \mathbb{R}_s^k . This function manifestly sends a smooth differential form $\omega \in \Omega^n(X \times \mathbb{R}^k)$ to the function from points v of \mathbb{R}^k to differential forms on X given by

$$\omega \mapsto (v \mapsto (id_X, v)^* \omega).$$

Under this function all components of differential forms with a "leg along" \mathbb{R}^k are sent to the 0-form. Hence the image of this function is the collection of smooth forms on $X \times \mathbb{R}^k$ with "no leg along \mathbb{R}^k ". \square

Remark 1.2.67. For $n = 0$ we have (for any $X \in \text{Smooth0Type}$)

$$\begin{aligned} \Omega^0(X) &:= \text{Conc}[X, \Omega^1] \\ &\simeq \text{Conc}[X, \mathbb{R}] \quad , \\ &\simeq [X, \mathbb{R}] \end{aligned}$$

by prop. 1.2.67.

1.2.4 Smooth homotopy types

Here we give an introduction to and a survey of the general theory of cohesive differential geometry that is developed in detail below in 3 below.

The framework of all our constructions is *topos theory* [Joh02] or rather, more generally, *∞ -topos theory* [L-Topos]. In 1.2.4.1 and 1.2.4.2 below we recall and survey basic notions with an eye towards our central example of an ∞ -topos: that of smooth ∞ -groupoids. In these sections the reader is assumed to be familiar with basic notions of category theory (such as adjoint functors) and basic notions of homotopy theory (such as weak homotopy equivalences). A brief introduction to relevant basic concepts (such as Kan complexes and homotopy pullbacks) is given in section 1.2.4, which can be read independently of the discussion here.

Then in 1.2.4.3 and 1.2.4.4 we describe, similarly in a leisurely manner, the intrinsic notions of cohomology and geometric homotopy in an ∞ -topos. Several aspects of the discussion are fairly well-known, we put them in the general perspective of (cohesive) ∞ -topos theory and then go beyond.

Finally in 1.2.6.2 we indicate how the combination of the intrinsic cohomology and geometric homotopy in a locally ∞ -connected ∞ -topos yields an intrinsic notion of differential cohomology in an ∞ -topos.

- 1.2.4.1 – Toposes;
- 1.2.4.2 – ∞ -Toposes;

- 1.2.4.3 – Cohomology;
- 1.2.4.4 – Homotopy;
- 1.2.6.2 – Differential cohomology.

Each of these topics surveyed here are discussed in technical detail below in 3.

1.2.4.1 Toposes There are several different perspectives on the notion of *topos*. One is that a topos is a category that looks like a category of spaces that sit by local homeomorphisms over a given base space: all spaces that are locally modeled on a given base space.

The archetypical class of examples are sheaf toposes over a topological space X denoted $\text{Sh}(X)$. These are equivalently categories of étale spaces over X : topological spaces Y that are equipped with a local homeomorphism $Y \rightarrow X$. When $X = *$ is the point, this is just the category Set of all sets: spaces that are modeled on the point. This is the archetypical topos itself.

What makes the notion of toposes powerful is the following fact: even though the general topos contains objects that are considerably different from and possibly considerably richer than plain sets and even richer than étale spaces over a topological space, the general abstract category theoretic properties of every topos are essentially the same as those of Set . For instance in every topos all small limits and colimits exist and it is cartesian closed (even locally). This means that a large number of constructions in Set have immediate analogs internal to every topos, and the analogs of the statements about these constructions that are true in Set are true in every topos.

This may be thought of as saying that toposes are *very nice categories of spaces* in that whatever construction on spaces one thinks of – for instance formation of quotients or of intersections or of mapping spaces – the resulting space with the expected general abstract properties will exist in the topos. In this sense toposes are *convenient categories for geometry* – as in: *convenient category of topological spaces*, but even more convenient than that.

On the other hand, we can de-emphasize the role of the objects of the topos and instead treat the topos itself as a “generalized space” (and in particular, a categorified space). We then consider the sheaf topos $\text{Sh}(X)$ as a representative of X itself, while toposes not of this form are “honestly generalized” spaces. This point of view is supported by the fact that the assignment $X \mapsto \text{Sh}(X)$ is a full embedding of (sufficiently nice) topological spaces into toposes, and that many topological properties of a space X can be detected at the level of $\text{Sh}(X)$.

Here we are mainly concerned with toposes that are far from being akin to sheaves over a topological space, and instead behave like abstract *fat points with geometric structure*. This implies that the objects of these toposes are in turn generalized spaces modeled locally on this geometric structure. Such toposes are called *gros toposes* or *big toposes*. There is a formalization of the properties of a topos that make it behave like a big topos of generalized spaces inside of which there is geometry: this is the notion of *cohesive toposes*.

1.2.4.1.1 Sheaves More concretely, the idea of sheaf toposes formalizes the idea that any notion of space is typically modeled on a given collection of simple test spaces. For instance differential geometry is the geometry that is modeled Cartesian spaces \mathbb{R}^n , or rather on the category $C = \text{CartSp}$ of Cartesian spaces and smooth functions between them.

A presheaf on such C is a functor $X : C^{\text{op}} \rightarrow \text{Set}$ from the opposite category of C to the category of sets. We think of this as a rule that assigns to each test space $U \in C$ the set $X(U) := \text{Maps}(U, X)$ of structure-preserving maps from the test space U into the would-be space X - the *probes* of X by the test space U . This assignment defines the generalized space X modeled on C . Every category of presheaves over a small category is an example of a topos. But these presheaf toposes, while encoding the *geometry* of generalized spaces by means of probes by test spaces in C fail to correctly encode the *topology* of these spaces. This is captured by restricting to *sheaves* among all presheaves.

Each test space $V \in C$ itself specifies presheaf, by forming the hom-sets $\text{Maps}(U, V) := \text{Hom}_C(U, V)$ in C . This is called the *Yoneda embedding* of test spaces into the collection of all generalized spaces modeled

on them. Presheaves of this form are the *representable presheaves*. A bit more general than these are the *locally representable presheaves*: for instance on $C = \text{CartSp}$ this are the smooth manifolds $X \in \text{SmoothMfd}$, whose presheaf-rule is $\text{Maps}(U, X) := \text{Hom}_{\text{SmoothMfd}}(U, X)$. By definition, a manifold is locally isomorphic to a Cartesian space, hence is locally representable as a presheaf on CartSp .

These examples of presheaves on C are special in that they are in fact *sheaves*: the value of X on a test space U is entirely determined by the restrictions to each U_i in a *cover* $\{U_i \rightarrow U\}_{i \in I}$ of the test space U by other test spaces U_i . We think of the subcategory of sheaves $\text{Sh}(C) \hookrightarrow \text{PSh}(C)$ as consisting of those special presheaves that are those rules of probe-assignments which respect a certain notion of ways in which test spaces $U, V \in C$ may glue together to a bigger test space.

One may axiomatize this by declaring that the collections of all covers under consideration forms what is called a *Grothendieck topology* on C that makes C a *site*. But of more intrinsic relevance is the equivalent fact that categories of sheaves are precisely the subtoposes of presheaves toposes

$$\text{Sh}(C) \underset{\hookrightarrow}{\overset{L}{\longleftarrow}} \text{PSh}(C) \equiv [C^{\text{op}}, \text{Set}] ,$$

meaning that the embedding $\text{Sh}(C) \hookrightarrow \text{PSh}(C)$ has a left adjoint functor L that preserves finite limits. This may be taken to be the *definition* of Grothendieck toposes. The left adjoint is called the *sheafification functor*. It is determined by and determines a Grothendieck topology on C .

For the choice $C = \text{CartSp}$ such is naturally given by the good open cover coverage, which says that a bunch of maps $\{U_i \rightarrow U\}$ in C exhibit the test object U as being glued together from the test objects $\{U_i\}$ if these form a good open cover of U . With this notion of coverage every smooth manifold is a sheaf on CartSp .

But there are important generalized spaces modeled on CartSp that are not smooth manifolds: topological spaces for which one can consistently define which maps from Cartesian spaces into them count as smooth in a way that makes this assignment a sheaf on CartSp , but which are not necessarily locally isomorphic to a Cartesian space: these are called *diffeological spaces*. A central example of a space that is naturally a diffeological space but not a finite dimensional manifold is a mapping space $[\Sigma, X]$ of smooth functions between smooth manifolds Σ and X : since the idea is that for U any Cartesian space the smooth U -parameterized families of points in $[\Sigma, X]$ are smooth U -parameterized families of smooth maps $\Sigma \rightarrow X$, we can take the plot-assigning rule to be

$$[\Sigma, X] : U \mapsto \text{Hom}_{\text{SmoothMfd}}(\Sigma \times U, X) .$$

It is useful to relate all these phenomena in the topos $\text{Sh}(C)$ to their image in the archetypical topos Set . This is simply the category of sets, which however we should think of here as the category $\text{Set} \simeq \text{Sh}(*)$ of sheaves on the category $*$ which contains only a single object and no nontrivial morphism: objects in here are generalized spaces *modeled on the point*. All we know about them is how to map the point into them, and as such they are just the sets of all possible such maps from the point.

Every category of sheaves $\text{Sh}(C)$ comes canonically with an essentially unique topos morphism to the topos of sets, given by a pair of adjoint functors

$$\text{Sh}(C) \underset{\Gamma}{\overset{\text{Disc}}{\longleftrightarrow}} \text{Sh}(*) \simeq \text{Set} .$$

Here Γ is called the *global sections functor*. If C has a terminal object $*$, then it is given by evaluation on that object: the functor Γ sends a plot-assigning rule $X : C^{\text{op}} \rightarrow \text{Set}$ to the set of plots by the point $\Gamma(X) = X(*)$. For instance in $C = \text{CartSp}$ the terminal object exists and is the ordinary point $* = \mathbb{R}^0$. If $X \in \text{Sh}(C)$ is a smooth manifold or diffeological space as above, then $\Gamma(X) \in \text{Set}$ is simply its underlying set of points. So the functor Γ can be thought of as forgetting the *cohesive structure* that is given by the fact that our generalized spaces are modeled on C . It remembers only the underlying point-set.

Conversely, its left adjoint functor Disc takes a set S to the sheafification $\text{Disc}(S) = L\text{Const}(S)$ of the constant presheaf $\text{Const} : U \mapsto S$, which asserts that the set of its plots by any test space is always the

same set S . This is the plot-rule for the *discrete space* modeled on C given by the set S : a plot has to be a constant map of the test space U to one of the elements $s \in S$. For the case $C = \text{CartSp}$ this interpretation is literally true in the familiar sense: the generalized smooth space $\text{Disc}(S)$ is the discrete smooth manifold or discrete diffeological space with point set S .

1.2.4.1.2 Concrete and non-concrete sheaves The examples for generalized spaces X modeled on C that we considered so far all had the property that the collection of plots $U \rightarrow X$ into them was a subset of the set of maps of sets from U to their underlying set $\Gamma(X)$ of points. These are called *concrete sheaves*. Not every sheaf is concrete. The concrete sheaves form a subcategory inside the full topos which is itself almost, but not quite a topos: it is the *quasitopos* of concrete objects.

$$\text{Conc}(C) \underset{C}{\overset{\longleftarrow}{\rightleftarrows}} \text{Sh}(C) .$$

Non-concrete sheaves over C may be exotic as compared to smooth manifolds, but they are still usefully regarded as generalized spaces modeled on C . For instance for $n \in \mathbb{N}$ there is the sheaf $\kappa(n, \mathbb{R})$ given by saying that plots by $U \in \text{CartSp}$ are identified with closed differential n -forms on U :

$$\kappa(n, \mathbb{R}) : U \mapsto \Omega_{\text{cl}}^n(U) .$$

This sheaf describes a very non-classical space, which for $n \geq 1$ has only a single point, $\Gamma(\kappa(n, \mathbb{R})) = *$, only a single curve, a single surface, etc., up to a single $(n-1)$ -dimensional probe, but then it has a large number of n -dimensional probes. Despite the fact that this sheaf is very far in nature from the test spaces that it is modeled on, it plays a crucial and very natural role: it is in a sense a model for an Eilenberg-MacLane space $K(n, \mathbb{R})$. We shall see in 4.4.14 that these sheaves are part of an incarnation of the ∞ -Lie-algebra $b^n \mathbb{R}$ and the sense in which it models an Eilenberg-MacLane space is that of Sullivan models in rational homotopy theory. In any case, we want to allow ourselves to regard non-concrete objects such as $\kappa(n, \mathbb{R})$ on the same footing as diffeological spaces and smooth manifolds.

1.2.4.2 ∞ -Toposes While therefore a general object in the sheaf topos $\text{Sh}(C)$ may exhibit a considerable generalization of the objects $U \in C$ that it is modeled on, for many natural applications this is still not quite general enough: if for instance X is a *smooth orbifold* (see for instance [MoPr97]), then there is not just a set, but a *groupoid* of ways of probing it by a Cartesian test space U : if a probe $\gamma : U \rightarrow X$ is connected by an orbifold transformation to another probe $\gamma' : U \rightarrow X$, then this constitutes a morphism in the groupoid $X(U)$ of probes of X by U .

Even more generally, there may be a genuine ∞ -*groupoid* of probes of the generalized space X by the test space U : a set of probes with morphisms between different probes, 2-morphisms between these 1-morphisms, and so on.

Such structures are described in ∞ -*category theory*: where a category has a set of morphisms between any two objects, an ∞ -category has an ∞ -groupoid of morphisms, whose compositions are defined up to higher coherent homotopy. The theory of ∞ -categories is effectively the combination of category theory and homotopy theory. The main fact about it, emphasized originally by André Joyal and then further developed in [L-Topos], is that it behaves formally entirely analogously to category theory: there are notions of ∞ -functors, ∞ -limits, adjoint ∞ -functors etc., that satisfy all the familiar relations from category theory.

1.2.4.2.1 ∞ -Groupoids We first look at bare ∞ -groupoids and then discuss how to equip these with smooth structure.

An ∞ -groupoid is first of all supposed to be a structure that has *k-morphisms* for all $k \in \mathbb{N}$, which for $k \geq 1$ go between $(k-1)$ -morphisms. A useful tool for organizing such collections of morphisms is the notion of a *simplicial set*. This is a functor on the opposite category of the simplex category Δ , whose objects are the abstract cellular k -simplices, denoted $[k]$ or $\Delta[k]$ for all $k \in \mathbb{N}$, and whose morphisms $\Delta[k_1] \rightarrow \Delta[k_2]$ are all ways of mapping these into each other. So we think of such a simplicial set given by a functor

$$K : \Delta^{\text{op}} \rightarrow \text{Set}$$

as specifying

- a set $[0] \mapsto K_0$ of *objects*;
- a set $[1] \mapsto K_1$ of *morphisms*;
- a set $[2] \mapsto K_2$ of *2-morphisms*;
- a set $[3] \mapsto K_3$ of *3-morphisms*;

and generally

- a set $[k] \mapsto K_k$ of *k-morphisms*.

as well as specifying

- functions $([n] \hookrightarrow [n+1]) \mapsto (K_{n+1} \rightarrow K_n)$ that send $n+1$ -morphisms to their boundary n -morphisms;
- functions $([n+1] \rightarrow [n]) \mapsto (K_n \rightarrow K_{n+1})$ that send n -morphisms to identity $(n+1)$ -morphisms on them.

The fact that K is supposed to be a functor enforces that these assignments of sets and functions satisfy conditions that make consistent our interpretation of them as sets of k -morphisms and source and target maps between these. These are called the *simplicial identities*. But apart from this source-target matching, a generic simplicial set does not yet encode a notion of *composition* of these morphisms.

For instance for $\Lambda^1[2]$ the simplicial set consisting of two attached 1-cells

$$\Lambda^1[2] = \left\{ \begin{array}{ccc} & 1 & \\ \nearrow & & \searrow \\ 0 & & 2 \end{array} \right\}$$

and for $(f, g) : \Lambda^1[2] \rightarrow K$ an image of this situation in K , hence a pair $x_0 \xrightarrow{f} x_1 \xrightarrow{g} x_2$ of two *composable* 1-morphisms in K , we want to demand that there exists a third 1-morphisms in K that may be thought of as the *composition* $x_0 \xrightarrow{h} x_2$ of f and g . But since we are working in higher category theory, we want to identify this composite only up to a 2-morphism equivalence

$$\begin{array}{ccc} & x_1 & \\ f \nearrow & & \searrow g \\ x_0 & \xrightarrow{h} & x_2 \\ & \Downarrow \simeq & \end{array} .$$

From the picture it is clear that this is equivalent to demanding that for $\Lambda^1[2] \hookrightarrow \Delta[2]$ the obvious inclusion of the two abstract composable 1-morphisms into the 2-simplex we have a diagram of morphisms of simplicial sets

$$\begin{array}{ccc} \Lambda^1[2] & \xrightarrow{(f,g)} & K \\ \downarrow & \nearrow \exists h & \\ \Delta[2] & & \end{array} .$$

A simplicial set where for all such (f, g) a corresponding such h exists may be thought of as a collection of higher morphisms that is equipped with a notion of composition of adjacent 1-morphisms.

For the purpose of describing groupoidal composition, we now want that this composition operation has all inverses. For that purpose, notice that for

$$\Lambda^2[2] = \left\{ \begin{array}{c} & & 1 & & \\ & \nearrow & & \searrow & \\ 0 & & & & 2 \end{array} \right\}$$

the simplicial set consisting of two 1-morphisms that touch at their end, hence for

$$(g, h) : \Lambda^2[2] \rightarrow K$$

two such 1-morphisms in K , then if g had an inverse g^{-1} we could use the above composition operation to compose that with h and thereby find a morphism f connecting the sources of h and g . This being the case is evidently equivalent to the existence of diagrams of morphisms of simplicial sets of the form

$$\begin{array}{ccc} \Lambda^2[2] & \xrightarrow{(g,h)} & K \\ \downarrow & \nearrow \exists f & \\ \Delta[2] & & \end{array}$$

Demanding that all such diagrams exist is therefore demanding that we have on 1-morphisms a composition operation with inverses in K .

In order for this to qualify as an ∞ -groupoid, this composition operation needs to satisfy an associativity law up to 2-morphisms, which means that we can find the relevant tetrahedra in K . These in turn need to be connected by *pentagonators* and ever so on. It is a nontrivial but true and powerful fact, that all these coherence conditions are captured by generalizing the above conditions to all dimensions in the evident way:

Let $\Lambda^i[n] \hookrightarrow \Delta[n]$ be the simplicial set – called the *ith n-horn* – that consists of all cells of the n -simplex $\Delta[n]$ except the interior n -morphism and the *ith* $(n - 1)$ -morphism.

Then a simplicial set is called a *Kan complex*, if for all images $f : \Lambda^i[n] \rightarrow K$ of such horns in K , the missing two cells can be found in K – in that we can always find a *horn filler* σ in the diagram

$$\begin{array}{ccc} \Lambda^i[n] & \xrightarrow{f} & K \\ \downarrow & \nearrow \exists \sigma & \\ \Delta[n] & & \end{array}$$

The basic example is the *nerve* $N(C) \in \mathbf{sSet}$ of an ordinary groupoid C , which is the simplicial set with $N(C)_k$ being the set of sequences of k composable morphisms in C . The nerve operation is a full and faithful functor from 1-groupoids into Kan complexes and hence may be thought of as embedding 1-groupoids in the context of general ∞ -groupoids.

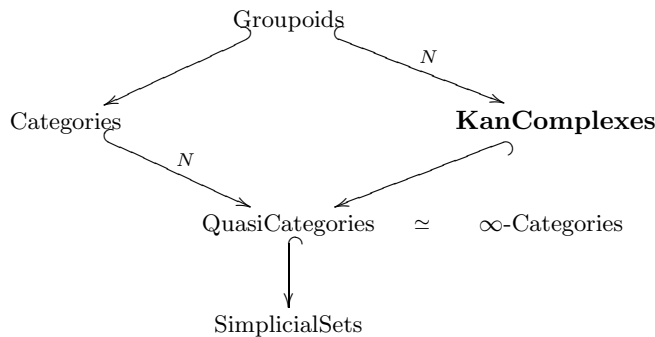

But we need a bit more than just bare ∞ -groupoids. In generalization to Lie groupoids, we need *smooth ∞ -groupoids*. A useful way to encode that an ∞ -groupoid has extra structure modeled on geometric test objects that themselves form a category C is to remember the rule which for each test space U in C produces the ∞ -groupoid of U -parameterized families of k -morphisms in K . For instance for a smooth ∞ -groupoid we could test with each Cartesian space $U = \mathbb{R}^n$ and find the ∞ -groupoids $K(U)$ of smooth n -parameter families of k -morphisms in K .

This data of U -families arranges itself into a presheaf with values in Kan complexes

$$K : C^{\text{op}} \rightarrow \text{KanCplx} \hookrightarrow \text{sSet} ,$$

hence with values in simplicial sets. This is equivalently a simplicial presheaf of sets. The functor category $[C^{\text{op}}, \text{sSet}]$ on the opposite category of the category of test objects C serves as a model for the ∞ -category of ∞ -groupoids with C -structure.

While there are no higher morphisms in this functor 1-category that could for instance witness that two ∞ -groupoids are not isomorphic, but still equivalent, it turns out that all one needs in order to reconstruct *all* these higher morphisms (up to equivalence!) is just the information of which morphisms of simplicial presheaves would become invertible if we were keeping track of higher morphism. These would-be invertible morphisms are called *weak equivalences* and denoted $K_1 \xrightarrow{\simeq} K_2$.

For common choices of C there is a well-understood way to define the weak equivalences $W \subset \text{Mor}[C^{\text{op}}, \text{sSet}]$, and equipped with this information the category of simplicial presheaves becomes a *category with weak equivalences*. There is a well-developed but somewhat intricate theory of how exactly this 1-categorical data models the full higher category of structured groupoids that we are after, but for our purposes here we essentially only need to work inside the category of *fibrant* objects of a model structure on presheaves, which in practice amounts to the fact that we use the following three basic constructions:

1. **∞ -anafunctor** A morphism $X \rightarrow Y$ between ∞ -groupoids with C -structure is not just a morphism $X \rightarrow Y$ in $[C^{\text{op}}, \text{sSet}]$, but is a span of such ordinary morphisms

$$\begin{array}{ccc} \hat{X} & \longrightarrow & Y \\ \downarrow \simeq & & \\ X & & \end{array}$$

where the left leg is a weak equivalence. This is sometimes called an ∞ -*anafunctor* from X to Y .

2. **homotopy pullback** – For $A \rightarrow B \xleftarrow{p} C$ a diagram, the ∞ -pullback of it is the ordinary pullback in $[C^{\text{op}}, \text{sSet}]$ of a replacement diagram $A \rightarrow B \xleftarrow{\hat{p}} \hat{C}$, where \hat{p} is a *good replacement* of p in the sense of the following factorization lemma.

Proposition 1.2.68 (factorization lemma). *For $p : C \rightarrow B$ a morphism in $[C^{\text{op}}, \text{sSet}]$, a good replacement $\hat{p} : \hat{C} \rightarrow B$ is given by the composite vertical morphism in the ordinary pullback diagram*

$$\begin{array}{ccc} \hat{C} & \longrightarrow & C \\ \downarrow & & \downarrow p \\ B^{\Delta[1]} & \longrightarrow & B \\ \downarrow & & \\ B & & \end{array}$$

where $B^{\Delta[1]}$ is the path object of B : the presheaf that is over each $U \in C$ the simplicial path space $B(U)^{\Delta[1]}$.

1.2.4.2.2 ∞ -Sheaves / ∞ -Stacks In particular, there is a notion of ∞ -presheaves on a category (or ∞ -category) C : ∞ -functors

$$X : C^{\text{op}} \rightarrow \infty\text{Grpd}$$

to the ∞ -category ∞Grpd of ∞ -groupoids – there is an ∞ -Yoneda embedding, and so on. Accordingly, ∞ -topos theory proceeds in its basic notions along the same lines as we sketched above for topos theory: an ∞ -topos of ∞ -sheaves is defined to be a reflective sub- ∞ -category

$$\text{Sh}_{(\infty,1)}(C) \begin{array}{c} \xleftarrow{L} \\ \xrightarrow{\quad} \end{array} \text{PSh}_{(\infty,1)}(C)$$

of an ∞ -category of ∞ -presheaves. As before, such is essentially determined by and determines a Grothendieck topology or coverage on C . Since a 2-sheaf with values in groupoids is usually called a *stack*, an ∞ -sheaf is often also called an ∞ -*stack*.

In the spirit of the above discussion, the objects of the ∞ -topos of ∞ -sheaves on $C = \text{CartSp}$ we shall think of as *smooth ∞ -groupoids*. This is our main running example. We shall write $\text{Smooth}\infty\text{Grpd} := \text{Sh}_{\infty}(\text{CartSp})$ for the ∞ -topos of smooth ∞ -groupoids.

Let

- $C := \text{SmthMfd}$ be the category of all smooth manifolds (or some other site, here assumed to have enough points);
- $\text{gSh}(C)$ be the category of groupoid-valued sheaves over C , for instance $X = \{ X \rightrightarrows X \}$, $\mathbf{BG} = \{ G \rightrightarrows * \} \in \text{gSh}(C)$;
- $\text{Ho}_{\text{gSh}(C)}$ the *homotopy category* obtained by universally turning the *stalkwise groupoid-equivalences* into isomorphisms.

Fact: $H^1(X, G) \simeq \text{Ho}_{\text{gSh}(C)}(X, \mathbf{BG})$. Let

- $\text{sSet}(C)_{\text{fib}} \hookrightarrow \text{Sh}(C, \text{sSet})$ be the stalkwise Kan simplicial sheaves;
- $L_W\text{sSh}(C)_{\text{fib}}$ the *simplicial localization* obtained by universally turning *stalkwise homotopy equivalences* into *homotopy equivalences*.

Definition/Theorem. This is the ∞ -category theory analog of the sheaf topos over C , the ∞ -*stack ∞ -topos*: $\mathbf{H} := \text{Sh}_{\infty}(C) \simeq L_W\text{sSh}(C)_{\text{fib}}$.

Example. $\text{Smooth}\infty\text{Grpd} := \text{Sh}_{\infty}(\text{SmthMfd})$ is the ∞ -topos of *smooth ∞ -groupoids*.

Proposition. Every object in $\text{Smooth}\infty\text{Grpd}$ is presented by a simplicial manifold, but not necessarily by a *locally Kan* simplicial manifold (see below).

But a crucial point of developing our theory in the language of ∞ -toposes is that all constructions work in great generality. By simply passing to another site C , all constructions apply to the theory of generalized spaces modeled on the test objects in C . Indeed, to really capture all aspects of ∞ -Lie theory, we should and will adjoin to our running example $C = \text{CartSp}$ that of the slightly larger site $C = \text{CartSp}_{\text{synthdiff}}$ of infinitesimally thickened Cartesian spaces. Ordinary sheaves on this site are the generalized spaces considered in *synthetic differential geometry*: these are smooth spaces such as smooth loci that may have infinitesimal extension. For instance the first order jet $D \subset \mathbb{R}$ of the origin in the real line exists as an infinitesimal space in $\text{Sh}(\text{CartSp}_{\text{synthdiff}})$. Accordingly, ∞ -groupoids modeled on $\text{CartSp}_{\text{synthdiff}}$ are smooth ∞ -groupoids that may have k -morphisms of infinitesimal extension. We will see that a smooth ∞ -groupoid all whose morphisms has infinitesimal extension is a Lie algebra or Lie algebroid or generally an ∞ -Lie algebroid.

While ∞ -category theory provides a good abstract definition and theory of ∞ -groupoids modeled on test objects in a category C in terms of the ∞ -category of ∞ -sheaves on C , for concrete manipulations it is often useful to have a presentation of the ∞ -categories in question in terms of generators and relations in ordinary category theory. Such a generators-and-relations-presentation is provided by the notion of a *model category* structure. Specifically, the ∞ -toposes of ∞ -presheaves that we are concerned with are presented in

this way by a model structure on simplicial presheaves, i.e. on the functor category $[C^{\text{op}}, \text{sSet}]$ from C to the category sSet of simplicial sets. In terms of this model, the corresponding ∞ -category of ∞ -sheaves is given by another model structure on $[C^{\text{op}}, \text{sSet}]$, called the *left Bousfield localization* at the set of covers in C .

These models for ∞ -stack ∞ -toposes have been proposed, known and studied since the 1970s and are therefore quite well understood. The full description and proof of their abstract role in ∞ -category theory was established in [L-Topos].

As before for toposes, there is an archetypical ∞ -topos, which is $\infty\text{Grpd} = \text{Sh}_{(\infty,1)}(*)$ itself: the collection of generalized ∞ -groupoids that are modeled on the point. All we know about these generalized spaces is how to map a point into them and what the homotopies and higher homotopies of such maps are, but no further extra structure. So these are bare ∞ -groupoids without extra structure. Also as before, every ∞ -topos comes with an essentially unique geometric morphism to this archetypical ∞ -topos given by a pair of adjoint ∞ -functors

$$\text{Sh}_{(\infty,1)}(C) \begin{array}{c} \xleftarrow{\text{Disc}} \\ \xrightarrow{\Gamma} \end{array} \infty\text{Grpd} .$$

Again, if C happens to have a terminal object $*$, then Γ is the operation that evaluates an ∞ -sheaf on the point: it produces the bare ∞ -groupoid underlying an ∞ -groupoid modeled on C . For instance for $C = \text{CartSp}$ a smooth ∞ -groupoid $X \in \text{Sh}_{(\infty,1)}(C)$ is sent by Γ to the underlying ∞ -groupoid that forgets the smooth structure on X .

Moreover, still in direct analogy to the 1-categorical case above, the left adjoint Disc is the ∞ -functor that sends a bare ∞ -groupoid S to the ∞ -stackification $\text{Disc}S = L\text{Const}S$ of the constant ∞ -presheaf on S . This models the discretely structured ∞ -groupoid on S . For instance for $C = \text{CartSp}$ we have that $\text{Disc}S$ is a smooth ∞ -groupoid with discrete smooth structure: all smooth families of points in it are actually constant.

1.2.4.2.3 Structured ∞ -Groups It is clear that we may speak of *group objects* in any topos, (or generally in any category with finite products): objects G equipped with a multiplication $G \times G \rightarrow G$ and a neutral element $* \rightarrow G$ such that the multiplication is unital, associative and has inverses for each element. In a sheaf topos, such a G is equivalently a *sheaf of groups*. For instance every Lie group canonically becomes a group object in $\text{Sh}(\text{CartSp})$.

As we pass to an ∞ -topos the situation is essentially the same, only that the associativity condition is replaced by *associativity up to coherent homotopy* (also called: up to *strong homotopy*), and similarly for the unitalness and the existence of inverses. One way to formalize this is to say that a group object in an ∞ -topos \mathbf{H} is an A_∞ -algebra object G such that its 0-truncation $\tau_0 G$ is a group object in the underlying 1-topos. (This is discussed in [L-Alg].)

For instance in the ∞ -topos over CartSp a Lie group still naturally is a group object, but also a *Lie 2-group* or *differentiable group stack* is. Moreover, every sheaf of *simplicial groups* presents a group object in the ∞ -topos, and we will see that all group objects here have a presentation by sheaves of simplicial groups.

A group object in $\infty\text{Grpd} \simeq \text{Top}$ we will for emphasis call an *∞ -group*. In this vein a group object in an ∞ -topos over a non-trivial site is a *structured ∞ -group* (for instance a topological ∞ -group or a smooth ∞ -group).

A classical source of ∞ -groups are *loop spaces*, where the group multiplication is given by concatenation of based loops in a given space, the homotopy-coherent associativity is given by reparameterizations of concatenations of loops, and inverses are given by reversing the parameterization of a loop. A classical result of Milnor says, in this language, that every ∞ -group arises as a loop space this way. This statement generalizes from discrete ∞ -groups (group objects in $\infty\text{Grpd} \simeq \text{Top}$) to structured ∞ -groups.

Theorem. (Milnor–Lurie) There is an equivalence

$$\{ \text{groups in } \mathbf{H} \} \begin{array}{c} \xleftarrow{\text{looping } \Omega} \\ \xrightarrow{\text{delooping } \mathbf{B}} \end{array} \left\{ \begin{array}{c} \text{pointed connected} \\ \text{objects in } \mathbf{H} \end{array} \right\}$$

This equivalence is a most convenient tool. In the following we will almost exclusively handle ∞ -groups G in terms of their pointed connected delooping objects \mathbf{BG} . We discuss this in more detail below in 3.6.8.

This is all the more useful as the objects $\mathbf{B}G$ happen to be the *moduli* ∞ -stacks of G -principal ∞ -bundles. We come to this in 1.2.5.5.

1.2.4.3 Cohomology Where the archetypical topos is the category \mathbf{Set} , the archetypical ∞ -topos is the ∞ -category $\infty\mathbf{Grpd}$ of ∞ -groupoids. This, in turn, is equivalent by a classical result (see 4.2) to \mathbf{Top} , the category of topological spaces, regarded as an ∞ -category by taking the 2-morphisms to be homotopies between continuous maps, 3-morphisms to be homotopies of homotopy, and so forth:

$$\infty\mathbf{Grpd} \simeq \mathbf{Top}.$$

In \mathbf{Top} it is familiar – from the notion of *classifying spaces* and from the *Brown representability theorem* (the reader in need of a review of such matter might try [May99]) – that the cohomology of a topological space X may be identified as the set of homotopy classes of continuous maps from X to some coefficient space A

$$H(X, A) := \pi_0 \mathbf{Top}(X, A).$$

For instance for $A = K(n, \mathbb{Z}) \simeq B^n \mathbb{Z}$ the topological space called the n th *Eilenberg-MacLane space* of the additive group of integers, we have that

$$H(X, A) := \pi_0 \mathbf{Top}(X, B^n \mathbb{Z}) \simeq H^n(X, \mathbb{Z})$$

is the ordinary integral (singular) cohomology of X . Also *nonabelian cohomology* is famously exhibited this way: for G a (possibly nonabelian) topological group and $A = BG$ its classifying space (we discuss this construction and its generalization in detail in 4.3.4.1) we have that

$$H(X, A) := \pi_0 \mathbf{Top}(X, BG) \simeq H^1(X, G)$$

is the degree-1 nonabelian cohomology of X with coefficients in G , which classifies G -principal bundles over X (more on that in a moment).

Since this only involves forming ∞ -categorical hom-spaces and since this is an entirely categorical operation, it makes sense to *define* for X, A any two objects in an arbitrary ∞ -topos \mathbf{H} the intrinsic cohomology of X with coefficients in A to be

$$H(X, A) := \pi_0 \mathbf{H}(X, A),$$

where $\mathbf{H}(X, A)$ denotes the ∞ -groupoid of morphism from X to A in \mathbf{H} . This general identification of cohomology with hom-spaces in ∞ -toposes is central to our developments here. We indicate now two classes of justification for this definition.

1. Essentially every notion of cohomology already considered in the literature is an example of this definition. Moreover, those that are not are often improved on by fixing them to become an example.
2. The use of a good notion of G -cohomology on X should be that it *classifies* “ G -structures over X ” and exhibits the *obstruction theory* for extensions or lifts of such structures. We find that it is precisely the context of an ambient ∞ -topos (precisely: the ∞ -Giraud axioms that characterize an ∞ -topos) that makes such a classification and obstruction theory work.

We discuss now a list of examples of ∞ -toposes \mathbf{H} together with notions of cohomology whose cocycles are given by morphisms $c \in \mathbf{H}(X, A)$ between a domain object X and coefficient object A in this ∞ -topos. Some of these examples are evident and classical, modulo our emphasis on the ∞ -topos theoretic perspective, others are original. Even those cases that are classical receive new information from the ∞ -topos theoretic perspective.

Details are below in the relevant parts of 4 and 5.

In view of the unification that we discuss, some of the traditional names for notions of cohomology are a bit suboptimal. For instance the term *generalized cohomology* for theories satisfying the Eilenberg-Steenrod

axioms does not well reflect that it is a generalization of ordinary cohomology of topological spaces (only) which is, in a quite precise sense, *orthogonal* to the generalizations given by passage to sheaf cohomology or to nonabelian cohomology, all of which are subsumed by cohomology in an ∞ -topos. In order to usefully distinguish the crucial aspects here we will use the following terminology

- We speak of *structured cohomology* to indicate that a given notion is realized in an ∞ -topos other than the archetypical $\infty\text{Grpd} \simeq \text{Top}$ (which represents “discrete structure” in the precise sense discussed in 4.2). Hence traditional sheaf cohomology is “structured” in this sense, while ordinary cohomology and Eilenberg-Steenrod cohomology is “unstructured”.
- We speak of *nonabelian cohomology* when coefficient objects are not *required* to be abelian (groups) or stable (spectra), but may generally be deloopings $A := \mathbf{B}G$ of arbitrary (structured) ∞ -groups G .

More properly this might be called *not-necessarily abelian cohomology*, but following common practice (as in “noncommutative geometry”) we stick with the slightly imprecise but shorter term. One point that we will dwell on (see the discussion of examples in 5.2) is that the traditional notion of *twisted cohomology* (already twisted abelian cohomology) is naturally a special case of nonabelian cohomology.

Notice that the “generalized” in “generalized cohomology” of Eilenberg-Steenrod type refers to allowing coefficient objects which are abelian ∞ -groups more general than Eilenberg-MacLane objects. Hence this is in particular subsumed in *nonabelian cohomology*.

In this terminology, the notion of cohomology in ∞ -toposes that we are concerned with here is *structured nonabelian/twisted generalized cohomology*.

Finally, not only is it natural to allow the coefficient objects A to be general objects in a general ∞ -topos, but also there is no reason to restrict the nature of the domain objects X . For instance traditional sheaf cohomology always takes X , in our language, to be the *terminal object* $X = *$ of the ambient ∞ -topos. This is also called the *(-2)-truncated object* (see 3.6.2 below) of the ∞ -topos, being the unique member of the lowest class in a hierarchy of *n-truncated objects* for $(-2) \leq n \leq \infty$. As we increase n here, we find that the domain object is generalized to

- $n = -1$: subspaces of X ;
- $n = 0$: étale spaces over X ;
- $n = 1$: orbifolds / orbispaces / groupoids over X ;
- $n \geq 2$: higher orbifolds / orbispaces / groupoids

One finds then that cohomology of an n -truncated object for $n \geq 1$ reproduces the traditional notion of *equivariant cohomology*. In particular this subsumes *group cohomology*: ordinary group cohomology in the unstructured case (in $\mathbf{H} = \infty\text{Grpd}$) and generally structured group cohomology such as *Lie group cohomology*.

Therefore, strictly speaking, we are here concerned with *equivariant structured nonabelian/twisted generalized cohomology*. All this is neatly encapsulated by just the fundamental notion of hom-spaces in ∞ -toposes.

Cochain cohomology

The origin and maybe the most elementary notion of cohomology is that appearing in *homological algebra*: given a *cochain complex* of abelian groups

$$V^\bullet = \left[\dots \xleftarrow{d^2} V^2 \xleftarrow{d^1} V^1 \xleftarrow{d^0} V^0 \right],$$

its cohomology group in degree n is defined to be the quotient group

$$H^n(V) := \ker(d^n) / \text{im}(d^{n-1}).$$

To see how this is a special case of cohomology in an ∞ -topos, consider a fixed abelian group A and suppose that this cochain complex is the A -dual of a *chain* complex

$$V_\bullet = \left[\cdots \longrightarrow V_2 \xrightarrow{\partial_2} V_1 \xrightarrow{\partial_1} V_0 \right],$$

in that $V^\bullet = \text{Hom}_{\text{Ab}}(V_\bullet, A)$. For instance if $A = \mathbb{Z}$ and V_n is the free abelian group on the set of n -simplices in some topological space, then V^n is the group of *singular n -cochains* on X .

Write then $A[n]$ (or $A[-n]$, if preferred) for the chain complex concentrated in degree n on A . In terms of this

1. morphisms of chain complexes $c : V_\bullet \rightarrow A[n]$ are in natural bijection with *closed* elements in V^n , hence with $\ker(d^n)$;
2. chain homotopies $\eta : c_1 \rightarrow c_2$ between two such chain morphisms are in natural bijection with elements in $\text{im}(d^{n-1})$.

This way the cohomology group $H^n(V^\bullet)$ is naturally identified with the *homotopy classes* of maps $V_\bullet \rightarrow A[n]$.

Consider then again an example as that of singular cochains as above, where V_\bullet is degreewise a free abelian group in a simplicial set X . Then this cohomology is the group of connected components of a hom-space in an ∞ -topos. To see this, one observes that the category of chain complexes Ch_\bullet is but a convenient presentation for the category of ∞ -groupoids that are equipped with *strict abelian group structure* in their incarnation as Kan complexes: simplicial abelian groups. This equivalence $\text{Ch}_\bullet \simeq \text{sAb}$ is known as the *Dold-Kan correspondence*, to be discussed in more detail in 2.2.6. We write $\Xi(V_\bullet)$ for the Kan complex corresponding to a chain complex under this equivalence. Moreover, for chain complexes of the form $A[n]$ we write

$$\mathbf{B}^n A := \Xi(A[n]).$$

With this notation, the ∞ -groupoid of chain maps $V_\bullet \rightarrow A[n]$ is equivalently that of ∞ -functors $X \rightarrow \mathbf{B}^n A$ and hence the cochain cohomology of V^\bullet is

$$H^n(V^\bullet) \simeq \pi_0 \mathbf{H}(X, \mathbf{B}^n A).$$

Lie group cohomology

There are some definitions in the literature of cohomology theories that are not special cases of this general concept, but in these cases it seems that the failure is with the traditional definition, not with the above notion. We will be interested in particular in the group cohomology of Lie groups. Originally this was defined using a naive direct generalization of the formula for bare group cohomology as

$$H_{\text{naive}}^n(G, A) = \{\text{smooth maps } G^{\times n} \rightarrow A\} / \sim.$$

But this definition was eventually found to be too coarse: there are structures that ought to be cocycles on Lie groups but do not show up in this definition. Graeme Segal therefore proposed a refined definition that was later rediscovered by Jean-Luc Brylinski, called *differentiable Lie group cohomology* $H_{\text{diffbl}}^n(G, A)$. This refines the naive Lie group cohomology in that there is a natural morphism $H_{\text{naive}}^n(G, A) \rightarrow H_{\text{diffbl}}^n(G, A)$.

But in the ∞ -topos of smooth ∞ -groupoids $\mathbf{H} = \text{Sh}_\infty(\text{CartSp})$ we have the natural intrinsic definition of Lie group cohomology as

$$H_{\text{Smooth}}^n(G, A) := \pi_0 \mathbf{H}(\mathbf{B}G, \mathbf{B}^n A)$$

and one finds that this naturally includes the Segal/Brylinski definition

$$H_{\text{naive}}^n(G, A) \rightarrow H_{\text{diffbl}}^n(G, A) \rightarrow H_{\text{Smooth}}^n(G, A) := \pi_0 \mathbf{H}(\mathbf{B}G, \mathbf{B}^n A).$$

and at least for A a discrete group, or the group of real numbers or a quotient of these such as $U(1) = \mathbb{R}/\mathbb{Z}$, the notions coincide

$$H_{\text{diffbl}}^n(G, A) \simeq H_{\text{Smooth}}^n(G, A).$$

Details on this discussion about refined Lie group cohomology are below in 4.4.6.2.

For instance one of the crucial aspects of the notion of cohomology is that a cohomology class on X *classifies* certain structures over X .

It is a classical fact that if G is a (discrete) group and BG its delooping in \mathbf{Top} , then the structure classified by a cocycle $g : X \rightarrow BG$ is the G -principal bundle over X obtained as the 1-categorical pullback $P \rightarrow X$

$$\begin{array}{ccc} P & \longrightarrow & EG \\ \downarrow & & \downarrow \\ X & \xrightarrow{g} & BG \end{array}$$

of the universal G -principal bundle $EG \rightarrow BG$. But one finds that this pullback construction is just a 1-categorical *model* for what intrinsically is something simpler: this is just the *homotopy pullback* in \mathbf{Top} of the point

$$\begin{array}{ccc} P & \longrightarrow & * \\ \downarrow & \swarrow \simeq & \downarrow \\ X & \xrightarrow{g} & BG \end{array}$$

This form of the construction of the G -principal bundle classified by a cocycle makes sense in any ∞ -topos \mathbf{H} :

We say that for $G \in \mathbf{H}$ a group object in \mathbf{H} and \mathbf{BG} its delooping and for $g : X \rightarrow \mathbf{BG}$ a cocycle (any morphism in \mathbf{H}) that the *G -principal ∞ -bundle* classified by g is the ∞ -pullback/homotopy pullback

$$\begin{array}{ccc} P & \longrightarrow & * \\ \downarrow & \swarrow \simeq & \downarrow \\ X & \xrightarrow{g} & \mathbf{BG} \end{array}$$

in \mathbf{H} . (Beware that usually we will notationally suppress the homotopy filling this square diagram.)

Let G be a Lie group and X a smooth manifold, both regarded naturally as objects in the ∞ -topos of smooth ∞ -groupoids. Let $g : X \rightarrow \mathbf{BG}$ be a morphism in \mathbf{H} . One finds that in terms of the presentation of $\mathbf{Smooth}\infty\mathbf{Grpd}$ by the model structure on simplicial presheaves this is a Čech 1-cocycle on X with values in G . The corresponding ∞ -pullback P is (up to equivalence or course) the smooth G -principal bundle classified in the usual sense by this cocycle.

The analogous proposition holds for G a Lie 2-group and P a G -principal 2-bundle.

Generally, we can give a natural definition of G -principal ∞ -bundle in any ∞ -topos \mathbf{H} over any ∞ -group object $G \in \mathbf{H}$. One finds that it is the Giraud axioms that characterize ∞ -toposes that ensure that these are equivalently classified as the ∞ -pullbacks of morphisms $g : X \rightarrow \mathbf{BG}$. Therefore the intrinsic cohomology

$$H(X, G) := \pi_0 \mathbf{H}(X, \mathbf{BG})$$

in \mathbf{H} classifies G -principal ∞ -bundles over X . Notice that X here may itself be any object in \mathbf{H} .

1.2.4.4 Homotopy Every ∞ -sheaf ∞ -topos \mathbf{H} canonically comes equipped with a geometric morphism given by pair of adjoint ∞ -functors

$$(L\mathbf{Const} \dashv \Gamma) : \mathbf{H} \begin{array}{c} \xleftarrow{L\mathbf{Const}} \\ \xrightarrow{\Gamma} \end{array} \infty\mathbf{Grpd}$$

relating it to the archeotypical ∞ -topos of ∞ -groupoids. Here Γ produces the global sections of an ∞ -sheaf and $L\mathbf{Const}$ produces the constant ∞ -sheaf on a given ∞ -groupoid.

In the cases that we are interested in here \mathbf{H} is a big topos of ∞ -groupoids equipped with cohesive structure, notably equipped with smooth structure in our motivating example. In this case Γ has the interpretation of sending a cohesive ∞ -groupoid $X \in \mathbf{H}$ to its underlying ∞ -groupoid, after forgetting the cohesive structure, and $L\text{Const}$ has the interpretation of forming ∞ -groupoids equipped with discrete cohesive structure. We shall write $\text{Disc} := L\text{Const}$ to indicate this.

But in these cases of cohesive ∞ -toposes there are actually more adjoints to these two functors, and this will be essentially the general abstract definition of cohesiveness. In particular there is a further left adjoint

$$\Pi : \mathbf{H} \rightarrow \infty\text{Grpd}$$

to Disc : the *fundamental ∞ -groupoid functor on a locally ∞ -connected ∞ -topos*. Following the standard terminology of *locally connected toposes* in ordinary topos theory we shall say that \mathbf{H} with such a property is a *locally ∞ -connected ∞ -topos*. This terminology reflects the fact that if X is a locally contractible topological space then $\mathbf{H} = \text{Sh}_\infty(X)$ is a locally contractible ∞ -topos. A classical result of Artin-Mazur implies, that in this case the value of Π on $X \in \text{Sh}_\infty(X)$ is, up to equivalence, the *fundamental ∞ -groupoid of X* :

$$\Pi : (X \in \text{Sh}_\infty(X)) \mapsto (\text{Sing } X \in \infty\text{Grpd}),$$

which is the ∞ -groupoid whose

- objects are the points of X ;
- morphisms are the (continuous) paths in X ;
- 2-morphisms are the continuous homotopies between such paths;
- k -morphisms are the higher order homotopies between $(k - 1)$ -dimensional paths.

This is the object that encodes all the homotopy groups of X in a canonical fashion, without choice of fixed base point.

Also the big ∞ -topos $\text{Smooth}\infty\text{Grpd} = \text{Sh}_\infty(\text{CartSp})$ turns out to be locally ∞ -connected

$$(\Pi \dashv \text{Disc} \dashv \Gamma) : \text{Smooth}\infty\text{Grpd} \begin{array}{c} \xrightarrow{\Pi} \\ \xleftarrow{\text{Disc}} \\ \xrightarrow{\Gamma} \end{array} \infty\text{Grpd}$$

as a reflection of the fact that every Cartesian space $\mathbb{R}^n \in \text{CartSp}$ is contractible as a topological space. We find that for X any paracompact smooth manifold, regarded as an object of $\text{Smooth}\infty\text{Grpd}$, again $\Pi(X) \in \text{Smooth}\infty\text{Grpd}$ is the corresponding fundamental ∞ -groupoid. More in detail, under the *homotopy-*

hypothesis-equivalence $(|-| \dashv \text{Sing}) : \text{Top} \begin{array}{c} \xleftarrow{|-|} \\ \xrightarrow{\simeq} \\ \xrightarrow{\text{Sing}} \end{array} \infty\text{Grpd}$ we have that the composite

$$|\Pi(-)| : \mathbf{H} \xrightarrow{\Pi} \infty\text{Grpd} \xrightarrow{|-|} \text{Top}$$

sends a smooth manifold X to its homotopy type: the underlying topological space of X , up to weak homotopy equivalence.

Analogously, for a general object $X \in \mathbf{H}$ we may think of $|\Pi(X)|$ as the generalized geometric realization in Top . For instance we find that if $X \in \text{Smooth}\infty\text{Grpd}$ is presented by a simplicial paracompact manifold, then $|\Pi(X)|$ is the ordinary geometric realization of the underlying simplicial topological space of X . This means in particular that for $X \in \text{Smooth}\infty\text{Grpd}$ a Lie groupoid, $\Pi(X)$ computes its *homotopy groups of a Lie groupoid* as traditionally defined.

The ordinary homotopy groups of $\Pi(X)$ or equivalently of $|\Pi(X)|$ we call the *geometric homotopy groups* of $X \in \mathbf{H}$, because these are based on a notion of homotopy induced by an intrinsic notion of geometric paths in objects in X . This is to be contrasted with the *categorical homotopy groups* of X . These are the

homotopy groups of the underlying ∞ -groupoid $\Gamma(X)$ of X . For instance for X a smooth manifold we have that

$$\pi_n(\Gamma(X)) \simeq \begin{cases} X \in \text{Set} & |n = 0 \\ 0 & |n > 0 \end{cases}$$

but

$$\pi_n(\Pi(X)) \simeq \pi_n(X \in \text{Top}).$$

This allows us to give a precise sense to what it means to have a *cohesive refinement* (continuous refinement, smooth refinement, etc.) of an object in Top . Notably we are interested in smooth refinements of classifying spaces $BG \in \text{Top}$ for topological groups G by deloopings $\mathbf{B}G \in \text{Smooth}\infty\text{Grpd}$ of ∞ -Lie groups G and we may interpret this as saying that

$$\Pi(\mathbf{B}G) \simeq BG$$

in $\text{Top} \simeq \text{Smooth}\infty\text{Grpd}$.

1.2.5 Principal bundles

The following is an exposition of the notion of *principal bundles* in higher but low degree.

We assume here that the reader has a working knowledge of groupoids and at least a rough idea of 2-groupoids. For introductions see for instance [BrHiSi11] [Por]

Below in 1.2.5.4 a discussion of the formalization of ∞ -groupoids in terms of Kan complexes is given and is used to present a systematic way to understand these constructions in all degrees.

1.2.5.1 Principal 1-bundles Let G be a Lie group and X a smooth manifold (all our smooth manifolds are assumed to be finite dimensional and paracompact). We give a discussion of smooth G -principal bundles on X in a manner that paves the way to a straightforward generalization to a description of principal ∞ -bundles. From X and G are naturally induced certain Lie groupoids.

From the group G we canonically obtain a groupoid that we write BG and call the *delooping groupoid* of G . Formally this groupoid is

$$BG = (G \rightrightarrows *)$$

with composition induced from the product in G . A useful depiction of this groupoid is

$$BG = \left\{ \begin{array}{ccc} & * & \\ g_1 \nearrow & & \searrow g_2 \\ * & \xrightarrow{g_2 \cdot g_1} & * \end{array} \right\},$$

where the $g_i \in G$ are elements in the group, and the bottom morphism is labeled by forming the product in the group. (The order of the factors here is a convention whose choice, once and for all, does not matter up to equivalence.)

But we get a bit more, even. Since G is a Lie group, there is smooth structure on BG that makes it a Lie groupoid, an internal groupoid in the category SmoothMfd of smooth manifolds: its collection of objects (trivially) and of morphisms each form a smooth manifold, and all structure maps (source, target, identity, composition) are smooth functions. We shall write

$$\mathbf{B}G \in \text{LieGrpd}$$

for BG regarded as equipped with this smooth structure. Here and in the following the boldface is to indicate that we have an object equipped with a bit more structure – here: smooth structure – than present on the object denoted by the same symbols, but without the boldface. Eventually we will make this precise by having the boldface symbols denote objects in the ∞ -topos $\text{Smooth}\infty\text{Grpd}$ which are taken by a suitable functor to objects in ∞Grpd denoted by the corresponding non-boldface symbols.

Also the smooth manifold X may be regarded as a Lie groupoid - a groupoid with only identity morphisms. Its depiction is simply

$$X = \{ x \xrightarrow{\text{Id}} x \}$$

for all $x \in X$. But there are other groupoids associated with X : let $\{U_i \rightarrow X\}_{i \in I}$ be an open cover of X . To this is canonically associated the Čech-groupoid $C(\{U_i\})$. Formally we may write this groupoid as

$$C(\{U_i\}) = \left\{ \coprod_{i,j} U_i \cap U_j \rightrightarrows \coprod_i U_i \right\}.$$

A useful depiction of this groupoid is

$$C(\{U_i\}) = \left\{ \begin{array}{ccc} & (x, j) & \\ \nearrow & & \searrow \\ (x, i) & \xrightarrow{\quad} & (x, k) \end{array} \right\},$$

This indicates that the objects of this groupoid are pairs (x, i) consisting of a point $x \in X$ and a patch $U_i \subset X$ that contains x , and a morphism is a triple (x, i, j) consisting of a point and two patches, that both contain the point, in that $x \in U_i \cap U_j$. The triangle in the above depiction symbolizes the evident way in which these morphisms compose. All this inherits a smooth structure from the fact that the U_i are smooth manifolds and the inclusions $U_i \hookrightarrow X$ are smooth functions. Hence also $C(\{U_i\})$ becomes a Lie groupoid.

There is a canonical projection functor

$$C(\{U_i\}) \rightarrow X : (x, i) \mapsto x.$$

This functor is an internal functor in SmoothMfd and moreover it is evidently essentially surjective and full and faithful. However, while essential surjectivity and full-and-faithfulness implies that the underlying bare functor has a homotopy-inverse, that homotopy-inverse never has itself smooth component maps, unless X itself is a Cartesian space and the chosen cover is trivial.

We do however want to think of $C(\{U_i\})$ as being equivalent to X even as a Lie groupoid. One says that a smooth functor whose underlying bare functor is an equivalence of groupoids is a *weak equivalence* of Lie groupoids, which we write as $C(\{U_i\}) \xrightarrow{\simeq} X$. Moreover, we shall think of $C(\{U_i\})$ as a *good* equivalent replacement of X if it comes from a cover that is in fact a *good open cover* in that all its non-empty finite intersections $U_{i_0, \dots, i_n} := U_{i_0} \cap \dots \cap U_{i_n}$ are diffeomorphic to the Cartesian space $\mathbb{R}^{\dim X}$.

We shall discuss later in which precise sense this condition makes $C(\{U_i\})$ *good* in the sense that smooth functors out of $C(\{U_i\})$ model the correct notion of morphism out of X in the context of smooth groupoids (namely it will mean that $C(\{U_i\})$ is cofibrant in a suitable model category structure on the category of Lie groupoids). The formalization of this statement is what ∞ -topos theory is all about, to which we will come. For the moment we shall be content with accepting this as an ad hoc statement.

Observe that a functor

$$g : C(\{U_i\}) \rightarrow \mathbf{BG}$$

is given in components precisely by a collection of smooth functions

$$\{g_{ij} : U_{ij} \rightarrow G\}_{i,j \in I}$$

such that on each $U_i \cap U_j \cap U_k$ the equality $g_{jk}g_{ij} = g_{ik}$ of functions holds.

It is well known that such collections of functions characterize G -principal bundles on X . While this is a classical fact, we shall now describe a way to derive it that is true to the Lie-groupoid-context and that will make clear how smooth principal ∞ -bundles work.

First observe that in total we have discussed so far spans of smooth functors of the form

$$\begin{array}{ccc} C(\{U_i\}) & \xrightarrow{g} & \mathbf{BG} \\ \downarrow \simeq & & \\ X & & \end{array} .$$

Such spans of functors, whose left leg is a weak equivalence, are sometimes known, essentially equivalently, as *Morita morphisms*, as *generalized morphisms* of Lie groupoids, as *Hilsum-Skandalis morphisms*, or as *groupoid bibundles* or as *anafunctors*. We are to think of these as concrete models for more intrinsically defined direct morphisms $X \rightarrow \mathbf{BG}$ in the ∞ -topos of smooth ∞ -groupoids.

Now consider yet another Lie groupoid canonically associated with G : we shall write \mathbf{EG} for the groupoid – the *smooth universal G -bundle* – whose formal description is

$$\mathbf{EG} = \left(G \times G \begin{array}{c} \xrightarrow{(-)\cdot(-)} \\ \xrightarrow{p_1} \end{array} G \right)$$

with the evident composition operation. The depiction of this groupoid is

$$\left\{ \begin{array}{ccc} & g_2 & \\ g_2 g_1^{-1} \nearrow & & \searrow g_3 g_2^{-1} \\ g_1 & \xrightarrow{g_3 g_1^{-1}} & g_3 \end{array} \right\} ,$$

This again inherits an evident smooth structure from the smooth structure of G and hence becomes a Lie groupoid.

There is an evident forgetful functor

$$\mathbf{EG} \rightarrow \mathbf{BG}$$

which sends

$$(g_1 \rightarrow g_2) \mapsto (\bullet \xrightarrow{g_2 g_1^{-1}} \bullet) .$$

Consider then the pullback diagram

$$\begin{array}{ccc} \tilde{P} & \longrightarrow & \mathbf{EG} \\ \downarrow & & \downarrow \\ C(\{U_i\}) & \xrightarrow{g} & \mathbf{BG} \\ \downarrow \simeq & & \\ X & & \end{array}$$

in the category $\text{Grpd}(\text{SmoothMfd})$. The object \tilde{P} is the Lie groupoid whose depiction is

$$\tilde{P} = \left\{ (x, i, g_1) \longrightarrow (x, j, g_2 = g_{ij}(x)g_1) \right\} ;$$

where there is a unique morphism as indicated, whenever the group labels match as indicated. Due to this uniqueness, this Lie groupoid is weakly equivalent to one that comes just from a manifold P (it is 0-truncated)

$$\tilde{P} \xrightarrow{\simeq} P .$$

This P is traditionally written as

$$P = \left(\coprod_i U_i \times G \right) / \sim,$$

where the equivalence relation is precisely that exhibited by the morphisms in \tilde{P} . This is the traditional way to construct a G -principal bundle from cocycle functions $\{g_{ij}\}$. We may think of \tilde{P} as *being* P . It is a particular representative of P in the ∞ -topos of Lie groupoids.

While it is easy to see in components that the P obtained this way does indeed have a principal G -action on it, for later generalizations it is crucial that we can also recover this in a general abstract way. For notice that there is a canonical action

$$(\mathbf{E}G) \times G \rightarrow \mathbf{E}G,$$

given by the group action on the space of objects. Then consider the pasting diagram of pullbacks

$$\begin{array}{ccc} \tilde{P} \times G & \longrightarrow & \mathbf{E}G \times G \\ \downarrow & & \downarrow \\ \tilde{P} & \longrightarrow & \mathbf{E}G \\ \downarrow & & \downarrow \\ C(U) & \xrightarrow{g} & \mathbf{B}G \\ \downarrow \simeq & & \\ X & & \end{array}$$

Here the morphism $\tilde{P} \times G \rightarrow \tilde{P}$ exhibits the principal G -action of G on \tilde{P} .

In summary we find the following

Observation 1.2.69. For $\{U_i \rightarrow X\}$ a good open cover, there is an equivalence of categories

$$\text{SmoothFunc}(C(\{U_i\}), \mathbf{B}G) \simeq \text{GBund}(X)$$

between the functor category of smooth functors and smooth natural transformations, and the groupoid of smooth G -principal bundles on X .

It is no coincidence that this statement looks akin to the maybe more familiar statement which says that equivalence classes of G -principal bundles are classified by homotopy-classes of morphisms of topological spaces

$$\pi_0 \text{Top}(X, \mathbf{B}G) \simeq \pi_0 \text{GBund}(X),$$

where $\mathbf{B}G \in \text{Top}$ is the topological classifying space of G . What we are seeing here is a first indication of how cohomology of bare ∞ -groupoids is lifted inside a richer ∞ -topos to cohomology of ∞ -groupoids with extra structure.

In fact, all of the statements that we considered so far becomes conceptually simpler in the ∞ -topos. We had already remarked that the anafunctor $\text{span } X \xleftarrow{\tilde{c}} C(\{U_i\}) \xrightarrow{g} \mathbf{B}G$ is really a model for what is simply a direct morphism $X \rightarrow \mathbf{B}G$ in the ∞ -topos. But more is true: that pullback of $\mathbf{E}G$ which we considered is just a model for the homotopy pullback of just the *point*

$$\begin{array}{ccc}
\vdots & \vdots & \vdots \quad \vdots \\
\tilde{P} \times G & \longrightarrow & \mathbf{E}G \times G \\
\downarrow & & \downarrow \\
\tilde{P} & \longrightarrow & \mathbf{E}G \\
\downarrow & & \downarrow \\
C(U) & \xrightarrow{g} & \mathbf{B}G \\
\downarrow \simeq & & \\
X & & \\
\text{in the model category} & & \text{in the } \infty\text{-topos}
\end{array}
\quad
\begin{array}{ccc}
P \times G & \longrightarrow & G \\
\downarrow & \swarrow \simeq & \downarrow \\
P & \longrightarrow & * \\
\downarrow & \swarrow \simeq & \downarrow \\
X & \xrightarrow{g} & \mathbf{B}G
\end{array}$$

The traditional statement which identifies the classifying topological space BG as the quotient of the contractible EG by the free G -action

$$BG \simeq EG/G$$

becomes after the refinement to smooth groupoids the statement that $\mathbf{B}G$ is the *homotopy quotient* of G acting on the point:

$$\mathbf{B}G \simeq *//G.$$

Generally:

Definition 1.2.70. For V a smooth manifold equipped with a smooth action by G (not necessarily free), the *action groupoid* $V//G$ is the Lie groupoid whose space of objects is V , and whose morphisms are group elements that connect two points (which may coincide) in V .

$$V//G = \left\{ v_1 \xrightarrow{g} v_2 \mid v_2 = g(v_1) \right\}.$$

Such an action groupoid is canonically equipped with a morphism to $\mathbf{B}G \simeq *//G$ obtained by sending all objects to the single object and acting as the identity on morphisms. Below in 3.6.13 we discuss that the sequence

$$V \rightarrow V//G \rightarrow \mathbf{B}G$$

entirely encodes the action of G on V . Also we will see in 5.2.2 that the morphism $V//G \rightarrow \mathbf{B}G$ is the smooth refinement of the V -bundle which is *associated to the universal G -bundle* via the given action. If V is a vector space acted on linearly, then this is an associated vector bundle. Its pullbacks along anafunctors $X \rightarrow \mathbf{B}G$ yield all V -vector bundles on X .

1.2.5.2 Principal 2-bundles and twisted 1-bundles The discussion above of G -principal bundles was all based on the Lie groupoids $\mathbf{B}G$ and $\mathbf{E}G$ that are canonically induced by a Lie group G . We now discuss the case where G is generalized to a *Lie 2-group*. The above discussion will go through essentially verbatim, only that we pick up 2-morphisms everywhere. This is the first step towards higher Chern-Weil theory. The resulting generalization of the notion of principal bundle is that of *principal 2-bundle*. For historical reasons these are known in the literature often as *gerbes* or as *bundle gerbes*, even though strictly speaking there are some conceptual differences.

Write $U(1) = \mathbb{R}/\mathbb{Z}$ for the circle group. We have already seen above the groupoid $\mathbf{B}U(1)$ obtained from this. But since $U(1)$ is an abelian group this groupoid has the special property that it still has itself the structure of a group object. This makes it what is called a *2-group*. Accordingly, we may form its delooping once more to arrive at a Lie 2-groupoid $\mathbf{B}^2U(1)$. Its depiction is

$$\mathbf{B}^2U(1) = \left\{ \begin{array}{ccc} & * & \\ \text{Id} \nearrow & & \searrow \text{Id} \\ * & \Downarrow g & * \\ & \text{Id} & \end{array} \right\}$$

for $g \in U(1)$. Both horizontal composition as well as vertical composition of the 2-morphisms is given by the product in $U(1)$.

Let again X be a smooth manifold with good open cover $\{U_i \rightarrow X\}$. The corresponding Čech groupoid we may also think of as a Lie 2-groupoid,

$$C(U) = \left(\coprod_{i,j,k} U_i \cap U_j \cap U_k \rightrightarrows \coprod_{i,j} U_i \cap U_j \rightrightarrows \coprod_i U_i \right).$$

What we see here are the first stages of the full *Čech nerve* of the cover. Eventually we will be looking at this object in its entirety, since for all degrees this is always a *good* replacement of the manifold X , as long as $\{U_i \rightarrow X\}$ is a good open cover. So we look now at 2-anafunctors given by spans

$$\begin{array}{ccc} C(\{U_i\}) & \xrightarrow{g} & \mathbf{B}^2U(1) \\ \downarrow \simeq & & \\ X & & \end{array}$$

of internal 2-functors. These will model direct morphisms $X \rightarrow \mathbf{B}^2U(1)$ in the ∞ -topos. It is straightforward to read off the following

Observation 1.2.71. A smooth 2-functor $g : C(\{U_i\}) \rightarrow \mathbf{B}^2U(1)$ is given by the data of a 2-cocycle in the Čech cohomology of X with coefficients in $U(1)$.

Because on 2-morphisms it specifies an assignment

$$g : \left\{ \begin{array}{ccc} & (x, j) & \\ \nearrow & & \searrow \\ (x, i) & \longrightarrow & (x, k) \end{array} \right\} \mapsto \left\{ \begin{array}{ccc} & * & \\ \text{Id} \nearrow & & \searrow \text{Id} \\ * & \Downarrow g_{ijk}(x) & * \\ & \text{Id} & \end{array} \right\}$$

that is given by a collection of smooth functions

$$(g_{ijk} : U_i \cap U_j \cap U_k \rightarrow U(1)).$$

On 3-morphisms it gives a constraint on these functions, since there are only identity 3-morphisms in $\mathbf{B}^2U(1)$:

$$\left(\left(\begin{array}{ccc} (x, j) & \longrightarrow & (x, k) \\ \uparrow & \nearrow & \downarrow \\ (x, i) & \longrightarrow & (x, l) \end{array} \right) \Rightarrow \left(\begin{array}{ccc} (x, j) & \longrightarrow & (x, k) \\ \uparrow & \searrow & \downarrow \\ (x, i) & \longrightarrow & (x, l) \end{array} \right) \right) \mapsto \left(\left(\begin{array}{ccc} * & \longrightarrow & * \\ \uparrow & \searrow g_{ijk}(x) & \downarrow \\ * & \longrightarrow & * \\ \uparrow & \nearrow g_{ikl}(x) & \downarrow \\ * & \longrightarrow & * \end{array} \right) = \left(\begin{array}{ccc} * & \longrightarrow & * \\ \uparrow & \searrow g_{jkl}(x) & \downarrow \\ * & \longrightarrow & * \\ \uparrow & \nearrow g_{ijl}(x) & \downarrow \\ * & \longrightarrow & * \end{array} \right) \right).$$

This relation

$$g_{ijk} \cdot g_{ikl} = g_{ijl} \cdot g_{jkl}$$

defines degree-2 cocycles in Čech cohomology with coefficients in $U(1)$.

In order to find the circle principal 2-bundle classified by such a cocycle by a pullback operation as before, we need to construct the 2-functor $\mathbf{EBU}(1) \rightarrow \mathbf{B}^2U(1)$ that exhibits the universal principal 2-bundle over $U(1)$. The right choice for $\mathbf{EBU}(1)$ – which we justify systematically in 1.2.5.4 – is indicated by

$$\mathbf{EBU}(1) = \left\{ \begin{array}{ccc} & * & \\ c_1 \nearrow & & \searrow c_2 \\ & \Downarrow g & \\ * & \xrightarrow{c_3 = g c_2 c_1} & * \end{array} \right\}$$

for $c_1, c_2, c_3, g \in U(1)$, where all possible composition operations are given by forming the product of these labels in $U(1)$. The projection $\mathbf{EBU}(1) \rightarrow \mathbf{B}^2U(1)$ is the obvious one that simply forgets the labels c_i of the 1-morphisms and just remembers the labels g of the 2-morphisms.

Definition 1.2.72. With $g : C(\{U_i\}) \rightarrow \mathbf{B}^2U(1)$ a Čech cocycle as above, the $U(1)$ -principal 2-bundle or circle 2-bundle that it defines is the pullback

$$\begin{array}{ccc} \tilde{P} & \longrightarrow & \mathbf{EBU}(1) \\ \downarrow & & \downarrow \\ C(\{U_i\}) & \xrightarrow{g} & \mathbf{B}^2U(1) \\ \simeq \downarrow & & \\ X & & \end{array}$$

Unwinding what this means, we see that \tilde{P} is the 2-groupoid whose objects are that of $C(\{U_i\})$, whose morphisms are finite sequences of morphisms in $C(\{U_i\})$, each equipped with a label $c \in U(1)$, and whose 2-morphisms are generated from those that look like

$$\begin{array}{ccc} & (x, j) & \\ c_1 \nearrow & & \searrow c_2 \\ (x, i) & \xrightarrow{c_3} & (x, k) \\ & \Downarrow g_{ijk}(x) & \end{array}$$

subject to the condition that

$$c_1 \cdot c_2 = c_3 \cdot g_{ijk}(x)$$

in $U(1)$. As before for principal 1-bundles P , where we saw that the analogous pullback 1-groupoid \tilde{P} was equivalent to the 0-groupoid P , here we see that this 2-groupoid is equivalent to the 1-groupoid

$$P = \left(C(U)_1 \times U(1) \rightrightarrows C(U) \right)$$

with composition law

$$((x, i) \xrightarrow{c_1} (x, j) \xrightarrow{c_2} (x, k)) = ((x, i) \xrightarrow{c_1 \cdot c_2 \cdot g_{ijk}(x)} (x, k)).$$

This is a groupoid central extension

$$\mathbf{BU}(1) \rightarrow P \rightarrow C(\{U_i\}) \simeq X.$$

Centrally extended groupoids of this kind are known in the literature as *bundle gerbes* (over the surjective submersion $Y = \coprod_i U_i \rightarrow X$). They may equivalently be thought of as given by a line bundle

$$\begin{array}{ccc} & L & \\ & \downarrow & \\ (C(U))_1 = \coprod_{i,j} U_i \cap U_j & \longrightarrow & (C(U))_0 = \coprod_i U_i \\ & & \downarrow \\ & & X \end{array}$$

over the space $C(U)_1$ of morphisms, and a line bundle morphism

$$\mu_g : \pi_1^* L \otimes \pi_2^* L \rightarrow \pi_1^* L$$

that satisfies an evident associativity law, equivalent to the cocycle condition on g . In summary we find that:

Observation 1.2.73. Bundle gerbes are presentations of Lie groupoids that are total spaces of $\mathbf{BU}(1)$ -principal 2-bundles, def. 1.2.72.

Notice that, even though there is a close relation, the notion of *bundle gerbe* is different from the original notion of *$U(1)$ -gerbe*. This point we discuss in more detail below in 1.2.85 and more abstractly in 4.3.10.

This discussion of *circle 2-bundles* has a generalization to 2-bundles that are principal over more general 2-groups.

Definition 1.2.74. 1. A smooth *crossed module* of Lie groups is a pair of homomorphisms $\partial : G_1 \rightarrow G_0$ and $\rho : G_0 \rightarrow \text{Aut}(G_1)$ of Lie groups, such that for all $g \in G_0$ and $h, h_1, h_2 \in G_1$ we have $\rho(\partial h_1)(h_2) = h_1 h_2 h_1^{-1}$ and $\partial \rho(g)(h) = g \partial(h) g^{-1}$.

2. For $(G_1 \rightarrow G_0)$ a smooth crossed module, the corresponding *strict Lie 2-group* is the smooth groupoid $G_0 \times G_1 \rightrightarrows G_0$, whose source map is given by projection on G_0 , whose target map is given by applying ∂ to the second factor and then multiplying with the first in G_0 , and whose composition is given by multiplying in G_1 .

This groupoid has a strict monoidal structure with strict inverses given by equipping $G_0 \times G_1$ with the semidirect product group structure $G_0 \ltimes G_1$ induced by the action ρ of G_0 on G_1 .

3. The corresponding one-object strict smooth 2-groupoid we write $\mathbf{B}(G_1 \rightarrow G_0)$. As a simplicial object (under the Duskin nerve of 2-categories) this is of the form

$$\mathbf{B}(G_1 \rightarrow G_0) = \text{cosk}_3 \left(G_0^{\times 3} \times G_1^{\times 3} \begin{array}{c} \rightrightarrows \\ \rightrightarrows \\ \rightrightarrows \end{array} G_0^{\times 2} \times G_1 \begin{array}{c} \rightrightarrows \\ \rightrightarrows \end{array} G_0 \longrightarrow * \right).$$

The infinitesimal analog of a crossed module of groups is a *differential crossed module*.

Definition 1.2.75. A *differential crossed module* is a chain complex of vector space of length 2 $V_1 \rightarrow V_0$ equipped with the structure of a dg-Lie algebra.

Example 1.2.76. For $G_1 \rightarrow G_0$ a smooth crossed module of Lie groups, differentiation of all structure maps yields a corresponding differential crossed module $\mathfrak{g}_1 \rightarrow \mathfrak{g}_0$.

Observation 1.2.77. For $G := [G_1 \xrightarrow{\partial} G_0]$ a crossed module, the 2-groupoid delooping a 2-group coming from a crossed module is of the form

$$\mathbf{BG} = \left\{ \begin{array}{c} \begin{array}{ccc} & * & \\ g_1 \nearrow & & \searrow g_2 \\ * & \Downarrow k & * \\ & \xrightarrow{\delta(k)g_2 \cdot g_1} & \end{array} & \Big| & g_1, g_2 \in G_0, k \in G_1 \end{array} \right\},$$

where the 3-morphisms – the composition identities – are

$$\left(\begin{array}{ccc} * & \xrightarrow{g_2} & * \\ \uparrow g_1 & \swarrow h_1 & \downarrow g_3 \\ * & \xrightarrow{\quad} & * \\ & \searrow h_2 & \\ & & * \end{array} \right) \xrightarrow{h_2 \cdot \rho(g_3)(h_1) = h_4 \cdot h_3} \left(\begin{array}{ccc} * & \xrightarrow{g_2} & * \\ \uparrow g_1 & \swarrow h_4 & \downarrow g_3 \\ * & \xrightarrow{\quad} & * \\ & \searrow h_3 & \\ & & * \end{array} \right)$$

Remark 1.2.78. All ingredients here are functorial, so that the above statements hold for presheaves over sites, hence in particular for cohesive 2-groups such as smooth 2-groups. Below in corollary 3.6.133 it is shown that every cohesive 2-group has a presentation by a crossed module this way.

Notice that there are different equivalent conventions possible for how to present \mathbf{BG} in terms of the corresponding crossed module, given by the choices of order in the group products. Here we are following convention “LB” in [RoSc08].

Example 1.2.79 (shift of abelian Lie group). For K an abelian Lie group then \mathbf{BK} is the delooping 2-group coming from the crossed module $[K \rightarrow 1]$ and \mathbf{BBK} is the 2-group coming from the complex $[K \rightarrow 1 \rightarrow 1]$.

Example 1.2.80 (automorphism 2-group). For H any Lie group with automorphism Lie group $\text{Aut}(H)$, the morphism $H \xrightarrow{\text{Ad}} \text{Aut}(H)$ that sends group elements to inner automorphisms, together with $\rho = \text{id}$, is a crossed module. We write $\text{AUT}(H) := (H \rightarrow \text{Aut}(H))$ and speak of the *automorphism 2-group* of H .

Example 1.2.81. The inclusion of any normal subgroup $N \hookrightarrow G$ with conjugation action of G on N is a crossed module, with the canonical induced conjugation action of G on N .

Example 1.2.82 (string 2-group). For G a compact, simple and simply connected Lie group, write PG for the smooth group of based paths in G and $\hat{\Omega}G$ for the universal central extension of the smooth group of based loops. Then the evident morphism $(\hat{\Omega}G \rightarrow PG)$ equipped with a lift of the adjoint action of paths on loops is a crossed module [BCSS07]. The corresponding strict 2-group is (a presentation of what is) called the *string 2-group* extension of G . The string 2-group we discuss in detail in 5.1.10.

It follows immediately that

Observation 1.2.83. For $G = (G_1 \rightarrow G_0)$ a 2-group coming from a crossed module, a cocycle

$$X \xrightarrow{\sim} C(U_i) \xrightarrow{g} \mathbf{BG}$$

is given by data

$$\{h_{ij} \in C^\infty(U_{ij}, G_0), g_{ijk} \in C^\infty(U_{ijk}, G_1)\}$$

such that on each U_{ijk} we have

$$h_{ik} = \delta(h_{ijk})h_{jk}h_{ij}$$

and on each U_{ijkl} we have

$$g_{ikl} \cdot \rho(h_{jk})(g_{ijk}) = g_{ijk} \cdot g_{jkl}.$$

Because under the above correspondence between crossed modules and 2-groups, this is the data that encodes assignments

$$g : \left\{ \begin{array}{ccc} & (x, j) & \\ \nearrow & \Downarrow & \searrow \\ (x, i) & \xrightarrow{\quad} & (x, k) \end{array} \right\} \mapsto \left\{ \begin{array}{ccc} & * & \\ \nearrow h_{ij}(x) & \Downarrow g_{ijk}(x) & \searrow h_{jk}(x) \\ * & \xrightarrow{h_{ik}(x)} & * \end{array} \right\}$$

that satisfy

$$\left(\begin{array}{ccc} * & \xrightarrow{h_{jk}} & * \\ \uparrow h_{ij} & \searrow g_{ijk} & \downarrow h_{kl} \\ * & & * \\ \downarrow & \nearrow g_{ikl} & \downarrow \\ * & \xrightarrow{\quad} & * \end{array} \right) \longrightarrow \left(\begin{array}{ccc} * & \xrightarrow{h_{jk}} & * \\ \uparrow h_{ij} & \searrow g_{ijl} & \downarrow h_{kl} \\ * & & * \\ \downarrow & \nearrow g_{jkl} & \downarrow \\ * & \xrightarrow{\quad} & * \end{array} \right)$$

For the case of the crossed module $(U(1) \rightarrow 1)$ this recovers the cocycles for circle 2-bundles from observation 1.2.71.

Apart from the notion of *bundle gerbe*, there is also the original notion of *gerbe*. The terminology is somewhat unfortunate, since neither of these concepts is, in general, a special case of the other. But they are of course closely related. We consider here the simple cocycle-characterization of gerbes and the relation of these to cocycles for 2-bundles.

Definition 1.2.84 (G -gerbe). Let G be a smooth group. Then a cocycle for a smooth G -gerbe over a manifold X is a cocycle for a $\text{AUT}(G)$ -principal 2-bundle, where $\text{AUT}(G)$ is the automorphism 2-group from example 1.2.80.

Observation 1.2.85. For every 2-group coming from a crossed module $(G_1 \xrightarrow{\delta} G_0, \rho)$ there is a canonical morphism of 2-groups

$$(G_1 \rightarrow G_0) \rightarrow \text{AUT}(G_1)$$

given by the commuting diagram of groups

$$\begin{array}{ccc} G_1 & \xrightarrow{\delta} & G_0 \\ \downarrow \text{id} & & \downarrow \rho \\ G_1 & \xrightarrow{\text{Ad}} & \text{Aut}(G_0) \end{array} .$$

Accordingly, every $(G_1 \rightarrow G_0)$ -principal 2-bundle has an underlying G_1 -gerbe, def. 1.2.84. But in general the passage to this underlying G_1 -gerbe discards information.

Example 1.2.86. For G a simply connected and compact simple Lie group, let $\text{String} \simeq (\hat{\Omega}G \rightarrow PG)$ be the corresponding String 2-group from example 1.2.82. Then by observation 1.2.85 every String-principal 2-bundle has an underlying $\hat{\Omega}G$ -gerbe. But there is more information in the String-2-bundle than in this gerbe underlying it.

Example 1.2.87. Let $G = (\mathbb{Z} \hookrightarrow \mathbb{R})$ be the crossed module that includes the additive group of integers into the additive group of real numbers, with trivial action. The canonical projection morphism

$$\mathbf{B}(\mathbb{Z} \rightarrow \mathbb{R}) \xrightarrow{\simeq} \mathbf{B}U(1)$$

is a weak equivalence, by the fact that locally every smooth $U(1)$ -valued function is the quotient of a smooth \mathbb{R} -valued function by a (constant) \mathbb{Z} -valued function. This means in particular that up to equivalence, $(\mathbb{Z} \rightarrow \mathbb{R})$ -2-bundles are the same as ordinary circle 1-bundles. But it means a bit more than that:

On a manifold X also $\mathbf{B}\mathbb{Z}$ -principal 2-bundles have the same classification as $U(1)$ -bundles. But the *morphisms* of $\mathbf{B}\mathbb{Z}$ -principal 2-bundles are essentially different from those of $U(1)$ -bundles. This means that the 2-groupoid $\mathbf{B}\mathbb{Z}\text{Bund}(X)$ is not, in general equivalent to $U(1)\text{Bund}(X)$. But we do have an equivalence of 2-groupoids

$$(\mathbb{Z} \rightarrow U(1))\text{Bund}(X) \simeq U(1)\text{Bund}(X) .$$

Example 1.2.88. Let $\hat{G} \rightarrow G$ be a central extension of Lie groups by an abelian group A . This induces the crossed module $(A \rightarrow \hat{G})$. There is a canonical 2-anafunctor

$$\begin{array}{ccc} \mathbf{B}(A \rightarrow \hat{G}) & \xrightarrow{c} & \mathbf{B}(A \rightarrow 1) = \mathbf{B}^2 A \\ \downarrow \simeq & & \\ \mathbf{B}G & & \end{array}$$

from $\mathbf{B}G$ to $\mathbf{B}^2 A$. This can be seen to be the *characteristic class* that classifies the extension (see 1.2.7 below): $\mathbf{B}\hat{G} \rightarrow \mathbf{B}G$ is the A -principal 2-bundle classified by this cocycle.

Accordingly, the collection of all $(A \rightarrow \hat{G})$ -principal 2-bundles is, up to equivalence, the same as that of plain G -1-bundles. But they exhibit the natural projection to $\mathbf{B}A$ -2-bundles. Fixing that projection gives *twisted G -1-bundles*.

more in detail: the above 2-anafunctor induces a 2-anafunctor on cocycle 2-groupoid

$$\begin{array}{ccc} (A \rightarrow \hat{G})\text{Bund}(X) & \xrightarrow{c} & \mathbf{B}A\text{Bund}(X) \\ \downarrow \simeq & & \\ G\text{Bund}(X) & & \end{array}$$

If we fix a $\mathbf{B}A$ -2-bundle g we can consider the fiber of the characteristic class c over g , hence the pullback $G\text{Bund}_{[g]}(X)$ in

$$\begin{array}{ccc} G\text{Bund}_{[g]}(X) & \longrightarrow & * \\ \downarrow & & \downarrow g \\ (A \rightarrow \hat{G})\text{Bund}(X) & \xrightarrow{c} & \mathbf{B}A\text{Bund}(X) \\ \downarrow \simeq & & \\ G\text{Bund}(X) & & \end{array}$$

This is the groupoid of $[g]$ -twisted G -bundles. The principal 2-bundle classified by g is also called the *lifting gerbe* of the G -principal bundles underlying the $[g]$ -twisted \hat{G} -bundle: because this is the obstruction to lifting the former to a genuine \hat{G} -principal bundle.

If g is given by a Čech cocycle $\{g_{ijk} \in C^\infty(U_{ijk}, A)\}$ then $[g]$ -twisted G -bundles are given by data $\{h_{ij} \in C^\infty(U_{ij}, G)\}$ which does not quite satisfy the usual cocycle condition, but instead a modification by g :

$$h_{ik} = \delta(g_{ijk})h_{jk}h_{ij}.$$

For instance for the extension $U(1) \rightarrow U(n) \rightarrow PU(n)$ the corresponding twisted bundles are those that model *twisted K -theory* with n -torsion twists (4.4.8).

1.2.5.3 Principal 3-bundles and twisted 2-bundles As one passes beyond (smooth) 2-groups and their 2-principal bundles, one needs more sophisticated tools for presenting them. While the crossed modules from def. 1.2.74 have convenient higher analogs – called *crossed complexes* – the higher analog of remark 1.2.78 does not hold for these: not every (smooth) 3-group is presented by them, much less every n -group for $n > 3$. Therefore below in 1.2.5.4 we switch to a different tool for the general situation: simplicial groups.

However, it so happens that a wide range of relevant examples of (smooth) 3-groups and generally of smooth n -groups does have a presentation by a crossed complex after all, as do the examples which we shall discuss now.

Definition 1.2.89. A *crossed complex of groupoids* is a diagram

$$C_{\bullet} = \left(\begin{array}{ccccccc} \cdots & \xrightarrow{\delta} & C_3 & \xrightarrow{\delta} & C_2 & \xrightarrow{\delta} & C_1 \xrightarrow[\delta_s]{\delta_t} C_0 \\ & & \downarrow & & \downarrow & & \downarrow \delta_s \\ \cdots & \xrightarrow{=} & C_0 & \xrightarrow{=} & C_0 & \xrightarrow{=} & C_0 \xrightarrow{=} C_0 \end{array} \right),$$

where $C_1 \xrightarrow[\delta_s]{\delta_t} C_0$ is equipped with the structure of a 1-groupoid, and where $C_k \longrightarrow C_0$, for all $k \geq 2$, are bundles of groups, abelian for $k \geq 2$; and equipped with an action ρ of the groupoid C_1 , such that

1. the maps δ_k , $k \geq 2$ are morphisms of groupoids over C_0 compatible with the action by C_1 ;
2. $\delta_{k-1} \circ \delta_k = 0$; $k \geq 3$;
3. $\text{im}(\delta_2) \subset C_1$ acts by conjugation on C_2 and trivially on C_k , $k \geq 3$.

Surveys of standard material on crossed complexes of groupoids are in [BrHiSi11][Por]. We discuss sheaves of crossed complexes, hence *cohesive crossed complexes* in more detail below in 2.2.6. As mentioned there, the key aspect of crossed complexes is that they provide an equivalent encoding of precisely those ∞ -groupoids that are called *strict*.

Definition 1.2.90. A *crossed complex of groups* is a crossed complex C_{\bullet} of groupoids with $C_0 = *$. If the complex of groups is constant on the trivial group beyond C_n , we say this is a *strict n -group*.

Explicitly, a *crossed complex of groups* is a complex of groups of the form

$$\cdots \xrightarrow{\delta_2} G_2 \xrightarrow{\delta_1} G_1 \xrightarrow{\delta_0} G_0$$

with $G_{k \geq 2}$ abelian (but G_1 and G_0 not necessarily abelian), together with an action ρ_k of G_0 on G_k for all $k \in \mathbb{N}$, such that

1. ρ_0 is the adjoint action of G_0 on itself;
2. $\rho_1 \circ \delta_0$ is the adjoint action of G_1 on itself;
3. $\rho_k \circ \delta_0$ is the trivial action of G_1 on G_k for $k > 1$;
4. all δ_k respect the actions.

A morphism of crossed complexes of groups is a sequence of morphisms of component groups, respecting all this structure.

For $n = 2$ this reproduces the notion of *crossed module* and *strict 2-group*, def. 1.2.74. If furthermore G_1 and G_0 here are abelian and the action of G_0 is trivial, then this is an ordinary *complex of abelian groups* as considered in homological algebra. Indeed, all of homological algebra may be thought of as the study of this presentation of abelian ∞ -groups. (More on this in 2.2.6 below.)

We consider now examples of strict 3-groups and of the corresponding principal 3-bundles.

Example 1.2.91. For A an abelian group, the delooping of the 3-group given by the complex $(A \rightarrow 1 \rightarrow 1)$ is the one-object 3-groupoid that looks like

$$\mathbf{B}^3 A = \left(\begin{array}{ccc} * & \xrightarrow{\text{id}} & * \\ \uparrow \text{id} & \searrow \text{id} & \uparrow \text{id} \\ * & \xrightarrow{\text{id}} & * \end{array} \xrightarrow{a \in A} \begin{array}{ccc} * & \xrightarrow{\text{id}} & * \\ \uparrow \text{id} & \searrow \text{id} & \uparrow \text{id} \\ * & \xrightarrow{\text{id}} & * \end{array} \right)$$

Therefore an ∞ -anafunctor $X \xrightarrow{\cong} C(\{U_i\}) \xrightarrow{g} \mathbf{B}^3U(1)$ sends 3-simplices in the Čech groupoid

$$\left\{ \begin{array}{ccc} (x, j) & \longrightarrow & (x, k) \\ \uparrow & \Downarrow & \nearrow \\ (x, i) & \longrightarrow & (x, l) \end{array} \right\} \longrightarrow \left\{ \begin{array}{ccc} (x, j) & \longrightarrow & (x, k) \\ \uparrow & \Downarrow & \searrow \\ (x, i) & \longrightarrow & (x, l) \end{array} \right\}$$

to 3-morphisms in $\mathbf{B}^3U(1)$ labeled by group elements $g_{ijkl}(x) \in U(1)$

$$\left\{ \begin{array}{ccc} \bullet & \longrightarrow & \bullet \\ \uparrow & \Downarrow & \nearrow \\ \bullet & \longrightarrow & \bullet \end{array} \right\} \xrightarrow{g_{ijkl}(x)} \left\{ \begin{array}{ccc} \bullet & \longrightarrow & \bullet \\ \uparrow & \Downarrow & \searrow \\ \bullet & \longrightarrow & \bullet \end{array} \right\}$$

(where all 1-morphisms and 2-morphisms in $\mathbf{B}^3U(1)$ are necessarily identities).

The 3-functoriality of this assignment is given by the following identity on all Čech 4-simplices $(x, (h, i, j, k, l))$:

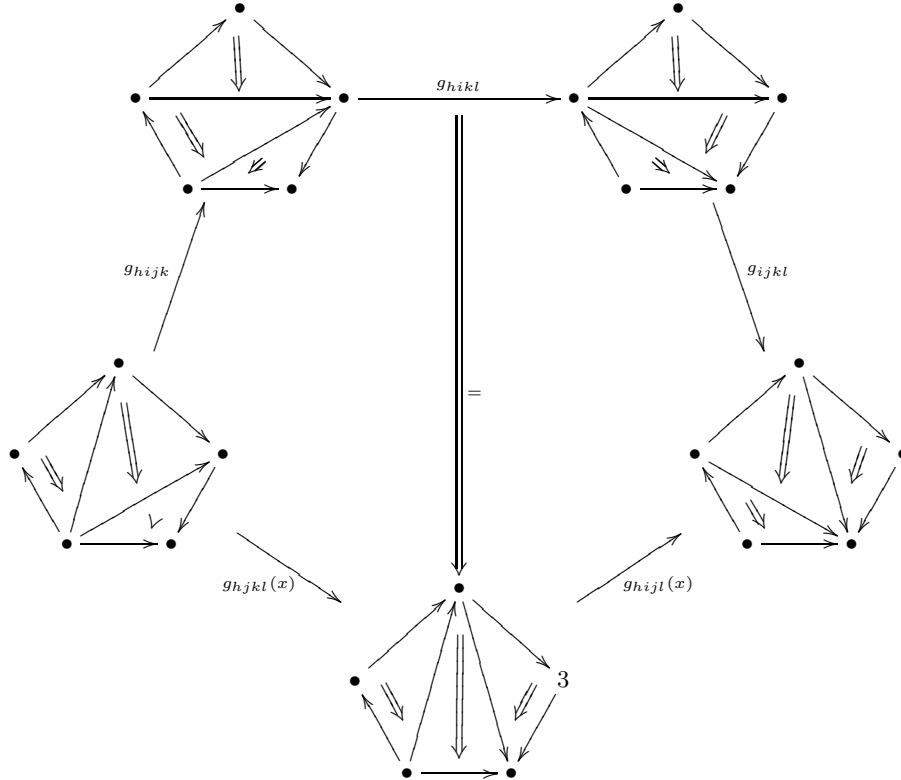

This means that the cocycle data $\{g_{ijkl}(x)\}$ has to satisfy the equations

$$g_{hijk}(x)g_{hikl}(x)g_{ijkl}(x) = g_{h_jkl}(x)g_{h_ijl}(x)$$

for all (h, i, j, k, l) and all $x \in U_{hijkl}$. Since $U(1)$ is abelian this can equivalently be rearranged to

$$g_{hijk}(x)g_{h_ijl}(x)^{-1}g_{hikl}(x)g_{h_jkl}(x)^{-1}g_{ijkl}(x) = 1.$$

This is the usual form in which a Čech 3-cocycles with coefficients in $U(1)$ are written.

Definition 1.2.92. Given a cocycle as above, the total space object \tilde{P} given by the pullback

$$\begin{array}{ccc} \tilde{P} & \longrightarrow & \mathbf{EB}^2U(1) \\ \downarrow & & \downarrow \\ C(U) & \xrightarrow{g} & \mathbf{B}^3U(1) \\ \downarrow \simeq & & \\ X & & \end{array}$$

is the corresponding *circle principal 3-bundle*.

In direct analogy to the argument that leads to observation 1.2.73 we find:

Observation 1.2.93. The structures known as *bundle 2-gerbes* [St01] are presentations of the 2-groupoids that are total spaces of circle principal 2-bundles, as above.

Again, notice that, despite a close relation, this is different from the original notion of *2-gerbe*. More discussion of this point is below in 4.3.10.

The next example is still abelian, but captures basics of the central mechanism of twistings of principal 2-bundles by principal 3-bundles.

Example 1.2.94. Consider a morphism $\delta : N \rightarrow A$ of abelian groups and the corresponding shifted crossed complex $(N \rightarrow A \rightarrow 1)$. The corresponding delooped 3-group looks like

$$\mathbf{B}(N \rightarrow A \rightarrow 1) = \left\{ \begin{array}{ccc} \begin{array}{ccc} \bullet & \xrightarrow{a_1} & \bullet \\ \uparrow & \searrow & \uparrow \\ \bullet & & \bullet \\ \downarrow & \swarrow & \downarrow \\ \bullet & \xrightarrow{a_2} & \bullet \end{array} & \xrightarrow{\delta(n)=a_4 a_3 a_2^{-1} a_1^{-1}} & \begin{array}{ccc} \bullet & \xrightarrow{a_3} & \bullet \\ \uparrow & \searrow & \uparrow \\ \bullet & & \bullet \\ \downarrow & \swarrow & \downarrow \\ \bullet & \xrightarrow{a_4} & \bullet \end{array} \end{array} \right\}.$$

A cocycle for a $(N \rightarrow A \rightarrow 1)$ -principal 3-bundle is given by data

$$\{a_{ijk} \in C^\infty(U_{ijk}, A), n_{ijkl} \in C^\infty(U_{ijkl}, N)\}$$

such that

1. $a_{jkl} a_{ijk}^{-1} a_{ijl} a_{ikl}^{-1} = \delta(n_{ijkl})$
2. $n_{hijk}(x) n_{hikl}(x) n_{ijkl}(x) = n_{hjkl}(x) n_{hijl}(x)$.

The first equation on the left is the cocycle for a 2-bundle as in observation 1.2.71. But the extra term n_{ijkl} on the right “twists” the cocycle. This twist itself satisfies a higher order cocycle condition.

Notice that there is a canonical projection

$$\mathbf{B}(N \rightarrow A \rightarrow 1) \rightarrow \mathbf{B}(N \rightarrow 1 \rightarrow 1) = \mathbf{B}^3N.$$

Therefore we can consider the higher analog of the notion of twisted bundles in example 1.2.88:

Definition 1.2.95. Let $N \rightarrow A$ be an inclusion and consider a fixed \mathbf{B}^2N -principal 3-bundle with cocycle g , let $\mathbf{B}(A/N)\text{Bund}_{[g]}(X)$ be the pullback in

$$\begin{array}{ccc} \mathbf{B}(A/N)\text{Bund}_{[g]}(X) & \longrightarrow & * \\ \downarrow & & \downarrow g \\ \mathbf{B}(N \rightarrow A)\text{Bund}(X) & \longrightarrow & \mathbf{B}^2N\text{Bund}(X) \\ \downarrow \simeq & & \\ \mathbf{B}(A/N)\text{Bund}(X) & & \end{array}$$

We say an object in this 2-groupoid is a $[g]$ -twisted $\mathbf{B}(A/N)$ -principal 2-bundle.

Below in example 1.2.136 we discuss this and its relation to characteristic classes of 2-bundles in more detail.

We now turn to the most general 3-group that is presented by a crossed complex.

Observation 1.2.96. For $(L \xrightarrow{\delta} H \xrightarrow{\delta} G)$ an arbitrary strict 3-group, def. 1.2.90, the delooping 3-groupoid looks like

$$\mathbf{B}(L \rightarrow H \rightarrow G) = \left\{ \begin{array}{c} \begin{array}{ccc} * & \xrightarrow{g_2} & * \\ \uparrow g_1 & \searrow h_1 & \nearrow \\ * & \xrightarrow{\delta(h_1)g_2g_1} & * \\ \downarrow & \searrow h_2 & \downarrow g_3 \\ * & \xrightarrow{\quad} & * \end{array} & \xrightarrow{\lambda \in L} & \begin{array}{ccc} * & \xrightarrow{g_2} & * \\ \uparrow g_1 & \searrow h_3 & \nearrow \\ * & \xrightarrow{\delta(h_3)g_2g_3} & * \\ \downarrow & \searrow h_4 & \downarrow g_3 \\ * & \xrightarrow{\quad} & * \end{array} \mid \begin{array}{l} h_4h_3 \\ = \\ \delta(\lambda) \cdot h_2 \cdot \rho(g_3)(h_1) \end{array} \end{array} \right\},$$

with the 4-cells – the composition identities – being

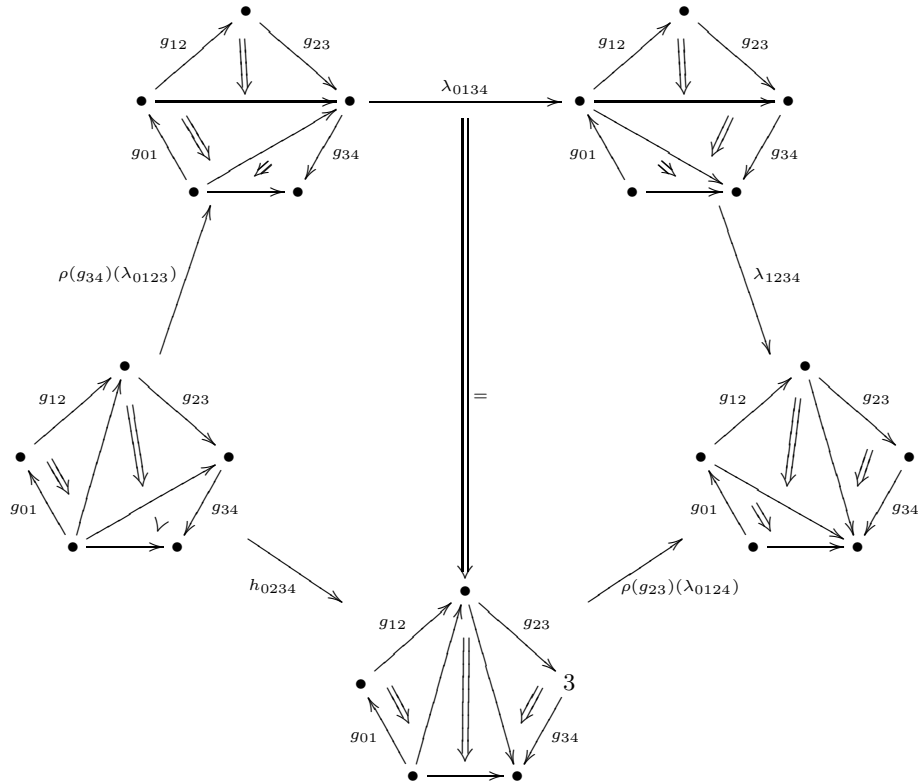

It follows that a cocycle

$$X \xrightarrow{\cong} C(U_i)^{(\lambda, h, g)} \mathbf{B}(L \rightarrow H \rightarrow G)$$

for a $(L \rightarrow H \rightarrow G)$ -principal 3-bundle is a collection of functions

$$\{g_{ij} \in C^\infty(U_{ij}, G), h_{ijk} \in C^\infty(U_{ijk}, H), \lambda_{ijkl} \in C^\infty(U_{ijkl}, L)\}$$

satisfying the cocycle conditions

$$\begin{aligned} g_{ik} &= \delta(h_{ijk})g_{jk}g_{ij} && \text{on } U_{ijk} \\ h_{ijl}h_{jkl} &= \delta(\lambda_{ijkl}) \cdot h_{ikl} \cdot \rho(g_3)(h_{ijk}) && \text{on } U_{ijkl} \\ \lambda_{ijkl}\lambda_{hikl}\rho(g_{kl})(\lambda_{hijk}) &= \rho(g_{jk})\lambda_{hijl}\lambda_{h_jkl} && \text{on } U_{hijkl}. \end{aligned}$$

Definition 1.2.97. Given such a cocycle, the pullback 3-groupoid P we call the corresponding *principal* $(L \rightarrow H \rightarrow G)$ -3-bundle

$$\begin{array}{ccc} P & \longrightarrow & \mathbf{EB}(L \rightarrow H \rightarrow G) \\ \downarrow & & \downarrow \\ C(U_i) & \xrightarrow{(\lambda, h, g)} & \mathbf{B}(L \rightarrow H \rightarrow G) \\ \downarrow \cong & & \\ X & & \end{array}$$

We can now give the next higher analog of the notion of twisted bundles, def. 1.2.88.

Definition 1.2.98. Given a 3-anafunctor

$$\begin{array}{ccc} \mathbf{B}(L \rightarrow H \rightarrow G) & \longrightarrow & \mathbf{B}(L \rightarrow 1 \rightarrow 1) = \mathbf{B}^3L \\ \downarrow \cong & & \\ \mathbf{B}(H/L \rightarrow G) & & \end{array}$$

then for g the cocycle for an \mathbf{B}^2L -principal 3-bundle we say that the pullback $(H \rightarrow G)\text{Bund}_g(X)$ in

$$\begin{array}{ccc} (H \rightarrow G)\text{Bund}_g(X) & \longrightarrow & * \\ \downarrow & & \downarrow g \\ (L \rightarrow H \rightarrow G)\text{Bund}(X) & \longrightarrow & \mathbf{B}^3L\text{Bund}(X) \end{array}$$

is the 3-groupoid of g -twisted $(H \rightarrow G)$ -principal 2-bundles on X .

Example 1.2.99. Let G be a compact and simply connected simple Lie group. By example 1.2.82 we have associated with this the *string 2-group* crossed module $\hat{\Omega}G \rightarrow PG$, where

$$U(1) \rightarrow \hat{\Omega}G \rightarrow \Omega G$$

is the Kac-Moody central extension of level 1 of the based loop group of G . Accordingly, there is an evident crossed complex

$$U(1) \rightarrow \hat{\Omega}G \rightarrow PG.$$

The evident projection

$$\mathbf{B}(U(1) \rightarrow \hat{\Omega}G \rightarrow PG) \xrightarrow{\cong} \mathbf{B}G$$

is a weak equivalence. This means that $(U(1) \rightarrow \hat{\Omega}G \rightarrow PG)$ -principal 3-bundles are equivalent to G -1-bundles. For fixed projection g to a $\mathbf{B}^2U(1)$ -3-bundle a $(U(1) \rightarrow \hat{\Omega}G \rightarrow PG)$ -principal 3-bundles may hence be thought of as a g -twisted string-principal 2-bundle.

One finds that these serve as a resolution of G -1-bundles in attempts to lift to string-2-bundles (discussed below in 5.1).

1.2.5.4 A model for principal ∞ -bundles We have seen above that the theory of ordinary smooth principal bundles is naturally situated within the context of Lie groupoids, and then that the theory of smooth principal 2-bundles is naturally situated within the theory of Lie 2-groupoids. This is clearly the beginning of a pattern in higher category theory where in the next step we see smooth 3-groupoids and so on. Finally the general theory of principal ∞ -bundles deals with smooth ∞ -groupoids. A comprehensive discussion of such smooth ∞ -groupoids is given in section 4.4. In this introduction here we will just briefly describe principal ∞ -bundles in this model.

Recall the discussion of ∞ -groupoids from 1.2.4.2.1, in terms of Kan simplicial sets. Consider an object $\mathbf{BG} \in [C^{\text{op}}, \text{sSet}]$ which is an ∞ -groupoid with a single object, so that we may think of it as the delooping of an ∞ -group G . Let $*$ be the point and $* \rightarrow \mathbf{BG}$ the unique inclusion map. The *good replacement* of this inclusion morphism is the *universal G -principal ∞ -bundle* $\mathbf{EG} \rightarrow \mathbf{BG}$ given by the pullback diagram

$$\begin{array}{ccc} \mathbf{EG} & \longrightarrow & * \\ \downarrow & & \downarrow \\ (\mathbf{BG})^{\Delta[1]} & \longrightarrow & \mathbf{BG} \\ \downarrow & & \\ \mathbf{BG} & & \end{array} .$$

An ∞ -anafunctor $X \xleftarrow{\simeq} \hat{X} \rightarrow \mathbf{BG}$ we call a *cocycle* on X with coefficients in G , and the ∞ -pullback P of the point along this cocycle, which by the above discussion is the ordinary limit

$$\begin{array}{ccccc} P & \longrightarrow & \mathbf{EG} & \longrightarrow & * \\ \downarrow & & \downarrow & & \downarrow \\ & & \mathbf{BG}^{\Delta[1]} & \longrightarrow & \mathbf{BG} \\ \downarrow & & \downarrow & & \\ \hat{X} & \xrightarrow{g} & \mathbf{BG} & & \\ \downarrow \simeq & & & & \\ X & & & & \end{array}$$

we call the principal ∞ -bundle $P \rightarrow X$ *classified* by the cocycle.

Example 1.2.100. A detailed description of the 3-groupoid fibration that constitutes the universal principal 2-bundle \mathbf{EG} for G any strict 2-group is given in [RoSc08].

It is now evident that our discussion of ordinary smooth principal bundles above is the special case of this for \mathbf{BG} the nerve of the one-object groupoid associated with the ordinary Lie group G . So we find the complete generalization of the situation that we already indicated there, which is summarized in the

following diagram:

$$\begin{array}{ccc}
 \vdots & & \vdots \\
 \vdots & & \vdots \\
 \tilde{P} \times G & \longrightarrow & \mathbf{E}G \times G \\
 \downarrow & & \downarrow \\
 \tilde{P} & \longrightarrow & \mathbf{E}G \\
 \downarrow & & \downarrow \\
 C(U) & \xrightarrow{g} & \mathbf{B}G \\
 \downarrow \simeq & & \\
 X & & \\
 \text{in the model category} & & \text{in the } \infty\text{-topos}
 \end{array}
 \qquad
 \begin{array}{ccc}
 P \times G & \longrightarrow & G \\
 \downarrow & \nearrow \simeq & \downarrow \\
 P & \longrightarrow & * \\
 \downarrow & \nearrow \simeq & \downarrow \\
 X & \xrightarrow{g} & \mathbf{B}G
 \end{array}$$

1.2.5.5 Higher fiber bundles We indicate here the natural notion of *principal bundle* in an ∞ -topos and how it relates to the intrinsic notion of cohomology discussed above.

1.2.5.5.1 Ordinary principal bundles For G a group, a G -*principal bundle* over some space X is, roughly, a space $P \rightarrow X$ over X , which is equipped with a G -action over X that is fiberwise free and transitive (“principal”), hence which after a choice of basepoint in a fiber looks there like the canonical action of G on itself. A central reason why the notion of G -principal bundles is relevant is that it constitutes a “geometric incarnation” of the degree-1 (nonabelian) cohomology $H^1(X, G)$ of X with coefficients in G (with G regarded as the sheaf of G -valued functions on G): G -principal bundles are *classified* by $H^1(X, G)$. We will see that this classical statement is a special case of a natural and much more general fact, where *principal ∞ -bundles* incarnate cocycles in the intrinsic cohomology of any ∞ -topos. Before coming to that, here we briefly review aspects of the classical theory to set the scene.

Let G be a topological group and let X be a topological space.

Definition 1.2.101. A *topological G -principal bundle* over X is a continuous map $p : P \rightarrow X$ equipped with a continuous fiberwise G -action $\rho : P \times G \rightarrow G$

$$\begin{array}{c}
 P \times G \\
 p_1 \downarrow \downarrow \rho \\
 P \\
 \downarrow p \\
 X
 \end{array}$$

which is *locally trivial*: there exists a cover $\phi : U \rightarrow X$ and an isomorphism of topological G -spaces

$$P|_U \simeq U \times G$$

between the restriction (pullback) of P to U and the trivial bundle $U \times G \rightarrow U$ equipped with the canonical G -action given by multiplication in G .

Observation 1.2.102. Let $P \rightarrow X$ be a topological G -principal bundle. An immediate consequence of the definition is

1. The base space X is isomorphic to the quotient of P by the G -action, and, moreover, under this identification $P \rightarrow X$ is the quotient projection $P \rightarrow P/G$.

2. The *principality condition* is satisfied: the *shear map*

$$(p_1, \rho) : P \times G \rightarrow P \times_X P$$

is an isomorphism.

Remark 1.2.103. Sometimes the quotient property of principal bundles has been taken to be the defining property. For instance [Cart50a, Cart50b] calls every quotient map $P \rightarrow P/G$ of a free topological group action a “ G -principal bundle”, *without* requiring it to be locally trivial. This is a strictly weaker definition: there are many examples of such quotient maps which are not locally trivial. To distinguish the notions, [Pa61] refers to the weaker definition as that of a *Cartan principal bundle*. Also for instance the standard textbook [Hus94] takes the definition via quotient maps as fundamental and explicitly adds the adjective “locally trivial” when necessary.

For our purposes the following two points are relevant.

1. Local triviality is crucial for the classification of topological G -principal bundles by nonabelian sheaf cohomology to work, and so from this perspective a *Cartan principal bundle* may be pathological.
2. On the other hand, we see below that this problem is an artefact of considering G -principal bundles in the ill-suited context of the 1-category of topological spaces or manifolds. We find below that after embedding into an ∞ -topos (for instance that of Euclidean topological ∞ -groupoids, discussed in 4.3) both definitions in fact coincide.

The reason is that the Yoneda embedding into the higher categorical context of an ∞ -topos “corrects the quotients”: those quotients of G -actions that are not locally trivial get replaced, while the “good quotients” are being preserved by the embedding. This statement we make precise in 3.6.10.4 below. See also the discussion in 3.6.10.1 below.

It is a classical fact that for X a manifold and G a topological or Lie group, regarded as a sheaf of groups $C(-, G)$ on X , there is an equivalence of the following kind

algebraic data on X	\simeq	geometric data on X
$\left\{ \begin{array}{l} \text{degree-1 nonabelian} \\ \text{sheaf cohomology} \\ H^1(X, G) \end{array} \right\}$	\simeq	$\left\{ \begin{array}{l} \text{isomorphism classes of} \\ \text{G-principal bundles over } X \\ \text{GBund}(X) \end{array} \right\}$
$\left(\begin{array}{ccc} & (x, j) & \\ & \uparrow \quad \downarrow & \\ (x, i) & \xrightarrow{g} & (x, k) & \xrightarrow{g_{ij}(x)} & * & \xrightarrow{g_{jk}(x)} & * \\ & \downarrow & & \downarrow & & \downarrow & \\ & x & & * & \xrightarrow{g_{ik}(x)} & * & \end{array} \right) \Big/ \sim$ $X \xrightarrow{g} \mathbf{B}G$ <p style="text-align: center;">cocycle</p>	\simeq	$\left(\begin{array}{ccc} P \times G & \xrightarrow{\quad} & EG \times G \\ \downarrow p_1 & \rho & \downarrow p_1 & \rho & G\text{-actions} \\ P & \xrightarrow{\quad} & EG & \text{total spaces} \\ \downarrow & \text{pullback} & \downarrow & \\ X & \xrightarrow{ g } & BG & \text{quotient spaces} \\ G\text{-principal bundle} & \text{classifying map} & \text{universal bundle} \end{array} \right) \Big/ \sim$

We give a detailed exposition of the construction indicated in this diagram below in 1.2.5.1.

1.2.5.5.2 Principal ∞ -bundles Let now \mathbf{H} be an ∞ -topos, 1.2.4.2, and G a group object in \mathbf{H} , 1.2.4.2.3. Up to the technical issue of formulating homotopy coherence, the formulation in \mathbf{H} of the definition of G -principal bundles, 1.2.5.5.1, in its version as *Cartan G -principal bundle*, remark 1.2.103, is immediate: **Definition.** A G -principal bundle over $X \in \mathbf{H}$ is

- a morphism $P \rightarrow X$; with an ∞ -action $\rho : P \times G \rightarrow P$;

- such that $P \rightarrow X$ is the ∞ -quotient map $P \rightarrow P//G$.

In 3.6.10 below we discuss a precise formulation of this definition and the details of the following central statement about the relation between G -principal ∞ -bundles and the intrinsic cohomology of \mathbf{H} with coefficients in the delooping object $\mathbf{B}G$.

Theorem. There is equivalence of ∞ -groupoids $GBund(X) \xrightleftharpoons[\lim_{\rightarrow}]{\text{hofib}} \mathbf{H}(X, \mathbf{B}G)$, where

1. hofib sends a cocycle $X \rightarrow \mathbf{B}G$ to its homotopy fiber;
2. \lim_{\rightarrow} sends an ∞ -bundle to the map on ∞ -quotients $X \simeq P//G \rightarrow *//G \simeq \mathbf{B}G$.

In particular, G -principal ∞ -bundles are classified by the intrinsic cohomology of \mathbf{H}

$$GBund(X)/\sim \simeq H^1(X, G) := \pi_0 \mathbf{H}(X, \mathbf{B}G).$$

Idea of Proof. Repeatedly apply two of the *Giraud-Rezk-Lurie axioms*, def. 2.2.2, that characterize ∞ -toposes:

1. every ∞ -quotient is effective;
2. ∞ -colimits are preserved by ∞ -pullbacks.

□

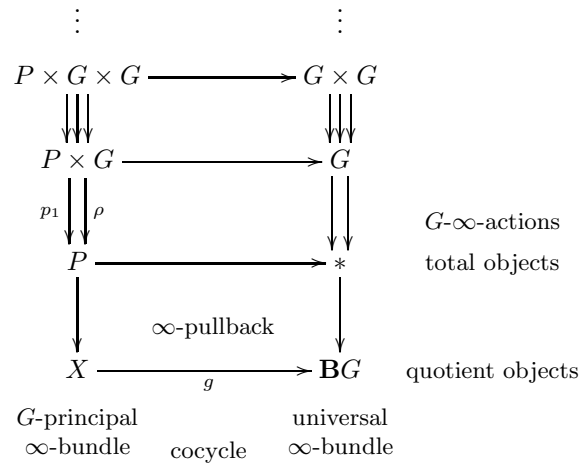

This gives a general abstract theory of principal ∞ -bundles in every ∞ -topos. We also have the following explicit presentation. **Definition** For $G \in \text{Grp}(\text{sSh}(C))$, and $X \in \text{sSh}(C)_{\text{fib}}$, a *weakly G -principal simplicial bundle* is a G -action ρ over X such that the *principality morphism* $(\rho, p_1) : P \times G \rightarrow P \times_X P$ is a stalkwise weak equivalence.

Below in 3.6.10.4 we discuss that this construction gives a presentation of the ∞ -groupoid of G -principal bundles as the nerve of the ordinary category of weakly G -principal simplicial bundles.

$$\text{Nerve} \left\{ \begin{array}{l} \text{weakly } G\text{-principal} \\ \text{simplicial bundles} \\ \text{over } X \end{array} \right\} \simeq GBund(X).$$

For the special case that X is the terminal object over the site C and when restricted from cocycle ∞ -groupoids to sets of cohomology classes, this reproduces the statement of [JaLu04]. For our applications in 5, in particular for applications in twisted cohomology, 3.6.12, it is important to have the general statement, where the base space of a principal ∞ -bundle may be an arbitrary ∞ -stack, and where we remember the ∞ -groupoids of gauge transformations between them, instead of passing to their sets of equivalence classes.

The special case where the site C is trivial, $C = *$, leads to the notion of principal ∞ -bundles in ∞Grp . These are presented by certain bundles of simplicial sets. This we discuss below in 4.2.4.

1.2.5.5.3 Associated and twisted ∞ -bundles The notion of G -principal bundle is a very special case of the following natural more general notion. For any F , an *F -fiber bundle* over some X is a space $E \rightarrow X$ over X such that there is a cover $U \rightarrow X$ over which it becomes equivalent as a bundle to the trivial F -bundle $U \times F \rightarrow U$.

Principal bundles themselves form but a small subclass of all possible fiber bundles over some space X . Even among G -fiber bundles the G -principal bundles are special, due to the constraint that the local trivialization has to respect the G -action on the fibers. However, every F -fiber bundle is *associated* to a G -principal bundle.

Given a representation $\rho : F \times G \rightarrow F$, the ρ -associated F -fiber bundle is the quotient $P \times_G F$ of the product $P \times F$ by the diagonal G -action. Conversely, using that the automorphism group $\text{Aut}(F)$ of F canonically acts on F , it is immediate that every F -fiber bundle is associated to an $\text{Aut}(F)$ -principal bundle (a statement which, of course, crucially uses the local triviality clause).

All of these constructions and statements have their straightforward generalizations to higher bundles, hence to *associated ∞ -bundles*. Moreover, just as the theory of principal bundles *improves* in the context of ∞ -toposes, as discussed above, so does the theory of associated bundles.

For notice that by the above classification theorem of G -principal ∞ -bundles, every G - ∞ -action $\rho : V \times G \rightarrow G$ has a *classifying map*, which we will denote by the same symbol:

$$\begin{array}{ccc} V & \longrightarrow & V//G \\ & & \downarrow \rho \\ & & \mathbf{B}G \end{array} .$$

One may observe now that this map $V//G \rightarrow \mathbf{B}G$ is the *universal ρ -associated V - ∞ -bundle*: for every F -fiber ∞ -bundle $E \rightarrow X$ there is a morphism $X \rightarrow \mathbf{B}G$ such that $E \rightarrow X$ is the ∞ -pullback of this map to X .

$$\begin{array}{ccc} E & \longrightarrow & V//G \\ \downarrow & & \downarrow \rho \\ X & \xrightarrow{g} & \mathbf{B}G \end{array} .$$

One implication of this is, by the universal property of the ∞ -pullback, that *sections σ* of the associated bundle

$$\begin{array}{c} E \\ \sigma \curvearrowright \downarrow \\ X \end{array}$$

are equivalently lifts of its classifying map through the universal ρ -associated bundle

$$\Gamma_X(P \times_G V) := \left\{ \begin{array}{ccc} & & V//G \\ & \nearrow \sigma & \downarrow \rho \\ X & \xrightarrow{g} & \mathbf{B}G \end{array} \right\} .$$

One observes that by local triviality and by the fact that V is, by the above, the homotopy fiber of $V//G \rightarrow \mathbf{B}G$, it follows that locally over a cover $U \rightarrow X$ such a section is identified with a V -valued map $U \rightarrow V$. Conversely, globally a section of a ρ -associated bundle may be regarded as a *twisted V -valued function*.

While this is an elementary and familiar statement for ordinary associated bundles, this is where the theory of associated ∞ -bundles becomes considerably richer than that of ordinary ∞ -bundles: because here V itself may be a higher stack, notably it may be a moduli ∞ -stack $V = \mathbf{B}A$ for A -principal ∞ -bundles. If so, maps $U \rightarrow V$ classify A -principal ∞ -bundles locally over the cover U of X , and so conversely the section σ itself may globally be regarded as exhibiting a *twisted A -principal ∞ -bundle* over X .

We can refine this statement by furthermore observing that the space of all sections as above is itself the hom-space in an ∞ -topos, namely in the slice ∞ -topos $\mathbf{H}/_{\mathbf{B}G}$. This means that such sections are themselves cocycles in a structured nonabelian cohomology theory:

$$\Gamma_X(P \times_G V) := \mathbf{G}/_{\mathbf{B}G}(g, \rho) .$$

This we may call the g -twisted cohomology of X relative to ρ . We discuss below in 5.2 how traditional notions of twisted cohomology are special cases of this general notion, as are many further examples.

Now ρ , regarded as an object of the slice $\mathbf{H}/_{\mathbf{B}G}$ is not in general a connected object. This means that it is not in general the moduli object for some principal ∞ -bundles over the slice. But instead, we find that we can naturally identify geometric incarnations of such cocycles in the form of *twisted ∞ -bundles*.

Theorem. The g -twisted cohomology $\mathbf{H}/_{\mathbf{B}G}(g, \rho)$ classifies P -twisted ∞ -bundles: twisted G -equivariant ΩV - ∞ -bundles on P :

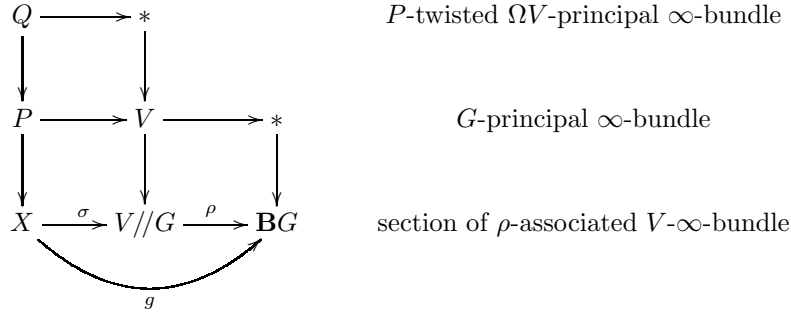

$$\left\{ \begin{array}{c} \text{sections of} \\ \rho\text{-associated } V\text{-}\infty\text{-bundle} \end{array} \right\} \simeq \left\{ \begin{array}{c} g\text{-twisted } \Omega V\text{-cohomology} \\ \text{relative } \rho \end{array} \right\} \simeq \left\{ \begin{array}{c} \Omega V\text{-}\infty\text{-bundles} \\ \text{twisted by } P \end{array} \right\}$$

A survey of classes of examples of twisted ∞ -bundles classified by twisted cohomology is below in 5.2.1. Among them, in particular the classical notion of nonabelian *gerbe* [Gir71], and *2-gerbe* [Br94] is a special case.

Namely one see that a (nonabelian/Giraud-)gerbe on X is nothing but a connected and 1-truncated object in $\mathbf{H}/_X$. Similarly, a (nonabelian/Breen) *2-gerbe* over X is just a connected and 2-truncated object in $\mathbf{H}/_X$. Accordingly we may call a general connecte object in $\mathbf{H}/_X$ an *nonabelian ∞ -gerbe* over X . We say that it is a G - ∞ -gerbe if it is an $\text{Aut}(\mathbf{B}G)$ -associated ∞ -bundle. We say its *band* is the underlying $\text{Out}(G)$ -principal ∞ -bundle. For 1-gerbes and 2-gerbes this reproduces the classical notions.

In terms of this, the above says that G - ∞ -gerbes *bound by a band* are classified by $(\mathbf{B}\text{Aut}(\mathbf{B}G) \rightarrow \mathbf{B}\text{Out}(G))$ -twisted cohomology. This is the generalization of Giraud's original theorem. We discuss all this in detail below in 3.6.15.

1.2.6 Principal connections

1.2.6.1 Parallel n -transport for low n With a decent handle on principal ∞ -bundles as described above, we now turn to the description of *connections on ∞ -bundles*. It will turn out that the above cocycle-description of G -principal ∞ -bundles in terms of ∞ -anafunctors $X \xrightarrow{\simeq} \hat{X} \xrightarrow{g} \mathbf{B}G$ has, under mild conditions, a natural generalization where $\mathbf{B}G$ is replaced by a (non-concrete) simplicial presheaf $\mathbf{B}G_{\text{conn}}$, which we may think of as the ∞ -groupoid of ∞ -Lie algebra valued forms. This comes with a canonical map $\mathbf{B}G_{\text{conn}} \rightarrow \mathbf{B}G$ and an ∞ -connection ∇ on the ∞ -bundle classified by g is a lift ∇ of g in the diagram

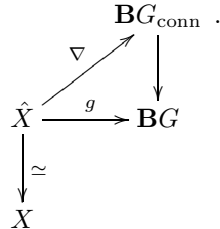

In the language of ∞ -stacks we may think of $\mathbf{B}G$ as the ∞ -stack (on CartSp) or ∞ -prestack (on SmoothMfd) $G\text{TrivBund}(-)$ of *trivial* G -principal bundles, and of $\mathbf{B}G_{\text{conn}}$ correspondingly as the object $G\text{TrivBund}_{\nabla}(-)$

of trivial G -principal bundles with (non-trivial) connection. In this sense the statement that ∞ -connections are cocycles with coefficients in some $\mathbf{BG}_{\text{conn}}$ is a tautology. The real questions are:

1. What is $\mathbf{BG}_{\text{conn}}$ in concrete formulas?
2. Why are these formulas what they are? What is the general abstract concept of an ∞ -connection? What are its defining abstract properties?

A comprehensive answer to the second question is provided by the general abstract concepts discussed in section 3. Here in this introduction we will not go into the full abstract theory, but using classical tools we get pretty close. What we describe is a generalization of the concept of *parallel transport* to *higher parallel transport*. As we shall see, this is naturally expressed in terms of ∞ -anafunctors out of path n -groupoids. This reflects how the full abstract theory arises in the context of an ∞ -connected ∞ -topos that comes canonically with a notion of fundamental ∞ -groupoid.

Below we begin the discussion of ∞ -connections by reviewing the classical theory of connections on a bundle in a way that will make its generalization to higher connections relatively straightforward. In an analogous way we can then describe certain classes of connections on a 2-bundle – subsuming the notion of connection on a bundle gerbe. With that in hand we then revisit the discussion of connections on ordinary bundles. By associating to each bundle with connection its corresponding *curvature 2-bundle with connection* we obtain a more refined description of connections on bundles, one that is naturally adapted to the construction of curvature characteristic forms in the Chern-Weil homomorphism. This turns out to be the kind of formulation of connections on an ∞ -bundle that drops out of the general abstract theory. In classical terms, its full formulation involves the description of circle n -bundles with connection in terms of Deligne cohomology and the description of the ∞ -groupoid of ∞ -Lie algebra valued forms in terms of dg-algebra homomorphisms. The combination of these two aspects yields naturally an explicit model for the Chern-Weil homomorphism and its generalization to higher bundles.

Taken together, these constructions allow us to express a good deal of the general ∞ -Chern-Weil theory with classical tools. As an example, we describe how the classical Čech-Deligne cocycle construction of the refined Chern-Weil homomorphism drops out from these constructions.

1.2.6.1.1 Connections on a principal bundle There are different equivalent definitions of the classical notion of a connection. One that is useful for our purposes is that a connection ∇ on a G -principal bundle $P \rightarrow X$ is a rule tra_{∇} for *parallel transport* along paths: a rule that assigns to each path $\gamma : [0, 1] \rightarrow X$ a morphism $\text{tra}_{\nabla}(\gamma) : P_x \rightarrow P_y$ between the fibers of the bundle above the endpoints of these paths, in a compatible way:

$$\begin{array}{ccc}
 P_x \xrightarrow{\text{tra}_{\nabla}(\gamma)} P_y \xrightarrow{\text{tra}_{\nabla}(\gamma')} P_z & & P \\
 & & \downarrow \\
 x \xrightarrow{\gamma} y \xrightarrow{\gamma'} z & & X
 \end{array}$$

In order to formalize this, we introduce a (diffeological) Lie groupoid to be called the *path groupoid* of X . (Constructions and results in this section are from [ScWa07].)

Definition 1.2.104. For X a smooth manifold let $[I, X]$ be the set of smooth functions $I = [0, 1] \rightarrow X$. For U a Cartesian space, we say that a *U -parameterized smooth family of points in $[I, X]$* is a smooth map $U \times I \rightarrow X$. (This makes $[I, X]$ a diffeological space).

Say a path $\gamma \in [I, X]$ has *sitting instants* if it is constant in a neighbourhood of the boundary ∂I . Let $[I, P]_{\text{si}} \subset [I, P]$ be the subset of paths with sitting instants.

Let $[I, X]_{\text{si}} \rightarrow [I, X]_{\text{si}}^{\text{th}}$ be the projection to the set of equivalence classes where two paths are regarded as equivalent if they are cobounded by a smooth thin homotopy.

Say a U -parameterized smooth family of points in $[I, X]_{\text{si}}^{\text{th}}$ is one that comes from a U -family of representatives in $[I, X]_{\text{si}}$ under this projection. (This makes also $[I, X]_{\text{si}}^{\text{th}}$ a diffeological space.)

The passage to the subset and quotient $[I, X]_{\text{si}}^{\text{th}}$ of the set of all smooth paths in the above definition is essentially the minimal adjustment to enforce that the concatenation of smooth paths at their endpoints defines the composition operation in a groupoid.

Definition 1.2.105. The *path groupoid* $\mathbf{P}_1(X)$ is the groupoid

$$\mathbf{P}_1(X) = ([I, X]_{\text{si}}^{\text{th}} \rightrightarrows X)$$

with source and target maps given by endpoint evaluation and composition given by concatenation of classes $[\gamma]$ of paths along any orientation preserving *diffeomorphism* $[0, 1] \rightarrow [0, 2] \simeq [0, 1] \coprod_{1,0} [0, 1]$ of any of their representatives

$$[\gamma_2] \circ [\gamma_1] : [0, 1] \xrightarrow{\simeq} [0, 1] \coprod_{1,0} [0, 1] \xrightarrow{(\gamma_2, \gamma_1)} X.$$

This becomes an internal groupoid in diffeological spaces with the above U -families of smooth paths. We regard it as a groupoid-valued presheaf, an object in $[\text{CartSp}^{\text{op}}, \text{Grpd}]$:

$$\mathbf{P}_1(X) : U \mapsto (\text{SmoothMfd}(U \times I, X)_{\text{si}}^{\text{th}} \rightrightarrows \text{SmoothMfd}(U, X)).$$

Observe now that for G a Lie group and \mathbf{BG} its delooping Lie groupoid discussed above, a smooth functor $\text{tra} : \mathbf{P}_1(X) \rightarrow \mathbf{BG}$ sends each (thin-homotopy class of a) path to an element of the group G

$$\text{tra} : (x \xrightarrow{[\gamma]} y) \mapsto (\bullet \xrightarrow{\text{tra}(\gamma) \in G} \bullet)$$

such that composite paths map to products of group elements :

$$\text{tra} : \left\{ \begin{array}{ccc} & y & \\ [\gamma] \nearrow & & \searrow [\gamma'] \\ x & \xrightarrow{[\gamma' \circ \gamma]} & z \end{array} \right\} \mapsto \left\{ \begin{array}{ccc} & * & \\ \text{tra}(\gamma) \nearrow & & \searrow \text{tra}(\gamma') \\ * & \xrightarrow{\text{tra}(\gamma') \text{tra}(\gamma)} & * \end{array} \right\}.$$

and such that U -families of smooth paths induce smooth maps $U \rightarrow G$ of elements.

There is a classical construction that yields such an assignment: the *parallel transport* of a *Lie-algebra valued 1-form*.

Definition 1.2.106. Suppose $A \in \Omega^1(X, \mathfrak{g})$ is a degree-1 differential form on X with values in the Lie algebra \mathfrak{g} of G . Then its parallel transport is the smooth functor

$$\text{tra}_A : \mathbf{P}_1(X) \rightarrow \mathbf{BG}$$

given by

$$[\gamma] \mapsto P \exp \left(\int_{[0,1]} \gamma^* A \right) \in G,$$

where the group element on the right is defined to be the value at 1 of the unique solution $f : [0, 1] \rightarrow G$ of the differential equation

$$d_{\text{dR}} f + \gamma^* A \wedge f = 0$$

for the boundary condition $f(0) = e$.

Proposition 1.2.107. This construction $A \mapsto \text{tra}_A$ induces an equivalence of categories

$$[\text{CartSp}^{\text{op}}, \text{Grpd}](\mathbf{P}_1(X), \mathbf{BG}) \simeq \mathbf{BG}_{\text{conn}}(X),$$

where on the left we have the hom-groupoid of groupoid-valued presheaves, and where on the right we have the groupoid of Lie-algebra valued 1-forms, whose

- objects are 1-forms $A \in \Omega^1(X, \mathfrak{g})$,
- morphisms $g : A_1 \rightarrow A_2$ are labeled by smooth functions $g \in C^\infty(X, G)$ such that $A_2 = g^{-1}A_1 + g^{-1}dg$.

This equivalence is natural in X , so that we obtain another smooth groupoid.

Definition 1.2.108. Define $\mathbf{BG}_{\text{conn}} : \text{CartSp}^{\text{op}} \rightarrow \text{Grpd}$ to be the (generalized) Lie groupoid

$$\mathbf{BG}_{\text{conn}} : U \mapsto [\text{CartSp}^{\text{op}}, \text{Grpd}](\mathbf{P}_1(-), \mathbf{BG})$$

whose U -parameterized smooth families of groupoids form the groupoid of Lie-algebra valued 1-forms on U .

This equivalence in particular subsumes the classical facts that parallel transport $\gamma \mapsto P \exp(\int_{[0,1]} \gamma^* A)$

- is invariant under orientation preserving reparameterizations of paths;
- sends reversed paths to inverses of group elements.

Observation 1.2.109. There is an evident natural smooth functor $X \rightarrow \mathbf{P}_1(X)$ that includes points in X as constant paths. This induces a natural morphism $\mathbf{BG}_{\text{conn}} \rightarrow \mathbf{BG}$ that forgets the 1-forms.

Definition 1.2.110. Let $P \rightarrow X$ be a G -principal bundle that corresponds to a cocycle $g : C(U) \rightarrow \mathbf{BG}$ under the construction discussed above. Then a *connection* ∇ on P is a lift ∇ of the cocycle through $\mathbf{BG}_{\text{conn}} \rightarrow \mathbf{BG}$.

$$\begin{array}{ccc} & & \mathbf{BG}_{\text{conn}} \\ & \nearrow \nabla & \downarrow \\ C(U) & \xrightarrow{g} & \mathbf{BG} \end{array}$$

Observation 1.2.111. This is equivalent to the traditional definitions.

A morphism $\nabla : C(U) \rightarrow \mathbf{BG}_{\text{conn}}$ is

- on each U_i a 1-form $A_i \in \Omega^1(U_i, \mathfrak{g})$;
- on each $U_i \cap U_j$ a function $g_{ij} \in C^\infty(U_i \cap U_j, G)$;

such that

- on each $U_i \cap U_j$ we have $A_j = g_{ij}^{-1}(A_i + d_{\text{dR}})g_{ij}$;
- on each $U_i \cap U_j \cap U_k$ we have $g_{ij} \cdot g_{jk} = g_{ik}$.

Definition 1.2.112. Let $[I, X]_{\text{si}}^{\text{th}} \rightarrow [I, X]^h$ the projection onto the full quotient by smooth homotopy classes of paths. Write $\mathbf{\Pi}_1(X) = ([I, X]^h \rightrightarrows X)$ for the smooth groupoid defined as $\mathbf{P}_1(X)$, but where instead of thin homotopies, all homotopies are divided out.

Proposition 1.2.113. *The above restricts to a natural equivalence*

$$[\text{CartSp}^{\text{op}}, \text{Grpd}](\mathbf{\Pi}_1(X), \mathbf{BG}) \simeq \mathfrak{b}\mathbf{BG},$$

where on the left we have the hom-groupoid of groupoid-valued presheaves, and on the right we have the full sub-groupoid $\mathfrak{b}\mathbf{BG} \subset \mathbf{BG}_{\text{conn}}$ on those \mathfrak{g} -valued differential forms whose curvature 2-form $F_A = d_{\text{dR}}A + [A \wedge A]$ vanishes.

A connection ∇ is flat precisely if it factors through the inclusion $\mathfrak{b}\mathbf{BG} \rightarrow \mathbf{BG}_{\text{conn}}$.

For the purposes of Chern-Weil theory we want a good way to extract the curvature 2-form in a general abstract way from a cocycle $\nabla : X \xrightarrow{\sim} C(U) \rightarrow \mathbf{BG}_{\text{conn}}$. In order to do that, we first need to discuss connections on 2-bundles.

1.2.6.1.2 Connections on a principal 2-bundle There is an evident higher dimensional generalization of the definition of connections on 1-bundles in terms of functors out of the path groupoid discussed above. This we discuss now. We will see that, however, the obvious generalization captures not quite all 2-connections. But we will also see a way to recode 1-connections in terms of flat 2-connections. And that recoding then is the right general abstract perspective on connections, which generalizes to principal ∞ -bundles and in fact which in the full theory follows from first principles.

(Constructions and results in this section are from [ScWa08], [ScWa08].)

Definition 1.2.114. The path *path 2-groupoid* $\mathbf{P}_2(X)$ is the smooth strict 2-groupoid analogous to $\mathbf{P}_1(X)$, but with nontrivial 2-morphisms given by thin homotopy-classes of disks $\Delta_{Diff}^2 \rightarrow X$ with sitting instants.

In analogy to the projection $\mathbf{P}_1(X) \rightarrow \mathbf{\Pi}_1(X)$ there is a projection to $\mathbf{P}_2(X) \rightarrow \mathbf{\Pi}_2(X)$ to the 2-groupoid obtained by dividing out full homotopy of disks, relative boundary.

We want to consider 2-functors out of the path 2-groupoid into connected 2-groupoids of the form \mathbf{BG} , for G a 2-group, def. 1.2.74. A smooth 2-functor $\mathbf{\Pi}_2(X) \rightarrow \mathbf{BG}$ now assigns information also to surfaces

$$\text{tra} : \left\{ \begin{array}{ccc} & y & \\ [\gamma] \nearrow & & \searrow [\gamma'] \\ x & \xrightarrow{[\gamma' \circ \gamma]} & z \\ & \Downarrow [\Sigma] & \\ & & \end{array} \right\} \mapsto \left\{ \begin{array}{ccc} & * & \\ \text{tra}(\gamma) \nearrow & & \searrow \text{tra}(\gamma') \\ * & \xrightarrow{\text{tra}(\downarrow[\Sigma])} & * \\ & \Downarrow & \end{array} \right\}$$

and thus encodes *higher parallel transport*.

Proposition 1.2.115. *There is a natural equivalence of 2-groupoids*

$$[\text{CartSp}^{\text{op}}, 2\text{Grpd}](\mathbf{\Pi}_2(X), \mathbf{BG}) \simeq \mathbf{bBG}$$

where on the right we have the 2-groupoid of Lie 2-algebra valued forms] whose

- objects are pairs $A \in \Omega^1(X, \mathfrak{g}_1)$, $B \in \Omega^2(X, \mathfrak{g}_2)$ such that the 2-form curvature

$$F_2(A, B) := d_{\text{dR}}A + [A \wedge A] + \delta_* B$$

and the 3-form curvature

$$F_3(A, B) := d_{\text{dR}}B + [A \wedge B]$$

vanish.

- morphisms $(\lambda, a) : (A, B) \rightarrow (A', B')$ are pairs $a \in \Omega^1(X, \mathfrak{g}_2)$, $\lambda \in C^\infty(X, G_1)$ such that $A' = \lambda A \lambda^{-1} + \lambda d\lambda^{-1} + \delta_* a$ and $B' = \lambda(B) + d_{\text{dR}}a + [A \wedge a]$
- The description of 2-morphisms we leave to the reader (see [ScWa08]).

As before, this is natural in X , so that we that we get a presheaf of 2-groupoids

$$\mathbf{bBG} : U \mapsto [\text{CartSp}^{\text{op}}, 2\text{Grpd}](\mathbf{\Pi}_2(U), \mathbf{BG}) .$$

Proposition 1.2.116. *If in the above definition we use $\mathbf{P}_2(X)$ instead of $\mathbf{\Pi}_2(X)$, we obtain the same 2-groupoid, except that the 3-form curvature $F_3(A, B)$ is not required to vanish.*

Definition 1.2.117. Let $P \rightarrow X$ be a G -principal 2-bundle classified by a cocycle $C(U) \rightarrow \mathbf{BG}$. Then a structure of a *flat connection on a 2-bundle* ∇ on it is a lift

$$\begin{array}{ccc} & \mathbf{bBG} & . \\ \nabla_{\text{flat}} \nearrow & & \downarrow \\ C(U) & \xrightarrow{g} & \mathbf{BG} \end{array}$$

For $G = \mathbf{B}A$, a *connection on a 2-bundle* (not necessarily flat) is a lift

$$\begin{array}{ccc} & & [\mathbf{P}_2(-), \mathbf{B}^2A] \\ & \nearrow \nabla_{\text{flat}} & \downarrow \\ C(U) & \xrightarrow{g} & \mathbf{B}G \end{array}$$

We do not state the last definition for general Lie 2-groups G . The reason is that for general G 2-anafunctors out of $\mathbf{P}_2(X)$ do not produce the fully general notion of 2-connections that we are after, but yield a special case in between flatness and non-flatness: the case where precisely the 2-form curvature-components vanish, while the 3-form curvature part is unrestricted. This case is important in itself and discussed in detail below. Only for G of the form $\mathbf{B}A$ does the 2-form curvature necessarily vanish anyway, so that in this case the definition by morphisms out of $\mathbf{P}_2(X)$ happens to already coincide with the proper general one. This serves in the following theorem as an illustration for the toolset that we are exposing, but for the purposes of introducing the full notion of ∞ -Chern-Weil theory we will rather focus on flat 2-connections, and then show below how using these one does arrive at a functorial definition of 1-connections that does generalize to the fully general definition of ∞ -connections.

Proposition 1.2.118. *Let $\{U_i \rightarrow X\}$ be a good open cover, a cocycle $C(U) \rightarrow [\mathbf{P}_2(-), \mathbf{B}^2A]$ is a cocycle in Čech-Deligne cohomology in degree 3.*

Moreover, we have a natural equivalence of bicategories

$$[\text{CartSp}^{\text{op}}, 2\text{Grpd}][C(U), [\mathbf{P}_2(-), \mathbf{B}^2U(1)]] \simeq U(1)\text{Gerby}(X),$$

where on the right we have the bicategory of $U(1)$ -bundle gerbes with connection [Gaj97].

In particular the equivalence classes of cocycles form the degree-3 ordinary differential cohomology of X :

$$H_{\text{diff}}^3(X, \mathbb{Z}) \simeq \pi_0([C(U), [\mathbf{P}_2(-), \mathbf{B}^2U(1)]].$$

A cocycle as above naturally corresponds to a 2-anafunctor

$$\begin{array}{ccc} Q & \longrightarrow & \mathbf{B}^2U(1) \\ \downarrow \simeq & & \\ \mathbf{P}_2(X) & & \end{array}$$

The value of this on 2-morphisms in $\mathbf{P}_2(X)$ is the higher parallel transport of the connection on the 2-bundle. This appears for instance in the action functional of the sigma model that describes strings charged under a Kalb-Ramond field.

The following example of a flat nonabelian 2-bundle is very degenerate as far as 2-bundles go, but does contain in it the seed of a full understanding of connections on 1-bundles.

Definition 1.2.119. For G a Lie group, its inner automorphism 2-group $\text{INN}(G)$ is as a groupoid the universal G -bundle $\mathbf{E}G$, but regarded as a 2-group with the group structure coming from the crossed module $[G \xrightarrow{\text{Id}} G]$.

The depiction of the delooping 2-groupoid $\mathbf{BINN}(G)$ is

$$\mathbf{BINN}(G) = \left\{ \begin{array}{ccc} & * & \\ g_1 \nearrow & & \searrow g_2 \\ * & \Downarrow k & * \\ & \xrightarrow{kg_2g_1} & \end{array} \mid g_1, g_2 \in G, k \in G \right\}.$$

This is the Lie 2-group whose Lie 2-algebra $\text{inn}(\mathfrak{g})$ is the one whose Chevalley-Eilenberg algebra is the Weil algebra of \mathfrak{g} .

Example 1.2.120. By the above theorem we have that there is a bijection of sets

$$\{\Pi_2(X) \rightarrow \mathbf{BINN}(G)\} \simeq \Omega^1(X, \mathfrak{g})$$

of flat $\mathbf{INN}(G)$ -valued 2-connections and Lie-algebra valued 1-forms. Under the identifications of this theorem this identification works as follows:

- the 1-form component of the 2-connection is A ;
- the vanishing of the 2-form component of the 2-curvature $F_2(A, B) = F_A + B$ identifies the 2-form component of the 2-connection with the curvature 2-form, $B = -F_A$;
- the vanishing of the 3-form component of the 3-curvature $F_3(A, B) = dB + [A \wedge B] = d_A + [A \wedge F_A]$ is the Bianchi identity satisfied by any curvature 2-form.

This means that 2-connections with values in $\mathbf{INN}(G)$ actually model 1-connections *and* keep track of their curvatures. Using this we see in the next section a general abstract definition of connections on 1-bundles that naturally supports the Chern-Weil homomorphism.

1.2.6.1.3 Curvature characteristics of 1-bundles We now describe connections on 1-bundles in terms of their *flat curvature 2-bundles*.

Throughout this section G is a Lie group, \mathbf{BG} its delooping 2-groupoid and $\mathbf{INN}(G)$ its inner automorphism 2-group and $\mathbf{BINN}(G)$ the corresponding delooping Lie 2-groupoid.

Definition 1.2.121. Define the smooth groupoid $\mathbf{BG}_{\text{diff}} \in [\text{CartSp}^{\text{op}}, \text{Grpd}]$ as the pullback

$$\mathbf{BG}_{\text{diff}} = \mathbf{BG} \times_{\mathbf{BINN}(G)} \mathbf{BINN}(G).$$

This is the groupoid-valued presheaf which assigns to $U \in \text{CartSp}$ the groupoid whose objects are commuting diagrams

$$\begin{array}{ccc} U & \longrightarrow & \mathbf{BG} \\ \downarrow & & \downarrow \\ \Pi_2(U) & \longrightarrow & \mathbf{BINN}(G) \end{array},$$

where the vertical morphisms are the canonical inclusions discussed above, and whose morphisms are compatible pairs of natural transformations

$$\begin{array}{ccc} U & \begin{array}{c} \xrightarrow{\quad} \\ \downarrow \\ \xrightarrow{\quad} \end{array} & \mathbf{BG} \\ \downarrow & & \downarrow \\ \Pi_2(U) & \begin{array}{c} \xrightarrow{\quad} \\ \downarrow \\ \xrightarrow{\quad} \end{array} & \mathbf{BINN}(G) \end{array},$$

of the horizontal morphisms.

By the above theorems, we have over any $U \in \text{CartSp}$ that

- an object in $\mathbf{BG}_{\text{diff}}(U)$ is a 1-form $A \in \Omega^1(U, \mathfrak{g})$;
- amorphism $A_1 \xrightarrow{(g, a)} A_2$ is labeled by a function $g \in C^\infty(U, G)$ and a 1-form $a \in \Omega^1(U, \mathfrak{g})$ such that

$$A_2 = g^{-1} A_1 g + g^{-1} dg + a.$$

Notice that this can always be uniquely solved for a , so that the genuine information in this morphism is just the data given by g .

- there are *no* nontrivial 2-morphisms, even though $\mathbf{BINN}(G)$ is a 2-groupoid: since \mathbf{BG} is just a 1-groupoid this is enforced by the commutativity of the above diagram.

From this it is clear that

Proposition 1.2.122. *The projection $\mathbf{BG}_{\text{diff}} \xrightarrow{\sim} \mathbf{BG}$ is a weak equivalence.*

So $\mathbf{BG}_{\text{diff}}$ is a resolution of \mathbf{BG} . We will see that it is the resolution that supports 2-anafunctors out of \mathbf{BG} which represent curvature characteristic classes.

Definition 1.2.123. For $X \xleftarrow{\cong} C(U) \rightarrow \mathbf{BU}(1)$ a cocycle for a $U(1)$ -principal bundle $P \rightarrow X$, we call a lift ∇_{ps} in

$$\begin{array}{ccc} & & \mathbf{BG}_{\text{diff}} \\ & \nearrow \nabla_{\text{ps}} & \downarrow \\ C(U) & \xrightarrow{g} & \mathbf{BG} \end{array}$$

a *pseudo-connection* on P .

Pseudo-connections in themselves are not very interesting. But notice that every ordinary connection is in particular a pseudo-connection and we have an inclusion morphism of smooth groupoids

$$\mathbf{BG}_{\text{conn}} \hookrightarrow \mathbf{BG}_{\text{diff}} .$$

This inclusion plays a central role in the theory. The point is that while $\mathbf{BG}_{\text{diff}}$ is such a boring extension of \mathbf{BG} that it is actually equivalent to \mathbf{BG} , there is no inclusion of $\mathbf{BG}_{\text{conn}}$ into \mathbf{BG} , but there is into $\mathbf{BG}_{\text{diff}}$. This is the kind of situation that resolutions are needed for.

It is useful to look at some details for the case that G is an abelian group such as the circle group $U(1)$. In this abelian case the 2-groupoids $\mathbf{BU}(1)$, $\mathbf{B}^2U(1)$, $\mathbf{BINN}(U(1))$, etc., that so far we noticed are given by crossed complexes are actually given by ordinary chain complexes: we write

$$\Xi : \text{Ch}_{\bullet}^+ \rightarrow \text{sAb} \rightarrow \text{KanCplx}$$

for the Dold-Kan correspondence map that identifies chain complexes with simplicial abelian group and then considers their underlying Kan complexes. Using this map we have the following identifications of our 2-groupoid valued presheaves with complexes of group-valued sheaves

$$\mathbf{BU}(1) = \Xi[C^{\infty}(-, U(1)) \rightarrow 0]$$

$$\mathbf{B}^2U(1) = \Xi[C^{\infty}(-, U(1)) \rightarrow 0 \rightarrow 0]$$

$$\mathbf{BINN}U(1) = \Xi[C^{\infty}(-, U(1)) \xrightarrow{\text{Id}} C^{\infty}(-, U(1)) \rightarrow 0] .$$

Observation 1.2.124. For $G = A$ an abelian group, in particular the circle group, there is a canonical morphism $\mathbf{BINN}(U(1)) \rightarrow \mathbf{BBU}(1)$.

On the level of chain complexes this is the evident chain map

$$\begin{array}{ccccc} [C^{\infty}(-, U(1)) & \xrightarrow{\text{Id}} & C^{\infty}(-, U(1)) & \longrightarrow & 0 \\ \downarrow & & \downarrow & & \downarrow \\ [C^{\infty}(-, U(1)) & \longrightarrow & 0 & \longrightarrow & 0] \end{array} .$$

On the level of 2-groupoids this is the map that forgets the labels on the 1-morphisms

$$\left\{ \begin{array}{ccc} & * & \\ g_1 \nearrow & & \searrow g_2 \\ * & \xrightarrow{k g_2 g_1} & * \\ & \Downarrow k & \end{array} \right\} \mapsto \left\{ \begin{array}{ccc} & * & \\ \text{Id} \nearrow & & \searrow \text{Id} \\ * & \xrightarrow{\text{Id}} & * \\ & \Downarrow k & \end{array} \right\}$$

In terms of this map $\text{INN}(U(1))$ serves to interpolate between the single and the double delooping of $U(1)$. In fact the sequence of 2-functors

$$\mathbf{B}U(1) \rightarrow \mathbf{BINN}(U(1)) \rightarrow \mathbf{B}^2U(1)$$

is a model for the universal $\mathbf{B}U(1)$ -principal 2-bundle

$$\mathbf{B}U(1) \rightarrow \mathbf{E}B\mathbf{U}(1) \rightarrow \mathbf{B}^2U(1).$$

This happens to be an exact sequence of 2-groupoids. Abstractly, what really matters is rather that it is a fiber sequence, meaning that it is exact in the correct sense inside the ∞ -category $\text{Smooth}\infty\text{Grpd}$. For our purposes it is however relevant that this particular model is exact also in the ordinary sense in that we have an ordinary pullback diagram

$$\begin{array}{ccc} \mathbf{B}U(1) & \longrightarrow & * \\ \downarrow & & \downarrow \\ \mathbf{BINN}(U(1)) & \longrightarrow & \mathbf{B}^2U(1) \end{array},$$

exhibiting $\mathbf{B}U(1)$ as the kernel of $\mathbf{BINN}(U(1)) \rightarrow \mathbf{B}^2U(1)$.

We shall be interested in the pasting composite of this diagram with the one defining $\mathbf{B}G_{\text{diff}}$ over a domain U :

$$\begin{array}{ccccc} U & \longrightarrow & \mathbf{B}U(1) & \longrightarrow & * \\ \downarrow & & \downarrow & & \downarrow \\ \mathbf{\Pi}_2(U) & \longrightarrow & \mathbf{BINN}(U(1)) & \longrightarrow & \mathbf{B}^2U(1) \end{array},$$

The total outer diagram appearing this way is a component of the following (generalized) Lie 2-groupoid.

Definition 1.2.125. Set

$$\mathfrak{b}_{\text{dR}}\mathbf{B}^2U(1) := * \times_{\mathbf{B}^2U(1)} \mathfrak{b}\mathbf{B}^2U(1).$$

Over any $U \in \text{CartSp}$ this is the 2-groupoid whose objects are sets of diagrams

$$\begin{array}{ccc} U & \longrightarrow & * \\ \downarrow & & \downarrow \\ \mathbf{\Pi}_2(U) & \longrightarrow & \mathbf{B}^2U(1) \end{array}.$$

This are equivalently just morphisms $\mathbf{\Pi}_2(U) \rightarrow \mathbf{B}^2U(1)$, which by the above theorems we may identify with closed 2-forms $B \in \Omega_{\text{cl}}^2(U)$.

The morphisms $B_1 \rightarrow B_2$ in $\mathfrak{b}_{\text{dR}}\mathbf{B}^2U(1)$ over U are compatible pseudonatural transformations of the horizontal morphisms

$$\begin{array}{ccc} U & \xrightarrow{\quad} & * \\ \downarrow & \curvearrowright & \downarrow \\ \mathbf{\Pi}_2(U) & \xrightarrow{\quad} & \mathbf{BINN}(G) \end{array},$$

which means that they are pseudonatural transformations of the bottom morphism whose components over the points of U vanish. These identify with 1-forms $\lambda \in \Omega^1(U)$ such that $B_2 = B_1 + d_{\text{dR}}\lambda$. Finally the 2-morphisms would be modifications of these, but the commutativity of the above diagram constrains these to be trivial.

In summary this shows that

Proposition 1.2.126. *Under the Dold-Kan correspondence $\mathfrak{b}_{\text{dR}}\mathbf{B}^2U(1)$ is the sheaf of truncated de Rham complexes*

$$\mathfrak{b}_{\text{dR}}\mathbf{B}^2U(1) = \Xi[\Omega^1(-) \xrightarrow{d_{\text{dR}}} \Omega_{\text{cl}}^2(-)].$$

Corollary 1.2.127. *Equivalence classes of 2-anafunctors*

$$X \rightarrow \mathfrak{b}_{\text{dR}}\mathbf{B}^2U(1)$$

are canonically in bijection with the degree 2 de Rham cohomology of X .

Notice that – while every globally defined closed 2-form $B \in \Omega_{\text{cl}}^2(X)$ defines such a 2-anafunctor – not every such 2-anafunctor comes from a globally defined closed 2-form. Some of them assign closed 2-forms B_i to patches U_i , that differ by differentials $B_j - B_i = d_{\text{dR}}\lambda_{ij}$ of 1-forms λ_{ij} on double overlaps, which themselves satisfy on triple intersections the cocycle condition $\lambda_{ij} + \lambda_{jk} = \lambda_{ik}$. But (using a partition of unity) these non-globally defined forms are always equivalent to globally defined ones.

This simple technical point turns out to play a role in the abstract definition of connections on ∞ -bundles: generally, for all $n \in \mathbb{N}$ the cocycles given by globally defined forms in $\mathfrak{b}_{\text{dR}}\mathbf{B}^nU(1)$ constitute curvature characteristic forms of *genuine* connections. The non-globally defined forms *also* constitute curvature invariants, but of pseudo-connections. The way the abstract theory finds the genuine connections inside all pseudo-connections is by the fact that we may find for each cocycle in $\mathfrak{b}_{\text{dR}}\mathbf{B}^nU(1)$ an equivalent one that does come from a globally defined form.

Observation 1.2.128. There is a canonical 2-anafunctor $\hat{c}_1^{\text{dR}} : \mathbf{BU}(1) \rightarrow \mathfrak{b}_{\text{dR}}\mathbf{B}^2U(1)$

$$\begin{array}{ccc} \mathbf{BU}(1)_{\text{diff}} & \longrightarrow & \mathfrak{b}_{\text{dR}}\mathbf{B}^2U(1) , \\ \downarrow \simeq & & \\ \mathbf{BU}(1) & & \end{array}$$

where the top morphism is given by forming the -composite with the universal $\mathbf{BU}(1)$ -principal 2-bundle, as described above.

For emphasis, notice that this span is governed by a presheaf of diagrams that over $U \in \text{CartSp}$ is of the form

$$\begin{array}{ccc} U & \longrightarrow & \mathbf{BU}(1) & \text{transition function} . \\ \downarrow & & \downarrow & \\ \mathbf{\Pi}_2(U) & \longrightarrow & \mathbf{BINN}(U) & \text{connection} \\ \downarrow & & \downarrow & \\ \mathbf{\Pi}_2(U) & \longrightarrow & \mathbf{B}^2U(1) & \text{curvature} \end{array}$$

The top morphisms are the components of the presheaf $\mathbf{BU}(1)$. The top squares are those of $\mathbf{BU}(1)_{\text{diff}}$. Forming the bottom square is forming the bottom morphism, which necessarily satisfies the constraint that makes it a components of $\mathfrak{b}\mathbf{B}^2U(1)$.

The interpretation of the stages is as indicated in the diagram:

1. the top morphism is the transition function of the underlying bundle;

2. the middle morphism is a choice of (pseudo-)connection on that bundle;
3. the bottom morphism picks up the curvature of this connection.

We will see that full ∞ -Chern-Weil theory is governed by a slight refinement of presheaves of essentially this kind of diagram. We will also see that the three stage process here is really an incarnation of the computation of a connecting homomorphism, reflecting the fact that behind the scenes the notion of *curvature* is exhibited as the obstruction cocycle to lifts from bare bundles to flat bundles.

Observation 1.2.129. For $X \xleftarrow{\simeq} C(U) \xrightarrow{g} \mathbf{BU}(1)$ the cocycle for a $U(1)$ -principal bundle as described above, the composition of 2-anafunctors of g with \hat{c}_1^{dR} yields a cocycle for a 2-form $\hat{c}_1^{\text{dR}}(g)$

$$\begin{array}{ccccc}
 & & \mathbf{BU}(1)_{\text{conn}} & & \\
 & \nearrow \nabla & \downarrow & & \\
 C(V) & \longrightarrow & \mathbf{BU}(1)_{\text{diff}} & \longrightarrow & \flat_{\text{dR}} \mathbf{B}^2 U(1) \\
 \downarrow \simeq & & \downarrow \simeq & & \\
 C(U) & \xrightarrow{g} & \mathbf{BU}(1) & & \\
 \downarrow \simeq & & & & \\
 X & & & &
 \end{array}$$

If we take $\{U_i \rightarrow X\}$ to be a good open cover, then we may assume $V = U$. We know we can always find a pseudo-connection $C(V) \rightarrow \mathbf{BU}(1)_{\text{diff}}$ that is actually a genuine connection on a bundle in that it factors through the inclusion $\mathbf{BU}(1)_{\text{conn}} \rightarrow \mathbf{BU}(1)_{\text{diff}}$ as indicated.

The corresponding total map $c_1^{\text{dR}}(g)$ represented by $\hat{c}_1^{\text{dR}}(\nabla)$ is the cocycle for the curvature 2-form of this connection. This represents the first Chern class of the bundle in de Rham cohomology.

For X, A smooth 2-groupoids, write $\mathbf{H}(X, A)$ for the 2-groupoid of 2-anafunctors between them.

Corollary 1.2.130. *Let $H_{\text{dR}}^2(X) \rightarrow \mathbf{H}(X, \flat_{\text{dR}} \mathbf{B}^2 U(1))$ be a choice of one closed 2-form representative for each degree-2 de Rham cohomology-class of X . Then the pullback groupoid $\mathbf{H}_{\text{diff}}(X, \mathbf{BU}(1))$ in*

$$\begin{array}{ccc}
 \mathbf{H}_{\text{conn}}(X, \mathbf{BU}(1)) & \longrightarrow & H_{\text{dR}}^2(X) \\
 \downarrow & & \downarrow \\
 \mathbf{H}(X, \mathbf{BU}(1)_{\text{diff}}) & \longrightarrow & \mathbf{H}(X, \flat_{\text{dR}} \mathbf{B}^2 U(1)) \\
 \downarrow \simeq & & \\
 \mathbf{H}(X, \mathbf{BU}(1)) \simeq U(1)\text{Bund}(X) & &
 \end{array}$$

is equivalent to disjoint union of groupoids of $U(1)$ -bundles with connection whose curvatures are the chosen 2-form representatives.

1.2.6.1.4 Circle n -bundles with connection For A an abelian group there is a straightforward generalization of the above constructions to $(G = \mathbf{B}^{n-1}A)$ -principal n -bundles with connection for all $n \in \mathbb{N}$. We spell out the ingredients of the construction in a way analogous to the above discussion. A first-principles derivation of the objects we consider here below in 4.4.16.

This is content that appeared partly in [SSS09c], [FSS10]. We restrict attention to the circle n -group $G = \mathbf{B}^{n-1}U(1)$.

There is a familiar traditional presentation of ordinary differential cohomology in terms of Čech-Deligne cohomology. We briefly recall how this works and then indicate how this presentation can be derived along the above lines as a presentation of circle n -bundles with connection.

Definition 1.2.131. For $n \in \mathbb{N}$ the *Deligne-Beilinson complex* is the chain complex of sheaves (on CartSp for our purposes here) of abelian groups given as follows

$$\mathbb{Z}(n+1)_D^\infty = \left[\begin{array}{cccccc} C^\infty(-, \mathbb{R}/\mathbb{Z}) & \xrightarrow{d_{\text{dR}}} & \Omega^1(-) & \xrightarrow{d_{\text{dR}}} & \dots & \xrightarrow{d_{\text{dR}}} & \Omega^{n-1}(-) & \xrightarrow{d_{\text{dR}}} & \Omega^n(-) \\ n & & n-1 & & \dots & & 1 & & 0 \end{array} \right].$$

This definition goes back to [Del71] [Bel85]. The complex is similar to the n -fold shifted de Rham complex, up to two important differences.

- In degree n we have the sheaf of $U(1)$ -valued functions, not of \mathbb{R} -valued functions (= 0-forms). The action of the de Rham differential on this is often written $d\log : C^\infty(-, U(1)) \rightarrow \Omega^1(-)$. But if we think of $U(1) \simeq \mathbb{R}/\mathbb{Z}$ then it is just the ordinary de Rham differential applied to any representative in $C^\infty(-, \mathbb{R})$ of an element in $C^\infty(-, \mathbb{R}/\mathbb{Z})$.
- In degree 0 we do not have closed differential n -forms (as one would have for the de Rham complex shifted into non-negative degree), but all n -forms.

As before, we may use of the Dold-Kan correspondence $\Xi : \text{Ch}_\bullet^+ \xrightarrow{\simeq} \text{sAb} \xrightarrow{U} \text{sSet}$ to identify sheaves of chain complexes with simplicial sheaves. We write

$$\mathbf{B}^n U(1)_{\text{conn}} := \Xi \mathbb{Z}(n+1)_D^\infty$$

for the simplicial presheaf corresponding to the Deligne complex.

Then for $\{U_i \rightarrow X\}$ a good open cover, the Deligne cohomology of X in degree $(n+1)$ is

$$H_{\text{diff}}^{n+1}(X) = \pi_0[\text{CartSp}^{\text{op}}, \text{sSet}](C(\{U_i\}), \mathbf{B}^n U(1)_{\text{conn}}).$$

Further using the Dold-Kan correspondence, this is equivalently the cohomology of the Čech-Deligne double complex. A cocycle in degree $(n+1)$ then is a tuple

$$(g_{i_0, \dots, i_n}, \dots, A_{ijk}, B_{ij}, C_i)$$

with

- $C_i \in \Omega^n(U_i)$;
- $B_{ij} \in \Omega^{n-1}(U_i \cap U_j)$;
- $A_{ijk} \in \Omega^{n-2}(U_i \cap U_j \cap U_k)$
- and so on...
- $g_{i_0, \dots, i_n} \in C^\infty(U_{i_0} \cap \dots \cap U_{i_n}, U(1))$

satisfying the cocycle condition

$$(d_{\text{dR}} + (-1)^{\text{deg}} \delta)(g_{i_0, \dots, i_n}, \dots, A_{ijk}, B_{ij}, C_i) = 0,$$

where $\delta = \sum_i (-1)^i p_i^*$ is the alternating sum of the pullback of forms along the face maps of the Čech nerve.

This is a sequence of conditions of the form

- $C_i - C_j = dB_{ij}$;

- $B_{ij} - B_{ik} + B_{jk} = dA_{ijk}$;
- and so on
- $(\delta g)_{i_0, \dots, i_{n+1}} = 0$.

For low n we have seen these conditions in the discussion of line bundles and of line 2-bundles (bundle gerbes) with connection above. Generally, for any $n \in \mathbb{N}$, this is Čech-cocycle data for a *circle n -bundle* with connection, where

- C_i are the local connection n -forms;
- g_{i_0, \dots, i_n} is the transition function of the circle n -bundle.

We now indicate how the Deligne complex may be derived from differential refinement of cocycles for circle n -bundles along the lines of the above discussions. To that end, write

$$\mathbf{B}^n U(1)_{\text{ch}} := \Xi U(1)[n],$$

for the simplicial presheaf given under the Dold-Kan correspondence by the chain complex

$$U(1)[n] = (C^\infty(-, U(1)) \rightarrow 0 \rightarrow \dots \rightarrow 0)$$

with the sheaf represented by $U(1)$ in degree n .

Proposition 1.2.132. *For $\{U_i \rightarrow X\}$ an open cover of a smooth manifold X and $C(\{U_i\})$ its Čech nerve, ∞ -anafunctors*

$$\begin{array}{ccc} C(\{U_i\}) & \xrightarrow{g} & \mathbf{B}^n U(1) \\ \downarrow \simeq & & \\ X & & \end{array}$$

are in natural bijection with tuples of smooth functions

$$g_{i_0 \dots i_n} : U_{i_0} \cap \dots \cap U_{i_n} \rightarrow \mathbb{R}/\mathbb{Z}$$

satisfying

$$(\partial g)_{i_0 \dots i_{n+1}} := \sum_{k=0}^n g_{i_0 \dots i_{k-1} i_k \dots i_n} = 0,$$

that is, with cocycles in degree- n Čech cohomology on U with values in $U(1)$.

Natural transformations

$$\begin{array}{ccc} C(\{U_i\}) \cdot \Delta^1 & \xrightarrow{(g \xrightarrow{\lambda} g')} & \mathbf{B}^n U(1) \\ \downarrow \simeq & & \\ X \cdot \Delta^1 & & \end{array}$$

are in natural bijection with tuples of smooth functions

$$\lambda_{i_0 \dots i_{n-1}} : U_{i_0} \cap \dots \cap U_{i_{n-1}} \rightarrow \mathbb{R}/\mathbb{Z}$$

such that

$$g'_{i_0 \dots i_n} - g_{i_0 \dots i_n} = (\delta \lambda)_{i_0 \dots i_n},$$

that is, with Čech coboundaries.

The ∞ -bundle $P \rightarrow X$ classified by such a cocycle according to 1.2.5.4 we call a *circle n -bundle*. For $n = 1$ this reproduces the ordinary $U(1)$ -principal bundles that we considered before in 1.2.5.1, for $n = 2$ the bundle gerbes considered in 1.2.5.2 and for $n = 3$ the bundle 2-gerbes discussed in 1.2.5.3.

To equip these circle n -bundles with connections, we consider the differential refinements of $\mathbf{B}^n U(1)_{\text{ch}}$ to be denoted $\mathbf{B}^n U(1)_{\text{diff}}$, $\mathbf{B}^n U(1)_{\text{conn}}$ and $\flat_{\text{dR}} \mathbf{B}^{n+1} U(1)$.

Definition 1.2.133. Write

$$\flat_{\text{dR}} \mathbf{B}^{n+1} U(1)_{\text{chn}} := \Xi \left(\Omega^1(-) \xrightarrow{d_{\text{dR}}} \Omega^2(-) \xrightarrow{d_{\text{dR}}} \dots \xrightarrow{d_{\text{dR}}} \Omega^n(-) \right)$$

– the *truncated de Rham complex* – and

$$\mathbf{B}^n U(1)_{\text{diff}} = \left\{ \begin{array}{ccc} (-) & \longrightarrow & \mathbf{B}^n U(1) \\ \downarrow & & \downarrow \\ \mathbf{\Pi}(-) & \twoheadrightarrow & \mathbf{B}^n \text{INN}(U(1)) \end{array} \right\} = \Xi \left(\begin{array}{ccccccc} C^\infty(-, \mathbb{R}/\mathbb{Z}) & \twoheadrightarrow & \Omega^1(-) & \xrightarrow{d_{\text{dR}}} & \dots & \longrightarrow & \Omega^n(-) \\ & \oplus & \nearrow \text{Id} & & & & \nearrow \text{Id} \\ \Omega^1(-) & \xrightarrow{d_{\text{dR}}} & \dots & \xrightarrow{d_{\text{dR}}} & \Omega^n(-) & & \end{array} \right)$$

and

$$\mathbf{B}^n U(1)_{\text{conn}} = \Xi \left(C^\infty(-, \mathbb{R}/\mathbb{Z}) \xrightarrow{d_{\text{dR}}} \Omega^1(-) \xrightarrow{d_{\text{dR}}} \Omega^2(-) \xrightarrow{d_{\text{dR}}} \dots \xrightarrow{d_{\text{dR}}} \Omega^n(-) \right)$$

– the *Deligne complex*, def. 1.2.131.

Observation 1.2.134. We have a pullback diagram

$$\begin{array}{ccc} \mathbf{B}^n U(1)_{\text{conn}} & \longrightarrow & \Omega_{\text{cl}}^{n+1}(-) \\ \downarrow & & \downarrow \\ \mathbf{B}^n U(1)_{\text{diff}} & \xrightarrow{\text{curry}} & \flat_{\text{dR}} \mathbf{B}^{n-1} U(1) \\ \downarrow \simeq & & \\ \mathbf{B}^n U(1) & & \end{array}$$

in $[\text{CartSp}^{\text{op}}, \text{sSet}]$. This models an ∞ -pullback

$$\begin{array}{ccc} \mathbf{B}^n U(1)_{\text{conn}} & \longrightarrow & \Omega_{\text{cl}}^{n+1}(-) \\ \downarrow & & \downarrow \\ \mathbf{B}^n U(1) & \longrightarrow & \flat_{\text{dR}} \mathbf{B}^{n-1} U(1) \end{array}$$

in the ∞ -topos $\text{Smooth}\infty\text{Grpd}$, and hence for each smooth manifold X (in particular) a homotopy pullback

$$\begin{array}{ccc} \mathbf{H}(X, \mathbf{B}^n U(1)_{\text{conn}}) & \longrightarrow & \Omega_{\text{cl}}^{n+1}(X) \\ \downarrow & & \downarrow \\ \mathbf{H}(X, \mathbf{B}^n U(1)) & \longrightarrow & \mathbf{H}(X, \flat_{\text{dR}} \mathbf{B}^{n-1} U(1)) \end{array}$$

We write

$$H_{\text{diff}}^n(X) := \mathbf{H}(X, \mathbf{B}^n U(1)_{\text{conn}})$$

for the group of cohomology classes on X with coefficients in $\mathbf{B}^n U(1)_{\text{conn}}$. On these cohomology classes the above homotopy pullback diagram reduces to the commutative diagram

$$\begin{array}{ccc}
 & H_{\text{diff}}^{n+1}(X) & \\
 \swarrow & & \searrow \\
 H^{n+1}(X, \mathbb{Z}) & & \Omega_{\text{cl}}^{n+1}(X) \\
 \searrow & & \swarrow \\
 & H^{n+1}(X, \mathbb{R}) \simeq H_{\text{dR}}^{n+1}(X) &
 \end{array}$$

that had appeared above in 1.1.3. But notice that the homotopy pullback of the cocycle n -groupoids contains more information than this projection to cohomology classes.

Objects in $\mathbf{H}(X, \mathbf{B}^n U(1)_{\text{conn}})$ are modeled by ∞ -anafunctors $X \overset{\sim}{\leftarrow} C(\{U_i\}) \rightarrow \mathbf{B}^n U(1)_{\text{conn}}$, and these are in natural bijection with tuples

$$(C_i, B_{i_0 i_1}, A_{i_0 i_1 i_2}, \dots, Z_{i_0 \dots i_{n-1}}, g_{i_0 \dots i_n}),$$

where $C_i \in \Omega^n(U_i)$, $B_{i_0 i_1} \in \Omega^{n-1}(U_{i_0} \cap U_{i_1})$, etc., such that

$$C_{i_0} - C_{i_1} = dB_{i_0 i_1}$$

and

$$B_{i_0 i_1} - B_{i_0 i_2} + B_{i_1 i_2} = dA_{i_0 i_1 i_2},$$

etc. This is a cocycle in Čech-Deligne cohomology. We may think of this as encoding a circle n -bundle with connection. The forms (C_i) are the local *connection n -forms*.

The definition of ∞ -connections on G -principal ∞ -bundles for nonabelian G may be reduced to this definition, by *approximating* every G -cocycle $X \overset{\sim}{\leftarrow} C(\{U_i\}) \rightarrow \mathbf{B}G$ by abelian cocycles in all possible ways, by postcomposing with all possible *characteristic classes* $\mathbf{B}G \overset{\sim}{\leftarrow} \widehat{\mathbf{B}G} \rightarrow \mathbf{B}^n U(1)$ to extract a circle n -bundle from it. This is what we turn to below in 1.2.7.

1.2.6.1.5 Holonomy and canonical action functionals We had started out with motivating differential refinements of bundles and higher bundles by the notion of higher parallel transport. Here we discuss aspects of this for the circle n -bundles

Let Σ be a compact smooth manifold of dimension n . For every smooth function $\Sigma \rightarrow X$ there is a corresponding pullback operation

$$H_{\text{diff}}^{n+1}(X) \rightarrow H_{\text{diff}}^{n+1}(\Sigma)$$

that sends circle n -connections on X to circle n -connections on Σ . But due to its dimension, the curvature $(n+1)$ -form of any circle n -connection on Σ is necessarily trivial. From the definition of homotopy pullback one can show that this implies that every circle n -connection on Σ is equivalent to one which is given by a Čech-Deligne cocycle that involves a globally defined connection n -form ω . The integral of this form over Σ produces a real number. One finds that this is well-defined up to integral shifts. This gives an *n -volume holonomy* map

$$\int_{\Sigma} : \mathbf{H}(\Sigma, \mathbf{B}^n U(1)_{\text{conn}}) \rightarrow U(1).$$

For instance for $n=1$ this is the map that sense an ordinary connection on an ordinary circle bundle over Σ to its ordinary parallel transport along Σ , its line holonomy.

For G any smooth (higher) group, any morphism

$$\hat{c} : \mathbf{B}G_{\text{conn}} \rightarrow \mathbf{B}^n U(1)_{\text{conn}}$$

from the moduli stack of G -connections to that of circle n -connections therefore induces a canonical functional

$$\exp(iS_{\mathbf{c}}(-)) : \mathbf{H}(\Sigma, \mathbf{B}G_{\text{conn}}) \xrightarrow{\mathbf{H}(\Sigma, \hat{\mathbf{c}})} \mathbf{H}(\Sigma, \mathbf{B}^n U(1)_{\text{conn}}) \xrightarrow{f_{\Sigma}} U(1)$$

from the ∞ -groupoid of G -connections on Σ to $U(1)$.

1.2.6.2 Differential cohomology We now indicate how the combination of the *intrinsic cohomology* and the *geometric homotopy* in a locally ∞ -connected ∞ -topos yields a good notion of *differential cohomology in an ∞ -topos*.

Using the defining adjoint ∞ -functors $(\mathbf{\Pi} \dashv \text{Disc} \dashv \Gamma)$ we may reflect the fundamental ∞ -groupoid $\mathbf{\Pi} : \mathbf{H} \rightarrow \infty\text{Grpd}$ from Top back into \mathbf{H} by considering the composite endo-edjunction

$$(\mathbf{\Pi} \dashv \flat) := (\text{Disc} \circ \mathbf{\Pi} \dashv \text{Disc} \circ \Gamma) : \mathbf{H} \rightleftarrows \mathbf{H} .$$

The $(\mathbf{\Pi} \dashv \text{Disc})$ -unit $X \rightarrow \mathbf{\Pi}(X)$ may be thought of as the inclusion of X into its fundamental ∞ -groupoid as the collection of constant paths in X .

As always, the boldface $\mathbf{\Pi}$ is to indicate that we are dealing with a cohesive refinement of the topological structure $\mathbf{\Pi}$. The symbol “ \flat ” (“flat”) is to be suggestive of the meaning of this construction:

For $X \in \mathbf{H}$ any cohesive object, we may think of $\mathbf{\Pi}(X)$ as its cohesive fundamental ∞ -groupoid. A morphism

$$\nabla : \mathbf{\Pi}(X) \rightarrow \mathbf{B}G$$

(hence a G -valued cocycle on $\mathbf{\Pi}(X)$) may be interpreted as assigning:

- to each point $x \in X$ the fiber of the corresponding G -principal ∞ -bundle classified by the composite $g : X \rightarrow \mathbf{\Pi}(X) \xrightarrow{\nabla} \mathbf{B}G$;
- to each path in X an equivalence between the fibers over its endpoints;
- to each homotopy of paths in X an equivalence between these equivalences;
- and so on.

This in turn we may think as being the *flat higher parallel transport* of an ∞ -connection on the bundle classified by $g : X \rightarrow \mathbf{\Pi}(X) \xrightarrow{\nabla} \mathbf{B}G$.

The adjunction equivalence allows us to identify $\flat\mathbf{B}G$ as the coefficient object for this flat differential G -valued cohomology on X :

$$H_{\text{flat}}(X, G) := \pi_0 \mathbf{H}(X, \flat\mathbf{B}G) \simeq \pi_0 \mathbf{H}(\mathbf{\Pi}(X), \mathbf{B}G) .$$

In $\mathbf{H} = \text{Smooth}\infty\text{Grpd}$ and with $G \in \mathbf{H}$ an ordinary Lie group and $X \in \mathbf{H}$ an ordinary smooth manifold, we have that $H_{\text{flat}}(X, G)$ is the set of equivalence classes of ordinary G -principal bundles on X with flat connections.

The $(\text{Disc} \dashv \Gamma)$ -counit $\flat\mathbf{B}G \rightarrow \mathbf{B}G$ provides the forgetful morphism

$$H_{\text{flat}}(X, G) \rightarrow H(X, G)$$

from G -principal ∞ -bundles with flat connection to their underlying principal ∞ -bundles. Not every G -principal ∞ -bundle admits a flat connection. The failure of this to be true - the obstruction to the existence of flat lifts - is measured by the homotopy fiber of the counit, which we shall denote $\flat_{\text{dR}}\mathbf{B}G$, defined by the fact that we have a fiber sequence

$$\flat_{\text{dR}}\mathbf{B}G \rightarrow \flat\mathbf{B}G \rightarrow \mathbf{B}G .$$

As the notation suggests, it turns out that $\flat_{\text{dR}}\mathbf{B}G$ may be thought of as the coefficient object for nonabelian generalized de Rham cohomology. For instance for G an ordinary Lie group regarded as an object in $\mathbf{H} =$

Smooth ∞ Grpd, we have that $b_{\text{dR}}\mathbf{B}G$ is presented by the sheaf $\Omega_{\text{flat}}^1(-, \mathfrak{g})$ of Lie algebra valued differential forms with vanishing curvature 2-form. And for the circle Lie n -group $\mathbf{B}^{n-1}U(1)$ we find that $b_{\text{dR}}\mathbf{B}^nU(1)$ is presented by the complex of sheaves whose abelian sheaf cohomology is de Rham cohomology in degree n . (More precisely, this is true for $n \geq 2$. For $n = 1$ we get just the sheaf of closed 1-forms. This is due to the obstruction-theoretic nature of b_{dR} : as we shall see, in degree 1 it computes 1-form curvatures of groupoid principal bundles, and these are not quotiented by exact 1-forms.) Moreover, in this case our fiber sequence extends not just to the left but also to the right

$$b_{\text{dR}}\mathbf{B}^nU(1) \rightarrow b\mathbf{B}^nU(1) \rightarrow \mathbf{B}^nU(1) \xrightarrow{\text{curv}} b_{\text{dR}}\mathbf{B}^{n+1}U(1).$$

The induced morphism

$$\text{curv}_X : \mathbf{H}(X, \mathbf{B}^nU(1)) \rightarrow \mathbf{H}(X, b_{\text{dR}}\mathbf{B}^{n+1}U(1))$$

we may think of as equipping an $\mathbf{B}^{n-1}U(1)$ -principal n -bundle (equivalently an $(n-1)$ -bundle gerbe) with a connection, and then sending it to the higher curvature class of this connection. The homotopy fibers

$$\mathbf{H}_{\text{diff}}(X, \mathbf{B}^nU(1)) \rightarrow \mathbf{H}(X, \mathbf{B}^nU(1)) \xrightarrow{\text{curv}} \mathbf{H}(X, b_{\text{dR}}\mathbf{B}^{n+1}U(1))$$

of this map therefore have the interpretation of being the cocycle ∞ -groupoids of circle n -bundles with connection. This is the realization in Smooth ∞ Grpd of our general definition of ordinary differential cohomology in an ∞ -topos.

All these definitions make sense in full generality for any locally ∞ -connected ∞ -topos. We used nothing but the existence of the triple of adjoint ∞ -functors $(\Pi \dashv \text{Disc} \dashv \Gamma) : \mathbf{H} \rightarrow \infty\text{Grpd}$. We shall show for the special case that $\mathbf{H} = \text{Smooth}\infty\text{Grpd}$ and X an ordinary smooth manifold, that this general abstract definition reproduces ordinary differential cohomology over smooth manifolds as traditionally considered.

The advantage of the general abstract reformulation is that it generalizes the ordinary notion naturally to base objects that may be arbitrary smooth ∞ -groupoids. This gives in particular the ∞ -Chern-Weil homomorphism in an almost tautological form:

for $G \in \mathbf{H}$ any ∞ -group object and $\mathbf{B}G \in \mathbf{H}$ its delooping, we may think of a morphism

$$\mathbf{c} : \mathbf{B}G \rightarrow \mathbf{B}^nU(1)$$

as a representative of a characteristic class on G , in that this induces a morphism

$$[\mathbf{c}(-)] : H(X, G) \rightarrow H^n(X, U(1))$$

from G -principal ∞ -bundles to degree- n cohomology-classes. Since the classification of G -principal ∞ -bundles by cocycles is entirely general, we may equivalently think of this as the $\mathbf{B}^{n-1}U(1)$ -principal ∞ -bundle $P \rightarrow \mathbf{B}G$ given as the homotopy fiber of \mathbf{c} . A famous example is the Chern-Simons circle 3-bundle (bundle 2-gerbe) for G a simply connected Lie group.

By postcomposing further with the canonical morphism $\text{curv} : \mathbf{B}^nU(1) \rightarrow b_{\text{dR}}\mathbf{B}^{n+1}U(1)$ this gives in total a *differential characteristic class*

$$\mathbf{c}_{\text{dR}} : \mathbf{B}G \xrightarrow{\mathbf{c}} \mathbf{B}^nU(1) \xrightarrow{\text{curv}} b_{\text{dR}}\mathbf{B}^{n+1}U(1)$$

that sends a G -principal ∞ -bundle to a class in de Rham cohomology

$$[\mathbf{c}_{\text{dR}}] : H(X, G) \rightarrow H_{\text{dR}}^{n+1}(X).$$

This is the generalization of the plain Chern-Weil homomorphism associated with the characteristic class c . In cases accessible by traditional theory, it is well known that this may be refined to what are called the assignment of *secondary characteristic classes* to G -principal bundles with connection, taking values in ordinary differential cohomology

$$[\hat{\mathbf{c}}] : H_{\text{conn}}(X, G) \rightarrow H_{\text{diff}}^{n+1}(X).$$

We will discuss that in the general formulation this corresponds to finding objects $\mathbf{B}G_{\text{conn}}$ that lift all curvature characteristic classes to their corresponding circle n -bundles with connection, in that it fits into the diagram

$$\begin{array}{ccccc}
\mathbf{H}(-, \mathbf{B}G_{\text{conn}}) & \longrightarrow & \prod_i \mathbf{H}_{\text{diff}}(-, \mathbf{B}^{n_i}U(1)) & \longrightarrow & \prod_i H_{\text{dR}}^{n_i+1}(-) \\
\downarrow & & \downarrow & & \downarrow \\
\mathbf{H}(-, \mathbf{B}G) & \longrightarrow & \prod_i \mathbf{H}(-, \mathbf{B}^{n_i}U(1)) & \xrightarrow{\text{curv}} & \prod_i \mathbf{H}(-, \mathbf{b}_{\text{dR}}\mathbf{B}^{n_i+1}U(1))
\end{array}$$

The cocycles in $\mathbf{H}_{\text{conn}}(X, \mathbf{B}G) := \mathbf{H}(X, \mathbf{B}G_{\text{conn}})$ we may identify with ∞ -connections on the underlying principal ∞ -bundles. Specifically for G an ordinary Lie group this captures the ordinary notion of connection on a bundle, for G Lie 2-group it captures the notion of connection on a 2-bundle/gerbe.

1.2.6.3 Higher geometric prequantization Observation. There is a canonical ∞ -action γ of $\text{Aut}_{\mathbf{H}/\mathbf{B}G}(g)$ on the space of ∞ -sections $\Gamma_X(P \times_G V)$.

Claim. Since $\text{Sh}_{\infty}(\text{SmthMfd})$ is cohesive, there is a notion of *differential refinement* of the above discussion, yielding *connections* on ∞ -bundles.

Example. Let $\mathbb{C} \rightarrow \mathbb{C}/U(1) \rightarrow \mathbf{B}U(1)$ be the canonical complex-linear circle action. Then

- $g_{\text{conn}} : X \rightarrow \mathbf{B}U(1)_{\text{conn}}$ classifies a circle bundle with connection, a *prequantum line bundle* of its curvature 2-form;
- $\Gamma_X(P \times_{U(1)} \mathbb{C})$ is the corresponding space of smooth sections;
- γ is the $\exp(\text{Poisson bracket})$ -group action of prequantum operators, containing the Heisenberg group action.

Example. Let $\mathbf{B}U \rightarrow \mathbf{B}PU \rightarrow \mathbf{B}^2U(1)$ be the canonical 2-circle action. Then

- $g_{\text{conn}} : X \rightarrow \mathbf{B}^2U(1)_{\text{conn}}$ classifies a circle 2-bundle with connection, a *prequantum line 2-bundle* of its curvature 3-form;
- $\Gamma_X(P \times_{\mathbf{B}U(1)} \mathbf{B}U)$ is the corresponding groupoid of smooth sections = twisted bundles;
- γ is the $\exp(2\text{-plectic bracket})$ -2-group action of 2-plectic geometry, containing the *Heisenberg 2-group* action.

1.2.7 Characteristic classes

We discuss explicit presentations of *characteristic classes* of principal n -bundles for low values of n and for low degree of the characteristic class.

- General concept
- Examples
 - example 1.2.135 – First Chern class of unitary 1-bundles
 - example 1.2.136 – Dixmier-Douady class of circle 2-bundles (of bundle gerbes)
 - example 1.2.137 – Obstruction class of central extension
 - example 1.2.138 – First Stiefel-Whitney class of an O-principal bundle
 - example 1.2.139 – Second Stiefel-Whitney class of an SO-principal bundle
 - example 1.2.140 – Bockstein homomorphism
 - example 1.2.141 – Third integral Stiefel-Whitney class
 - example 1.2.142 – First Pontryagin class of Spin-1-bundles and twisted string-2-bundles

In the context of higher (smooth) groupoids the notion of characteristic class is conceptually very simple: for G some n -group and $\mathbf{B}G$ the corresponding one-object n -groupoid, a characteristic class of degree $k \in \mathbb{N}$ with coefficients in some abelian (Lie-)group A is presented simply by a morphism

$$c : \mathbf{B}G \rightarrow \mathbf{B}^k A$$

of cohesive ∞ -groupoids. For instance if $A = \mathbb{Z}$ such a morphism represents a *universal integral characteristic class* on $\mathbf{B}G$. Then for

$$g : X \rightarrow \mathbf{B}G$$

any morphism of (smooth) ∞ -groupoids that classifies a given G -principal n -bundle $P \rightarrow X$, as discussed above in 1.2.5, the corresponding characteristic class of P (equivalently of g) is the class of the composite

$$c(P) : X \xrightarrow{g} \mathbf{B}G \xrightarrow{c} \mathbf{B}^k A ,$$

in the cohomology group $H^k(X, A)$ of the ambient ∞ -topos.

In other words, in the abstract language of cohesive ∞ -toposes the notion of characteristic classes of cohesive principal ∞ -bundles is verbatim that of principal fibrations in ordinary homotopy theory. The crucial difference, though, is in the implementation of this abstract formalism.

Namely, as we have discussed previously, all the abstract morphisms $f : A \rightarrow B$ of cohesive ∞ -groupoids here are presented by ∞ -*anafunctors*, hence by spans of genuine morphisms of Kan-complex valued presheaves, whose left leg is a weak equivalence that exhibits a resolution of the source object.

This means that the characteristic map itself is presented by a span

$$\begin{array}{ccc} \widehat{\mathbf{B}G} & \xrightarrow{c} & \mathbf{B}^k A , \\ \downarrow \simeq & & \\ \mathbf{B}G & & \end{array}$$

as is of course the cocycle for the principal n -bundle

$$\begin{array}{ccc} C(U_i) & \xrightarrow{g} & \mathbf{B}G \\ \downarrow \simeq & & \\ X & & \end{array}$$

and the characteristic class $[c(P)]$ of the corresponding principal n -bundle is presented by a (any) span composite

$$\begin{array}{ccccc} C(T_i) & \xrightarrow{\hat{g}} & \widehat{\mathbf{B}G} & \xrightarrow{c} & \mathbf{B}^k A , \\ \downarrow \simeq & & \downarrow \simeq & & \\ C(U_i) & \xrightarrow{g} & \mathbf{B}G & & \\ \downarrow \simeq & & & & \\ X & & & & \end{array}$$

where $C(T_i)$ is, if necessary, a refinement of the cover $C(U_i)$ over which the $\mathbf{B}G$ -cocycle g lifts to a $\widehat{\mathbf{B}G}$ -cocycle as indicated.

Notice the similarity of this situation to that of the discussion of twisted bundles in example 1.2.88. This is not a coincidence: every characteristic class induces a corresponding notion of *twisted n -bundles* and, conversely, every notion of twisted n -bundles can be understood as arising from the failure of a certain characteristic class to vanish.

We discuss now a list of examples.

Example 1.2.135 (first Chern class). Let $N \in \mathbb{N}$. Consider the unitary group $U(n)$. By its definition as a matrix Lie group, this comes canonically equipped with the determinant function

$$\det : U(n) \rightarrow U(1)$$

and by the standard properties of the determinant, this is in fact a group homomorphism. Therefore this has a delooping to a morphism of Lie groupoids

$$\mathbf{B}\det : \mathbf{B}U(n) \rightarrow \mathbf{B}U(1).$$

Under geometric realization this maps to a morphism

$$|\mathbf{B}\det| : BU(n) \rightarrow BU(1) \simeq K(\mathbb{Z}, 2)$$

of topological spaces. This is a characteristic class on the classifying space $BU(n)$: the ordinary *first Chern class*. Hence the morphism $\mathbf{B}\det$ on Lie groupoids is a *smooth refinement* of the ordinary first Chern class.

This smooth refinement acts on smooth $U(n)$ -principal bundles as follows. Postcomposition of a Čech cocycle

$$P : \begin{array}{ccc} C(\{U_i\}) & \xrightarrow{(g_{ij})} & \mathbf{B}U(n) \\ \downarrow \simeq & & \\ X & & \end{array}$$

for a $U(n)$ -principal bundle on a smooth manifold X with this characteristic class yields the cocycle

$$\det P : \begin{array}{ccc} C(\{U_i\}) & \xrightarrow{(g_{ij})} & \mathbf{B}U(n) \xrightarrow{\mathbf{B}\det} \mathbf{B}U(1) \\ \downarrow \simeq & & \\ X & & \end{array}$$

for a circle bundle (or its associated line bundle) with transition functions $(\det(g_{ij}))$: the *determinant line bundle* of P .

We may easily pass to the *differential refinement* of the first Chern class along similar lines. By prop. 1.2.107 the differential refinement $\mathbf{B}U(n)_{\text{conn}} \rightarrow \mathbf{B}U(n)$ of the moduli stack of $U(n)$ -principal bundles is given by the groupoid-valued presheaf which over a test manifold U assigns

$$\mathbf{B}U(n)_{\text{conn}} : U \mapsto \left\{ A \xrightarrow{g} A^g \mid A \in \Omega^1(U, \mathfrak{u}(n)); g \in C^\infty(U, U(n)) \right\}.$$

One checks that $\mathbf{B}\det$ uniquely extends to a morphism of groupoid-valued presheaves $\mathbf{B}\det_{\text{conn}}$

$$\begin{array}{ccc} \mathbf{B}U(n)_{\text{conn}} & \xrightarrow{\mathbf{B}\det_{\text{conn}}} & \mathbf{B}U(1)_{\text{conn}} \\ \downarrow & & \downarrow \\ \mathbf{B}U(n) & \xrightarrow{\mathbf{B}\det} & \mathbf{B}U(1) \end{array}$$

by sending $A \mapsto \text{tr}(A)$. Here the trace operation on the matrix Lie algebra $\mathfrak{u}(n)$ is a unary *invariant polynomial* $\langle - \rangle : \mathfrak{u}(n) \rightarrow \mathfrak{u}(1) \simeq \mathbb{R}$.

Therefore, over a 1-dimensional compact manifold Σ (a disjoint union of circles) the canonical action functional, 1.2.6.1.5, induced by the first Chern class is

$$\exp(iS_{c_1}) : \mathbf{H}(\Sigma, \mathbf{B}U(n)_{\text{conn}}) \xrightarrow{\mathbf{H}(\Sigma, \mathbf{B}\det_{\text{conn}})} \mathbf{H}(\Sigma, \mathbf{B}U(1)_{\text{conn}}) \xrightarrow{f_\Sigma} U(1)$$

sending

$$A \mapsto \exp(i \int_{\Sigma} \text{tr}(A)).$$

This is the action functional of 1-dimensional $U(n)$ -Chern-Simons theory, discussed below in 5.5.4.

It is a basic fact that the cohomology class of line bundles can be identified within the second *integral cohomology* of X . For our purposes here it is instructive to rederive this fact in terms of anafunctors, *lifting gerbes* and twisted bundles.

To that end, consider from example 1.2.87 the equivalence of the 2-group $(\mathbb{Z} \hookrightarrow \mathbb{R})$ with the ordinary circle group, which supports the 2-anafunctor

$$\begin{array}{ccc} \mathbf{B}(\mathbb{Z} \rightarrow \mathbb{R}) & \xrightarrow{c_1} & \mathbf{B}(\mathbb{Z} \rightarrow 1) \equiv \mathbf{B}^2\mathbb{Z} . \\ \downarrow \simeq & & \\ \mathbf{B}U(1) & & \end{array}$$

We see now that this presents an integral characteristic class in degree 2 on $\mathbf{B}U(1)$. Given a cocycle $\{h_{ij} \in C^\infty(U_{ij}, U(1))\}$ for any circle bundle, the postcomposition with this 2-anafunctor amounts to the following:

1. refine the cover, if necessary, to a *good* open cover (where all non-empty U_{i_0, \dots, i_k} are contractible) – we shall still write $\{U_i\}$ now for this good cover;
2. choose on each U_{ij} a (any) lift of the circle-valued functor $h_{ij} : U_{ij} \rightarrow U(1)$ through the quotient map $\mathbb{R} \rightarrow U(1)$ to a function $\hat{h}_{ij} : U_{ij} \rightarrow \mathbb{R}$ – this is always possible over the contractible U_{ij} ;
3. compute the failures of the lifts thus chosen to constitute the cocycle for an \mathbb{R} -principal bundle: these are the elements

$$\lambda_{ijk} := \hat{h}_{ik} \hat{h}_{ij}^{-1} \hat{h}_{jk}^{-1} \in C^\infty(U_{ijk}, \mathbb{Z}),$$

which are indeed \mathbb{Z} -valued (hence constant) smooth functions due to the fact that the original $\{h_{ij}\}$ satisfied its cocycle law;

4. notice that by observation 1.2.83 this yields the construction of the cocycle for a $(\mathbb{Z} \rightarrow \mathbb{R})$ -principal 2-bundle

$$\{\hat{h}_{ij} \in C^\infty(U_{ij}, \mathbb{R}), \lambda_{ijk} \in C^\infty(U_{ijk}, \mathbb{Z})\},$$

which by example 1.2.88 we may also read as the cocycle for a twisted \mathbb{R} -1-bundle, with respect to the central extension $\mathbb{Z} \rightarrow \mathbb{R} \rightarrow U(1)$;

5. finally project out the cocycle for the “lifting \mathbb{Z} -gerbe” encoded by this, which is the $\mathbf{B}\mathbb{Z}$ -principal 2-bundle given by the $\mathbf{B}\mathbb{Z}$ cocycle

$$\{\lambda_{ijk} \in C^\infty(U_{ijk}, \mathbb{Z})\},$$

This last cocycle is manifestly in degree-2 integral Čech cohomology, and hence indeed represents a class in $H^2(X, \mathbb{Z})$. This is the first Chern class of the circle bundle given by $\{h_{ij}\}$. If here $h_{ij} = \det g_{ij}$ is the determinant circle bundle of some unitary bundle, then this is also the first Chern class of that unitary bundle.

Example 1.2.136 (Dixmier-Douady class). The discussion in example 1.2.135 of the first Chern class of a circle 1-bundle has an immediate generalization to an analogous canonical class of circle 2-bundles, def. 1.2.72, hence, by observation 1.2.73, to bundle gerbes. As before, while this amounts to a standard and basic fact, for our purposes it shall be instructive to spell this out in terms of ∞ -anafunctors and twisted principal 2-bundles.

To that end, notice that by delooping the equivalence $\mathbf{B}(\mathbb{Z} \rightarrow \mathbb{R}) \xrightarrow{\cong} \mathbf{B}U(1)$ yields

$$\mathbf{B}^2(\mathbb{Z} \rightarrow \mathbb{R}) \xrightarrow{\cong} \mathbf{B}^2U(1).$$

This says that $\mathbf{B}U(1)$ -principal 2-bundles/bundle gerbes are equivalent to $\mathbf{B}(\mathbb{Z} \rightarrow \mathbb{R})$ -principal 3-bundles, def. 1.2.92.

As before, this supports a canonical integral characteristic class, now in degree 3, presented by the ∞ -anafunctor

$$\begin{array}{c} \mathbf{B}^2(\mathbb{Z} \rightarrow \mathbb{R}) \longrightarrow \mathbf{B}^2(\mathbb{Z} \rightarrow 1) \equiv \mathbf{B}(\mathbb{Z} \rightarrow 1 \rightarrow 1) . \\ \downarrow \simeq \\ \mathbf{B}^2U(1) \end{array}$$

The corresponding class in $H^3(\mathbf{B}U(1), \mathbb{Z})$ is the (smooth lift of) the *universal Dixmier-Douady class*.

Explicitly, for $\{g_{ijk} \in C^\infty(U_{ijk}, U(1))\}$ the Čech cocycle for a circle-2-bundle, def. 1.2.72, this class is computed as the composite of spans

$$\begin{array}{ccccc} C(U_i) & \xrightarrow{(\hat{g}, \lambda)} & \mathbf{B}^2(\mathbb{Z} \rightarrow \mathbb{R}) & \longrightarrow & \mathbf{B}^3\mathbb{Z} , \\ \downarrow \simeq & & \downarrow \simeq & & \\ C(U_i) & \xrightarrow{g} & \mathbf{B}^2U(1) & & \\ \downarrow \simeq & & & & \\ X & & & & \end{array}$$

where we assume for simplicity of notation that the cover $\{U_i \rightarrow X\}$ already has been chosen (possibly after refining another cover) such that all patches and their non-empty intersections are contractible.

Here the lifted cocycle data $\{\hat{g}_{ijk} : U_{ijk} \rightarrow U(1)\}$ is through the quotient map $\mathbb{R} \rightarrow U(1)$ to real valued functions. These lifts will, in general, not satisfy the condition of a cocycle for a $\mathbf{B}\mathbb{R}$ -principal 2-bundle. The failure is uniquely picked up by the functions

$$\lambda_{ijkl} := \hat{g}_{jkl} g_{ijk}^{-1} g_{ijl} g_{ikl}^{-1} \in C^\infty(U_{ijkl}, \mathbb{Z}).$$

By example 1.2.94 this data constitutes the cocycle for a $(\mathbb{Z} \rightarrow \mathbb{R} \rightarrow 1)$ -principal 3-bundle or, by def. 1.2.95 that of a *twisted $\mathbf{B}\mathbb{R}$ -principal 2-bundle*.

The above composite of spans projects out the integral cocycle

$$\lambda_{ijkl} \in C^\infty(U_{ijkl}, \mathbb{Z}),$$

which manifestly gives a class in $H^3(X, \mathbb{Z})$. This is the Dixmier-Douady class of the original circle 3-bundle, the higher analog of the Chern-class of a circle bundle.

Example 1.2.137 (obstruction class of central extension). For $A \rightarrow \hat{G} \rightarrow G$ a central extension of Lie groups, there is a long sequence of (deloopings of) Lie 2-groups

$$\mathbf{B}A \rightarrow \mathbf{B}\hat{G} \rightarrow \mathbf{B}G \xrightarrow{\mathbf{c}} \mathbf{B}^2A,$$

where the characteristic class \mathbf{c} is presented by the ∞ -anafunctor

$$\begin{array}{c} \mathbf{B}(A \rightarrow \hat{G}) \longrightarrow \mathbf{B}(A \rightarrow 1) \equiv \mathbf{B}^2A \\ \downarrow \simeq \\ \mathbf{B}G \end{array}$$

with $(A \rightarrow \hat{G})$ the crossed module from example 1.2.81.

The proof of this is discussed below in prop. 4.4.41.

Example 1.2.138 (first Stiefel-Whitney class). The morphism of groups

$$\mathrm{O}(n) \rightarrow \mathbb{Z}_2$$

which sends every element in the connected component of the unit element of $\mathrm{O}(n)$ to the unit element of \mathbb{Z}_2 and every other element to the non-trivial element of \mathbb{Z}_2 induces a morphism of delooping Lie groupoids

$$\mathbf{w}_1 : \mathbf{BO}(n) \rightarrow \mathbf{B}\mathbb{Z}_2 .$$

This represents the universal smooth *first Stiefel-Whitney class*.

The relation of \mathbf{w}_1 to orientation structure is discussed below in 5.1.2.

Example 1.2.139 (second Stiefel-Whitney class). The exact sequence that characterizes the Spin-group is

$$\mathbb{Z}_2 \rightarrow \mathrm{Spin} \rightarrow \mathrm{SO}$$

induces, by example 1.2.137, a long fiber sequence

$$\mathbf{B}\mathbb{Z}_2 \rightarrow \mathbf{B}\mathrm{Spin} \rightarrow \mathbf{BSO} \xrightarrow{\mathbf{w}_2} \mathbf{B}^2\mathbb{Z}_2 .$$

Here the morphism \mathbf{w}_2 is presented by the ∞ -anafunctor

$$\begin{array}{ccc} \mathbf{B}(\mathbb{Z}_2 \rightarrow \mathrm{Spin}) & \longrightarrow & \mathbf{B}(\mathbb{Z}_2 \rightarrow 1) = \mathbf{B}^2\mathbb{Z}_2 . \\ \downarrow \simeq & & \\ \mathbf{BSO} & & \end{array}$$

This is a smooth incarnation of the *universal second Stiefel-Whitney class*. The $\mathbf{B}\mathbb{Z}_2$ -principal 2-bundle associated by \mathbf{w}_2 to any $\mathrm{SO}(n)$ -principal bundles is discussed in [MuSi03] in terms of the corresponding bundle gerbe, via. observation 1.2.73.

Example 1.2.140 (Bockstein homomorphism). The exact sequence

$$\mathbb{Z} \xrightarrow{2} \mathbb{Z} \rightarrow \mathbb{Z}_2$$

induces, by example 1.2.137, for each $n \in \mathbb{N}$ a characteristic class

$$\beta_2 : \mathbf{B}^n\mathbb{Z}_2 \rightarrow \mathbf{B}^{n+1}\mathbb{Z} .$$

This is the *Bockstein homomorphism*.

Example 1.2.141 (third integral Stiefel-Whitney class). The composite of the second Stiefel-Whitney class from example 1.2.139 with the Bockstein homomorphism from example 1.2.140 is the *third integral Stiefel-Whitney class*

$$W_3 : \mathbf{BSO} \xrightarrow{\mathbf{w}_2} \mathbf{B}^2\mathbb{Z}_2 \xrightarrow{\beta_2} \mathbf{B}^3\mathbb{Z} .$$

This has a refined factorization through the universal Dixmier-Douady class from example 1.2.136:

$$\mathbf{W}_3 : \mathbf{BSO} \rightarrow \mathbf{B}^2U(1) .$$

This is discussed in lemma 5.2.71 below.

Example 1.2.142 (first Pontryagin class). Let G be a compact and simply connected simple Lie group. Then the resolution from example 1.2.99 naturally supports a characteristic class presented by the 3-anafunctor

$$\begin{array}{c} \mathbf{B}(U(1) \rightarrow \hat{\Omega}G \rightarrow PG) \longrightarrow \mathbf{B}(U(1) \rightarrow 1 \rightarrow 1) \equiv \mathbf{B}^3U(1) . \\ \downarrow \simeq \\ \mathbf{B}G \end{array}$$

For $G = \text{Spin}$ the spin group, this presents one half of the universal *first Pontryagin class*. This we discuss in detail in 5.1.

Composition with this class sends G -principal bundles to circle 2-bundles, 1.2.72, hence by 1.2.93 to bundle 2-gerbes. Our discussion in 5.1 shows that these are the *Chern-Simons 2-gerbes*.

The canonical action functional, 1.2.6.1.5, induced by $\frac{1}{2}\mathbf{p}_1$ over a compact 3-dimensional Σ

$$\exp(iS_{\frac{1}{2}\mathbf{p}_1}) : \mathbf{H}(\Sigma, \mathbf{B}\text{Spin}_{\text{conn}}) \xrightarrow{\mathbf{H}(\Sigma, \frac{1}{2}\hat{\mathbf{p}}_1)} \mathbf{H}(\Sigma, \mathbf{B}^3U(1)_{\text{conn}}) \xrightarrow{f_\Sigma} U(1)$$

is the action functional of ordinary 3-dimensional Chern-Simons theory, refined to the moduli stack of field configurations. This we discuss in 5.5.5.1.

1.2.8 Lie algebras

A Lie algebra is, in a precise sense, the infinitesimal approximation to a Lie group. This statement generalizes to *smooth n -groups* (the strict case of which we had seen in definition 1.2.89); their infinitesimal approximation are *Lie n -algebras* which for arbitrary n are known as *L_∞ -algebras*. The statement also generalizes to *Lie groupoids* (discussed in 1.2.5); their infinitesimal approximation are *Lie algebroids*. Both these are special cases of a joint generalization; where smooth n -groupoids have *L_∞ -algebroids* as their infinitesimal approximation.

The following is an exposition of basic L_∞ -algebraic structures, their relation to smooth n -groupoids and the notion of connection data with coefficients in L_∞ -algebras.

The following discussion proceeds by these topics:

- L_∞ -algebroids;
- Lie integration;
- Characteristic cocycles from Lie integration;
- L_∞ -algebra valued connections;
- Curvature characteristics and Chern-Simons forms;
- ∞ -Connections from Lie integration;

1.2.8.1 L_∞ -algebroids There is a precise sense in which one may think of a Lie algebra \mathfrak{g} as the infinitesimal sub-object of the delooping groupoid $\mathbf{B}G$ of the corresponding Lie group G . Without here going into the details, which are discussed in detail below in 4.5.1, we want to build certain smooth ∞ -groupoids from the knowledge of their infinitesimal subobjects: these subobjects are *L_∞ -algebroids* and specifically *L_∞ -algebras*.

For \mathfrak{g} an \mathbb{N} -graded vector space, write $\mathfrak{g}[1]$ for the same underlying vector space with all degrees shifted up by one. (Often this is denoted $\mathfrak{g}[-1]$ instead). Then

$$\wedge^\bullet \mathfrak{g} = \mathrm{Sym}^\bullet(\mathfrak{g}[1])$$

is the *Grassmann algebra* on \mathfrak{g} ; the free graded-commutative algebra on $\mathfrak{g}[1]$.

Definition 1.2.143. An *L_∞ -algebra* structure on an \mathbb{N} -graded vector space \mathfrak{g} is a family of multilinear maps

$$[-, \dots, -]_k : \mathrm{Sym}^k(\mathfrak{g}[1]) \rightarrow \mathfrak{g}[1]$$

of degree -1 , for all $k \in \mathbb{N}$, such that the *higher Jacobi identities*

$$\sum_{k+l=n+1} \sum_{\sigma \in \mathrm{UnSh}(l, k-1)} (-1)^\sigma t_{a_1, \dots, t_{a_l}], t_{a_{l+1}}, \dots, t_{a_{k+l-1}}} = 0$$

are satisfied for all $n \in \mathbb{N}$ and all $\{t_{a_i} \in \mathfrak{g}\}$.

See [SSS09a] for a review and for references.

Example 1.2.144. If \mathfrak{g} is concentrated in degree 0, then an L_∞ -algebra structure on \mathfrak{g} is the same as an ordinary Lie algebra structure. The only non-trivial bracket is $[-, -]_2 : \mathfrak{g} \otimes \mathfrak{g} \rightarrow \mathfrak{g}$ and the higher Jacobi identities reduce to the ordinary Jacobi identity.

We will see many other examples of L_∞ -algebras. For identifying these, it turns out to be useful to have the following dual formulation of L_∞ -algebras.

Proposition 1.2.145. *Let \mathfrak{g} be a \mathbb{N} -graded vector space that is degreewise finite dimensional. Write \mathfrak{g}^* for the degreewise dual, also \mathbb{N} -graded.*

Then dg-algebra structures on the Grassmann algebra $\wedge^\bullet \mathfrak{g}^ = \text{Sym}^\bullet \mathfrak{g}[1]^*$ are in canonical bijection with L_∞ -algebra structures on \mathfrak{g} , def. 1.2.143.*

Here the sum is over all $(l, k-1)$ *unshuffles*, which means all permutations $\sigma \in \Sigma_{k+l-1}$ that preserves the order within the first l and within the last $k-1$ arguments, respectively, and $(-1)^{\text{sgn}}$ is the Koszul-sign of the permutation: the sign picked up by “unshuffling” $t^{a_1} \wedge \cdots \wedge t^{a_{k+l-1}}$ according to σ .

Proof. Let $\{t_a\}$ be a basis of $\mathfrak{g}[1]$. Write $\{t^a\}$ for the dual basis of $\mathfrak{g}[1]^*$, where t^a is taken to be in the same degree as t_a .

A derivation $d : \wedge^\bullet \mathfrak{g}^* \rightarrow \wedge^\bullet \mathfrak{g}^*$ of the Grassmann algebra is fixed by its value on generators, where it determines and is determined by a sequence of brackets graded-symmetric multilinear maps $\{[-, \cdots, -]\}_{k=1}^\infty$ by

$$d : t^a \mapsto - \sum_{k=1}^{\infty} \frac{1}{k!} [t_{a_1}, \cdots, t_{a_k}]^a t^{a_1} \wedge \cdots \wedge t^{a_k},$$

where a sum over repeated indices is understood. This derivation is of degree $+1$ precisely if all the k -ary maps are of degree -1 . It is straightforward to check that the condition $d \circ d = 0$ is equivalent to the higher Jacobi identities. \square

Definition 1.2.146. The dg-algebra corresponding to an L_∞ -algebra \mathfrak{g} by prop. 1.2.145 we call the *Chevalley-Eilenberg algebra* $\text{CE}(\mathfrak{g})$ of \mathfrak{g} .

Example 1.2.147. For \mathfrak{g} an ordinary Lie algebra, as in example 1.2.144, the notion of Chevalley-Eilenberg algebra from def. 1.2.146 coincides with the traditional notion.

Examples 1.2.148. • A *strict* L_∞ -algebra algebra is a dg-Lie algebra $(\mathfrak{g}, \partial, [-, -])$ with $(\mathfrak{g}^*, \partial^*)$ a cochain complex in non-negative degree. With \mathfrak{g}^* denoting the degreewise dual, the corresponding CE-algebra is $\text{CE}(\mathfrak{g}) = (\wedge^\bullet \mathfrak{g}^*, d_{\text{CE}} = [-, -]^* + \partial^*)$.

- We had already seen above the infinitesimal approximation of a Lie 2-group: this is a Lie 2-algebra. If the Lie 2-group is a smooth strict 2-group it is encoded equivalently by a crossed module of ordinary Lie groups, and the corresponding Lie 2-algebra is given by a differential crossed module of ordinary Lie algebras.
- For $n \in \mathbb{N}$, $n \geq 1$, the Lie n -algebra $b^{n-1}\mathbb{R}$ is the infinitesimal approximation to $\mathbf{B}^n U(\mathbb{R})$ and $\mathbf{B}^n \mathbb{R}$. Its CE-algebra is the dg-algebra on a single generators in degree n , with vanishing differential.
- For any ∞ -Lie algebra \mathfrak{g} there is an L_∞ -algebra $\text{inn}(\mathfrak{g})$ defined by the fact that its CE-algebra is the Weil algebra of \mathfrak{g} :

$$\text{CE}(\text{inn}(\mathfrak{g})) = \text{W}(\mathfrak{g}) = (\wedge^\bullet (\mathfrak{g}^* \oplus \mathfrak{g}^*[1]), d_{\text{W}}|_{\mathfrak{g}^*} = d_{\text{CE}} + \sigma),$$

where $\sigma : \mathfrak{g}^* \rightarrow \mathfrak{g}^*[1]$ is the grading shift isomorphism, extended as a derivation.

Example 1.2.149. For \mathfrak{g} an L_∞ -algebra, its *automorphism* L_∞ -algebra $\mathfrak{dct}(\mathfrak{g})$ is the dg-Lie algebra whose elements in degree k are the derivations

$$\iota : \text{CE}(\mathfrak{g}) \rightarrow \text{CE}(\mathfrak{g})$$

of degree $-k$, whose differential is given by the graded commutator $[d_{\text{CE}(\mathfrak{g})}, -]$ and whose Lie bracket is the commutator bracket of derivations.

In the context of rational homotopy theory, this is discussed on p. 312 of [Su77].

One advantage of describing an L_∞ -algebra in terms of its dual Chevalley-Eilenberg algebra is that in this form the correct notion of morphism is manifest.

Definition 1.2.150. A morphism of L_∞ -algebras $\mathfrak{g} \rightarrow \mathfrak{h}$ is a morphism of dg-algebras $\mathrm{CE}(\mathfrak{g}) \leftarrow \mathrm{CE}(\mathfrak{h})$.

The category $L_\infty\mathrm{Alg}$ of L_∞ -algebras is therefore the full subcategory of the opposite category of dg-algebras on those whose underlying graded algebra is free:

$$L_\infty\mathrm{Alg} \xrightarrow{\mathrm{CE}(-)} \mathrm{dgAlg}_{\mathbb{R}}^{\mathrm{op}}.$$

Replacing in this characterization the ground field \mathbb{R} by an algebra of smooth functions on a manifold \mathfrak{a}_0 , we obtain the notion of an L_∞ -algebroid \mathfrak{g} over \mathfrak{a}_0 . Morphisms $\mathfrak{a} \rightarrow \mathfrak{b}$ of such ∞ -Lie algebroids are dually precisely morphisms of dg-algebras $\mathrm{CE}(\mathfrak{a}) \leftarrow \mathrm{CE}(\mathfrak{b})$.

Definition 1.2.151. The category of L_∞ -algebroids is the opposite category of the full subcategory of dgAlg

$$\infty\mathrm{LieAlgbd} \subset \mathrm{dgAlg}^{\mathrm{op}}$$

on graded-commutative cochain dg-algebras in non-negative degree whose underlying graded algebra is an exterior algebra over its degree-0 algebra, and this degree-0 algebra is the algebra of smooth functions on a smooth manifold.

Remark 1.2.152. More precisely the above definition is that of *affine* C^∞ - L_∞ -algebroids. There are various ways to refine this to something more encompassing, but for the purposes of this introductory discussion the above is convenient and sufficient. A more comprehensive discussion is in 4.5.1 below.

Example 1.2.153. • The *tangent Lie algebroid* TX of a smooth manifold X is the infinitesimal approximation to its fundamental ∞ -groupoid. Its CE-algebra is the de Rham complex

$$\mathrm{CE}(TX) = \Omega^\bullet(X).$$

1.2.8.2 Lie integration We discuss *Lie integration*: a construction that sends an L_∞ -algebroid to a smooth ∞ -groupoid of which it is the infinitesimal approximation.

The construction we want to describe may be understood as a generalization of the following proposition. This is classical, even if maybe not reflected in the standard textbook literature to the extent it deserves to be.

Definition 1.2.154. For \mathfrak{g} a (finite-dimensional) Lie algebra, let $\mathrm{exp}(\mathfrak{g}) \in [\mathrm{CartSp}^{\mathrm{op}}, \mathrm{sSet}]$ be the simplicial presheaf given by the assignment

$$\mathrm{exp}(\mathfrak{g}) : U \mapsto \mathrm{Hom}_{\mathrm{dgAlg}}(\mathrm{CE}(\mathfrak{g}), \Omega^\bullet(U \times \Delta^\bullet)_{\mathrm{vert}}),$$

in degree k of dg-algebra homomorphisms from the Chevalley-Eilenberg algebra of \mathfrak{g} to the dg-algebra of vertical differential forms with respect to the trivial bundle $U \times \Delta^k \rightarrow U$.

Shortly we will be considering variations of such assignments that are best thought about when writing out the hom-sets on the right here as sets of arrows; as in

$$\mathrm{exp}(\mathfrak{g}) : (U, [k]) \mapsto \left\{ \Omega_{\mathrm{vert}}^\bullet(U \times \Delta^k) \xrightarrow{A_{\mathrm{vert}}} \mathrm{CE}(\mathfrak{g}) \right\}.$$

For \mathfrak{g} an ordinary Lie algebra it is an ancient and simple but important observation that dg-algebra morphisms $\Omega^\bullet(\Delta^k) \leftarrow \mathrm{CE}(\mathfrak{g})$ are in natural bijection with Lie-algebra valued 1-forms that are *flat* in that their curvature 2-forms vanish: the 1-form itself determines precisely a morphism of the underlying graded algebras, and the respect for the differentials is exactly the flatness condition. It is this elementary but similarly important observation that historically led Eli Cartan to Cartan calculus and the algebraic formulation of Chern-Weil theory.

One finds that it makes good sense to generally, for \mathfrak{g} any ∞ -Lie algebra or even ∞ -Lie algebroid, think of $\mathrm{Hom}_{\mathrm{dgAlg}}(\mathrm{CE}(\mathfrak{g}), \Omega^\bullet(\Delta^k))$ as the set of ∞ -Lie algebroid valued differential forms whose curvature forms (generally a whole tower of them) vanishes.

Proposition 1.2.155. *Let G be the simply-connected Lie group integrating \mathfrak{g} according to Lie's three theorems and $\mathbf{B}G \in [\text{CartSp}^{\text{op}}, \text{Grpd}]$ its delooping Lie groupoid regarded as a groupoid-valued presheaf on CartSp . Write $\tau_1(-)$ for the truncation operation that quotients out 2-morphisms in a simplicial presheaf to obtain a presheaf of groupoids.*

We have an isomorphism

$$\mathbf{B}G = \tau_1 \exp(\mathfrak{g}).$$

To see this, observe that the presheaf $\exp(\mathfrak{g})$ has as 1-morphisms U -parameterized families of \mathfrak{g} -valued 1-forms A_{vert} on the interval, and as 2-morphisms U -parameterized families of *flat* 1-forms on the disk, interpolating between these. By identifying these 1-forms with the pullback of the Maurer-Cartan form on G , we may equivalently think of the 1-morphisms as based smooth paths in G and 2-morphisms smooth homotopies relative endpoints between them. Since G is simply-connected this means that after dividing out 2-morphisms only the endpoints of these paths remain, which identify with the points in G .

The following proposition establishes the Lie integration of the shifted 1-dimensional abelian L_∞ -algebras $b^{n-1}\mathbb{R}$.

Proposition 1.2.156. *For $n \in \mathbb{N}$, $n \geq 1$. Write*

$$\mathbf{B}^n \mathbb{R}_{\text{ch}} := \Xi \mathbb{R}[n]$$

for the simplicial presheaf on CartSp that is the image of the sheaf of chain complexes represented by \mathbb{R} in degree n and 0 in other degrees, under the Dold-Kan correspondence $\Xi : \text{Ch}_\bullet^+ \rightarrow \text{sAb} \rightarrow \text{sSet}$.

Then there is a canonical morphism

$$\int_{\Delta^\bullet} : \exp(b^{n-1}\mathbb{R}) \xrightarrow{\cong} \mathbf{B}^n \mathbb{R}_{\text{ch}}$$

given by fiber integration of differential forms along $U \times \Delta^n \rightarrow U$ and this is an equivalence (a global equivalence in the model structure on simplicial presheaves).

The proof of this statement is discussed in 4.4.14.

This statement will make an appearance repeatedly in the following discussion. Whenever we translate a construction given in terms $\exp(-)$ into a more convenient chain complex representation.

1.2.8.3 Characteristic cocycles from Lie integration We now describe characteristic classes and curvature characteristic forms on G -bundles in terms of these simplicial presheaves. For that purpose it is useful for a moment to ignore the truncation issue – to come back to it later – and consider these simplicial presheaves untruncated.

To see characteristic classes in this picture, write $\text{CE}(b^{n-1}\mathbb{R})$ for the commutative real dg-algebra on a single generator in degree n with vanishing differential. As our notation suggests, this we may think as the Chevalley-Eilenberg algebra of a *higher Lie algebra* – the ∞ -Lie algebra $b^{n-1}\mathbb{R}$ – which is an Eilenberg-MacLane object in the homotopy theory of ∞ -Lie algebras, representing ∞ -Lie algebra cohomology in degree n with coefficients in \mathbb{R} .

Restating this in elementary terms, this just says that dg-algebra homomorphisms

$$\text{CE}(\mathfrak{g}) \leftarrow \text{CE}(b^{n-1}\mathbb{R}) : \mu$$

are in natural bijection with elements $\mu \in \text{CE}(\mathfrak{g})$ of degree n , that are closed, $d_{\text{CE}(\mathfrak{g})}\mu = 0$. This is the classical description of a cocycle in the Lie algebra cohomology of \mathfrak{g} .

Definition 1.2.157. Every such ∞ -Lie algebra cocycle μ induces a morphism of simplicial presheaves

$$\exp(\mu) : \exp(\mathfrak{g}) \rightarrow \exp(b^n \mathbb{R})$$

given by postcomposition

$$\Omega_{\text{vert}}^\bullet(U \times \Delta^l) \xleftarrow{A_{\text{vert}}} \text{CE}(\mathfrak{g}) \xleftarrow{\mu} \text{CE}(b^n \mathbb{R}).$$

Example 1.2.158. Assume \mathfrak{g} to be a semisimple Lie algebra, let $\langle -, - \rangle$ be the Killing form and $\mu = \langle -, [-, -] \rangle$ the corresponding 3-cocycle in Lie algebra cohomology. We may assume without restriction that this cocycle is normalized such that its left-invariant continuation to a 3-form on G has integral periods. Observe that since $\pi_2(G)$ is trivial we have that the 3-coskeleton (see around def. 3.6.28 for details on coskeleta) of $\exp(\mathfrak{g})$ is equivalent to $\mathbf{B}G$. By the integrality of μ , the operation of $\exp(\mu)$ on $\exp(\mathfrak{g})$ followed by integration over simplices descends to an ∞ -anafunctor from $\mathbf{B}G$ to $\mathbf{B}^3U(1)$, as indicated on the right of this diagram in $[\text{CartSp}^{\text{op}}, \text{sSet}]$

$$\begin{array}{ccccc}
 & & \exp(\mathfrak{g}) & \xrightarrow{\exp(\mu)} & \exp(b^{n-1}\mathbb{R}) \\
 & & \downarrow & & \downarrow f_{\Delta^\bullet} \\
 C(V) & \xrightarrow{\hat{g}} & \text{cosk}_3 \exp(\mathfrak{g}) & \xrightarrow{\int_{\Delta^\bullet} \text{cosk}_3 \exp(\mu)} & \mathbf{B}^3\mathbb{R}/\mathbb{Z} \\
 \downarrow \simeq & & \downarrow \simeq & & \\
 C(U) & \xrightarrow{g} & \mathbf{B}G & & \\
 \downarrow \simeq & & & & \\
 X & & & &
 \end{array}$$

Precomposing this – as indicated on the left of the diagram – with another ∞ -anafunctor $X \xrightarrow{\simeq} C(U) \xrightarrow{g} \mathbf{B}G$ for a G -principal bundle, hence a collection of transition functions $\{g_{ij} : U_i \cap U_j \rightarrow G\}$ amounts to choosing (possibly on a refinement V of the cover U of X)

- on each $V_i \cap V_j$ a lift \hat{g}_{ij} of g_{ij} to a family of smooth based paths in G – $\hat{g}_{ij} : (V_i \cap V_j) \times \Delta^1 \rightarrow G$ – with endpoints g_{ij} ;
- on each $V_i \cap V_j \cap V_k$ a smooth family $\hat{g}_{ijk} : (V_i \cap V_j \cap V_k) \times \Delta^2 \rightarrow G$ of disks interpolating between these paths;
- on each $V_i \cap V_j \cap V_k \cap V_l$ a smooth family $\hat{g}_{ijkl} : (V_i \cap V_j \cap V_k \cap V_l) \times \Delta^3 \rightarrow G$ of 3-balls interpolating between these disks.

On this data the morphism $\int_{\Delta^\bullet} \exp(\mu)$ acts by sending each 3-cell to the number

$$\hat{g}_{ijkl} \mapsto \int_{\Delta^3} \hat{g}_{ijkl}^* \mu \pmod{\mathbb{Z}},$$

where μ is regarded in this formula as a closed 3-form on G .

We say this is *Lie integration of Lie algebra cocycles*.

Proposition 1.2.159. *For $G = \text{Spin}$, the Čech cohomology cocycle obtained this way is the first fractional Pontryagin class of the G -bundle classified by G .*

We shall show this below, as part of our L_∞ -algebraic reconstruction of the above motivating example. In order to do so, we now add differential refinement to this Lie integration of characteristic classes.

1.2.8.4 L_∞ -algebra valued connections In 1.2.5 we described ordinary connections on bundles as well as connections on 2-bundles in terms of parallel transport over paths and surfaces, and showed how such is equivalently given by cocycles with coefficients in Lie-algebra valued differential forms and Lie 2-algebra valued differential forms, respectively.

Notably we saw for the case of ordinary $U(1)$ -principal bundles, that the connection and curvature data on these is encoded in presheaves of diagrams that over a given test space $U \in \text{CartSp}$ look like

$$\begin{array}{ccc}
 U & \longrightarrow & \mathbf{B}U(1) & \text{transition function} \\
 \downarrow & & \downarrow & \\
 \mathbf{\Pi}(U) & \longrightarrow & \mathbf{B}\text{INN}(U) & \text{connection} \\
 \downarrow & & \downarrow & \\
 \mathbf{\Pi}(U) & \longrightarrow & \mathbf{B}^2U(1) & \text{curvature}
 \end{array}$$

together with a constraint on the bottom morphism.

It is in the form of such a kind of diagram that the general notion of connections on ∞ -bundles may be modeled. In the full theory in 3 this follows from first principles, but for our present introductory purpose we shall be content with taking this simple situation of $U(1)$ -bundles together with the notion of Lie integration as sufficient motivation for the constructions considered now.

So we pass now to what is to some extent the reverse construction of the one considered before: we define a notion of L_∞ -algebra valued differential forms and show how by a variant of Lie integration these integrate to coefficient objects for connections on ∞ -bundles.

1.2.8.5 Curvature characteristics and Chern-Simons forms For G a Lie group, we have described above connections on G -principal bundles in terms of cocycles with coefficients in the Lie-groupoid of Lie-algebra valued forms $\mathbf{B}G_{\text{conn}}$

$$\begin{array}{ccc}
 & & \mathbf{B}G_{\text{conn}} & \text{connection} \\
 & \nearrow \nabla & \downarrow & \\
 & & \mathbf{B}G_{\text{diff}} & \text{pseudo-connection} \\
 & \nearrow \nabla_{\text{ps}} & \downarrow \simeq & \\
 C(U)\mathfrak{g} & \longrightarrow & \mathbf{B}G & \text{transition function} \\
 \downarrow \simeq & & & \\
 X & & &
 \end{array}$$

In this context we had *derived* Lie-algebra valued forms from the parallel transport description $\mathbf{B}G_{\text{conn}} = [\mathbf{P}_1(-), \mathbf{B}G]$. We now turn this around and use Lie integration to construct parallel transport from Lie-algebra valued forms. The construction is such that it generalizes verbatim to ∞ -Lie algebra valued forms. For that purpose notice that another classical dg-algebra associated with \mathfrak{g} is its *Weil algebra* $W(\mathfrak{g})$.

Proposition 1.2.160. *The Weil algebra $W(\mathfrak{g})$ is the free dg-algebra on the graded vector space \mathfrak{g}^* , meaning that there is a natural bijection*

$$\text{Hom}_{\text{dgAlg}}(W(\mathfrak{g}), A) \simeq \text{Hom}_{\text{Vect}_\mathbb{Z}}(\mathfrak{g}^*, A),$$

which is singled out among the isomorphism class of dg-algebras with this property by the fact that the projection of graded vector spaces $\mathfrak{g}^ \oplus \mathfrak{g}^*[1] \rightarrow \mathfrak{g}^*$ extends to a dg-algebra homomorphism*

$$\text{CE}(\mathfrak{g}) \leftarrow W(\mathfrak{g}) : i^* .$$

(Notice that general the dg-algebras that we are dealing with are *semi-free* dg-algebras in that only their underlying graded algebra is free, but not the differential).

The most obvious realization of the free dg-algebra on \mathfrak{g}^* is $\wedge^\bullet(\mathfrak{g}^* \oplus \mathfrak{g}^*[1])$ equipped with the differential that is precisely the degree shift isomorphism $\sigma : \mathfrak{g}^* \rightarrow \mathfrak{g}^*[1]$ extended as a derivation. This is not the Weil algebra on the nose, but is of course isomorphic to it. The differential of the Weil algebra on $\wedge^\bullet(\mathfrak{g}^* \oplus \mathfrak{g}^*[1])$ is given on the unshifted generators by the sum of the CE-differential with the shift isomorphism

$$d_{W(\mathfrak{g})}|_{\mathfrak{g}^*} = d_{\text{CE}(\mathfrak{g})} + \sigma.$$

This uniquely fixes the differential on the shifted generators – a phenomenon known (at least after mapping this to differential forms, as we discuss below) as the *Bianchi identity*.

Using this, we can express also the presheaf $\mathbf{BG}_{\text{diff}}$ from above in diagrammatic fashion

Observation 1.2.161. For G a simply connected Lie group, the presheaf $\mathbf{BG}_{\text{diff}} \in [\text{CartSp}^{\text{op}}, \text{Grpd}]$ is isomorphic to

$$\mathbf{BG}_{\text{diff}} = \tau_1 \left(\exp(\mathfrak{g})_{\text{diff}} : (U, [k]) \mapsto \left\{ \begin{array}{ccc} \Omega_{\text{vert}}^\bullet(U \times \Delta^k) A_{\text{vert}} & \longleftarrow & \text{CE}(\mathfrak{g}) \\ \uparrow & & \uparrow \\ \Omega^\bullet(U \times \Delta^k) A & \longleftrightarrow & W(\mathfrak{g}) \end{array} \right\} \right)$$

where on the right we have the 1-truncation of the simplicial presheaf of diagrams as indicated, where the vertical morphisms are the canonical ones.

Here over a given U the bottom morphism in such a diagram is an arbitrary \mathfrak{g} -valued 1-form A on $U \times \Delta^k$. This we can decompose as $A = A_U + A_{\text{vert}}$, where A_U vanishes on tangents to Δ^k and A_{vert} on tangents to U . The commutativity of the diagram asserts that A_{vert} has to be such that the curvature 2-form $F_{A_{\text{vert}}}$ vanishes when both its arguments are tangent to Δ^k .

On the other hand, there is in the above no further constraint on A_U . Accordingly, as we pass to the 1-truncation of $\exp(\mathfrak{g})_{\text{diff}}$ we find that morphisms are of the form $(A_U)_1 \xrightarrow{g} (A_U)_2$ with $(A_U)^i$ arbitrary. This is the definition of $\mathbf{BG}_{\text{diff}}$.

We see below that it is not a coincidence that this is reminiscent to the first condition on an Ehresmann connection on a G -principal bundle, which asserts that restricted to the fibers a connection 1-form on the total space of the bundle has to be flat. Indeed, the simplicial presheaf $\mathbf{BG}_{\text{diff}}$ may be thought of as the ∞ -sheaf of pseudo-connections on *trivial* ∞ -bundles. Imposing on this also the second Ehresmann condition will force the pseudo-connection to be a genuine connection.

We now want to lift the above construction $\exp(\mu)$ of characteristic classes by Lie integration of Lie algebra cocycles μ from plain bundles classified by \mathbf{BG} to bundles with (pseudo-)connection classified by $\mathbf{BG}_{\text{diff}}$. By what we just said we therefore need to extend $\exp(\mu)$ from a map on just $\exp(\mathfrak{g})$ to a map on $\exp(\mathfrak{g})_{\text{diff}}$. This is evidently achieved by completing a square in dgAlg of the form

$$\begin{array}{ccc} \text{CE}(\mathfrak{g})\mu & \longleftarrow & \text{CE}(b^{n-1}\mathbb{R}) \\ \uparrow & & \uparrow \\ W(\mathfrak{g}) & \xleftarrow{cs} & W(b^{n-1}\mathbb{R}) \end{array}$$

and defining $\exp(\mu)_{\text{diff}} : \exp(\mathfrak{g})_{\text{diff}} \rightarrow \exp(b^{n-1}\mathbb{R})_{\text{diff}}$ to be the operation of forming pasting composites with this.

Here $W(b^{n-1}\mathbb{R})$ is the Weil algebra of the Lie n -algebra $b^{n-1}\mathbb{R}$. This is the dg-algebra on two generators c and k , respectively, in degree n and $(n+1)$ with the differential given by $d_{W(b^{n-1}\mathbb{R})} : c \mapsto k$. The commutativity of this diagram says that the bottom morphism takes the degree- n generator c to an element $cs \in W(\mathfrak{g})$ whose restriction to the unshifted generators is the given cocycle μ .

As we shall see below, any such choice cs will extend the characteristic cocycle obtained from $\exp(\mu)$ to a characteristic differential cocycle, exhibiting the ∞ -Chern-Weil homomorphism. But only for special

nice choices of cs will take genuine ∞ -connections to genuine ∞ -connections – instead of to pseudo-connections. As we discuss in the full ∞ -Chern-Weil theory, this makes no difference in cohomology. But in practice it is useful to fine-tune the construction such as to produce nice models of the ∞ -Chern-Weil homomorphism given by genuine ∞ -connections. This is achieved by imposing the following additional constraint on the choice of extension cs of μ :

Definition 1.2.162. For $\mu \in CE(\mathfrak{g})$ a cocycle and $cs \in W(\mathfrak{g})$ a lift of μ through $W(\mathfrak{g}) \leftarrow CE(\mathfrak{g})$, we say that $d_{W(\mathfrak{g})}$ is an invariant polynomial *in transgression* with μ if $d_{W(\mathfrak{g})}$ sits entirely in the shifted generators, in that $d_{W(\mathfrak{g})} \in \wedge^\bullet \mathfrak{g}^*[1] \hookrightarrow W(\mathfrak{g})$.

Definition 1.2.163. Write $inv(\mathfrak{g}) \subset W(\mathfrak{g})$ (or $W(\mathfrak{g})_{\text{basic}}$) for the sub-dg-algebra on invariant polynomials.

Observation 1.2.164. We have $W(b^{n-1}\mathbb{R}) \simeq CE(b^n\mathbb{R})$.

Using this, we can now encode the two conditions on the extension cs of the cocycle μ as the commutativity of this double square diagram

$$\begin{array}{ccc}
 CE(\mathfrak{g}) & \xleftarrow{\mu} & CE(b^{n-1}\mathbb{R}) & \text{cocycle} \\
 \uparrow & & \uparrow & \\
 W(\mathfrak{g}) & \xleftarrow{cs} & W(b^{n-1}\mathbb{R}) & \text{Chern-Simons element} \\
 \uparrow & & \uparrow & \\
 inv(\mathfrak{g}) & \xrightarrow{\langle - \rangle} & inv(b^{n-1}\mathbb{R}) & \text{invariant polynomial}
 \end{array}$$

Definition 1.2.165. In such a diagram, we call cs the *Chern-Simons element* that exhibits the transgression between μ and $\langle - \rangle$.

We shall see below that under the ∞ -Chern-Weil homomorphism, Chern-Simons elements give rise to the familiar Chern-Simons forms – as well as their generalizations – as local connection data of secondary characteristic classes realized as circle nn -bundles with connection.

Observation 1.2.166. What this diagram encodes is the construction of the connecting homomorphism for the long exact sequence in cohomology that is induced from the short exact sequence

$$\ker(i^*) \rightarrow W(\mathfrak{g}) \rightarrow CE(\mathfrak{g})$$

subject to the extra constraint of basic elements.

$$\begin{array}{ccc}
 \langle - \rangle & \xleftarrow{\quad} & \langle - \rangle \\
 \uparrow d_W & & \\
 \mu & \xleftarrow{\quad} & cs
 \end{array}$$

$$CE(\mathfrak{g}) \xleftarrow{i^*} W(\mathfrak{g}) \xleftarrow{\quad} inv(\mathfrak{g})$$

To appreciate the construction so far, recall the following classical fact

Fact 1.2.167. For G a compact Lie group, the rationalization $BG \otimes k$ of the classifying space BG is the rational space whose Sullivan model is given by the algebra $inv(\mathfrak{g})$ of invariant polynomials on the Lie algebra \mathfrak{g} .

So we have obtained the following picture:

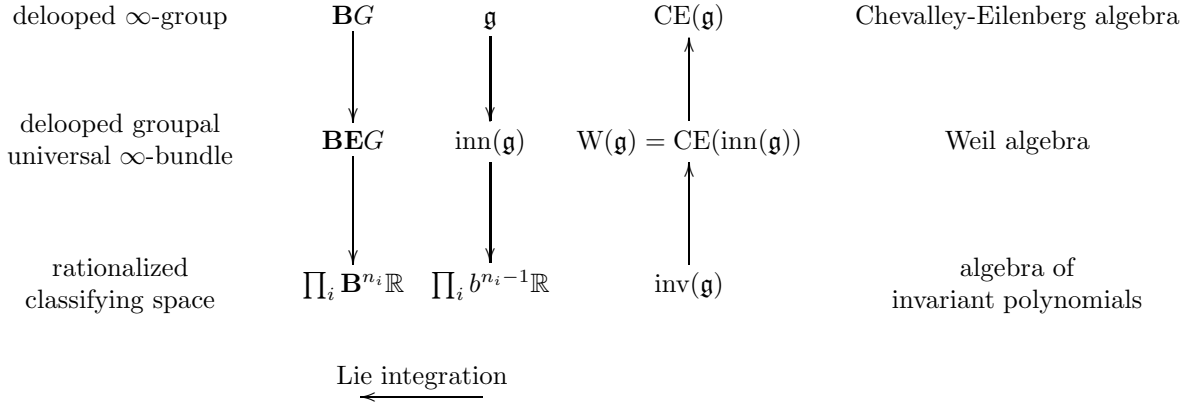

Example 1.2.168. For \mathfrak{g} a semisimple Lie algebra, $\langle -, - \rangle$ the Killing form invariant polynomial, there is a Chern-Simons element $\text{cs} \in \mathbf{W}(\mathfrak{g})$ witnessing the transgression to the cocycle $\mu = -\frac{1}{6}\langle -, [-, -] \rangle$. Under a \mathfrak{g} -valued form $\Omega^\bullet(X) \leftarrow \mathbf{W}(\mathfrak{g}) : A$ this maps to the ordinary degree 3 Chern-Simons form

$$\text{cs}(A) = \langle A \wedge dA \rangle + \frac{1}{3} \langle A \wedge [A \wedge A] \rangle.$$

1.2.8.6 ∞ -Connections from Lie integration For \mathfrak{g} an L_∞ -algebroid we have seen above the object $\exp(\mathfrak{g})_{\text{diff}}$ that represents pseudo-connections on $\exp(\mathfrak{g})$ -principal ∞ -bundles and serves to support the ∞ -Chern-Weil homomorphism. We now discuss the genuine ∞ -connections among these pseudo-connections. A derivation from first principles of the following construction is given below in 4.4.17.

The construction is due to [SSS09c] and [FSS10].

Definition 1.2.169. Let X be a smooth manifold and \mathfrak{g} an L_∞ -algebra algebra or more generally an L_∞ -algebroid.

An L_∞ -algebroid valued differential form on X is a morphism of dg-algebras

$$\Omega^\bullet(X) \leftarrow \mathbf{W}(\mathfrak{g}) : A$$

from the Weil algebra of \mathfrak{g} to the de Rham complex of X . Dually this is a morphism of L_∞ -algebroids

$$A : TX \rightarrow \text{inn}(\mathfrak{g})$$

from the inner automorphism ∞ -Lie algebra.

Its *curvature* is the composite of morphisms of graded vector spaces

$$\Omega^\bullet(X) \xleftarrow{A} \mathbf{W}(\mathfrak{g}) \xleftarrow{F(-)} \mathfrak{g}^*[1] : F_A.$$

Precisely if the curvatures vanish does the morphism factor through the Chevalley-Eilenberg algebra

$$(F_A = 0) \Leftrightarrow \left(\begin{array}{ccc} & & \mathbf{CE}(\mathfrak{g}) \\ & \swarrow \exists A_{\text{flat}} & \uparrow \\ \Omega^\bullet(X) & \xleftarrow{A} & \mathbf{W}(\mathfrak{g}) \end{array} \right)$$

in which case we call A *flat*.

Remark 1.2.170. For $\{x^a\}$ a coordinate chart of an L_∞ -algebroid \mathfrak{a} and

$$A^a := A(x^a) \in \Omega^{\deg(x^a)}(X)$$

the differential form assigned to the generator x^a by the \mathfrak{a} -valued form A , we have the curvature components

$$F_A^a = A(\mathbf{d}x^a) \in \Omega^{\deg(x^a)+1}(X).$$

Since $d_W = d_{CE} + \mathbf{d}$, this can be equivalently written as

$$F_A^a = A(d_W x^a - d_{CE} x^a),$$

so the *curvature* of A precisely measures the “lack of flatness” of A . Also notice that, since A is required to be a dg-algebra homomorphism, we have

$$A(d_{W(\mathfrak{a})} x^a) = d_{dR} A^a,$$

so that

$$A(d_{CE(\mathfrak{a})} x^a) = d_{dR} A^a - F_A^a.$$

Assume now A is a degree 1 \mathfrak{a} -valued differential form on the smooth manifold X , and that cs is a Chern-Simons element transgressing an invariant polynomial $\langle - \rangle$ of \mathfrak{a} to some cocycle μ , by def. 1.2.162. We can then consider the image $A(cs)$ of the Chern-Simons element cs in $\Omega^\bullet(X)$. Equivalently, we can look at cs as a map from degree 1 \mathfrak{a} -valued differential forms on X to ordinary (real valued) differential forms on X .

Definition 1.2.171. In the notations above, we write

$$\Omega^\bullet(X) \xleftarrow{A} W(\mathfrak{a}) \xleftarrow{cs} W(b^{n+1}\mathbb{R}) : cs(A)$$

for the differential form associated by the Chern-Simons element cs to the degree 1 \mathfrak{a} -valued differential form A , and call this the *Chern-Simons differential form* associated with A .

Similarly, for $\langle - \rangle$ an invariant polynomial on \mathfrak{a} , we write $\langle F_A \rangle$ for the evaluation

$$\Omega_{\text{closed}}^\bullet(X) \xleftarrow{A} W(\mathfrak{a}) \xleftarrow{\langle - \rangle} \text{inv}(b^{n+1}\mathbb{R}) : \langle F_A \rangle.$$

We call this the *curvature characteristic forms* of A .

Definition 1.2.172. For U a smooth manifold, the ∞ -groupoid of \mathfrak{g} -valued forms is the Kan complex

$$\exp(\mathfrak{g})_{\text{conn}}(U) : [k] \mapsto \left\{ \Omega^\bullet(U \times \Delta^k) \xleftarrow{A} W(\mathfrak{g}) \mid \forall v \in \Gamma(T\Delta^k) : \iota_v F_A = 0 \right\}$$

whose k -morphisms are \mathfrak{g} -valued forms A on $U \times \Delta^k$ with sitting instants, and with the property that their curvature vanishes on vertical vectors.

The canonical morphism

$$\exp(\mathfrak{g})_{\text{conn}} \rightarrow \exp(\mathfrak{g})$$

to the untruncated Lie integration of \mathfrak{g} is given by restriction of A to vertical differential forms (see below).

Here we are thinking of $U \times \Delta^k \rightarrow U$ as a trivial bundle.

The *first* Ehresmann condition can be identified with the conditions on lifts ∇ in ∞ -anafunctors

$$\begin{array}{ccc} & \exp(\mathfrak{g})_{\text{conn}} & \\ & \nearrow \nabla & \downarrow \\ C(U) & \xrightarrow{g} & \exp(\mathfrak{g}) \\ \downarrow \simeq & & \\ X & & \end{array}$$

that define connections on ∞ -bundles.

1.2.8.6.1 Curvature characteristics

Proposition 1.2.173. For $A \in \exp(\mathfrak{g})_{\text{conn}}(U, [k])$ a \mathfrak{g} -valued form on $U \times \Delta^k$ and for $\langle - \rangle \in W(\mathfrak{g})$ any invariant polynomial, the corresponding curvature characteristic form $\langle F_A \rangle \in \Omega^\bullet(U \times \Delta^k)$ descends down to U .

To see this, it is sufficient to show that for all $v \in \Gamma(T\Delta^k)$ we have

1. $\iota_v \langle F_A \rangle = 0$;
2. $\mathcal{L}_v \langle F_A \rangle = 0$.

The first condition is evidently satisfied if already $\iota_v F_A = 0$. The second condition follows with Cartan calculus and using that $d_{\text{dR}} \langle F_A \rangle = 0$:

$$\mathcal{L}_v \langle F_A \rangle = d\iota_v \langle F_A \rangle + \iota_v d \langle F_A \rangle = 0.$$

Notice that for a general ∞ -Lie algebra \mathfrak{g} the curvature forms F_A themselves are not generally closed (rather they satisfy the more Bianchi identity), hence requiring them to have no component along the simplex does not imply that they descend. This is different for abelian ∞ -Lie algebras: for them the curvature forms themselves are already closed, and hence are themselves already curvature characteristics that do descent.

It is useful to organize the \mathfrak{g} -valued form A , together with its restriction A_{vert} to vertical differential forms and with its curvature characteristic forms in the commuting diagram

$$\begin{array}{ccc}
 \Omega^\bullet(U \times \Delta^k)_{\text{vert}} & \xleftarrow{A_{\text{vert}}} & \text{CE}(\mathfrak{g}) & \text{gauge transformation} \\
 \uparrow & & \uparrow & \\
 \Omega^\bullet(U \times \Delta^k) & \xleftarrow{A} & W(\mathfrak{g}) & \mathfrak{g}\text{-valued form} \\
 \uparrow & & \uparrow & \\
 \Omega^\bullet(U) & \xleftarrow{\langle F_A \rangle} & \text{inv}(\mathfrak{g}) & \text{curvature characteristic forms}
 \end{array}$$

in dgAlg . The commutativity of this diagram is implied by $\iota_v F_A = 0$.

Definition 1.2.174. Write $\exp(\mathfrak{g})_{\text{CW}}(U)$ for the ∞ -groupoid of \mathfrak{g} -valued forms fitting into such diagrams.

$$\exp(\mathfrak{g})_{\text{CW}}(U) : [k] \mapsto \left\{ \begin{array}{ccc}
 \Omega^\bullet(U \times \Delta^k)_{\text{vert}} & \xleftarrow{A_{\text{vert}}} & \text{CE}(\mathfrak{g}) \\
 \uparrow & & \uparrow \\
 \Omega^\bullet(U \times \Delta^k) & \xleftarrow{A} & W(\mathfrak{g}) \\
 \uparrow & & \uparrow \\
 \Omega^\bullet(U) & \xleftarrow{\langle F_A \rangle} & \text{inv}(\mathfrak{g})
 \end{array} \right\}.$$

We call this the coefficient for \mathfrak{g} -valued ∞ -connections

1.2.8.6.2 1-Morphisms: integration of infinitesimal gauge transformations The 1-morphisms in $\exp(\mathfrak{g})(U)$ may be thought of as *gauge transformations* between \mathfrak{g} -valued forms. We unwind what these look like concretely.

Definition 1.2.175. Given a 1-morphism in $\exp(\mathfrak{g})(X)$, represented by \mathfrak{g} -valued forms

$$\Omega^\bullet(U \times \Delta^1) \leftarrow W(\mathfrak{g}) : A$$

consider the unique decomposition

$$A = A_U + (A_{\text{vert}} := \lambda \wedge dt) \quad ,$$

with A_U the horizontal differential form component and $t : \Delta^1 = [0, 1] \rightarrow \mathbb{R}$ the canonical coordinate.

We call λ the *gauge parameter*. This is a function on Δ^1 with values in 0-forms on U for \mathfrak{g} an ordinary Lie algebra, plus 1-forms on U for \mathfrak{g} a Lie 2-algebra, plus 2-forms for a Lie 3-algebra, and so forth.

We describe now how this encodes a gauge transformation

$$A_0(s = 0) \xrightarrow{\lambda} A_U(s = 1).$$

Observation 1.2.176. By the nature of the Weil algebra we have

$$\frac{d}{ds} A_U = d_U \lambda + [\lambda \wedge A] + [\lambda \wedge A \wedge A] + \cdots + \iota_s F_A,$$

where the sum is over all higher brackets of the ∞ -Lie algebra \mathfrak{g} .

In the Cartan calculus for the case that \mathfrak{g} an ordinary one writes the corresponding *second Ehresmann condition* $\iota_{\partial_s} F_A = 0$ equivalently

$$\mathcal{L}_{\partial_s} A = \text{ad}_\lambda A.$$

Definition 1.2.177. Define the *covariant derivative of the gauge parameter* to be

$$\nabla \lambda := d\lambda + [A \wedge \lambda] + [A \wedge A \wedge \lambda] + \cdots.$$

Remark 1.2.178. In this notation we have

- the general identity

$$\frac{d}{ds} A_U = \nabla \lambda + (F_A)_s$$

- the *horizontality constraint* or *second Ehresmann condition* $\iota_{\partial_s} F_A = 0$, the differential equation

$$\frac{d}{ds} A_U = \nabla \lambda.$$

This is known as the equation for *infinitesimal gauge transformations* of an ∞ -Lie algebra valued form.

Observation 1.2.179. By Lie integration we have that A_{vert} – and hence λ – defines an element $\exp(\lambda)$ in the ∞ -Lie group that integrates \mathfrak{g} .

The unique solution $A_U(s = 1)$ of the above differential equation at $s = 1$ for the initial values $A_U(s = 0)$ we may think of as the result of acting on $A_U(0)$ with the gauge transformation $\exp(\lambda)$.

1.2.8.7 Examples of ∞ -connections We discuss some examples of ∞ -groupoids of ∞ -connections obtained by Lie integration, as discussed in 1.2.8.6 above.

- 1.2.8.7.1 – Connections on ordinary principal bundles
- 1.2.8.7.2 – **string-2-connections**

1.2.8.7.1 Connections on ordinary principal bundles Let \mathfrak{g} be an ordinary Lie algebra and write G for the simply connected Lie group integrating it. Write $\mathbf{B}G_{\text{conn}}$ the groupoid of Lie algebra-valued forms from prop. 1.2.107.

Proposition 1.2.180. *The 1-truncation of the object $\exp(\mathfrak{g})_{\text{conn}}$ from def. 1.2.172 is equivalent to the coefficient object for G -principal connections from prop. 1.2.107. We have an equivalence*

$$\tau_1 \exp(\mathfrak{g})_{\text{conn}} = \mathbf{B}G_{\text{conn}}$$

Proof. To see this, first note that the sheaves of objects on both sides are manifestly isomorphic, both are the sheaf of $\Omega^1(-, \mathfrak{g})$. For morphisms, observe that for a form $\Omega^\bullet(U \times \Delta^1) \leftarrow W(\mathfrak{g}) : A$ which we may decompose into a horizontal and a vertical piece as $A = A_U + \lambda \wedge dt$ the condition $\iota_{\partial_t} F_A = 0$ is equivalent to the differential equation

$$\frac{\partial}{\partial t} A = d_U \lambda + [\lambda, A].$$

For any initial value $A(0)$ this has the unique solution

$$A(t) = g(t)^{-1}(A + d_U)g(t),$$

where $g : [0, 1] \rightarrow G$ is the parallel transport of λ :

$$\begin{aligned} & \frac{\partial}{\partial t} (g(t)^{-1}(A + d_U)g(t)) \\ &= g(t)^{-1}(A + d_U)\lambda g(t) - g(t)^{-1}\lambda(A + d_U)g(t) \end{aligned}$$

(where for ease of notation we write actions as if G were a matrix Lie group).

In particular this implies that the endpoints of the path of \mathfrak{g} -valued 1-forms are related by the usual cocycle condition in $\mathbf{B}G_{\text{conn}}$

$$A(1) = g(1)^{-1}(A + d_U)g(1).$$

In the same fashion one sees that given 2-cell in $\exp(\mathfrak{g})(U)$ and any 1-form on U at one vertex, there is a unique lift to a 2-cell in $\exp(\mathfrak{g})_{\text{conn}}$, obtained by parallel transporting the form around. The claim then follows from the previous statement of Lie integration that $\tau_1 \exp(\mathfrak{g}) = \mathbf{B}G$. \square

1.2.8.7.2 string-2-connections We discuss the **string** Lie 2-algebra and local differential form data for **string-2-connections**. A detailed discussion of the corresponding String-principal 2-bundles is below in 5.1.4, more discussion of the 2-connections and their twisted generalization is in 5.2.7.3.

Let \mathfrak{g} be a semisimple Lie algebra. Write $\langle -, - \rangle : \mathfrak{g}^{\otimes 2} \rightarrow \mathbb{R}$ for its Killing form and

$$\mu = \langle -, [-, -] \rangle : \mathfrak{g}^{\otimes 3} \rightarrow \mathbb{R}$$

for the canonical 3-cocycle.

We discuss two very different looking, but nevertheless equivalent Lie 2-algebras.

Definition 1.2.181 (skeletal version of **string**). Write \mathfrak{g}_μ for the Lie 2-algebra whose underlying graded vector space is

$$\mathfrak{g}_\mu = \mathfrak{g} \oplus \mathbb{R}[-1],$$

and whose nonvanishing brackets are defined as follows.

- The binary bracket is that of \mathfrak{g} when both arguments are from \mathfrak{g} and 0 otherwise.
- The trinary bracket is the 3-cocycle

$$[-, -, -]_{\mathfrak{g}_\mu} := \langle -, [-, -] \rangle : \mathfrak{g}^{\otimes 3} \rightarrow \mathbb{R}.$$

Definition 1.2.182 (strict version of **string**). Write $(\hat{\Omega}\mathfrak{g} \rightarrow P_*\mathfrak{g})$ for the Lie 2-algebra coming from the differential crossed module, def. 1.2.75, whose underlying vector space is

$$(\hat{\Omega}\mathfrak{g} \rightarrow P_*\mathfrak{g}) = P_*\mathfrak{g} \oplus (\Omega\mathfrak{g} \oplus \mathbb{R})[-1],$$

where $P_*\mathfrak{g}$ is the vector space of smooth maps $\gamma : [0, 1] \rightarrow \mathfrak{g}$ such that $\gamma(0) = 0$, and where $\Omega\mathfrak{g}$ is the subspace for which also $\gamma(1) = 0$, and whose non-vanishing brackets are defined as follows

- $[-]_1 = \partial := \Omega\mathfrak{g} \oplus \mathbb{R} \rightarrow \Omega\mathfrak{g} \hookrightarrow P_*\mathfrak{g}$;
- $[-, -] : P_*\mathfrak{g} \otimes P_*\mathfrak{g} \rightarrow P_*\mathfrak{g}$ is given by the pointwise Lie bracket on \mathfrak{g} as

$$[\gamma_1, \gamma_2] = (\sigma \mapsto [\gamma_1(\sigma), \gamma_2(\sigma)]);$$

- $[-, -] : P_*\mathfrak{g} \otimes (\Omega\mathfrak{g} \oplus \mathbb{R}) \rightarrow \Omega\mathfrak{g} \oplus \mathbb{R}$ is given by pairs

$$[\gamma, (\ell, c)] := \left([\gamma, \ell], 2 \int_0^1 \langle \gamma(\sigma), \frac{d\ell}{d\sigma}(\sigma) \rangle d\sigma \right), \quad (1.1)$$

where the first term is again pointwise the Lie bracket in \mathfrak{g} .

Proposition 1.2.183. *The linear map*

$$P_*\mathfrak{g} \oplus (\Omega\mathfrak{g} \oplus \mathbb{R})[-1] \rightarrow \mathfrak{g} \oplus \mathbb{R}[-1],$$

which in degree 0 is evaluation at the endpoint

$$\gamma \mapsto \gamma(1)$$

and which in degree 1 is projection onto the \mathbb{R} -summand, induces a weak equivalence of L_∞ algebras

$$\mathbf{string} \simeq (\hat{\Omega}\mathfrak{g} \rightarrow P_*\mathfrak{g}) \simeq \mathfrak{g}_\mu$$

Proof. This is theorem 30 in [BCSS07]. □

Definition 1.2.184. We write **string** for the *string Lie 2-algebra* if we do not mean to specify a specific presentation such as \mathfrak{so}_μ or $(\hat{\Omega}\mathfrak{so} \rightarrow P_*\mathfrak{so})$.

In more technical language we would say that **string** is defined to be the homotopy fiber of the morphism of L_∞ -algebras $\mu_3 : \mathfrak{so} \rightarrow b^2\mathbb{R}$, well defined up to weak equivalence.

Remark 1.2.185. Proposition 1.2.183 says that the two Lie 2-algebras $(\hat{\Omega}\mathfrak{g} \rightarrow P_*\mathfrak{g})$ and \mathfrak{g}_μ , which look quite different, are actually equivalent. Therefore also the local data for a String-2 connection can take two very different looking but nevertheless equivalent forms.

Let U be a smooth manifold. The data of $(\hat{\Omega}\mathfrak{g} \rightarrow P_*\mathfrak{g})$ -valued forms on X is a triple

1. $A \in \Omega^1(U, P\mathfrak{g})$;
2. $B \in \Omega^2(U, \Omega\mathfrak{g})$;
3. $\hat{B} \in \Omega^2(U, \mathbb{R})$.

consisting of a 1-form with values in the path Lie algebra of \mathfrak{g} , a 2-form with values in the loop Lie algebra of \mathfrak{g} , and an ordinary real-valued 2-form that contains the central part of $\hat{\Omega}\mathfrak{g} = \Omega\mathfrak{g} \oplus \mathbb{R}$. The curvature data of this is

1. $F = dA + \frac{1}{2}[A \wedge A] + B \in \Omega^2(U, P\mathfrak{g})$;
2. $H = d(B + \hat{B}) + [A \wedge (B + \hat{B})] \in \Omega^3(U, \Omega\mathfrak{g} \oplus \mathbb{R})$,

where in the last term we have the bracket from (1.1). Notice that if we choose a basis $\{t_a\}$ of \mathfrak{g} such that we have structure constant $[t_b, t_c] = f^a{}_{bc}t_a$, then for instance the first equation is

$$F^a(\sigma) = dA^a(\sigma) + \frac{1}{2}f^a{}_{bc}A^b(\sigma) \wedge A^c(\sigma) + B^a(\sigma).$$

On the other hand, the data of forms on U is a tuple

1. $A \in \Omega^1(U, \mathfrak{g})$;
2. $\hat{B} \in \Omega^2(U, \mathbb{R})$,

consisting of a \mathfrak{g} -valued form and a real-valued 2-form. The curvature data of this is

1. $F = dA + [A \wedge A] \in \Omega^2(\mathfrak{g})$;
2. $H = d\hat{B} + \langle A \wedge [A \wedge A] \rangle \in \Omega^3(U)$.

While these two sets of data look very different, proposition 1.2.183 implies that under their respective higher gauge transformations they are in fact equivalent.

Notice that in the first case the 2-form is valued in a nonabelian Lie algebra, whereas in the second case the 2-form is abelian, but, to compensate this, a trilinear term appears in the formula for the curvatures. By the discussion in section 1.2.8.6 this means that a \mathfrak{g}_μ -2-connection looks simpler on a single patch than an $(\hat{\Omega}\mathfrak{g} \rightarrow P_*\mathfrak{g})$ -2-connection, it has relatively more complicated behaviours on double intersections.

Moreover, notice that in the second case we see that one part of Chern-Simons term for A occurs, namely $\langle A \wedge [A \wedge A] \rangle$. The rest of the Chern-Simons term appears in this local formula after passing to yet another equivalent version of **string**, one which is well-adapted to the discussion of twisted String 2-connections. This we discuss in the next section.

The equivalence of the skeletal and the strict presentation for **string** corresponds under Lie integration to two different but equivalent models of the smooth String-2-group.

Proposition 1.2.186. *The degenerate Lie integration of $\hat{\Omega}\mathfrak{so} \rightarrow P_*\mathfrak{so}$ yields the strict Lie 2-group $(\hat{\Omega}\text{Spin} \rightarrow P_*\text{Spin})$, where $\hat{\Omega}\text{Spin}$ is the level-1 Kac-Moody central extension of the smooth loop group of Spin.*

Proof. The nontrivial part to check is that the action of $P_*\mathfrak{so}$ on $\hat{\Omega}\mathfrak{so}$ lifts to a compatible action of $P_*\text{Spin}$ on $\hat{\Omega}\text{Spin}$. This is shown in [BCSS07]. \square

Below in 5.1.4 we show that there is an equivalence of smooth n -stacks

$$\mathbf{B}(\hat{\Omega}\text{Spin} \rightarrow P_*\text{Spin}) \simeq \tau_2 \exp(\mathfrak{g}_\mu).$$

1.2.9 The Chern-Weil homomorphism

We now come to the discussion the Chern-Weil homomorphism and its generalization to the ∞ -Chern-Weil homomorphism.

We have seen in 1.2.5 G -principal ∞ -bundles for general smooth ∞ -groups G and in particular for abelian groups G . Naturally, the abelian case is easier and more powerful statements are known about this case. A general strategy for studying nonabelian ∞ -bundles therefore is to *approximate* them by abelian bundles. This is achieved by considering characteristic classes. Roughly, a characteristic class is a map that functorially sends G -principal ∞ -bundles to $\mathbf{B}^n K$ -principal ∞ -bundles, for some n and some abelian group K . In some cases such an assignment may be obtained by integration of infinitesimal data. If so, then the assignment refines to one of ∞ -bundles with connection. For G an ordinary Lie group this is then what is called the *Chern-Weil homomorphism*. For general G we call it the ∞ -*Chern-Weil homomorphism*.

The material of this section is due to [SSS09a] and [FSS10].

1.2.9.1 Motivating examples A simple motivating example for characteristic classes and the Chern-Weil homomorphism is the construction of determinant line bundles from example 1.2.135. This construction directly extends to the case where the bundles carry connections. We give an exposition of this *differential refinement* of the *universal first Chern class*, example 1.2.135. A more formal discussion of this situation is below in 5.2.7.1.

For $N \in \mathbb{N}$ We may canonically identify the Lie algebra $\mathfrak{u}(N)$ with the matrix Lie algebra of skew-hermitian matrices on which we have the trace operation

$$\mathrm{tr} : \mathfrak{u}(N) \rightarrow \mathfrak{u}(1) = i\mathbb{R}.$$

This is the differential version of the determinant in that when regarding the Lie algebra as the infinitesimal neighbourhood of the neutral element in $U(N)$ the determinant becomes the trace under the exponential map

$$\det(1 + \epsilon A) = 1 + \epsilon \mathrm{tr}(A)$$

for $\epsilon^2 = 0$. It follows that for $\mathrm{tra}_{\nabla} : \mathbf{P}_1(U_i) \rightarrow \mathbf{BU}(N)$ the parallel transport of a connection on P locally given by a 1-forms $A \in \Omega^1(U_i, \mathfrak{u}(N))$ by

$$\mathrm{tra}_{\nabla}(\gamma) = \mathcal{P} \exp \int_{[0,1]} \gamma^* A$$

the determinant parallel transport

$$\det(\mathrm{tra}_{\nabla} =: \mathbf{P}_1(U_i) \xrightarrow{\mathrm{tra}_{\nabla}} \mathbf{BU}(N) \xrightarrow{\det} \mathbf{BU}(1))$$

is locally given by the formula

$$\det(\mathrm{tra}_{\nabla}(\gamma)) = \mathcal{P} \exp \int_{[0,1]} \gamma^* \mathrm{tr} A,$$

which means that the local connection forms on the determinant line bundle are obtained from those of the unitary bundle by tracing.

$$(\det, \mathrm{tr}) : \{(g_{ij}), (A_i)\} \mapsto \{(\det g_{ij}), (\mathrm{tr} A_i)\}.$$

This construction extends to a functor

$$(\hat{\mathbf{c}}_1) := (\det, \mathrm{tr}) : U(N)\mathrm{Bund}_{\mathrm{conn}}(X) \rightarrow U(1)\mathrm{Bund}_{\mathrm{conn}}(X)$$

natural in X , that sends $U(n)$ -principal bundles with connection to circle bundles with connection, hence to cocycles in degree-2 ordinary differential cohomology.

This assignment remembers of a unitary bundle one integral class and its differential refinement:

- the integral class of the determinant bundle is the first Chern class the $U(N)$ -principal bundle

$$[\hat{c}_1(P)] = c_1(P);$$

- the curvature 2-form of its connection is a representative in de Rham cohomology of this class

$$[F_{\nabla_{\hat{c}_1(P)}}] = c_1(P)_{\text{dR}}.$$

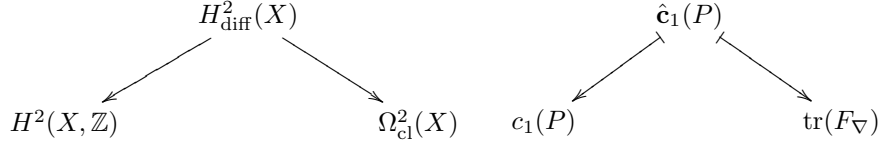

Equivalently this assignment is given by postcomposition of cocycles with a morphism of smooth ∞ -groupoids

$$\hat{c}_1 : \mathbf{BU}(N)_{\text{conn}} \rightarrow \mathbf{BU}(1)_{\text{conn}}.$$

We say that \hat{c}_1 is a *differential characteristic class*, the differential refinement of the first Chern class.

In [BrMc96b] an algorithm is given for constructing differential characteristic classes on Čech cocycles in this fashion for more general Lie algebra cocycles. For instance these authors give the following construction for the differential refinement of the first Pontryagin class [BrMc93].

Let $N \in \mathbb{N}$, write $\text{Spin}(N)$ for the Spin group and consider the canonical Lie algebra cohomology 3-cocycle

$$\mu = \langle -, [-, -] \rangle : \mathfrak{so}(N) \rightarrow \mathfrak{b}^2\mathbb{R}$$

on semisimple Lie algebras, where $\langle -, - \rangle$ is the Killing form invariant polynomial. Let $(P \rightarrow X, \nabla)$ be a $\text{Spin}(N)$ -principal bundle with connection. Let $A \in \Omega^1(P, \mathfrak{so}(N))$ be the Ehresmann connection 1-form on the total space of the bundle.

Then construct a Čech cocycle for Deligne cohomology in degree 4 as follows:

1. pick an open cover $\{U_i \rightarrow X\}$ such that there is a choice of local sections $\sigma_i : U_i \rightarrow P$. Write

$$(g_{ij}, A_i) := (\sigma_i^{-1}\sigma_j, \sigma_i^*A)$$

for the induced Čech cocycle.

2. Choose a lift of this cocycle to an assignment

- of based paths in $\text{Spin}(N)$ to double intersections

$$\hat{g}_{ij} : U_{ij} \times \Delta^1 \rightarrow \text{Spin}(N),$$

with $\hat{g}_{ij}(0) = e$ and $\hat{g}_{ij}(1) = g_{ij}$;

- of based 2-simplices between these paths to triple intersections

$$\hat{g}_{ijk} : U_{ijk} \times \Delta^2 \rightarrow \text{Spin}(N);$$

restricting to these paths in the obvious way;

- similarly of based 3-simplices between these paths to quadruple intersections

$$\hat{g}_{ijkl} : U_{ijkl} \times \Delta^3 \rightarrow \text{Spin}(N).$$

Such lifts always exists, because the Spin group is connected (because already $\text{SO}(N)$ is), simply connected (because $\text{Spin}(N)$ is the universal cover of $\text{SO}(N)$) and also has $\pi_2(\text{Spin}(N)) = 0$ (because this is the case for every compact Lie group).

3. Define from this a Deligne-cochain by setting

$$\frac{1}{2}\hat{\mathbf{P}}_1(P) := (g_{ijkl}, A_{ijk}, B_{ij}, C_i) := \begin{pmatrix} \int_{\Delta^3} (\sigma_i \cdot \hat{g}_{ijkl})^* \mu(A) \text{ mod } \mathbb{Z}, \\ \int_{\Delta^2} (\sigma_i \cdot \hat{g}_{ijk})^* \text{cs}(A), \\ \int_{\Delta^1} (\sigma_i \cdot \hat{g}_{ij})^* \text{cs}(A), \\ \sigma_i^* \mu(A) \end{pmatrix},$$

where $\text{cs}(A) = \langle A \wedge F_A \rangle + c \langle A \wedge [A \wedge A] \rangle$ is the Chern-Simons form of the connection form A with respect to the cocycle $\mu(A) = \langle A \wedge [A \wedge A] \rangle$.

They then prove:

1. This is indeed a Deligne cohomology cocycle;
2. it represents the differential refinement of the first fractional Pontryagin class of P .

$$\begin{array}{ccccc} & H^4_{\text{diff}}(X) & & \frac{1}{2}\hat{\mathbf{P}}_1(P) & \\ & \swarrow & & \swarrow & \searrow \\ H^4(X, \mathbb{Z}) & & \Omega^4_{\text{cl}}(X) & \frac{1}{2}p_1(P) & dcs(A) \end{array} .$$

In the form in which we have (re)stated this result here the second statement amounts, in view of the first statement, to the observation that the curvature 4-form of the Deligne cocycle is proportional to

$$dcs(A) \propto \langle F_A \wedge F_A \rangle \in \Omega^4_{\text{cl}}(X)$$

which represents the first Pontryagin class in de Rham cohomology. Therefore the key observation is that we have a Deligne cocycle at all. This can be checked directly, if somewhat tediously, by hand.

But then the question remains: where does this successful *Ansatz* come from? And is it *natural*? For instance: does this construction extend to a morphism of smooth ∞ -groupoids

$$\frac{1}{2}\hat{\mathbf{P}}_1 : \mathbf{BSpin}(N)_{\text{conn}} \rightarrow \mathbf{B}^3U(1)_{\text{conn}}$$

from Spin-principal bundles with connection to circle 3-bundles with connection?

In the following we give a natural presentation of the ∞ -Chern-Weil homomorphism by means of Lie integration of L_∞ -algebraic data to simplicial presheaves. Among other things, this construction yields an understanding of why this construction is what it is and does what it does.

The construction proceeds in the following broad steps

1. The infinitesimal analog of a characteristic class $\mathbf{c} : \mathbf{BG} \rightarrow \mathbf{B}^nU(1)$ is an L_∞ -algebra cocycle

$$\mu : \mathfrak{g} \rightarrow b^{n-1}\mathbb{R}.$$

2. There is a formal procedure of universal Lie integration which sends this to a morphism of smooth ∞ -groupoids

$$\exp(\mu) : \exp(\mathfrak{g}) \rightarrow \exp(b^{n-1}\mathbb{R}) \simeq \mathbf{B}^n\mathbb{R}$$

presented by a morphism of simplicial presheaves on CartSp .

3. By finding a Chern-Simons element cs that witnesses the transgression of μ to an invariant polynomial on \mathfrak{g} this construction has a differential refinement to a morphism

$$\exp(\mu, \text{cs}) : \exp(\mathfrak{g})_{\text{conn}} \rightarrow \mathbf{B}^n\mathbb{R}_{\text{conn}}$$

that sends L_∞ -algebra valued connections to line n -bundles with connection.

4. The n -truncation $\mathbf{cosk}_{n+1} \exp(\mathfrak{g})$ of the object on the left produces the smooth ∞ -groups on interest – $\mathbf{cosk}_{n+1} \exp(\mathfrak{g}) \simeq \mathbf{BG}$ – and the corresponding truncation of $\exp((\mu, cs))$ carves out the lattice Γ of periods in G of the cocycle μ inside \mathbb{R} . The result is the differential characteristic class

$$\exp(\mu, cs) : \mathbf{BG}_{\text{conn}} \rightarrow \mathbf{B}^n \mathbb{R} / \Gamma_{\text{conn}}.$$

Typically we have $\Gamma \simeq \mathbb{Z}$ such that this then reads

$$\exp(\mu, cs) : \mathbf{BG}_{\text{conn}} \rightarrow \mathbf{B}^n U(1)_{\text{conn}}.$$

1.2.9.2 The ∞ -Chern-Weil homomorphism In the full ∞ -Chern-Weil theory the ∞ -Chern-Weil homomorphism is conceptually very simple: for every n there is canonically a morphism of smooth ∞ -groupoids $\mathbf{B}^n U(1) \rightarrow \mathbf{b}_{\text{dR}} \mathbf{B}^{n+1} U(1)$ where the object on the right classifies ordinary de Rham cohomology in degree $n+1$. For G any ∞ -group and any characteristic class $\mathbf{c} : \mathbf{BG} \rightarrow \mathbf{B}^{n+1} U(1)$, the ∞ -Chern-Weil homomorphism is the operation that takes a G -principal ∞ -bundle $X \rightarrow \mathbf{BG}$ to the composite $X \rightarrow \mathbf{BG} \rightarrow \mathbf{B}^n U(1) \rightarrow \mathbf{b}_{\text{dR}} \mathbf{B}^{n+1} U(1)$.

All the constructions that we consider here in this introduction serve to *model* this abstract operation. The ∞ -connections that we considered yield resolutions of $\mathbf{B}^n U(1)$ and \mathbf{BG} in terms of which the abstract morphisms are modeled as ∞ -anafunctors.

1.2.9.2.1 ∞ -Chern-Simons functionals If we express G by Lie integration of an ∞ -Lie algebra \mathfrak{g} , then the basic ∞ -Chern-Weil homomorphism is modeled by composing an ∞ -connection $(A_{\text{vert}}, A, \langle F_A \rangle)$ with the transgression of an invariant polynomial $(\mu, cs, \langle - \rangle)$ as follows

$$\begin{aligned}
 & \left(\begin{array}{ccc} \Omega^\bullet(U \times \Delta^k) \xleftarrow{A_{\text{vert}}} \text{CE}(\mathfrak{g}) & \check{\text{Cech cocycle}} & \\ \uparrow & \uparrow & \\ \Omega^\bullet(U \times \Delta^k) \xleftarrow{A} \text{W}(\mathfrak{g}) & \text{connection} & \\ \uparrow & \uparrow & \\ \Omega^\bullet(U) \xleftarrow{\langle F_A \rangle} \text{inv}(\mathfrak{g}) & \text{curvature} & \\ & \text{characteristic forms} & \end{array} \right) \circ \left(\begin{array}{ccc} \text{CE}(\mathfrak{g}) \xleftarrow{\mu} \text{CE}(b^{n-1}\mathbb{R}) & \text{cocycle} & \\ \uparrow & \uparrow & \\ \text{W}(\mathfrak{g}) \xleftarrow{cs} \text{W}(b^{n-1}\mathbb{R}) & \text{Chern-Simons} & \\ \uparrow & \uparrow & \text{element} & \\ \text{inv}(\mathfrak{g}) \xleftarrow{\langle - \rangle} \text{inv}(b^{n-1}\mathbb{R}) & \text{invariant} & \\ & \text{polynomial} & \end{array} \right) \\
 \\
 = & \left(\begin{array}{ccc} \Omega^\bullet(U \times \Delta^k)_{\text{vert}} \xleftarrow{A_{\text{vert}}} \text{CE}(\mathfrak{g}) \xleftarrow{\mu} \text{CE}(b^{n-1}\mathbb{R}) & : \mu(A_{\text{vert}}) & \text{characteristic class} \\ \uparrow & \uparrow & \uparrow \\ \Omega^\bullet(U \times \Delta^k) \xleftarrow{A} \text{W}(\mathfrak{g}) \xleftarrow{cs} \text{W}(b^{n-1}\mathbb{R}) & : cs_\mu(A) & \text{Chern-Simons form} \\ \uparrow & \uparrow & \uparrow \\ \Omega^\bullet(U) \xleftarrow{\langle F_A \rangle} \text{inv}(\mathfrak{g}) \xleftarrow{\langle - \rangle} \text{inv}(b^{n-1}\mathbb{R}) & : \langle F_A \rangle_\mu & \text{curvature} \\ & & \text{characteristic forms} \end{array} \right).
 \end{aligned}$$

This clearly yields a morphism of simplicial presheaves

$$\exp(\mu)_{\text{conn}} : \exp(\mathfrak{g})_{\text{conn}} \rightarrow \exp(b^{n-1}\mathbb{R})_{\text{conn}}$$

and, upon restriction to the top two horizontal layers, a morphism

$$\exp(\mu)_{\text{diff}} : \exp(\mathfrak{g})_{\text{diff}} \rightarrow \exp(b^{n-1}\mathbb{R})_{\text{diff}} .$$

Projection onto the third horizontal component gives the map to the curvature classes

$$\exp(b^{n-1}\mathbb{R})_{\text{diff}} \rightarrow b_{\text{dR}} \exp(b^n \mathbb{R})_{\text{simp}} ,$$

In total, this constitutes an ∞ -anafunctor

$$\begin{array}{c} \exp(\mathfrak{g})_{\text{diff}} \xrightarrow{\exp(\mu)_{\text{diff}}} \exp(b^{n-1}\mathbb{R})_{\text{diff}} \longrightarrow b_{\text{dR}} b^n \mathbb{R} \\ \downarrow \simeq \\ \exp(\mathfrak{g}) \end{array}$$

Postcomposition with this is the simple ∞ -Chern-Weil homomorphism: it sends a cocycle

$$\begin{array}{c} C(U) \longrightarrow \exp(\mathfrak{g}) \\ \downarrow \simeq \\ X \end{array}$$

for an $\exp(\mathfrak{g})$ -principal bundle to the curvature form represented by

$$\begin{array}{c} C(V) \xrightarrow{(g, \nabla)} \exp(\mathfrak{g})_{\text{diff}} \xrightarrow{\exp(\mu)_{\text{diff}}} \exp(b^{n-1}\mathbb{R})_{\text{diff}} \longrightarrow b_{\text{dR}} b^n \mathbb{R} . \\ \downarrow \simeq \qquad \qquad \downarrow \simeq \\ C(U) \xrightarrow{g} \exp(\mathfrak{g}) \\ \downarrow \simeq \\ X \end{array}$$

Proposition 1.2.187. *For \mathfrak{g} an ordinary Lie algebra with simply connected Lie group G , the image under $\tau_1(-)$ of this diagram constitutes the ordinary Chern-Weil homomorphism in that:*

for g the cocycle for a G -principal bundle, any ordinary connection on a bundle constitutes a lift (g, ∇) to the tip of the anafunctor and the morphism represented by that is the Čech-hypercohomology cocycle on X with values in the truncated de Rham complex given by the globally defined curvature characteristic form $\langle F_\nabla \wedge \cdots \wedge F_\nabla \rangle$.

But evidently we have more information available here. The ordinary Chern-Weil homomorphism refines from a map that assigns curvature characteristic forms, to a map that assigns secondary characteristic classes in the sense that it assigns circle n -bundles with connection whose curvature is this curvature characteristic form. The local connection forms of these circle bundles are given by the middle horizontal morphisms. These are the Chern-Simons forms

$$\Omega^\bullet(U) \xleftarrow{A} \mathbf{W}(\mathfrak{g}) \xleftarrow{\text{cs}} \mathbf{W}(b^{n-1}\mathbb{R}) : \text{cs}(A) .$$

1.2.9.2.2 Secondary characteristic classes So far we discussed the untruncated coefficient object $\exp(\mathfrak{g})_{\text{conn}}$ of \mathfrak{g} -valued ∞ -connections. The real object of interest is the k -truncated version $\tau_k \exp(\mathfrak{g})_{\text{conn}}$ where $k \in \mathbb{N}$ is such that $\tau_k \exp(\mathfrak{g}) \simeq \mathbf{BG}$ is the delooping of the ∞ -Lie group in question.

Under such a truncation, the integrated ∞ -Lie algebra cocycle $\exp(\mu) : \exp(\mathfrak{g}) \rightarrow \exp(b^{n-1}\mathbb{R})$ will no longer be a simplicial map. Instead, the periods of μ will cut out a lattice Γ in \mathbb{R} , and $\exp(\mu)$ does descent to the quotient of \mathbb{R} by that lattice

$$\exp(\mu) : \tau_k \exp(\mathfrak{g}) \rightarrow \mathbf{B}^n \mathbb{R} / \Gamma.$$

We now say this again in more detail.

Suppose \mathfrak{g} is such that the $(n+1)$ -coskeleton $\mathbf{cosk}_{n+1} \exp(\mathfrak{g}) \xrightarrow{\cong} \mathbf{B}G$ for the desired G . Then the periods of μ over $(n+1)$ -balls cut out a lattice $\Gamma \subset \mathbb{R}$ and thus we get an ∞ -anafunctor

$$\begin{array}{ccccc} \mathbf{cosk}_{n+1} \exp(\mathfrak{g})_{\text{diff}} & \longrightarrow & \mathbf{B}^n \mathbb{R} / \Gamma_{\text{diff}} & \longrightarrow & b_{\text{dR}} \mathbf{B}^{n+1} \mathbb{R} / \Gamma \\ \downarrow \simeq & & & & \\ \mathbf{B}G & & & & \end{array}$$

This is *curvature characteristic class*. We may always restrict to genuine ∞ -connections and refine

$$\begin{array}{ccccc} \mathbf{cosk}_{n+1} \exp(\mathfrak{g})_{\text{conn}} & \longrightarrow & \mathbf{B}^n \mathbb{R} / \Gamma_{\text{conn}} & & \\ \downarrow & & \downarrow & & \\ \mathbf{cosk}_{n+1} \exp(\mathfrak{g})_{\text{diff}} & \longrightarrow & \mathbf{B}^n \mathbb{R} / \Gamma_{\text{diff}} & \longrightarrow & b_{\text{dR}} \mathbf{B}^{n+1} \mathbb{R} / \Gamma \\ \downarrow \simeq & & & & \\ \mathbf{B}G & & & & \end{array}$$

which models the refined ∞ -Chern-Weil homomorphism with values in ordinary differential cohomology

$$H_{\text{conn}}(X, G) \rightarrow \mathbf{H}_{\text{conn}}^{n+1}(X, \mathbb{R} / \Gamma).$$

Example 1.2.188. Applying this to the discussion of the Chern-Simons circle 3-bundle above, we find a differential refinement

$$\begin{array}{ccccc} & & \exp(\mathfrak{g})_{\text{diff}} \exp(\mu)_{\text{diff}} & \longrightarrow & \exp(b^{n-1}\mathbb{R})_{\text{diff}} \cdot \\ & & \downarrow & & \downarrow f_{\Delta^\bullet} \\ C(V) & \xrightarrow{(\hat{g}, \hat{\nabla})} & \mathbf{cosk}_3 \exp(\mathfrak{g})_{\text{diff}} & \longrightarrow & \mathbf{B}^3 U(1)_{\text{diff}} \\ \downarrow \simeq & & \downarrow & & \\ C(U) & \xrightarrow{(g, \nabla)} & \mathbf{B}G_{\text{diff}} & & \\ \downarrow \simeq & & & & \\ X & & & & \end{array}$$

Chasing components through this composite one finds that this describes the cocycle in Deligne cohomology given by

$$(CS(\sigma_i^* \nabla), \int_{\Delta^1} CS(\hat{g}_{ij}^* \nabla), \int_{\Delta^2} CS(\hat{g}_{ijk}^* \nabla), \int_{\Delta^3} \hat{g}_{ijkl}^* \mu).$$

This is the cocycle for the circle n -bundle with connection.

This is precisely the form of the Čech-Deligne cocycle for the first Pontryagin class given in [BrMc96b], only that here it comes out automatically normalized such as to represent the fractional generator $\frac{1}{2}\mathbf{p}_1$.

By feeding in more general transgressive ∞ -Lie algebra cocycles through this machine, we obtain cocycles for more general differential characteristic classes. For instance the next one is the second fractional Pontryagin class of String-2-bundles with connection [FSS10]. Moreover, these constructions naturally yield the full cocycle ∞ -groupoids, not just their cohomology sets. This allows us to form the homotopy fibers of the ∞ -Chern-Weil homomorphism and thus define *differential string structures* etc. and *twisted differential string structures* etc. [SSS09c].

1.2.10 Hamilton-Jacobi-Lagrange mechanics via prequantized Lagrangian correspondences

We show here how classical mechanics – Hamiltonian mechanics, Lagrangian mechanics, Hamilton-Jacobi theory, see e.g. [Ar89] – naturally arises from and is accurately captured by “pre-quantized Lagrangian correspondences”. Since field theory is a refinement of classical mechanics, this serves also as a blueprint for the discussion of De Donder-Weyl-style classical field theory by higher correspondences below in 1.2.11, and more generally for the discussion of local prequantum field theory in [FRS13a, Nui13, Sc13b].

The reader unfamiliar with classical mechanics may take the following to be a brief introduction to and indeed a systematic derivation of the central concepts of classical mechanics from the notion of correspondences in slice toposes. Conversely, the reader familiar with classical mechanics may take the translation of classical mechanics into correspondences in slice toposes as the motivating example for the formalization of prequantum field theory in [Sc13b]. The translation is summarized as a diagrammatic dictionary below in 1.2.10.11.

The following sections all follow, in their titles, the pattern

Physical concept and mathematical formalization

and each first recalls a naive physical concept, then motivates its mathematical formalization, then discusses this formalization and how it reflects back on the understanding of the physics.

- 1.2.10.1 – Phase spaces and symplectic manifolds;
- 1.2.10.2 – Coordinate systems and the topos of smooth spaces;
- 1.2.10.3 – Coordinate transformations and symplectomorphisms;
- 1.2.10.4 – Trajectories and Lagrangian correspondences;
- 1.2.10.5 – Observables, symmetries, and the Poisson bracket Lie algebra;
- 1.2.10.6 – Hamiltonian (time evolution) correspondence and Hamiltonian correspondence;
- 1.2.10.7 – Noether symmetries and equivariant structure;
- 1.2.10.8 – Gauge symmetry, smooth groupoids and higher toposes;
- 1.2.10.9 – The kinetic action, prequantization and differential cohomology;
- 1.2.10.10 – The classical action, the Legendre transform and Hamiltonian flows;
- 1.2.10.11 – The classical action functional pre-quantizes Lagrangian correspondences;
- 1.2.10.12 – Quantization, the Heisenberg group and slice automorphism groups;
- 1.2.10.13 – Integrable systems, moment maps, and maps into the Poisson bracket;
- 1.2.10.14 – Classical anomalies and projective symplectic reduction;

Historical comment. Much of the discussion here is induced by just the notion of *pre-quantized Lagrangian correspondences*. The notion of plain Lagrangian correspondences (not pre-quantized) has been observed already in the early 1970s to usefully capture central aspects of Fourier transformation theory [Hö71] and of classical mechanics [We71], notably to unify the notion of Lagrangian subspaces of phase spaces with that of “canonical transformations”, hence symplectomorphisms, between them. This observation has since been particularly advertized by Weinstein (e.g [We83]), who proposed that some kind of *symplectic category* of symplectic manifolds with Lagrangian correspondences between them should be a good domain for a formalization of *quantization* along the lines of geometric quantization. Several authors have since discussed aspects of this idea. A recent review in the context of field theory is in [CMR12b].

But geometric quantization proper proceeds not from plain symplectic manifolds but from a lift of their symplectic form to a cocycle in differential cohomology, called a *pre-quantization* of the symplectic manifold. Therefore it is to be expected that some notion of pre-quantized Lagrangian correspondences, which put into correspondence these prequantum bundles and not just their underlying symplectic manifolds, is a more natural domain for geometric quantization, hence a more accurate formalization of pre-quantum geometry.

There is an evident such notion of prequantization of Lagrangian correspondences, and this is what we introduce and discuss in the following. While evident, it seems that it has previously found little attention in the literature, certainly not attention comparable to the fame enjoyed by Lagrangian correspondences. But it should. As we show now, classical mechanics globally done right is effectively identified with the study of prequantized Lagrangian correspondences.

1.2.10.1 Phase spaces and symplectic manifolds Given a physical system, one says that its *phase space* is the space of its possible (“classical”) histories or trajectories. Newton’s second law of mechanics says that trajectories of physical systems are (typically) determined by differential equations of *second* order, and therefore these spaces of trajectories are (typically) equivalent to initial value data of 0th and of 1st derivatives. In physics this data (or rather its linear dual) is referred to as the *canonical coordinates* and the *canonical momenta*, respectively, traditionally denoted by the symbols “*q*” and “*p*”. Being coordinates, these are actually far from being canonical in the mathematical sense; all that has invariant meaning is, locally, the surface element $\mathbf{d}p \wedge \mathbf{d}q$ spanned by a change of coordinates and momenta.

Made precise, this says that a physical phase space is a sufficiently smooth manifold X which is equipped with a closed and non-degenerate differential 2-form $\omega \in \Omega_{\text{cl}}^2(X)$, hence that phase spaces are *symplectic manifolds* (X, ω) .

Example 1.2.189. The simplest nontrivial example is the phase space $\mathbb{R}^2 \simeq T^*\mathbb{R}$ of a single particle propagating on the real line. The standard coordinates on the plane are traditionally written $q, p : \mathbb{R}^2 \rightarrow \mathbb{R}$ and the symplectic form is the canonical volume form $\mathbf{d}q \wedge \mathbf{d}p$.

This is a special case of the following general and fundamental definition of *covariant phase spaces* (whose history is long and convoluted, two references being [Zu87, CrWi87]).

Example 1.2.190 (covariant phase space). Let F be a smooth manifold – to be called the *field fiber* – and write $[\Sigma_1, F]$ for the manifold of smooth maps from the closed interval $\Sigma_1 := [0, 1] \hookrightarrow \mathbb{R}$ into F (an infinite-dimensional Fréchet manifold). We think of F as a space of *spatial field configurations* and of $[\Sigma_1, F]$ as the space of *trajectories* or *histories* of spatial field configurations. Specifically, we may think of $[\Sigma_1, F]$ as the space of trajectories of a particle propagating in a space(-time) F .

A smooth function

$$L : [\Sigma_1, F] \rightarrow \Omega^1(\Sigma_1)$$

to the space of differential 1-forms on Σ_1 is called a *local Lagrangian* of fields in F if for all $t \in \Sigma_1$ the assignment $\gamma \mapsto L_\gamma(t)$ is a smooth function of $\gamma(t), \dot{\gamma}(t), \ddot{\gamma}(t), \dots$ (hence of the value of a curve $\gamma : \Sigma_1 \rightarrow F$ at t and of the values of all its derivatives at t). One traditionally writes

$$L : \gamma \mapsto L(\gamma, \dot{\gamma}, \ddot{\gamma}, \dots) \wedge \mathbf{d}t$$

to indicate this. In cases of interest typically only first derivatives appear

$$L : \gamma \mapsto L(\gamma, \dot{\gamma}) \wedge \mathbf{d}t$$

and we concentrate on this case now for notational simplicity. Given such a local Lagrangian, the induced *local action functional* $S : [\Sigma_1, F] \rightarrow \mathbb{R}$ is the smooth function on trajectory space which is given by integrating the local Lagrangian over the interval:

$$S = \int_{\Sigma_1} L : [\Sigma_1, F] \xrightarrow{L} \Omega^1(\Sigma_1) \xrightarrow{\int_I} \mathbb{R}.$$

The *variational derivative* of the local Lagrangian is the smooth differential 2-form

$$\delta L \in \Omega^{1,1}([\Sigma_1, F] \times \Sigma_1)$$

on the product of trajectory space and parameter space, which is given by the expression

$$\begin{aligned} \delta L_\gamma &= \frac{\partial L}{\partial \gamma} \wedge \mathbf{d}t \wedge \delta\gamma + \frac{\partial L}{\partial \dot{\gamma}} \wedge \mathbf{d}t \wedge \frac{d}{dt} \wedge \delta\gamma \\ &= \underbrace{\left(\frac{\partial L}{\partial \gamma} - \frac{\partial}{\partial t} \frac{\partial L}{\partial \dot{\gamma}} \right)}_{=: \text{EL}_\gamma} \mathbf{d}t \wedge \delta\gamma + \frac{d}{dt} \underbrace{\left(\frac{\partial L}{\partial \dot{\gamma}} \wedge \delta\gamma \right)}_{=: \theta_\gamma} \mathbf{d}t. \end{aligned}$$

One says that $\text{EL}_\gamma = 0$ (for all $t \in I$) is the *Euler-Lagrange equation of motion* induced by the local Lagrangian L , and that the 0-locus

$$X := \{\gamma \in [\Sigma_1, F] \mid \text{EL}_\gamma = 0\} \hookrightarrow [\Sigma_1, F]$$

(also called the “shell”) equipped with the 2-form

$$\omega := \delta\theta$$

is the *unreduced covariant phase space* (X, ω) induced by L .

Example 1.2.191. Consider the case that $F = \mathbb{R}$ and that the Lagrangian is of the form

$$\begin{aligned} L &:= L_{\text{kin}} - L_{\text{pot}} \\ &:= \left(\frac{1}{2} \dot{\gamma}^2 - V(\gamma) \right) \wedge \mathbf{d}t, \end{aligned}$$

hence is a quadratic form on the first derivatives of the trajectory – called the *kinetic energy density* – plus any smooth function V of the trajectory position itself – called (minus) the *potential energy density*. Then the corresponding phase space is equivalent to $\mathbb{R}^2 \simeq T^*\mathbb{R}$ with the canonical coordinates identified with the initial value data

$$q := \gamma(0), \quad p = \dot{\gamma}$$

and with

$$\theta = p \wedge \mathbf{d}q$$

and hence

$$\omega = \mathbf{d}q \wedge \mathbf{d}p.$$

This is the phase space of example 1.2.189. Notice that the symplectic form here is a reflection entirely only of the kinetic action, independent of the potential action. This we come back to below in 1.2.10.9.

Remark 1.2.192. The differential 2-form ω on an unreduced covariant phase space in example 1.2.190 is closed, even exact, but in general far from non-degenerate, hence far from being symplectic. We may say that (X, ω) is a *pre-symplectic manifold*. This is because this differential form measures the reaction of the Lagrangian/action functional to variations of the fields, but the action functional may be *invariant* under some variation of the fields; one says that it has (*gauge-*)*symmetries*. To obtain a genuine symplectic form one needs to quotient out the flow of these symmetries from unreduced covariant phase space to obtain the *reduced* covariant phase space. This we turn to below in 1.2.10.7.

Remark 1.2.193. In the description of the mechanics of just particles, the Lagrangian L above has no further more fundamental description, it is just what it is. But in applications to n -dimensional *field* theory the differential 1-forms L and θ in example 1.2.190 arise themselves from integration of differential n -forms over space (Cauchy surfaces), hence from *transgression* of higher-degree data in higher codimension. This we describe in example 1.2.279 below. Since transgression in general loses some information, one should really work locally instead of integrating over Cauchy surfaces, hence work with the de-transgressed data and develop classical field theory for that. This we turn to below in 1.2.11 for classical field theory and then more generally for local prequantum field theory in [Sc13b].

1.2.10.2 Coordinate systems and the topos of smooth spaces When dealing with spaces X that are equipped with extra structure, such as a closed differential 2-form $\omega \in \Omega_{\text{cl}}^2(X)$, then it is useful to have a *universal moduli space* for these structures, and this will be central for our developments here. So we need a “smooth space” Ω_{cl}^2 of sorts, characterized by the property that there is a natural bijection between smooth closed differential 2-forms $\omega \in \Omega_{\text{cl}}^2(X)$ and smooth maps $X \longrightarrow \Omega_{\text{cl}}^2$. Of course such a universal moduli spaces of closed 2-forms does not exist in the category of smooth manifolds. But it does exist canonically if we slightly generalize the notion of “smooth space” suitably (the following is discussed in more detail below in 1.2.2).

Definition 1.2.194. A *smooth space* or *smooth 0-type* X is

1. an assignment to each $n \in \mathbb{N}$ of a set, to be written $X(\mathbb{R}^n)$ and to be called the *set of smooth maps from \mathbb{R}^n into X* ,
2. an assignment to each ordinary smooth function $f : \mathbb{R}^{n_1} \rightarrow \mathbb{R}^{n_2}$ between Cartesian spaces of a function of sets $X(f) : X(\mathbb{R}^{n_2}) \rightarrow X(\mathbb{R}^{n_1})$, to be called the *pullback of smooth functions into X along f* ;

such that

1. this assignment respects composition of smooth functions;
2. this assignment respect the covering of Cartesian spaces by open disks: for every good open cover $\{\mathbb{R}^n \simeq U_i \hookrightarrow \mathbb{R}^n\}_i$, the set $X(\mathbb{R}^n)$ of smooth functions out of \mathbb{R}^n into X is in natural bijection with the set $\{(\phi_i)_i \in \prod_i X(U_i) \mid \forall_{i,j} \phi_i|_{U_i \cap U_j} = \phi_j|_{U_i \cap U_j}\}$ of tuples of smooth functions out of the patches of the cover which agree on all intersections of two patches.

Remark 1.2.195. One may think of definition 1.2.194 as a formalization of the common idea in physics that we understand spaces by charting them with coordinate systems. A Cartesian space \mathbb{R}^n is nothing but the standard n -dimensional coordinate system and one may think of the set $X(\mathbb{R}^n)$ above as the set of all possible ways (including all degenerate ways) of laying out this coordinate system in the would-be space X . Moreover, a function $f : \mathbb{R}^{n_1} \rightarrow \mathbb{R}^{n_2}$ is nothing but a *coordinate transformation* (possibly degenerate), and hence the corresponding functions $X(f) : X(\mathbb{R}^{n_2}) \rightarrow X(\mathbb{R}^{n_1})$ describe how the probes of X by coordinate systems change under coordinate transformations. Definition 1.2.194 takes the idea that any space in physics should be probe-able by coordinate systems in this way to the extreme, in that it *defines* a smooth spaces as a collection of probes by coordinate systems equipped with information about all possible coordinate transformations.

The notion of smooth spaces is maybe more familiar with one little axiom added:

Definition 1.2.196. A smooth space X is called *concrete* if there exists a set $X_{\text{disc}} \in \text{Set}$ such that for each $n \in \mathbb{N}$ the set $X(\mathbb{R}^n)$ of smooth functions from \mathbb{R}^n to X is a subset of the set of *all* functions from the underlying set of \mathbb{R}^n to the set $X_{\text{disc}} \in \text{Set}$.

This definition of concrete smooth spaces goes back to [Chen77] in various slight variants, see [St08] for a comparative discussion. A comprehensive textbook account of differential geometry formulated with this definition of smooth spaces (called “diffeological spaces” there) is in [Ig13].

While the formulation of def. 1.2.194 is designed to make transparent its geometric meaning, of course equivalently but more abstractly this says the following:

Definition 1.2.197. Write CartSp for the category of Cartesian spaces with smooth functions between them, and consider it equipped with the coverage (Grothendieck pre-topology) of good open covers. A *smooth space* or *smooth 0-type* is a sheaf on this site. The *topos of smooth 0-types* is the sheaf category

$$\text{Smooth0Type} := \text{PSh}(\text{CartSp})[\{\text{covering maps}\}^{-1}].$$

In the following we will abbreviate the notation to

$$\mathbf{H} := \text{Smooth0Type}.$$

For the discussion of pre-symplectic manifolds, we need the following two examples.

Example 1.2.198. Every smooth manifold $X \in \text{SmoothManifold}$ becomes a smooth 0-type by the assignment

$$X : n \mapsto C^\infty(\mathbb{R}^n, X).$$

(This defines in fact a concrete smooth space, def. 1.2.196, the underlying set X_{disc} being just the underlying set of points of the given manifold.) This construction extends to a full and faithful embedding of smooth manifolds into smooth 0-types

$$\text{SmoothManifold} \hookrightarrow \mathbf{H}.$$

The other main example is in a sense at an opposite extreme in the space of all examples. It is given by smooth moduli space of *differential forms*, see the discussion in 1.2.3.

Example 1.2.199. For $p \in \mathbb{N}$, write Ω_{cl}^p for the smooth space given by the assignment

$$\Omega_{\text{cl}}^p : n \mapsto \Omega_{\text{cl}}^p(\mathbb{R}^n)$$

and by the evident pullback maps of differential forms. These smooth spaces Ω_{cl}^n are *not* concrete, def. 1.2.196. In fact they are maximally non-concrete in that there is only a single smooth map $*$ $\rightarrow \Omega_{\text{cl}}^n$ from the point into them. Hence the underlying point set of the smooth space Ω_{cl}^n looks like a singleton, and yet these smooth spaces are far from being the trivial smooth space: they admit many smooth maps $X \rightarrow \Omega_{\text{cl}}^n$ from smooth manifolds of dimension at least n , as the following prop. 1.2.200 shows.

This solves the moduli problem for closed smooth differential forms:

Proposition 1.2.200. For $p \in \mathbb{N}$ and $X \in \text{SmoothManifold} \hookrightarrow \text{Smooth0Type}$, there is a natural bijection

$$\mathbf{H}(X, \Omega_{\text{cl}}^p) \simeq \Omega_{\text{cl}}^p(X).$$

So a pre-symplectic manifold (X, ω) is equivalently a map of smooth spaces of the form

$$\omega : X \longrightarrow \Omega_{\text{cl}}^2.$$

1.2.10.3 Canonical transformations and Symplectomorphisms An equivalence between two phase spaces, hence a re-expression of the “canonical” coordinates and momenta, is called a *canonical transformation* in physics. Mathematically this is a *symplectomorphism*:

Definition 1.2.201. Given two (pre-)symplectic manifolds (X_1, ω_1) and (X_2, ω_2) a *symplectomorphism*

$$f : (X_1, \omega_1) \longrightarrow (X_2, \omega_2)$$

is a diffeomorphism $f : X_1 \longrightarrow X_2$ of the underlying smooth spaces, which respects the differential forms in that

$$f^* \omega_2 = \omega_1 .$$

The formulation above in 1.2.10.2 of pre-symplectic manifolds as maps into a moduli space of closed 2-forms yields the following equivalent re-formulation of symplectomorphisms, which is very simple in itself, but contains in it the seed of an important phenomenon:

Proposition 1.2.202. *Given two symplectic manifolds (X_1, ω_1) and (X_2, ω_2) , a symplectomorphism $\phi : (X_1, \omega_1) \rightarrow (X_2, \omega_2)$ is equivalently a commuting diagram of smooth spaces of the following form:*

$$\begin{array}{ccc} X_1 & \xrightarrow{\phi} & X_2 \\ & \searrow \omega_1 & \swarrow \omega_2 \\ & \Omega_{\text{cl}}^2 & \end{array} .$$

Situations like this are naturally interpreted in the *slice topos*:

Definition 1.2.203. For $A \in \mathbf{H}$ any smooth space, the *slice topos* $\mathbf{H}/_A$ is the category whose objects are objects $X \in \mathbf{H}$ equipped with maps $X \rightarrow A$, and whose morphisms are commuting diagrams in \mathbf{H} of the form

$$\begin{array}{ccc} X & \longrightarrow & Y \\ & \searrow & \swarrow \\ & A & \end{array} .$$

Hence if we write SymplManifold for the category of smooth pre-symplectic manifolds and symplectomorphisms between them, then we have the following.

Proposition 1.2.204. *The construction of prop. 1.2.200 constitutes a full embedding*

$$\text{SymplManifold} \hookrightarrow \mathbf{H}/_{\Omega_{\text{cl}}^2}$$

of pre-symplectic manifolds with symplectomorphisms between them into the slice topos of smooth spaces over the smooth moduli space of closed differential 2-forms.

1.2.10.4 Trajectories and Lagrangian correspondences A symplectomorphism clearly puts two symplectic manifolds “in relation” to each other. It turns out to be useful to say this formally. Recall:

Definition 1.2.205. For $X, Y \in \text{Set}$ two sets, a relation R between elements of X and elements of Y is a subset of the Cartesian product set

$$R \hookrightarrow X \times Y .$$

More generally, for $X, Y \in \mathbf{H}$ two objects of a topos (such as the topos of smooth spaces), then a relation R between them is a subobject of their Cartesian product

$$R \hookrightarrow X \times Y .$$

In particular any function induces the relation “ y is the image of x ”:

Example 1.2.206. For $f : X \rightarrow Y$ a function, its *induced relation* is the relation which is exhibited by *graph* of f

$$\text{graph}(f) := \{(x, y) \in X \times Y \mid f(x) = y\}$$

canonically regarded as a subobject

$$\text{graph}(f) \hookrightarrow X \times Y.$$

Hence in the context of classical mechanics, in particular any symplectomorphism $f : (X_1, \omega_1) \rightarrow (X_2, \omega_2)$ induces the relation

$$\text{graph}(f) \hookrightarrow X_1 \times X_2.$$

Since we are going to think of f as a kind of “physical process”, it is useful to think of the smooth space $\text{graph}(f)$ here as the *space of trajectories* of that process. To make this clearer, notice that we may equivalently rewrite every relation $R \hookrightarrow X \times Y$ as a diagram of the following form:

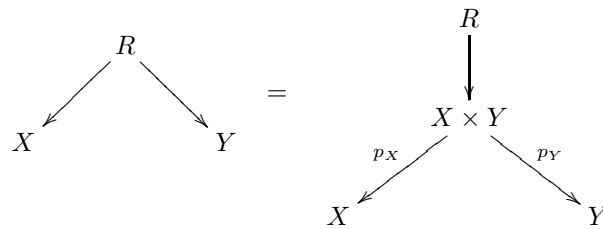

reflecting the fact that every element $(x \sim y) \in R$ defines an element $x = p_X(x \sim y) \in X$ and an element $y = p_Y(x \sim y) \in Y$.

Then if we think of the space $R = \text{graph}(f)$ of example 1.2.206 as being a space of trajectories starting in X_1 and ending in X_2 , then we may read the relation as “there is a trajectory from an incoming configuration x_1 to an outgoing configuration x_2 ”:

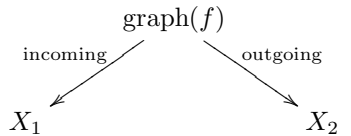

Notice here that the defining property of a relation as a subset/subobject translates into the property of classical physics that there is *at most one trajectory* from some incoming configuration x_1 to some outgoing trajectory x_2 (for a fixed and small enough parameter time interval at least, we will formulate this precisely in the next section when we genuinely consider Hamiltonian correspondences).

In a more general context one could consider there to be several such trajectories, and even a whole smooth space of such trajectories between given incoming and outgoing configurations. Each such trajectory would “relate” x_1 to x_2 , but each in a possible different way. We can also say that each trajectory makes x_1 *correspond* to x_2 in a different way, and that is the mathematical term usually used:

Definition 1.2.207. For $X, Y \in \mathbf{H}$ two spaces, a *correspondence* between them is a diagram in \mathbf{H} of the form

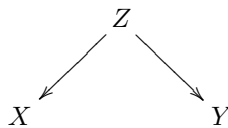

with no further restrictions. Here Z is also called the *correspondence space*.

Observe that the graph of a function $f: X \rightarrow Y$ is, while defined differently, in fact equivalent to just the space X , the equivalence being induced by the map $x \mapsto (x, f(x))$

$$X \xrightarrow{\simeq} \text{graph}(f).$$

In fact the relation/correspondence which expresses “ y is the image of f under x ” may just as well be exhibited by the diagram

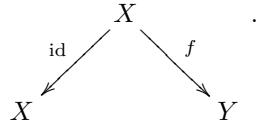

It is clear that this correspondence with correspondence space X should be regarded as being equivalent to the one with correspondence space $\text{graph}(f)$. We may formalize this as follows

Definition 1.2.208. Given two correspondences $X \longleftarrow Z_1 \longrightarrow Y$ and $X \longleftarrow Z_2 \longrightarrow Y$ between the same objects in \mathbf{H} , then an equivalence between them is an equivalence $Z_1 \xrightarrow{\simeq} Z_2$ in \mathbf{H} which fits into a commuting diagram of the form

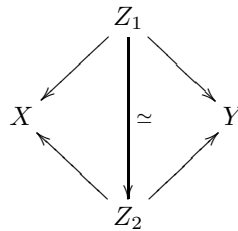

Example 1.2.209. Given an function $f: X \rightarrow Y$ we have the commuting diagram

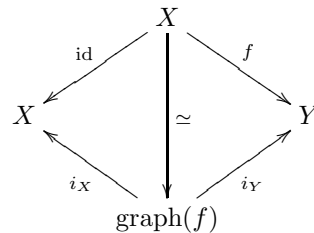

exhibiting an equivalence of the correspondence at the top with that at the bottom.

Correspondences between X any Y with such equivalences between them form a *groupoid*. Hence we write

$$\text{Corr}(\mathbf{H})(X, Y) \in \text{Grpd}.$$

Moreover, if we think of correspondences as modelling spaces of trajectories, then it is clear that their should be a notion of composition:

$$\left(\begin{array}{ccccc} & Y_1 & & Y_2 & \\ & \swarrow & & \swarrow & \\ X_1 & & X_2 & & X_3 \end{array} \right) \mapsto \left(\begin{array}{ccc} & Y_1 \circ_{X_2} Y_2 & \\ & \swarrow & \searrow \\ X_1 & & X_3 \end{array} \right).$$

Heuristically, the composite space of trajectories $Y_1 \circ_{X_2} Y_2$ should consist precisely of those pairs of trajectories $(f, g) \in Y_1 \times Y_2$ such that the endpoint of f is the starting point of g . The space with this property is

precisely the *fiber product* of Y_1 with Y_2 over X_2 , denoted $Y_1 \times_{X_2} Y_2$ (also called the *pullback* of $Y_2 \rightarrow X_2$ along $Y_1 \rightarrow X_2$):

$$\left(\begin{array}{ccc} & Y_1 \circ_{X_2} Y_2 & \\ \swarrow & & \searrow \\ X_1 & & X_3 \end{array} \right) = \left(\begin{array}{ccccc} & & Z_1 \times_Y Z_2 & & \\ & \swarrow & & \searrow & \\ & Z_1 & & Z_2 & \\ \swarrow & & \searrow & \swarrow & \searrow \\ X_1 & & X_2 & & X_3 \end{array} \right).$$

Hence given a topos \mathbf{H} , correspondences between its objects form a category which composition the fiber product operation, where however the collection of morphisms between any two objects is not just a set, but is a groupoid (the groupoid of correspondences between two given objects and equivalences between them).

One says that correspondences form a $(2, 1)$ -category

$$\text{Corr}(\mathbf{H}) \in (2, 1)\text{Cat}.$$

One reason for formalizing this notion of correspondences so much in the present context that it is useful now to apply it not just to the ambient topos \mathbf{H} of smooth spaces, but also to its slice topos $\mathbf{H}/\Omega_{\text{cl}}^2$ over the universal moduli space of closed differential 2-forms.

To see how this is useful in the present context, notice the following

Proposition 1.2.210. *Let $\phi : (X_1, \omega_1) \rightarrow (X_2, \omega_2)$ be a symplectomorphism. Write*

$$(i_1, i_2) : \text{graph}(\phi) \hookrightarrow X_1 \times X_2$$

for the graph of the underlying diffeomorphism. This fits into a commuting diagram in \mathbf{H} of the form

$$\begin{array}{ccc} & \text{graph}(\phi) & \\ i_1 \swarrow & & \searrow i_2 \\ X_1 & & X_2 \\ \omega_1 \searrow & \parallel & \swarrow \omega_2 \\ & \Omega_{\text{cl}}^2 & \end{array} .$$

Conversely, a smooth function $\phi : X_1 \rightarrow X_2$ is a symplectomorphism precisely if its graph makes the above diagram commute.

Traditionally this is formalized as follows.

Definition 1.2.211. Given a symplectic manifold (X, ω) , a submanifold $L \hookrightarrow X$ is called a *Lagrangian submanifold* if $\omega|_L = 0$ and if L has dimension $\dim(L) = \dim(X)/2$.

Definition 1.2.212. For (X_1, ω_1) and (X_2, ω_2) two symplectic manifolds, a correspondence $X_1 \xleftarrow{p_1} Y \xrightarrow{p_2} X_2$ of the underlying manifolds is a *Lagrangian correspondence* if the map $Y \rightarrow X_1 \times X_2$ exhibits a Lagrangian submanifold of the symplectic manifold given by $(X_1 \times X_2, p_2^* \omega_2 - p_1^* \omega_1)$.

Given two Lagrangian correspondence which intersect transversally over one adjacent leg, then their *composition* is the correspondence given by the intersection.

But comparison with def. 1.2.203 shows that Lagrangian correspondences are in fact plain correspondences, just not in smooth spaces, but in the slice $\mathbf{H}/\Omega_{\text{cl}}^2$ of all smooth spaces over the universal smooth moduli space of closed differential 2-forms:

Proposition 1.2.213. *Under the identification of prop. 1.2.204 the construction of the diagrams in prop. 1.2.210 constitutes an injection of Lagrangian correspondence between (X_1, ω_1) and (X_2, ω_2) into the Hom-space $\text{Corr}(\mathbf{H}/\Omega_{\text{cl}}^2)((X_1, \omega_1), (X_2, \omega_2))$. Moreover, composition of Lagrangian correspondence, when defined, coincides under this identification with the composition of the respective correspondences.*

Remark 1.2.214. The composition of correspondences in the slice topos is always defined. It may just happen the composite is given by a correspondence space which is a smooth space but not a smooth manifold. Or better, one may replace in the entire discussion the topos of smooth spaces with a topos of “derived” smooth spaces, modeled not on Cartesian spaces but on Cartesian dg-manifolds. This will then automatically make composition of Lagrangian correspondences take care of “transversal perturbations”. Here we will not further dwell on this possibility. In fact, the formulation of Lagrangian correspondences and later of prequantum field theory by correspondences in toposes implies a great freedom in the choice of type of geometry in which set up everything. (The bare minimum condition on the topos \mathbf{H} which we need to require is that it be *differentially cohesive*, 3.5).

It is also useful to make the following phenomenon explicit, which is the first incarnation of a recurring theme in the following discussions.

Proposition 1.2.215. *The category $\text{Corr}(\mathbf{H}/\Omega_{\text{cl}}^2)$ is naturally a symmetric monoidal category, where the tensor product is given by*

$$(X_1, \omega_1) \otimes (X_2, \omega_2) = (X_1 \times X_2, \omega_1 + \omega_2).$$

The tensor unit is $(, 0)$. With respect to this tensor product, every object is dualizable, with dual object given by*

$$(X, \omega)^v = (X, -\omega).$$

Remark 1.2.216. Duality induces natural equivalences of the form

$$\text{Corr}(\mathbf{H}/\Omega_{\text{cl}}^2)((X_1, \omega_1), (X_2, \omega_2),) \xrightarrow{\simeq} \text{Corr}(\mathbf{H}/\Omega_{\text{cl}}^2)((*, 0), (X_1 \times X_2, \omega_2 - \omega_1),).$$

Under this equivalence an isotropic (Lagrangian) correspondences which in \mathbf{H} is given by a diagram as in prop. 1.2.210 maps to the diagram of the form

$$\begin{array}{ccc}
 & \text{graph}(\phi) & \\
 & \swarrow & \searrow \\
 * & & X_1 \times X_2 \\
 & \searrow & \swarrow \\
 & \Omega_{\text{cl}}^2 & \\
 & \swarrow & \searrow \\
 & & *
 \end{array}$$

$\xrightarrow{(i_1, i_2)}$ (top right arrow)
 $\xrightarrow{0}$ (bottom left arrow)
 $\xrightarrow{\omega_2 - \omega_1}$ (bottom right arrow)

This makes the condition that the pullback of the difference $\omega_2 - \omega_1$ vanishes on the correspondence space more manifest. It is also the blueprint of a phenomenon that is important in the generalization to field theory in the sections to follow, where trajectories map to boundary conditions, and vice versa.

1.2.10.5 Observables, symmetries and the Poisson bracket Lie algebra Given a phase space (X, ω) of some physical system, then a function $O : X \rightarrow \mathbb{R}$ is an assignment of a value to every possible state (phase of motion) of that system. For instance it might assign to every phase of motion its position (measured in some units with respect to some reference frame), or its momentum, or its energy. The premise of classical physics is that all of these quantities may in principle be observed in experiment, and therefore functions on phase space are traditionally called *classical observables*. Often this is abbreviated to just

observables if the context is understood (the notion of observable in quantum mechanics and quantum field theory is more subtle, for a formalization of quantum observables in terms of correspondences in cohesive homotopy types see [Nui13]).

While this is the immediate physics heuristics about what functions on phase space are, it turns out that a central characteristic of mechanics and of field theory is an intimate relation between the observables of a mechanical system and its *infinitesimal symmetry transformations*: an infinitesimal symmetry transformation of a phase space characterizes that observable of the system which is invariant under the symmetry transformation. Mathematically this relation is captured by the structure of a Lie algebra on the vector space of all observables after relating them to their *Hamiltonian vector fields*.

Definition 1.2.217. Given a symplectic manifold (X, ω) and a function $H : X \rightarrow \mathbb{R}$, its *Hamiltonian vector field* is the unique $v \in \Gamma(TX)$ which satisfies *Hamilton's equation of motion*

$$\mathbf{d}H = \iota_v \omega .$$

Example 1.2.218. For $(X, \omega) = (\mathbb{R}^2, \mathbf{d}q \wedge \mathbf{d}p)$ the 2-dimensional phase space form example 1.2.189, and for $t \mapsto (q(t), p(t)) \in X$ a curve, it is a Hamiltonian flow line if its tangent vectors $(\dot{q}(t), \dot{p}(t)) \in T_{(q(t), p(t))} \mathbb{R}^2 \simeq \mathbb{R}^2$ satisfy Hamilton's equations in the classical form:

$$\dot{q} = \frac{\partial H}{\partial p} ; \quad \dot{p} = -\frac{\partial H}{\partial q} .$$

Proposition 1.2.219. *Given a symplectic manifold (X, ω) , every Hamiltonian vector field v is an infinitesimal symmetry of (X, ω) – an infinitesimal symplectomorphism – in that the Lie derivative of the symplectic form along v vanishes*

$$\mathcal{L}_v \omega = 0 .$$

Proof. Using Cartan's formula for the Lie derivative

$$\mathcal{L}_v = \mathbf{d} \circ \iota_v + \iota_v \circ \mathbf{d}$$

and the defining condition that the symplectic form is closed and that there is a function H with $\mathbf{d}H = \iota_v \omega$, one finds that the Lie derivative of ω along v is given by

$$\mathcal{L}_v \omega = \mathbf{d} \iota_v \omega + \iota_v \mathbf{d} \omega = \mathbf{d}^2 H = 0 .$$

□

Since infinitesimal symmetries should form a Lie algebra, this motivates the following definition.

Definition 1.2.220 (Poisson bracket for symplectic manifolds). Let (X, ω) be a symplectic manifold. Given two functions $f, g \in C^\infty(X)$ with Hamiltonian vector fields v and w , def. 1.2.217, respectively, their *Poisson bracket* is the function obtained by evaluating the symplectic form on these two vector fields

$$\{f, g\} := \iota_w \iota_v \omega .$$

This operation

$$\{-, -\} : C^\infty(X) \otimes C^\infty(X) \longrightarrow C^\infty(X)$$

is skew symmetric and satisfies the Jacobi identity. Therefore

$$\mathbf{pois}(X, \omega) := (C^\infty(X), \{-, -\})$$

is a Lie algebra (infinite dimensional in general), called the *Poisson bracket Lie algebra of classical observables* of the symplectic manifold X .

Remark 1.2.221. Below in 1.2.10.12 we indicate a general abstract characterization of the Poisson bracket Lie algebra (which is discussed in more detail below in 3.9.13.5): it is the Lie algebra of “the automorphism group of any prequantization of (X, ω) in the higher slice topos over the moduli stack of circle-principal connections” [FRS13a]. To state this we first need the notion of *pre-quantization* which we come to below in 1.2.10.9. In the notation introduced there we will discuss in 1.2.10.12 that the Poisson bracket is given as

$$\mathfrak{pois}(X, \omega) = \text{Lie} \left(\mathbf{Aut}_{/\mathbf{BU}(1)_{\text{conn}}}(\nabla) \right) = \left\{ \begin{array}{ccc} X & \xrightarrow{\quad \simeq \quad} & X \\ & \swarrow \quad \searrow & \\ & \nabla \quad \quad \nabla & \\ & \mathbf{BU}(1)_{\text{conn}} & \end{array} \right\},$$

where ∇ denotes a pre-quantization of (X, ω) .

This general abstract construction makes sense also for pre-symplectic manifolds and shows that the following slight generalization of the above traditional definition is good and useful.

Definition 1.2.222 (Poisson bracket for pre-symplectic manifolds). For (X, ω) a pre-symplectic manifold, denote by $\mathfrak{pois}(X, \omega)$ the Lie algebra whose underlying vector space is the space of pairs of Hamiltonians H with a *choice* of Hamiltonian vector field v

$$\{(v, H) \in \Gamma(TX) \otimes C^\infty(X) \mid \iota_v \omega = \mathbf{d}H\},$$

and whose Lie bracket is given by

$$[(v_1, H_1), (v_2, H_2)] = ([v_1, v_2], \iota_{v_1 \wedge v_2} \omega).$$

Remark 1.2.223. On a smooth manifold X there is a bijection between smooth vector fields and derivations of the algebra $C^\infty(X)$ of smooth functions, given by identifying a vector field v with the operation $v(-)$ of differentiating functions along v . Under this identification the Hamiltonian vector field v corresponding to a Hamiltonian H is identified with the derivation given by forming the Poisson bracket with H :

$$v(-) = \{H, -\} : C^\infty(X) \longrightarrow C^\infty(X).$$

In applications in physics, given a phase space (X, ω) typically one smooth function $H : X \longrightarrow \mathbb{R}$, interpreted as the energy observable, is singled out and called *the* Hamiltonian. Its corresponding Hamiltonian vector field is then interpreted as giving the infinitesimal time evolution of the system, and this is where Hamilton’s equations in def. 1.2.217 originate.

Definition 1.2.224. Given a phase space with Hamiltonian $((X, \omega), H)$, then any other classical $O \in C^\infty(X)$, it is called an *infinitesimal symmetry* of $((X, \omega), H)$ if the Hamiltonian vector field v_O of O preserves not just the symplectic form (as it automatically does by prop. 1.2.219) but also the given Hamiltonian, in that $\iota_{v_O} \mathbf{d}H = 0$.

Proposition 1.2.225 (symplectic Noether theorem). *If a Hamiltonian vector field v_O is an infinitesimal symmetry of a phase space (X, ω) with time evolution H according to def. 1.2.224, then the corresponding Hamiltonian function $O \in C^\infty(X)$ is a conserved quantity along the time evolution, in that*

$$\iota_{v_H} \mathbf{d}O = 0.$$

Conversely, if a function $O \in C^\infty(X)$ is preserved by the time evolution of a Hamiltonian H in this way, then its Hamiltonian vector field v_O is an infinitesimal symmetry of $((X, \omega), H)$.

Proof. This is immediate from the definition 1.2.217:

$$\begin{aligned} \iota_{v_H} \mathbf{d}O &= \iota_{v_H} \iota_{v_O} \omega \\ &= -\iota_{v_O} \iota_{v_H} \omega. \\ &= \iota_{v_O} \mathbf{d}H \end{aligned}$$

□

Remark 1.2.226. The utter simplicity of the proof of prop. 1.2.225 is to be taken as a sign of the power of the symplectic formalism in the formalization of physics, not as a sign that the statement itself is shallow. On the contrary, under a Legendre transform and passage from “Hamiltonian mechanics” to “Lagrangian mechanics” that we come to below in 1.2.10.11, the identification of symmetries with preserved observables in prop. 1.2.10.11 becomes the seminal *first Noether theorem*. See for instance [But06] for a review of the Lagrangian Noether theorem and its symplectic version in the context of classical mechanics. Below in 1.2.11.2 we observe that the same holds true also in the full context of classical field theory, if only one refines Hamiltonian mechanics to its localization by Hamilton-de Donder-Weyl field theory. The full *n-plectic Noether theorem* (for all field theory dimensions n) is prop. 1.2.296 below.

In the next section we pass from infinitesimal Hamiltonian flows to their finite version, the Hamiltonian symplectomorphism.

1.2.10.6 Hamiltonian (time evolution) trajectories and Hamiltonian correspondences We have seen so far transformations of phase space given by “canonical transformations”, hence symplectomorphisms. Of central importance in physics are of course those transformations that are part of a smooth evolution group, notably for time evolution. These are the “canonical transformations” coming from a generating function, hence the symplectomorphisms which come from a Hamiltonian function (the energy function, for time evolution), the *Hamiltonian symplectomorphisms*. Below in 1.2.10.10 we see that this notion is implied by prequantizing Lagrangian correspondences, but here it is good to recall the traditional definition.

Definition 1.2.227. The flow of a Hamiltonian vector field is called the corresponding *Hamiltonian flow*.

Notice that by prop. 1.2.219 we have

Proposition 1.2.228. *Every Hamiltonian flow is a symplectomorphism.*

Those symplectomorphisms arising this way are called the *Hamiltonian symplectomorphisms*. Notice that the Hamiltonian symplectomorphism depends on the Hamiltonian only up to addition of a locally constant function.

Using the Poisson bracket $\{-, -\}$ induced by the symplectic form ω , identifying the derivation $\{H, -\} : C^\infty(X) \rightarrow C^\infty(X)$ with the corresponding Hamiltonian vector field v by remark 1.2.223 and the exponent notation $\exp(t\{H, -\})$ with the Hamiltonian flow for parameter “time” $t \in \mathbb{R}$, we may write these Hamiltonian symplectomorphisms as

$$\exp(t\{H, -\}) : (X, \omega) \rightarrow (X, \omega).$$

It then makes sense to say that

Definition 1.2.229. A Lagrangian correspondence, def. 1.2.212, which is induced from a Hamiltonian symplectomorphism is a *Hamiltonian correspondences*

$$\left(\begin{array}{ccc} & \text{graph}(\exp(t\{H, -\})) & \\ i_1 \swarrow & & \searrow i_2 \\ X & & X \end{array} \right) \simeq \left(\begin{array}{ccc} & X & \\ = \swarrow & & \searrow \exp(t\{H, -\}) \\ X & & X \end{array} \right).$$

Remark 1.2.230. The smooth correspondence space of a Hamiltonian correspondence is naturally identified with the space of *classical trajectories*

$$\text{Fields}_{\text{traj}}^{\text{class}}(t) := \text{graph}(\exp(t)\{H, -\})$$

in that

1. every point in the space corresponds uniquely to a trajectory of parameter time length t characterized as satisfying the equations of motion as given by Hamilton's equations for H ;
2. the two projection maps to X send a trajectory to its initial and to its final configuration, respectively.

group structure is

Remark 1.2.231. By construction, Hamiltonian flows form a 1-parameter Lie group. By prop. 1.2.213 this group structure is preserved by the composition of the induced Hamiltonian correspondences.

It is useful to highlight this formally as follows.

Definition 1.2.232. Write $\text{Bord}_1^{\text{Riem}}$ for the category of 1-dimensional cobordisms equipped with Riemannian structure (hence with a real, non-negative length which is additive under composition), regarded as a symmetric monoidal category under disjoint union of cobordisms.

Then:

Proposition 1.2.233. *The Hamiltonian correspondences induced by a Hamiltonian function $H : X \rightarrow \mathbb{R}$ are equivalently encoded in a smooth monoidal functor of the form*

$$\exp((-)\{H, -\}) : \text{Bord}_1^{\text{Riem}} \rightarrow \text{Corr}_1(\mathbf{H}/\Omega^2),$$

where on the right we use the monoidal structure on correspondence of prop. 1.2.215.

Below the general discussion of prequantum field theory, such monoidal functors from cobordisms to correspondences of spaces of field configurations serve as the fundamental means of axiomatization. Whenever one is faced with such a functor, it is of particular interest to consider its value on *closed* cobordisms. Here in the 1-dimensional case this is the circle, and the value of such a functor on the circle would be called its (pre-quantum) *partition function*.

Proposition 1.2.234. *Given a phase space symplectic manifold (X, ω) and a Hamiltonian $H : X \rightarrow \mathbb{R}$, then the prequantum evolution functor of prop. 1.2.233 sends the circle of circumference t , regarded as a cobordism from the empty 0-manifold to itself*

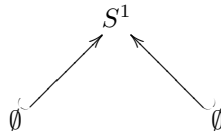

and equipped with the constant Riemannian metric of 1-volume t , to the correspondence

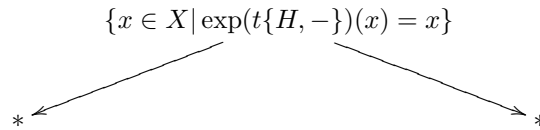

which is the smooth space of H -Hamiltonian trajectories of (time) length t that are closed, hence that come back to their initial value, regarded canonically as a correspondence from the point to itself.

Proof. We can decompose the circle of length t as the composition of

1. The coevaluation map on the point, regarded as a dualizable object $\text{Bord}_1^{\text{Riem}}$;
2. the interval of length t ;
3. the evaluation map on the point.

The monoidal functor accordingly takes this to the composition of correspondences of

1. the coevaluation map on X , regarded as a dualizable object in $\text{Corr}(\mathbf{H})$;
2. the Hamiltonian correspondence induced by $\exp(t\{H, -\})$;
3. the evaluation map on X .

As a diagram in \mathbf{H} , this is the following:

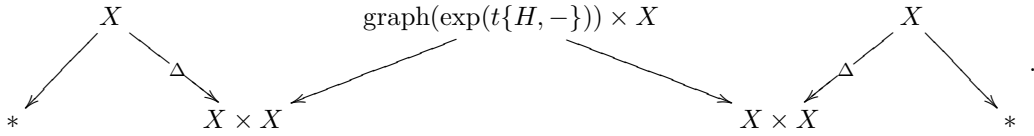

By the definition of composition in $\text{Corr}(\mathbf{H})$, the resulting composite correspondence space is the joint fiber product in \mathbf{H} over these maps. This is essentially verbatim the diagrammatic definition of the space of closed trajectories of parameter length t . \square

1.2.10.7 Noether symmetries and equivariant structure So far we have considered smooth spaces equipped with differential forms, and correspondences between these. To find genuine classical mechanics and in particular find the notion of prequantization, we need to bring the notion of *gauge symmetry* into the picture. We introduce here symmetries in classical field theory following Noether’s seminal analysis and then point out the crucial notion of *equivariance* of symplectic potentials necessary to give this global meaning. Below in 1.2.10.8 we see how building the *reduced phase space* by taking the symmetries into account makes the first little bit of “higher differential geometry” appear in classical field theory.

Definition 1.2.235. Given a local Lagrangian as in example 1.2.190 A *symmetry* of L is a vector field $v \in \Gamma(TPX)$ such that $\iota_v \delta L = 0$. It is called a *Hamiltonian symmetry* if restricted to phase space v is a Hamiltonian vector field, in that the contraction $\iota_v \omega$ is exact.

By definition of θ and EL in example 1.2.190, it follows that for v a symmetry, the 0-form

$$J_v := \iota_v \theta$$

is closed with respect to the time differential

$$\mathbf{d}_t J_v = 0.$$

Definition 1.2.236. The function J_v induced by a symmetry v is called the *conserved Noether charge* of v .

Example 1.2.237. For $Y = \mathbb{R}$ and $L = \frac{1}{2} \dot{\gamma}^2 \mathbf{d}t$ the vector field v tangent to the flow $\gamma \mapsto \gamma((-) + a)$ is a symmetry. This is such that $\iota_v \delta \gamma = \dot{\gamma}$. Hence the conserved quantity is $E := J_v = \dot{\gamma}^2$, the energy of the system. It is also a Hamiltonian symmetry.

Let then G be the group of Hamiltonian symmetries acting on $(\{EL = 0\}, \omega = \delta\theta)$. Write $\mathfrak{g} = \text{Lie}(G)$ for the Lie algebra of the Lie group. Given $v \in \mathfrak{g} = \text{Lie}(G)$ identify it with the corresponding Hamiltonian vector field. Then it follows that the Lie derivative of θ is exact, hence that for every v one can find an h such that

$$\mathcal{L}_v\theta = \mathbf{d}h.$$

The choice of h here is a choice of identification that relates the phase space potential θ to itself under a different but equivalent perspective of what the phase space points are. Such choices of “gauge equivalences” are necessary in order to give the (pre-)symplectic form on the unreduced phase space an physical meaning in view of the symmetries of the system. Moreover, what is really necessary for this is a coherent choice of such gauge equivalences also for the “global” or “large” gauge transformations that may not be reached by exponentiating Lie algebra elements of the symmetry group G . Such a coherent choice of gauge equivalences on θ reflecting the symmetry of the physical system is mathematically called a G -equivariant structure.

Definition 1.2.238. Given a smooth space X equipped with the action $\rho : X \times G \rightarrow X$ of a smooth group, and given a differential 1-form $\theta \in \Omega^1(X)$, and finally given a discrete subgroup $\Gamma \hookrightarrow \mathbb{R}$, then a G -equivariant structure on θ regarded as a (\mathbb{R}/Γ) -principal connection is

- for each $g \in G$ an equivalence

$$\eta_g : \theta \xrightarrow{\simeq} \rho(g)^*\theta$$

between θ and the pullback of θ along the action of g , hence a smooth function $\eta_g \in C^\infty(X, \mathbb{R}/\Gamma)$ with

$$\rho(g)^*\theta - \theta = \mathbf{d}\eta_g$$

such that

1. the assignment $g \mapsto \eta_g$ is smooth;
2. for all pairs $(g_1, g_2) \in G \times G$ there is an equality

$$\eta_{g_2}\eta_{g_1} = \eta_{g_2g_1}.$$

Remark 1.2.239. Notice that the condition $\rho(g)^*\theta - \theta = \mathbf{d}\eta_g$ depends on η_g only modulo elements in the discrete group $\Gamma \hookrightarrow \mathbb{R}$, while the second condition $\eta_{g_2}\eta_{g_1} = \eta_{g_2g_1}$ crucially depends on the actual representatives in $C^\infty(X, \mathbb{R}/\Gamma)$. For Γ the trivial group there is no difference, but in general it is unlikely that in this case the second condition may be satisfied. The second condition can in general only be satisfied modulo some subgroup of \mathbb{R} . Essentially the only such which yields a regular quotient is $\mathbb{Z} \hookrightarrow \mathbb{R}$ (or any non-zero rescaling of this), in which case

$$\mathbb{R}/\mathbb{Z} \simeq U(1)$$

is the circle group. This is the origin of the central role of *circle principal bundles* in field theory (“prequantum bundles”), to which we come below in 1.2.10.9.

The point of G -equivariant structure is that it makes the (pre-)symplectic potential θ “descend” to the quotient of X by G (the “correct quotient”, in fact), which is the *reduced phase space*. To say precisely what this means, we now introduce the concept of smooth groupoids in 1.2.10.8.

Remark 1.2.240. This equivariance on local Lagrangian is one of the motivations for refining the discussion here to *local prequantum field theory* in [Sc13b]: By remark 1.2.193 for a genuine n -dimensional field theory, the Lagrangian 1-form L above is the transgression of an n -form Lagrangian on a moduli space of fields. In local prequantum field theory we impose an equivariant structure already on this de-transgressed n -form Lagrangian such that under transgression it then induces equivariant structures in codimension 1, and hence consistent phase spaces, in fact consistent prequantized phase spaces.

1.2.10.8 Gauge theory, smooth groupoids and higher toposes As we mentioned in 1.1.1 *gauge principle* is a deep principle of modern physics, which says that in general two configurations of a physical system may be nominally different and still be identified by a *gauge equivalence* between them. In homotopy type theory precisely this principle is what is captured by *intensional identity types* (see remark 2.1.5). One class of example of such gauge equivalences in physics are the Noether symmetries induced by local Lagrangians which we considered above in 1.2.10.7. Gauge equivalences can be composed (and associatively so) and can be inverted. All physical statements respect this gauge equivalence, but it is wrong to identify gauge equivalent field configurations and pass to their sets of equivalence classes, as some properties depend on non-trivial auto-gauge transformations.

In mathematical terms what this says is precisely that field configurations and gauge transformations between them form what is called a *groupoid* or *homotopy 1-type*.

Definition 1.2.241. A *groupoid* \mathcal{G}_\bullet is a set \mathcal{G}_0 – to be called its set of *objects* or *configurations* – and a set $\mathcal{G}_1 = \left\{ \left(x_1 \xrightarrow{f} x_2 \right) \mid x_1, x_2 \in \mathcal{G}_0 \right\}$ – to be called the set of *morphisms* or *gauge transformations* – between these objects, together with a partial composition operation of morphisms over common objects

$$f_2 \circ f_1 : x_1 \xrightarrow{f_1} x_2 \xrightarrow{f_2} x_3$$

which is associative, and for which every object has a unit (the identity morphism $\text{id}_x : x \rightarrow x$) and such that every morphism has an inverse.

The two extreme examples are:

Example 1.2.242. For X any set, it becomes a groupoid by considering for each object an identity morphism and no other morphisms.

Example 1.2.243. For G a group, there is a groupoid which we denote $\mathbf{B}G$ defined to have a single object $*$, one morphism from that object to itself for each element of the group

$$(\mathbf{B}G)_1 = \left\{ * \xrightarrow{g} * \mid g \in G \right\}$$

and where composition is given by the product operation in G .

The combination of these two examples which is of central interest here is the following.

Example 1.2.244. For X a set and G a group with an action $\rho : X \times G \rightarrow X$ on X , the corresponding *action groupoid* or *homotopy quotient*, denoted $X//G$, is the groupoid whose objects are the elements of X , and whose morphisms are of the form

$$x_1 \xrightarrow{g} (x_2 = \rho(g)(x_1))$$

with composition given by the composition in G .

Remark 1.2.245. The homotopy quotient is a refinement of the actual quotient X/G in which those elements of X which are related by the G -action are actually *identified*. In contrast to that, the homotopy quotient makes element which are related by the action of the “gauge” group G be *equivalent without being equal*. Moreover it remembers *how* two elements are equivalent, hence which “gauge transformation” relates them. This is most striking in example 1.2.243, which is in fact the special case of the homotopy quotient construction for the case that G acts on a single element:

$$\mathbf{B}G \simeq *//G.$$

Therefore given an unreduced phase space X as in 1.2.10.1 and equipped with an action of a gauge symmetry group as in 1.2.10.7, then the corresponding *reduced phase space* should be the homotopy quotient $X//G$, hence the space of fields with gauge equivalences between them. But crucially for physics, this is not just a discrete set of points with a discrete set of morphisms between them, as in the above definition, but in addition to the information about field configurations and gauge equivalences between them carries a *smooth structure*.

We therefore need a definition of *smooth groupoids*, hence of homotopy types which carry *differential geometric* structure. Luckily, the definition in 1.2.10.2 of smooth spaces immediately generalizes to an analogous definition of smooth groupoids.

First we need the following obvious notion.

Definition 1.2.246. Given two groupoids \mathcal{G}_\bullet and \mathcal{K}_\bullet , a homomorphism $F_\bullet : \mathcal{G}_\bullet \rightarrow \mathcal{K}_\bullet$ between them (called a *functor*) is a function $F_1 : \mathcal{G}_1 \rightarrow \mathcal{K}_1$ between the sets of morphisms such that identity-morphisms are sent to identity morphisms and such that composition is respected.

Groupoids themselves are subject to a notion of gauge equivalence:

Definition 1.2.247. A functor F_\bullet is called an *equivalence of groupoids* if its image hits every equivalence class of objects in \mathcal{K}_\bullet and if for all $x_1, x_2 \in \mathcal{G}_0$ the map F_1 restricts to a bijection between the morphisms from x_1 to x_2 in \mathcal{G}_\bullet and the morphisms between $F_0(x_1)$ and $F_0(x_2)$ in \mathcal{K}_\bullet .

With that notion we can express coordinate transformations between smooth groupoids and arrive at the following generalization of def. 1.2.194.

Definition 1.2.248. A *smooth groupoid* or *smooth homotopy 1-type* X_\bullet is

1. an assignment to each $n \in \mathbb{N}$ of a groupoid, to be written $X_\bullet(\mathbb{R}^n)$ and to be called the *groupoid of smooth maps from \mathbb{R}^n into X and gauge transformations between these*,
2. an assignment to each ordinary smooth function $f : \mathbb{R}^{n_1} \rightarrow \mathbb{R}^{n_2}$ between Cartesian spaces of a functor of groupoids $X(f) : X_\bullet(\mathbb{R}^{n_2}) \rightarrow X_\bullet(\mathbb{R}^{n_1})$, to be called the *pullback of smooth functions into X along f* ;

such that both the components X_0 and X_1 form a smooth space according to def 1.2.194.

With this definition in hand we can now form the reduced phase space in a way that reflects both its smooth structure as well as its gauge-theoretic structure:

Example 1.2.249. Given a smooth space X and a smooth group G with a smooth action $\rho : X \times G \rightarrow X$, then the *smooth homotopy quotient* of this action is the smooth groupoid, def. 1.2.248. which on each coordinate chart is the homotopy quotient, def. 5.2.1, of the coordinates of G acting on the coordinates of X , hence the assignment

$$X//G : \mathbb{R}^n \mapsto (X(\mathbb{R}^n)) // (G(\mathbb{R}^n)) .$$

Remark 1.2.250. In most of the physics literature only the infinitesimal approximation to the smooth homotopy quotient $X//G$ is considered, that however is famous: it is the *BRST complex* of gauge theory [HeTe92]. More in detail, to any Lie group G is associated a Lie algebra \mathfrak{g} , which is its “infinitesimal approximation” in that it consists of the first order neighbourhood of the neutral element in G , equipped with the first linearized group structure, incarnated as the Lie bracket. In direct analogy to this, a smooth groupoid such as $X//G$ has an infinitesimal approximation given by a *Lie algebroid*, a vector bundle on X whose fibers form the first order neighbourhood of the smooth space of morphisms at the identity morphisms. Moreover, Lie algebroids can equivalently be encoded dually by the algebras of functions on these first order neighbourhoods. These are differential graded-commutative algebras and the dgc-algebra associated this way to the smooth groupoid $X//G$ is what in the physics literature is known as the BRST complex.

To correctly capture the interplay between the differential geometric structure and the homotopy theoretic structure in this definition we have to in addition declare the following

Definition 1.2.251. A homomorphism $f_\bullet : X_\bullet \rightarrow Y_\bullet$ of smooth groupoids is called a *local equivalence* if it is a *stalkwise* equivalence of groupoids, hence if for each Cartesian space \mathbb{R}^n and for each point $x \in \mathbb{R}^n$, there is an open neighbourhood $\mathbb{R}^n \simeq U_x \hookrightarrow \mathbb{R}^n$ such that F_\bullet restricted to this open neighbourhood is an equivalence of groupoids according to def. 1.2.247.

Definition 1.2.252. The $(2, 1)$ -*topos of smooth groupoids* is the homotopy theory obtained from the category $\text{Sh}(\text{CartSp}, \text{Grpd})$ of smooth groupoids by universally turning the local equivalences into actual equivalences, def. ??.

This refines the construction of the topos of smooth spaces from before, and hence we find it convenient to use the same symbol for it:

$$\mathbf{H} := \text{Sh}(\text{CartSp}, \text{Grpd})[\{\text{local equivalences}\}^{-1}].$$

1.2.10.9 The kinetic action, pre-quantization and differential cohomology The refinement of gauge transformations of differential 1-forms to coherent $U(1)$ -valued functions which we have seen in the construction of the reduced phase space above in 1.2.10.7 also appears in physics from another angle, which is not explicitly gauge theoretic, but related to the global definition of the exponentiated action functional.

Given a pre-symplectic form $\omega \in \Omega_{\text{cl}}^2(X)$, by the Poincaré lemma there is a good cover $\{U_i \hookrightarrow X\}_i$ and smooth 1-forms $\theta_i \in \Omega^1(U_i)$ such that $\mathbf{d}\theta_i = \omega|_{U_i}$. Physically such a 1-form is (up to a factor of 2) a choice of *kinetic energy density* called a *kinetic Lagrangian* L_{kin} :

$$\theta_i = 2L_{\text{kin},i}.$$

Example 1.2.253. Consider the phase space $(\mathbb{R}^2, \omega = \mathbf{d}q \wedge \mathbf{d}p)$ of example 1.2.189. Since \mathbb{R}^2 is a contractible topological space we consider the trivial covering $(\mathbb{R}^2 \text{ covering itself})$ since this is already a good covering in this case. Then all the $\{g_{ij}\}$ are trivial and the data of a prequantization consists simply of a choice of 1-form $\theta \in \Omega^1(\mathbb{R}^2)$ such that

$$\mathbf{d}\theta = \mathbf{d}q \wedge \mathbf{d}p.$$

A standard such choice is

$$\theta = -p \wedge \mathbf{d}q.$$

Then given a trajectory $\gamma: [0, 1] \rightarrow X$ which satisfies Hamilton's equation for a standard kinetic energy term, then $(p\mathbf{d}q)(\dot{\gamma})$ is this kinetic energy of the particle which traces out this trajectory.

Given a path $\gamma: [0, 1] \rightarrow X$ in phase space, its *kinetic action* S_{kin} is supposed to be the integral of \mathcal{L}_{kin} along this trajectory. In order to make sense of this in generality with the above locally defined kinetic Lagrangians $\{\theta_i\}_i$, there are to be transition functions $g_{ij} \in C^\infty(U_i \cap U_j, \mathbb{R})$ such that

$$\theta_j|_{U_j} - \theta_i|_{U_i} = \mathbf{d}g_{ij}.$$

If on triple intersections these functions satisfy

$$g_{ij} + g_{jk} = g_{ik} \quad \text{on } U_i \cap U_j \cap U_k$$

then there is a well defined action functional

$$S_{\text{kin}}(\gamma) \in \mathbb{R}$$

obtained by dividing γ into small pieces that each map to a single patch U_i , integrating θ_i along this piece, and adding the contribution of g_{ij} at the point where one switches from using θ_i to using θ_j .

However, requiring this condition on triple overlaps as an equation between \mathbb{R} -valued functions makes the local patch structure trivial: if this holds then one can find a single $\theta \in \Omega^1(X)$ and functions $h_i \in C^\infty(U_i, \mathbb{R})$ such that superficially pleasant effect that the action is $\theta_i = \theta|_{U_i} + \mathbf{d}h_i$. This has the simply the integral against this globally defined 1-form, $S_{\text{kin}} = \int_{[0,1]} \gamma^* L_{\text{kin}}$, but it also means that the pre-symplectic form ω is exact, which is not the case in many important examples.

On the other hand, what really matters in physics is not the action functional $S_{\text{kin}} \in \mathbb{R}$ itself, but the *exponentiated* action

$$\exp\left(\frac{i}{\hbar}S\right) \in \mathbb{R}/(2\pi\hbar)\mathbb{Z}.$$

For this to be well defined, one only needs that the equation $g_{ij} + g_{jk} = g_{ik}$ holds modulo addition of an integral multiple of $h = 2\pi\hbar$, which is *Planck's constant*, def. 4.4.128. If this is the case, then one says that the data $(\{\theta_i\}, \{g_{ij}\})$ defines equivalently

- a $U(1)$ -principal connection;
- a degree-2 cocycle in ordinary differential cohomology

on X , with *curvature* the given symplectic 2-form ω .

Such data is called a *pre-quantization* of the symplectic manifold (X, ω) . Since it is the exponentiated action functional $\exp(\frac{i}{\hbar}S)$ that enters the quantization of the given mechanical system (for instance as the integrand of a path integral), the prequantization of a symplectic manifold is indeed precisely the data necessary before quantization.

Therefore, in the spirit of the above discussion of pre-symplectic structures, we would like to refine the smooth moduli space of closed differential 2-forms to a moduli space of prequantized differential 2-forms.

Again this does naturally exist if only we allow for a good notion of “space”. An additional phenomenon to be taken care of now is that while pre-symplectic forms are either equal or not, their pre-quantizations can be different and yet be *equivalent*:

because there is still a remaining freedom to change this data without changing the exponentiated action along a *closed* path: we say that a choice of functions $h_i \in C^\infty(U_i, \mathbb{R}/(2\pi\hbar)\mathbb{Z})$ defines an equivalence between $(\{\theta_i\}, \{g_{ij}\})$ and $(\{\tilde{\theta}_i\}, \{\tilde{g}_{ij}\})$ if $\tilde{\theta}_i - \theta_i = \mathbf{d}h_i$ and $\tilde{g}_{ij} - g_{ij} = h_j - h_i$.

This means that the space of prequantizations of (X, ω) is similar to an *orbifold*: it has points which are connected by gauge equivalences: there is a *groupoid* of pre-quantum structures on a manifold X . Otherwise this space of prequantizations is similar to the spaces Ω_{cl}^2 of differential forms, in that for each smooth manifold there is a collection of smooth such data and it may consistently be pullback back along smooth functions of smooth manifolds.

As before for the pre-symplectic differential forms in 1.2.10.2 it will be useful to find a moduli space for such prequantum structures. This certainly cannot exist as a smooth manifold, but due to the gauge transformations between prequantizations it can also not exist as a more general smooth space. However, it does exist as a *smooth groupoid*, def. 1.2.252.

Definition 1.2.254. For $X = \mathbb{R}^n$ a Cartesian space, write $\Omega^1(X)$ for the set of smooth differential 1-forms on X and write $C^\infty(X, U(1))$ for the set of smooth circle-group valued function on X . There is an action

$$\rho : C^\infty(X, U(1)) \times \Omega^1(\mathbb{R}^n) \longrightarrow \Omega^1(X, U(1))$$

of functions on 1-forms A by gauge transformation g , given by the formula

$$\rho(g)(A) := A + \mathbf{d}\log g.$$

Hence if $g = \exp(i\kappa)$ is given by the exponential of a smooth real valued function (which is always the case on \mathbb{R}^n) then this is

$$\rho(g)(A) := A + \mathbf{d}\kappa.$$

Definition 1.2.255. Write

$$\mathbf{BU}(1)_{\text{conn}} \in \mathbf{H},$$

for the smooth groupoid, def. 1.2.248, which for Cartesian space \mathbb{R}^n has as groupoid of coordinate charts the homotopy quotient, def. 5.2.1, of the smooth functions on the coordinate chart acting on the smooth 1-forms on the coordinate chart.

$$\mathbf{BU}(1)_{\text{conn}} : \mathbb{R}^n \mapsto \Omega^1(\mathbb{R}) // \mathbb{C}^\infty(\mathbb{R}^n, U(1)).$$

Equivalently this is the smooth homotopy quotient, def. 1.2.249, of the smooth group $U(1) \in \mathbf{H}$ acting on the universal smooth moduli space Ω^1 of smooth differential 1-forms:

$$\mathbf{BU}(1)_{\text{conn}} \simeq \Omega^1 // U(1).$$

We call this the *universal moduli stack of prequantizations* or *universal moduli stack of $U(1)$ -principal connections*.

Remark 1.2.256. This smooth groupoid $\mathbf{BU}(1)_{\text{conn}} \simeq \Omega^1 // U(1)$ is equivalently characterized by the following properties.

1. For X any smooth manifold, smooth functions

$$X \longrightarrow \mathbf{BU}(1)_{\text{conn}}$$

are equivalent to prequantum structures $(\{\theta_i\}, \{g_{ij}\})$ on X ,

2. a homotopy

$$X \begin{array}{c} \curvearrowright \\ \Downarrow \mathbf{BU}(1)_{\text{conn}} \\ \curvearrowleft \end{array}$$

between two such maps is equivalently a gauge transformation $(\{h_i\})$ between these prequantizations.

Proposition 1.2.257. *There is then in \mathbf{H} a morphism*

$$F : \mathbf{BU}(1)_{\text{conn}} \longrightarrow \Omega_{\text{cl}}^2$$

from this universal moduli stack of prequantizations back to the universal smooth moduli space of closed differential 2-form. This is the universal curvature map in that for $\nabla : X \longrightarrow \mathbf{BU}(1)_{\text{conn}}$ a prequantization datum $(\{\theta_i\}, \{g_{ij}\})$, the composite

$$F_{(-)} : X \xrightarrow{\nabla} \mathbf{BU}(1)_{\text{conn}} \xrightarrow{F_{(-)}} \Omega_{\text{cl}}^2$$

is the closed differential 2-form on X characterized by $\omega|_{U_i} = \mathbf{d}\theta_i$, for every patch U_i . Again, this property characterizes the map $F_{(-)}$ and may be taken as its definition.

Using this language of the $(2, 1)$ -topos \mathbf{H} of smooth groupoids, we may then formally capture the above discussion of prequantization as follows:

Definition 1.2.258. Given a symplectic manifold (X, ω) , regarded by prop. 1.2.204 as an object $(X \xrightarrow{\omega} \Omega_{\text{cl}}^2) \in \mathbf{H}/\Omega_{\text{cl}}^2$, then a *prequantization* of (X, ω) is a lift ∇ in the diagram

$$\begin{array}{ccc} X & \xrightarrow{\nabla} & \mathbf{BU}(1)_{\text{conn}} \\ & \searrow \omega & \downarrow F_{(-)} \\ & & \Omega_{\text{cl}}^2 \end{array}$$

in \mathbf{H} , hence is a lift of (X, ω) through the *base change* functor (see prop. 2.1.2 for this terminology) or *dependent sum* functor (see def. 2.1.3)

$$\sum_{F(-)} : \mathbf{H}/\mathbf{BU}(1)_{\text{conn}} \longrightarrow \mathbf{H}/\Omega_{\text{cl}}^2$$

that goes from the slice over the universal moduli stack of prequantizations to the slice over the universal smooth moduli space of closed differential 2-forms.

Moreover, in this language of geometric homotopy theory we then also find a conceptual re-statement of the descent of the (pre-)symplectic potential to the reduced phase space, from 1.2.10.7:

Proposition 1.2.259. *Given a covariant phase space X with (pre-)symplectic potential θ and gauge group action $\rho : G \times X \rightarrow X$, a G -equivariant structure on θ , def. 1.2.238, is equivalently an extension ∇_{red} of θ along the map to the smooth homotopy quotient $X//G$ as a (\mathbb{R}/Γ) -principal connection, hence a diagram in \mathbf{H} of the form*

$$\begin{array}{ccc} X & \xrightarrow{\theta} & \mathbf{BU}(1)_{\text{conn}} \\ \downarrow & \nearrow \nabla_{\text{red}} & \\ X//G & & \end{array}$$

1.2.10.10 The classical action, the Legendre transform and Hamiltonian flows The reason to consider Hamiltonian symplectomorphisms, prop. 1.2.228 instead of general symplectomorphisms, is really because these give homomorphisms not just between plain symplectic manifolds, but between their prequantizations, def. 1.2.258. To these we turn now.

Consider a morphism

$$\begin{array}{ccc} X & \xrightarrow{\phi} & X \\ \searrow \nabla & \swarrow \nabla & \\ & \mathbf{BU}(1)_{\text{conn}} & \end{array},$$

hence a morphism in the slice topos $\mathbf{H}/\mathbf{BU}(1)_{\text{conn}}$. This has been discussed in detail in [FRS13a].

One finds that infinitesimally such morphisms are given by a Hamiltonian and its Legendre transform.

Proposition 1.2.260. *Consider the phase space $(\mathbb{R}^2, \omega = \mathbf{d}\mathbf{q} \wedge \mathbf{d}\mathbf{p})$ of example 1.2.189 equipped with its canonical prequantization by $\theta = \mathbf{p}\mathbf{d}\mathbf{q}$ from example 1.2.253. Then for $H : \mathbb{R}^2 \rightarrow \mathbb{R}$ a Hamiltonian, and for $t \in \mathbb{R}$ a parameter ("time"), a lift of the Hamiltonian symplectomorphism $\exp(t\{H, -\})$ from \mathbf{H} to the slice topos $\mathbf{H}/\mathbf{BU}(1)_{\text{conn}}$ is given by*

$$\begin{array}{ccc} X & \xrightarrow{\exp(t\{H, -\})} & X \\ \searrow \theta & \swarrow \theta & \\ & \mathbf{BU}(1)_{\text{conn}} & \end{array},$$

where

- $S_t : \mathbb{R}^2 \rightarrow \mathbb{R}$ is the action functional of the classical trajectories induced by H ,
- which is the integral $S_t = \int_0^t L dt$ of the Lagrangian $L dt$ induced by H ,
- which is the Legendre transform

$$L := p \frac{\partial H}{\partial p} - H : \mathbb{R}^2 \rightarrow \mathbb{R}.$$

In particular, this induces a functor

$$\exp(iS) : \text{Bord}_1^{\text{Riem}} \longrightarrow \mathbf{H}/\mathbf{BU}(1)_{\text{conn}} .$$

Conversely, a symplectomorphism, being a morphism in \mathbf{H}/Ω_{cl}^2 is a Hamiltonian symplectomorphism precisely if it admits such a lift to $\mathbf{H}/\mathbf{BU}(1)_{\text{conn}}$.

This is a special case of the discussion in [FRS13a]. Proof. The canonical prequantization of $(\mathbb{R}^2, \mathbf{d}q \wedge \mathbf{d}p)$ is the globally defined connection on a bundle—connection 1-form

$$\theta := p \mathbf{d}q .$$

We have to check that on $\text{graph}(\exp(t\{H, -\}))$ we have the equation

$$p_2 \wedge \mathbf{d}q_2 = p_1 \wedge \mathbf{d}q_1 + \mathbf{d}S .$$

Or rather, given the setup, it is more natural to change notation to

$$p_t \wedge \mathbf{d}q_t = p \wedge \mathbf{d}q + \mathbf{d}S .$$

Notice here that by the nature of $\text{graph}(\exp(t\{H, -\}))$ we can identify

$$\text{graph}(\exp(t\{H, -\})) \simeq \mathbb{R}^2$$

and under this identification

$$q_t = \exp(t\{H, -\})q$$

and

$$p_t = \exp(t\{H, -\})p .$$

It is sufficient to check the claim infinitesimal object—infinitesimally. So let $t = \epsilon$ be an infinitesimal, hence such that $\epsilon^2 = 0$. Then the above is Hamilton's equations and reads equivalently

$$q_\epsilon = q + \frac{\partial H}{\partial p} \epsilon$$

and

$$p_\epsilon = p - \frac{\partial H}{\partial q} \epsilon .$$

Using this we compute

$$\begin{aligned} \theta_\epsilon - \theta &= p_\epsilon \wedge \mathbf{d}q_\epsilon - p \wedge \mathbf{d}q \\ &= \left(p - \frac{\partial H}{\partial q} \epsilon \right) \wedge \mathbf{d} \left(q + \frac{\partial H}{\partial p} \epsilon \right) - p \wedge \mathbf{d}q \\ &= \epsilon \left(p \wedge \mathbf{d} \frac{\partial H}{\partial p} - \frac{\partial H}{\partial q} \wedge \mathbf{d}q \right) \\ &= \epsilon \left(\mathbf{d} \left(p \frac{\partial H}{\partial p} \right) - \frac{\partial H}{\partial p} \wedge \mathbf{d}p - \frac{\partial H}{\partial q} \wedge \mathbf{d}q \right) \\ &= \epsilon \mathbf{d} \left(p \frac{\partial H}{\partial p} - H \right) \end{aligned}$$

□

Remark 1.2.261. When one speaks of symplectomorphisms as “canonical transformations” (see e.g. [Ar89], p. 206), then the function S in prop. 1.2.260 is also known as the “generating function of the canonical transformation”, see [Ar89], chapter 48.

Remark 1.2.262. Proposition 1.2.260 says that the slice topos $\mathbf{H}/\mathbf{B}U(1)_{\text{conn}}$ unifies classical mechanics in its two incarnations as Hamiltonian mechanics and as Lagrangian mechanics. A morphism here is a diagram in \mathbf{H} of the form

$$\begin{array}{ccc} X & \xrightarrow{\quad} & Y \\ & \searrow & \swarrow \\ & \mathbf{B}U(1)_{\text{conn}} & \end{array}$$

and which may be regarded as having two components: the top horizontal 1-morphism as well as the homotopy/2-morphism filling the slice. Given a smooth flow of these, the horizontal morphism is the flow of a Hamiltonian vector field for some Hamiltonian function H , and the 2-morphism is a $U(1)$ -gauge transformation given (locally) by a $U(1)$ -valued function which is the exponentiated action functional that is the integral of the Lagrangian L which is the Legendre transform of H .

So in a sense the prequantization lift through the base change/dependent sum along the universal curvature map

$$\sum_{F(-)} : \mathbf{H}/\mathbf{B}U(1)_{\text{conn}} \longrightarrow \mathbf{H}/\Omega_{\text{cl}}^2$$

is the Legendre transform which connects Hamiltonian mechanics with Lagrangian mechanics.

1.2.10.11 The classical action functional pre-quantizes Lagrangian correspondences We may sum up these observations as follows.

Definition 1.2.263. Given a Lagrangian correspondence

$$\begin{array}{ccc} & \text{graph}(\phi) & \\ i_1 \swarrow & & \searrow i_2 \\ X_1 & & X_2 \\ \omega_1 \searrow & & \swarrow \omega_2 \\ & \Omega_{\text{cl}}^2 & \end{array}$$

as in prop. 1.2.210, a *prequantization* of it is a lift of this diagram in \mathbf{H} to a diagram of the form

$$\begin{array}{ccc} & \text{graph}(\phi) & \\ i_1 \swarrow & & \searrow i_2 \\ X_1 & & X_2 \\ \omega_1 \searrow & & \swarrow \omega_2 \\ & \mathbf{B}U(1)_{\text{conn}} & \\ & \downarrow F(-) & \\ & \Omega_{\text{cl}}^2 & \end{array}$$

Remark 1.2.264. This means that a prequantization of a Lagrangian correspondence is a prequantization of the source and target symplectic manifolds by prequantum circle bundles as in def. 1.2.258, together with a choice of (gauge) equivalence between the respective pullback of these two bundles to the correspondence space. More abstractly, such a prequantization is a lift through the base change/dependent sum map along

the universal curvature morphism

$$\text{Corr} \left(\sum_{F(-)} \right) : \text{Corr} (\mathbf{H}/\mathbf{BU}(1)_{\text{conn}}) \longrightarrow \text{Corr} (\mathbf{H}/\Omega_{\text{cl}}^2) .$$

From prop. 1.2.260 and under the equivalence of example 1.2.209 it follows that smooth 1-parameter groups of prequantized Lagrangian correspondences are equivalently Hamiltonian flows, and that the pre-quantization of the underlying Hamiltonian correspondences is given by the classical action functional.

In summary, the description of classical mechanics here identifies prequantized Lagrangian correspondences schematically as follows:

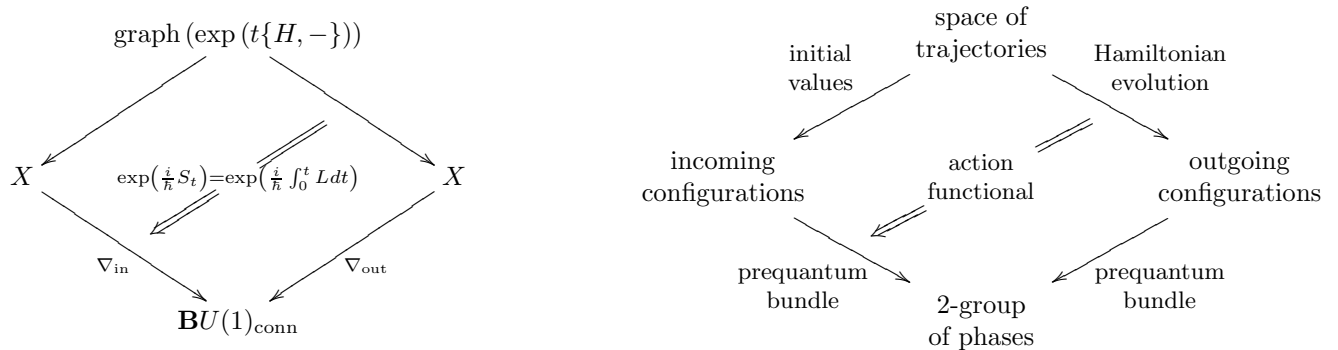

This picture of classical mechanics as the theory of correspondences in higher slices topos is what allows a seamless generalization to a local discussion of prequantum field theory in [Sc13b].

1.2.10.12 Quantization, the Heisenberg group, and slice automorphism groups While we do not discuss genuine quantization here (in a way adapted to the perspective here this is discussed in [Nui13]) it is worthwhile to notice that the perspective of classical mechanics by correspondences in slice toposes seamlessly leads over to *quantization* by recognizing that the slice automorphism groups of the prequantized phase spaces are nothing but the “quantomorphisms groups” containing the famous Heisenberg groups of quantum operators. This has been developed for higher prequantum field theory in [FRS13a], see 3.9.13.5 below. Here we give an exposition, which re-amplifies some of the structures already found above.

Quantization of course was and is motivated by experiment, hence by observation of the observable universe: it just so happens that quantum mechanics and quantum field theory correctly account for experimental observations where classical mechanics and classical field theory gives no answer or incorrect answers (see for instance [Di87]). A historically important example is the phenomenon called the “ultraviolet catastrophe”, a paradox predicted by classical statistical mechanics which is *not* observed in nature, and which is corrected by quantum mechanics.

But one may also ask, independently of experimental input, if there are good formal mathematical reasons and motivations to pass from classical mechanics to quantum mechanics. Could one have been led to quantum mechanics by just pondering the mathematical formalism of classical mechanics? (Hence more precisely: is there a natural “Synthetic quantum field theory” [Sc13d]).

The following spells out an argument to this effect.

So to briefly recall, a system of classical mechanics/prequantum field theory—prequantum mechanics is a phase space, formalized as a symplectic manifold (X, ω) . A symplectic manifold is in particular a Poisson manifold, which means that the algebra of functions on phase space X , hence the algebra of *classical observables*, is canonically equipped with a compatible Lie bracket: the *Poisson bracket*. This Lie bracket is what controls dynamics in classical mechanics. For instance if $H \in C^\infty(X)$ is the function on phase space which is interpreted as assigning to each configuration of the system its energy – the Hamiltonian function –

then the Poisson bracket with H yields the infinitesimal object—infinitesimal time evolution of the system: the differential equation famous as Hamilton’s equations.

Something to take notice of here is the *infinitesimal* nature of the Poisson bracket. Generally, whenever one has a Lie algebra \mathfrak{g} , then it is to be regarded as the infinitesimal object—infinitesimal approximation to a globally defined object, the corresponding Lie group (or generally smooth group) G . One also says that G is a *Lie integration* of \mathfrak{g} and that \mathfrak{g} is the Lie differentiation of G .

Therefore a natural question to ask is: *Since the observables in classical mechanics form a Lie algebra under Poisson bracket, what then is the corresponding Lie group?*

The answer to this is of course ”well known” in the literature, in the sense that there are relevant monographs which state the answer. But, maybe surprisingly, the answer to this question is not (at time of this writing) a widely advertized fact that has found its way into the basic educational textbooks. The answer is that this Lie group which integrates the Poisson bracket is the ”quantomorphism group”, an object that seamlessly leads to the quantum mechanics of the system.

Before we spell this out in more detail, we need a brief technical aside: of course Lie integration is not quite unique. There may be different global Lie group objects with the same Lie algebra.

The simplest example of this is already one of central importance for the issue of quantization, namely, the Lie integration of the abelian line Lie algebra \mathbb{R} . This has essentially two different Lie groups associated with it: the simply connected topological space—simply connected translation group, which is just \mathbb{R} itself again, equipped with its canonical additive abelian group structure, and the discrete space—discrete quotient of this by the group of integers, which is the circle group

$$U(1) = \mathbb{R}/\mathbb{Z}.$$

Notice that it is the discrete and hence ”quantized” nature of the integers that makes the real line become a circle here. This is not entirely a coincidence of terminology, but can be traced back to the heart of what is ”quantized” about quantum mechanics.

Namely, one finds that the Poisson bracket Lie algebra $\mathbf{poiss}(X, \omega)$ of the classical observables on phase space is (for X a connected topological space—connected manifold) a Lie algebra extension of the Lie algebra $\mathfrak{ham}(X)$ of Hamiltonian vector fields on X by the line Lie algebra:

$$\mathbb{R} \longrightarrow \mathbf{poiss}(X, \omega) \longrightarrow \mathfrak{ham}(X).$$

This means that under Lie integration the Poisson bracket turns into an central extension of the group of Hamiltonian symplectomorphisms of (X, ω) . And either it is the fairly trivial non-compact extension by \mathbb{R} , or it is the interesting central extension by the circle group $U(1)$. For this non-trivial Lie integration to exist, (X, ω) needs to satisfy a quantization condition which says that it admits a prequantum line bundle. If so, then this $U(1)$ -central extension of the group $\mathbf{Ham}(X, \omega)$ of Hamiltonian symplectomorphisms exists and is called... the ”quantomorphism group” $\mathbf{QuantMorph}(X, \omega)$:

$$U(1) \longrightarrow \mathbf{QuantMorph}(X, \omega) \longrightarrow \mathbf{HamSympl}(X, \omega).$$

More precisely, this group is just the slice automorphism group:

Proposition 1.2.265. *Let (X, ω) be a symplectic manifold with prequantization $\nabla : X \longrightarrow \mathbf{BU}(1)_{\text{conn}}$, according to def. 1.2.258, then the smooth automorphism group of ∇ regarded as an object in the higher slice topos $\mathbf{H}/\mathbf{BU}(1)_{\text{conn}}$ is the quantomorphism group $\mathbf{QuantMorph}(X, \omega)$*

$$\begin{aligned} \mathbf{QuantMorph}(X, \omega) &\simeq \mathbf{Aut}_{\mathbf{H}/\mathbf{BU}(1)_{\text{conn}}}(\nabla) \\ &\simeq \mathbf{Aut}_{\mathbf{Corr}(\mathbf{H}/\mathbf{BU}(1)_{\text{conn}})}(\nabla) \\ &\simeq \left\{ \begin{array}{ccc} X & \xrightarrow{\phi} & X \\ & \simeq & \\ & \xleftarrow{\quad} & \\ \nabla \searrow & & \swarrow \\ & \mathbf{BU}(1)_{\text{conn}} & \end{array} \right\} \end{aligned}$$

in that

1. The Lie algebra of $\text{QuantMorph}(X, \omega)$ is the Poisson bracket Lie algebra of (X, ω) ;
2. This group constitutes a $U(1)$ -central extension of the group of Hamiltonian symplectomorphisms.

While important, for some reason this group is not very well known, which is striking because it contains a small subgroup which is famous in quantum mechanics: the *Heisenberg group*.

More precisely, whenever (X, ω) itself has a Hamiltonian action—compatible group structure, notably if (X, ω) is just a symplectic vector space (regarded as a group under addition of vectors), then we may ask for the subgroup of the quantomorphism group which covers the (left) action of phase space (X, ω) on itself. This is the corresponding Heisenberg group $\text{Heis}(X, \omega)$, which in turn is a $U(1)$ -central extension of the group X itself:

$$U(1) \longrightarrow \text{Heis}(X, \omega) \longrightarrow X .$$

Proposition 1.2.266. *If (X, ω) is a symplectic manifold that at the same time is a group which acts on itself by Hamiltonian diffeomorphisms, then the Heisenberg group of (X, ω) is the pullback $\text{Heis}(X, \omega)$ of smooth groups in the following diagram in \mathbf{H}*

$$\begin{array}{ccc} \text{Heis}(X, \omega) & \longrightarrow & \text{QuantMorph}(X, \omega) \\ \downarrow & & \downarrow \\ X & \longrightarrow & \text{HamSymp}(X, \omega) \end{array} .$$

Remark 1.2.267. In other words this exhibits $\text{QuantMorph}(X, \omega)$ as a universal $U(1)$ -central extension characteristic of quantum mechanics from which various other $U(1)$ -extension in QM are obtained by pull-back/restriction. In particular all *classical anomalies* arise this way, discussed below in 1.2.10.14.

At this point it is worth pausing for a second to note how the hallmark of quantum mechanics has appeared as if out of nowhere simply by applying Lie integration to the Lie algebra—Lie algebraic structures in classical mechanics:

if we think of Lie integration—Lie integrating \mathbb{R} to the interesting circle group $U(1)$ instead of to the uninteresting translation group \mathbb{R} , then the name of its canonical basis element $1 \in \mathbb{R}$ is canonically " i ", the imaginary unit. Therefore one often writes the above central extension instead as follows:

$$i\mathbb{R} \longrightarrow \text{poiss}(X, \omega) \longrightarrow \text{ham}(X, \omega)$$

in order to amplify this. But now consider the simple special case where $(X, \omega) = (\mathbb{R}^2, dp \wedge dq)$ is the 2-dimensional symplectic vector space which is for instance the phase space of the particle propagating on the line. Then a canonical set of generators for the corresponding Poisson bracket Lie algebra consists of the linear functions p and q of classical mechanics textbook fame, together with the *constant* function. Under the above Lie theoretic identification, this constant function is the canonical basis element of $i\mathbb{R}$, hence purely Lie theoretically it is to be called " i ".

With this notation then the Poisson bracket, written in the form that makes its Lie integration manifest, indeed reads

$$[q, p] = i .$$

Since the choice of basis element of $i\mathbb{R}$ is arbitrary, we may rescale here the i by any non-vanishing real number without changing this statement. If we write " \hbar " for this element, then the Poisson bracket instead reads

$$[q, p] = i\hbar.$$

This is of course the hallmark equation for quantum physics, if we interpret \hbar here indeed as Planck's constant, def. 4.4.128. We see it arises here merely by considering the non-trivial (the interesting, the non-simply connected) Lie integration of the Poisson bracket.

This is only the beginning of the story of quantization, naturally understood and indeed "derived" from applying Lie theory to classical mechanics. From here the story continues. It is called the story of *geometric quantization*. We close this motivation section here by some brief outlook.

The quantomorphism group which is the non-trivial Lie integration of the Poisson bracket is naturally constructed as follows: given the symplectic form ω , it is natural to ask if it is the curvature 2-form of a $U(1)$ -principal connection ∇ on complex line bundle L over X (this is directly analogous to Dirac charge quantization when instead of a symplectic form on phase space we consider the the field strength 2-form of electromagnetism on spacetime). If so, such a connection (L, ∇) is called a *prequantum line bundle* of the phase space (X, ω) . The quantomorphism group is simply the automorphism group of the prequantum line bundle, covering diffeomorphisms of the phase space (the Hamiltonian symplectomorphisms mentioned above).

As such, the quantomorphism group naturally acts on the space of sections of L . Such a section is like a wavefunction, except that it depends on all of phase space, instead of just on the "canonical coordinates". For purely abstract mathematical reasons (which we won't discuss here, but see at *motivic quantization* for more) it is indeed natural to choose a "polarization" of phase space into canonical coordinates and canonical momenta and consider only those sections of the prequantum line bundle which depend only on the former. These are the actual *wavefunctions* of quantum mechanics, hence the *quantum states*. And the subgroup of the quantomorphism group which preserves these polarized sections is the group of exponentiated quantum observables. For instance in the simple case mentioned before where (X, ω) is the 2-dimensional symplectic vector space, this is the Heisenberg group with its famous action by multiplication and differentiation operators on the space of complex-valued functions on the real line.

1.2.10.13 Integrable systems, moment maps and maps into the Poisson bracket

Remark 1.2.268. Given a phase space (pre-)symplectic manifold (X, ω) , and given $n \in \mathbb{N}$, then Lie algebra homomorphisms

$$\mathbb{R}^n \longrightarrow \mathfrak{pois}(X, \omega)$$

from the abelian Lie algebra on n generators into the Poisson bracket Lie algebra, def. 1.2.222 are equivalently choices of n -tuples of Hamiltonians $\{H_i\}_{i=1}^n$ (and corresponding Hamiltonian vector fields v_i) that pairwise commute with each other under the Poisson bracket, $\forall_{i,j} \{H_i, H_j\} = 0$. If the set $\{H_i\}_i$ is maximal with this property and one of the H_i is regarded the time evolution Hamiltonian of a physical system, then one calls this system *integrable*.

By the discussion in 1.2.10.12, the Lie integration of the Lie algebra homomorphism $\mathbb{R}^n \longrightarrow \mathfrak{pois}(X, \omega)$ is a morphism of smooth groupoids

$$\mathbf{B}(\mathbb{R}^n) \longrightarrow \mathbf{BAut}_{/BU(1)_{\text{conn}}}(\nabla) \hookrightarrow \mathbf{H}_{/BU(1)_{\text{conn}}}$$

from the smooth delooping groupoid (def. 1.2.243) of \mathbb{R}^n , now regarded as the translation group of n -dimensional Euclidean space, to the automorphism group of any pre-quantization of the phase space (its quantomorphism group).

Remark 1.2.269. Below in 1.2.11.3 we re-encounter this situation, but in a more refined context. There we find that n -dimensional classical field theory is encoded by a homomorphism of the form

$$\mathbb{R}^n \longrightarrow \mathfrak{pois}(X, \omega),$$

where however now ω is a closed differential form of degree $(n + 1)$ and where $\mathfrak{pois}(X, \omega)$ is a homotopy-theoretic refinement of the Poisson bracket Lie algebra (a *Lie n -algebra* or $(n - 1)$ -type in homotopy Lie

algebras). In that context such a homomorphism does not encode a set of strictly Poisson-commuting Hamiltonians, but a of Hamiltonian flows in the n spacetime directions of the field theory which commute under an n -ary higher bracket only *up to* a specified homotopy. That specified homotopy is the de Donder-Weyl-Hamiltonian of classical field theory.

Remark 1.2.270. For \mathfrak{g} any Lie algebra and (X, ω) a (pre-)symplectic manifold, a Lie algebra homomorphism

$$\mathfrak{g} \longrightarrow \mathbf{pois}(X, \omega)$$

is called a *moment map*. Equivalently this is an action of \mathfrak{g} by Hamiltonian vector fields *with* chosen Hamiltonians. The Lie integration of this is a homomorphism of smooth groups

$$G \longrightarrow \mathbf{Aut}_{/BU(1)_{\text{conn}}} \simeq \mathbf{QuantMorph}(X, \omega)$$

from a Lie group integrating \mathfrak{g} to the quantomorphism group. This is called a *Hamiltonian G -action*.

1.2.10.14 Classical anomalies and projective symplectic reduction Above in 1.2.10.7 we saw that for a gauge symmetry to act consistently on a phase space, it needs to act by *Hamiltonian diffeomorphisms*, because this is the data necessary to put a gauge-equivariant structure on the symplectic potential (hence on the pre-quantization of the phase space).

Under mild conditions every single infinitesimal gauge transformation comes from a Hamiltonian. But these Hamiltonians may not combine to a genuine Hamiltonian action, remark 1.2.270, but may be specified only up to addition of a locally constant function, and it may happen that these locally constant “gauges” may not be chosen globally for the whole gauge group such as to make the whole gauge group act by Hamiltonians. This is the lifting problem of pre-quantization discussed above in 1.2.10.9.

But if the failure of the local Hamiltonians to combine to a global Hamiltonian is sufficiently coherent in that it is given by a *group 2-cocycle*, then one can at least find a Hamiltonian action by a central extension of the gauge group. This phenomenon is known as a *classical anomaly* in field theory:

Definition 1.2.271. Let (X, ω) be a phase space symplectic manifold and let $\rho : G \times X \longrightarrow X$ be a smooth action of a Lie group G on the underlying smooth manifold by Hamiltonian symplectomorphisms, hence a group homomorphism

$$G \longrightarrow \mathbf{HamSymp}(X, \omega) .$$

Then we say this system has a *classical anomaly* if this morphism lifts to the quantomorphism group, prop. 3.9.13.5, only up to a central extension $\widehat{G} \longrightarrow G$, hence if it fits into the following diagram of smooth group, without the dashed diagonal morphism existing:

$$\begin{array}{ccc} \widehat{G} & \longrightarrow & \mathbf{QuantMorph}(X, \omega) \\ \downarrow & \nearrow & \downarrow \\ G & \xrightarrow{\rho} & \mathbf{HamSymp}(X, \omega) \end{array} .$$

This is the Lie-integrated version of the Lie-algebraic definition in appendix 5 of [Ar89]. For a list of examples of classical anomalies in field theories see [Top01].

Remark 1.2.272. Comparison with prop. 3.9.13.5 above shows that for (X, ω) a symplectic group acting on itself by Hamiltonian symplectomorphism, then its Heisenberg group is the “universal classical anomaly”.

1.2.11 Hamilton-De Donder-Weyl field theory via Higher correspondences

We now turn attention from just classical *mechanics* (hence of dynamics along a single parameter, such as the Hamiltonian time parameter in 1.2.10.6 above) to, more generally, classical *field theory*, which is

dynamics parameterized by higher dimensional manifolds (“spacetimes” or “worldvolumes”). Or rather, we turn attention to the *local* description of classical field theory. See also section 3.9.14 below.

Namely, the situation of example 1.2.190 above, where a trajectory of a physical system is given by a 1-dimensional curve $[0, 1] \rightarrow Y$ in a space Y of fields can – and traditionally is – also be applied to field theory, if only we allow Y to be a smooth space more general than a finite-dimensional manifold. Specifically, for a field theory on a parameter manifold Σ_n of some dimension n (to be thought of as spacetime or as the “worldvolume of a brane”), and for **Fields** a smooth moduli space of fields, a *local* field configuration is a map

$$\phi : \Sigma_n \rightarrow \mathbf{Fields}.$$

If however $\Sigma_d \simeq \Sigma_{d-1} \times \Sigma_1$ is a cylinder with $\Sigma_1 = [0, 1]$ over a base manifold Σ_{d-1} (a *Cauchy surface* if we think of Σ as spacetime), then such a map is equivalently a map out of the interval into the mapping space of Σ_{d-1} into **Fields**:

$$\phi_{\Sigma_{d-1}} : \Sigma_1 \rightarrow [\Sigma_{d-1}, \mathbf{Fields}].$$

This brings the field theory into the form of example 1.2.190, but at the cost of making it “spatially non-local”: for instance the energy of the system, as discussed in 1.2.10.6, would at each point of Σ_1 be the energy contained in the fields over all of Σ_{d-1} , while the information that this energy arises from integrating contributions localized along Σ_{d-1} is lost.

In more mathematical terms this means that by *transgression to codimension 1* classical field theory takes the form of classical mechanics as discussed above in 1.2.10.6. To “localize” the field theory again (make it “extended” or “multi-tiered”) we have to undo this process and “de-transgress” classical mechanics to full codimension.

At the level of Hamilton’s differential equations, def. 1.2.217, such a localization is “well known”, but much less famous than Hamilton’s equations: it is the multivariable variational calculus of Carathéodory, de Donder, and Weyl, as reviewed for instance in section 2 of [HHél02]. Below in 1.2.11.3 we show that the de Donder-Weyl equation secretly describes the Lie integration of a higher Poisson bracket Lie algebra in direct but higher analogy to how in 1.2.10.12 we saw that the ordinary Hamilton equations exhibit the Lie integration of the ordinary Poisson bracket Lie algebra.

From this one finds that an n -dimensional *local* classical field theory is described not by a symplectic 2-form as a system of classical mechanics is, but by a differential $(n + 1)$ -form which transgresses to the 2-form after passing to mapping spaces. This point of view has been explored under the name of “covariant mechanics” or “multisymplectic geometry” (see [FoRo05] for a review) and “ n -plectic geometry”, see 4.4.20 below. Here we show, based on the results in [FRS13a], how both of these approaches are unified and “pre-quantized” to a global description of local classical field theory by systems of higher correspondences in higher slices toposes, in higher generalization to the picture which we found in 1.2.10.11 for classical mechanics.

- 1.2.11.1 – Local field theory Lagrangians and n -plectic smooth spaces
- 1.2.11.2 – Local observables, conserved currents and higher Poisson brackets
- 1.2.11.3 – Field equations of motion and Higher Poisson-Maurer-Cartan elements
- 1.2.11.4 – Source terms, off-shell Poisson bracket and Poisson holography

1.2.11.1 Local field theory Lagrangians and n -plectic smooth spaces Traditionally, a classical field over a *spacetime* Σ is encoded by a fiber bundle $E \rightarrow X$, the *field bundle*. The fields on X are the sections of E .

Example 1.2.273. Let $d \in \mathbb{N}$ and let $\Sigma = \mathbb{R}^{d-1,1}$ be the d -dimensional real vector space, regarded as a pseudo-Riemannian manifold with the Minkowski metric η (*Minkowski spacetime*). Let moreover F be

a finite dimensional real vector space – the *field fiber* – equipped with a positive definite bilinear form k . Consider the bundle $\Sigma \times F \rightarrow \Sigma$, to be called the *field bundle*, and write

$$(X \rightarrow \Sigma) := (j_{\infty}^1(\Sigma \times F) \rightarrow \Sigma)$$

for its first jet bundle.

If we denote the canonical coordinates of Σ by $\sigma^i : \Sigma \rightarrow \mathbb{R}$ for $i \in \{0, \dots, n-1\}$, and choose a dual basis

$$\phi^a : F \rightarrow \mathbb{R}$$

of F (hence with $a \in \{1, \dots, \dim(V)\}$) then X is the vector space with canonical dual basis elements labeled by

$$\{\sigma^i\}, \{\phi^a\}, \{\phi_{,i}^a\}$$

and equipped with bilinear form $(\eta \oplus k \oplus (\eta \otimes k))$. While all of these are coordinates on X , traditionally one says that

1. the functions

$$\sigma^i : X \longrightarrow \mathbb{R}$$

are the *spacetime coordinates*;

2. the functions

$$\phi^a : X \longrightarrow \mathbb{R}$$

are the *canonical coordinates* of the F -field

3. the functions

$$p_a^i := \eta^{ij} k_{ab} \phi_{,j}^b : X \longrightarrow \mathbb{R}$$

are the *canonical momenta* of the *free* F -field.

Definition 1.2.274. Given a field bundle $X = j_{\infty}^1(\Sigma \times F) \rightarrow \Sigma$ as in example 1.2.273, the *free field theory local kinetic Lagrangian* is the horizontal differential n -form

$$L_{\text{kin}}^{\text{loc}} \in \Omega^{n,0}(X)$$

given by

$$\begin{aligned} L_{\text{kin}}^{\text{loc}} &:= \langle \nabla \phi, \nabla \phi \rangle \wedge \text{vol}_{\Sigma} \\ &:= \left(\frac{1}{2} k_{ab} \eta^{ij} \phi_{,i}^a \phi_{,j}^b \right) \wedge \mathbf{d}\sigma^1 \wedge \dots \wedge \mathbf{d}\sigma^d \end{aligned}$$

(where a sum over repeated indices is understood). Here we regard the volume form of Σ canonically as a horizontal differential form on the first jet bundle

$$\text{vol}_{\Sigma} := \mathbf{d}\sigma^1 \wedge \dots \wedge \mathbf{d}\sigma^a \in \Omega_{\Sigma}^{d,0}(X).$$

The localized analog of example 1.2.190 is now the following.

Definition 1.2.275. Given a free field bundle as in example 1.2.273 and given a horizontal n -form

$$L^{\text{loc}} \in \Omega^{n,0}(X)$$

on its first jet bundle, regarded as a local Lagrangian as in def. 1.2.274, then the associated *Lagrangian current* is the n -form

$$\theta^{\text{loc}} \in \Omega^{n-1,1}(X)$$

given by the formula

$$\theta^{\text{loc}} := \iota_{\partial_i} \left(\frac{\partial}{\partial \phi^a} L^{\text{loc}} \right) \wedge \mathbf{d}\phi^a$$

(where again a sum over repeated indices is understood). We say that the corresponding *pre-symplectic current* or *pre- n -plectic form* [FRS13b] is

$$\omega^{\text{loc}} := \mathbf{d}\theta^{\text{loc}}.$$

Remark 1.2.276. The formula in def. 1.2.275 is effectively that for the pre-symplectic current as it arises in the discussion of *covariant phase spaces* in [Zu87, CrWi87]. In the coordinates of example 1.2.273 the Lagrangian current reads

$$\theta^{\text{loc}} = p_a^i \wedge \mathbf{d}\phi^a \wedge \iota_{\partial_i} \text{vol}_\Sigma$$

and hence the pre-symplectic current reads

$$\omega^{\text{loc}} = \mathbf{d}p_a^i \wedge \mathbf{d}\phi^a \wedge \iota_{\partial_i} \text{vol}_\Sigma$$

In this form this is manifestly the $(n-1, 1)$ -component of the canonical “multisymplectic form” that is considered in multisymplectic geometry, see for instance section 2 of [HH  02].

This direct relation between the covariant phase space formulation and the multisymplectic description of local classical field theory seems not to have been highlighted much in the literature. It essentially appears in section 3.2 of [FoRo05] and in section 2.1 of [Rom05].

Example 1.2.277. Consider the simple case $d = 1$ hence $\Sigma = \mathbb{R}$, and $F = \mathbb{R}$, both equipped with the canonical bilinear form on \mathbb{R} (given by multiplication). Jet prolongation followed by evaluation yields the smooth function

$$\text{ev}_\infty : [\Sigma, F] \times \Sigma \xrightarrow{(j_\infty, \text{id})} \Gamma_\Sigma(X) \times \Sigma \xrightarrow{\text{ev}} X.$$

Then the pullback of the local free field Lagrangian of def. 1.2.274 along this map is the kinetic Lagrangian of example 1.2.191:

$$L_{\text{kin}} = \text{ev}_\infty^* L_{\text{kin}}^{\text{loc}}.$$

The pullback of the corresponding Lagrangian current according to def. 1.2.275 is the pre-symplectic potential θ in example 1.2.190

$$\theta = \text{ev}_\infty^* \theta^{\text{loc}}.$$

Definition 1.2.278. For $d \in \mathbb{N}$, write $\Sigma = \Sigma_1 \times \Sigma_{d-1}$ for the decomposition of Minkowski spacetime into a time axis Σ_1 and a spatial slice Σ_{d-1} , hence with $\Sigma_1 = \mathbb{R}$ the real line. Restrict attention to sections of the field bundle which are periodic in all spatial directions, hence pass to the $(d-1)$ -torus $\Sigma_{d-1} := \mathbb{R}^d / \mathbb{Z}^d$ (in order to have a compact spatial slice). Then given a free field local Lagrangian as in def. 1.2.274, say that its *transgression to codimension 1* is the pullback of the local Lagrangian n -form along

$$\text{ev}_\infty : [\Sigma_1, [\Sigma_{d-1}, F \times \Sigma_1 \times \Sigma_{d-1}] \xrightarrow{\simeq} [\Sigma, F] \times \Sigma \xrightarrow{(j_\infty, \text{id})} \Gamma_\Sigma(X) \times \Sigma \xrightarrow{\text{ev}} X$$

followed by fiber integration $\int_{\Sigma_{d-1}}$ over space Σ_{d-1} , to be denoted

$$L_{\text{kin}} := \int_{\Sigma_{d-1}} \text{ev}_\infty^* L_{\text{kin}}^{\text{loc}}.$$

Similarly the transgression to codimension 1 of the Lagrangian current, def. 1.2.275 is

$$\theta := \int_{\Sigma_{d-1}} \text{ev}_\infty^* \theta^{\text{loc}}.$$

Remark 1.2.279. This is the standard way in which the kinetic Lagrangians in example 1.2.190 arise by transgression of local data.

It is useful to combine this data as follows.

Definition 1.2.280. Given a first jet bundle $j_\infty^1(\Sigma \times X)$ as in example 1.2.273, we write

1. $j_\infty^1(\Sigma \times X)^* \rightarrow \Sigma \times X$ for its fiberwise linear densitized dual, as a bundle over the field bundle, to be called the *dual first jet bundle*;
2. $j_\infty^1(\Sigma \times X)^\vee \rightarrow X\Sigma \times X$ for the fiberwise affine densitized dual, to be called the *affine dual first jet bundle*.

Remark 1.2.281. With respect to the canonical coordinates in example 1.2.273, the canonical coordinates of the dual first jet bundle are $\{\sigma^i, \phi^a, p_a^i\}$ (spacetime coordinates, fields and canonical field momenta) and the canonical coordinates of the affine dual first jet bundle are $\{\sigma^i, \phi^a, p_a^i, e\}$ with one more coordinate e .

Definition 1.2.282. 1. The *canonical pre- n -plectic form* on the affine dual first jet bundle, def. 1.2.280, is

$$\omega_e := \mathbf{d}\phi^a \wedge \mathbf{d}p_a^i \wedge \iota_{\partial_{\sigma^i}} \text{vol}_\Sigma + \mathbf{d}e \wedge \text{vol}_\Sigma \in \Omega^{n+1}(j^1(\Sigma \times X)^\vee).$$

2. Given a function $H \in C^\infty(j^1(\Sigma \times X)^*)$ on the linear dual first jet bundle, def. 1.2.280, then the corresponding *DWH pre- n -plectic form* is

$$\omega_H := \mathbf{d}\phi^a \wedge \mathbf{d}p_a^i \wedge \iota_{\partial_{\sigma^i}} \text{vol}_\Sigma + \mathbf{d}H \wedge \text{vol}_\Sigma \in \Omega^{n+1}(j^1(\Sigma \times X)^*).$$

Definition 1.2.283 (local Legendre transform). Given a local Lagrangian as in def. 1.2.274, hende a horizontal n -form $L^{\text{loc}} \in \Omega^{(n,0)}(J^1(E))$ on the jets of the field bundle, its *local Legendre transform* is the function

$$\mathbb{F}L^{\text{loc}} : J^1(X) \longrightarrow (J^1(X))^\vee$$

from jets to the affine dual jet bundle, def. 1.2.280 which is the first order Taylor series of L^{loc} .

This definition was suggested in section 2.5 of [FoRo05]. It conceptualizes the traditional notion of local Legendre transform:

Example 1.2.284. In the local coordinates of example 1.2.273, the Legendre transform of a local Lagrangian L^{loc} , def. 1.2.283 has affine dual jet bundle coordinates given by

$$p_a^i = \frac{\partial L^{\text{loc}}}{\partial \phi_{,i}^a}$$

and

$$e = L^{\text{loc}} - \frac{\partial L^{\text{loc}}}{\partial \phi_{,i}^a} \phi_{,i}^a.$$

The latter expression is what is traditionally taken to be the local Legendre transform of L^{loc} .

The following observation relates the canonical pre- n -plectic form ω_e on the affine dual jet bundle to the central ingredients of the covariant phase space formalism.

Proposition 1.2.285. *Given a local Lagrangian $L^{\text{loc}} \in \Omega^{(n,0)}(J^1(E))$, then the pullback of the canonical pre- n -plectic form ω_e , def. 1.2.282, along the local Legendre transform $\mathbb{F}L^{\text{loc}}$ of def. 1.2.283 is the sum of the Euler-Lagrange equation term $\text{EL}_{L^{\text{loc}}} \in \Omega^{(n,1)}(J^1(X))$ and of the canonical pre- n -plectic current $\mathbf{d}_v \theta_{L^{\text{loc}}} \in \Omega^{(n-1,2)}(J^1(X))$ of def. 1.2.275:*

$$\begin{aligned} \omega_{L^{\text{loc}}} &:= (\mathbb{F}L^{\text{loc}})^* \omega_e \\ &= \text{EL}_{L^{\text{loc}}} + \mathbf{d}_v \theta_{L^{\text{loc}}} \end{aligned}$$

This follows with equation (54) and theorem 1 of [FoRo05].² In 1.2.11.3 below we see how using this the equations of motion of the field theory are naturally expressed.

In conclusion, we find that where phase spaces in classical mechanics are given by smooth spaces equipped with a closed 2-form, phase spaces in “de-transgressed” or “covariant” or “localized” classical field theory of dimension n are given by smooth spaces equipped with a closed $(n + 1)$ -form. To give this a name we say [FRS13a]:

Definition 1.2.286. For $n \in \mathbb{N}$, a *pre- n -plectic smooth space* is a smooth space X and a smooth closed $(n + 1)$ -form

$$\omega : X \longrightarrow \Omega_{\text{cl}}^{n+1},$$

hence an object of the slice topos

$$(X, \omega) \in \mathbf{H}/\Omega_{\text{cl}}^{n+1}.$$

1.2.11.2 Local observables, conserved currents and higher Poisson brackets Above in 1.2.10.5 we discussed how functions on a phase space are interpreted as observables of states of the mechanical system, for instance the energy of the system. Now in 1.2.11.1 above we saw that that notably the energy of an n -dimensional field theory at some moment in time (over some spatial hyperslice of spacetime) is really the integral over $(d - 1)$ -dimensional space Σ_{d-1} of an *energy density* $(d - 1)$ -form H^{loc} , hence by def. 1.2.278 the transgression of an $(n - 1)$ -form on the localized n -plectic phase space:

$$H = \int_{\Sigma_{n-1}} \text{ev}_{\infty}^* H^{\text{loc}}.$$

Therefore in analogy with the notion of observables on a symplectic manifold, given an n -plectic manifold, def. 1.2.286, its degree- $(n - 1)$ differential forms may be called the *local observables* of the system. To motivate from physics how exactly to formalize such local observables (which we do below in def. 1.2.288), we first survey how such local observables appear in the physics literature:

Example 1.2.287 (currents in physics as local observables). In the situation of example 1.2.273, consider a vector field $j \in \Gamma(T\Sigma_d)$ on the d -dimensional Minkowski spacetime $\Sigma_d = \mathbb{R}^{d-1,1}$. In physics this represents a quantity which – for an inertial observer characterized by the coordinates chosen in example 1.2.273 – has local density j^0 at each point in space and time, of a quantity that flows through space as given by the vector (j^1, \dots, j^{d-1}) .

For instance in the description of electric sources distributed in spacetime, the component j^0 would be an *electric charge density* and the vector (j^1, \dots, j^{d-1}) would be the *electric current density*. To emphasize that therefore j combines the information of a spatial current with the density of the substance that flows, traditional physics textbooks call j a “ d -current” – usually a “4-current” when identifying d with the number of macroscopic spacetime dimensions of the observable universe. But once the spacetime context is understood, one just speaks of j as a *current*.

The currents of interest in physics are those which satisfy a *conservation law*, a law which states that the change in coordinate time σ^0 of the density j^0 is equal to the negative of the divergence of the spatial current, hence that the spacetime divergence of j vanishes:

$$\text{div}(j) = \frac{\partial j^0}{\partial \sigma^0} + \sum_{i=1}^{n-1} \frac{\partial j^i}{\partial \sigma_i} = 0.$$

If this is the case, one calls the current j a *conserved current*. (Beware that the “conserved” is so important in applications that it is often taken to be implicit and notationally suppressed.)

² This statement and its formulation in terms of notions in the variational bicomplex as given here has kindly been amplified to us by Igor Khavkine.

In order to formulate the notion of divergence of a vector field intrinsically (as opposed with respect to a chosen coordinate system as above), one needs a specified volume form $\text{vol}_\Sigma \in \Omega^d(\Sigma_d)$ of spacetime. With that given, the divergence $\text{div}(j) \in C^\infty(\Sigma_d)$ of the vector field is defined by the equation

$$\text{div}(j) \wedge \text{vol}_{\Sigma_d} := \mathcal{L}_j \text{vol}_{\Sigma_d} = \mathbf{d}(\iota_j \text{vol}_\Sigma) .$$

In particular, a current j is a conserved current precisely if the degree- $(n-1)$ differential form

$$J := \iota_j \text{vol}_{\Sigma_d}$$

is a closed differential form

$$(j \in \Gamma(T\Sigma_d) \text{ is a conserved current}) \Leftrightarrow (\mathbf{d}J = 0) .$$

Due to this and related relations, one finds eventually that the degree- $(d-1)$ differential form J itself is the more fundamental mathematical reflection of the physical current. But by the above introduction, this is in turn the same as saying that a current is a local observable. Accordingly, we will often use the terms “current” and “local observable” interchangeably.

If currents are local observables, then by the above discussion their integral over a spatial hyperslice of spacetime is to be the corresponding global observable. In the special case of the electromagnetic current J_{el} , the laws of electromagnetism in the form of *Maxwell's equation*

$$J_{\text{el}} = \mathbf{d} \star F_{\text{em}}$$

say that this integral – assuming now that J_{el} is spatially compactly supported – is the integral of the Hodge dual electromagnetic field strength F_{em} over the boundary of a 3-ball $D^3 \hookrightarrow \Sigma_{d-1}$ enclosing the support of the electromagnetic current. This is the *total electric charge* Q_{el} in space:

$$Q_{\text{el}} = \int_{S^2} \star F_{\text{em}} = \int_{D^3} J_{\text{el}} = \int_{\Sigma_{d-1}} J_{\text{el}} .$$

Based on this example, in physics one generally speaks of the integral of a spacetime current over space as a *charge*. So charges are the global observables of the local observables, which are currents.

Notice that for a *conserved* current the corresponding charge is also conserved in that it does not change with time or in fact under any isotopy of Σ_{d-1} inside Σ_d , due to Stokes' theorem:

$$\begin{aligned} \mathbf{d}_{\Sigma_1} Q &= \mathbf{d}_{\Sigma_1} \int_{\Sigma_{d-1}} J \\ &= \int_{\Sigma_{d-1}} \mathbf{d}_{\Sigma_d} J \cdot \\ &= 0 \end{aligned}$$

Therefore currents in physics are necessarily subject of *higher gauge equivalences*: if J is a conserved current $(d-1)$ -form, then for any $(d-2)$ -form α the sum $J + \mathbf{d}\alpha$ is also a conserved current, which, by Stokes' theorem, has the same total charge as J in any $(d-1)$ -ball in space, and has the same flux as J through the boundary of that $(d-1)$ -ball. This means that the conserved currents J and $J + \mathbf{d}\alpha$ are physically equivalent, while nominally different, hence that α exhibits a *gauge equivalence transformation* between currents

$$\alpha : J \xrightarrow{\simeq} (J' = J + \mathbf{d}\alpha) .$$

The analogous consideration holds for α itself: for any $(d-3)$ -form β also $\alpha + \mathbf{d}\beta$ exhibits a gauge transformation between the currents J and J' above. One says this is a *gauge of gauge*-transformation or a *higher gauge transformation* of second order. This phenomenon continues up to the 0-forms (the smooth functions), which therefore are $(d-1)$ -fold higher gauge transformations between conserved currents on a d -dimensional spacetime.

Finally notice that in a typical application to physics, a current form J is naturally defined also “off shell”, hence for all field configurations (say of the electromagnetic field), but its conservation law only holds “on shell”, hence when these field configurations satisfy their equations of motion (to which we come below in 1.2.11.3). Since the n -plectic localized phase spaces in the discussion in 1.2.11.1 above a priori contain all field configurations, we are not to expect that a local observable $(d-1)$ -form J is a conserved current only if its differential strictly vanishes, but already if its differential vanishes at least on those d -tuples of vector fields $v_1 \vee \cdots \vee v_d$ which are tangent to jets of those sections of the field bundle that satisfy their equations of motion:

$$(J \text{ is conserved current}) \Leftrightarrow ((v_1 \vee \cdots \vee v_d \text{ satisfies field equations of motion}) \Rightarrow \iota_{v_1 \vee \cdots \vee v_n} \mathbf{d}J = 0) .$$

This we formalize below by the “ n -plectic Noether theorem”, prop. 1.2.296. There we will see how such conserved current $(d-1)$ -forms arise from vector fields v that constitute infinitesimal symmetries of a Hamiltonian function, by the evident higher degree generalization of Hamilton’s equations, namely $\mathbf{d}J = \iota_v \omega$.

In summary, example 1.2.287 motivates the following definition (first proposed in [Rog11a] and then interpreted in homotopy topos theory in [FRS13a, FRS13b]) of the localized/higher analog of the Poisson bracket Lie algebra of observables, defs. 1.2.220, 1.2.222, as we pass from global observable on (pre-)symplectic manifolds to local observables on (pre-) n -plectic manifolds. The general abstract characterization of the following definition, (which appeared first in [Rog10]) we give below in 3.9.13.5, see the discussion in 4.4.20.

Definition 1.2.288 (higher Poisson bracket of local observables). Given a pre- n -plectic manifold (X, ω) , its vector space of *local Hamiltonian observables* is

$$\Omega_\omega^{n-1}(X) := \{(v, J) \in \Gamma(TX) \oplus \Omega^{n-1}(X) \mid \iota_v \omega = -\mathbf{d}J\} .$$

We say that the de Rham complex ending in these Hamiltonian observables is the *complex of local observables* of (X, ω) , denoted

$$\Omega_\omega^\bullet(X) := \left(C^\infty(X) \xrightarrow{\mathbf{d}} \Omega^1(X) \xrightarrow{\mathbf{d}} \cdots \xrightarrow{\mathbf{d}} \Omega^{n-2}(X) \xrightarrow{(0, \mathbf{d})} \Omega_\omega^{n-1}(X) \right) .$$

The *binary higher Poisson bracket* on local Hamiltonian observables is the linear map

$$\{-, -\} : \Omega_\omega^{n-1}(X) \otimes \Omega_\omega^{n-1}(X) \longrightarrow \Omega_\omega^{n-1}(X)$$

given by the formula

$$[(v_1, J_1), (v_2, J_2)] := [([v_1, v_2], \iota_{v_1 \vee v_2} \omega)] ;$$

and for $k \geq 3$ the *k -ary higher Poisson bracket* is the linear map

$$\{-, \dots, -\} : (\Omega_\omega^{n-1}(X))^{\otimes k} \longrightarrow \Omega_\omega^{n+1-k}(X)$$

given by the formula

$$[(v_1, J_1), \dots, (v_k, J_k)] := (-1)^{\lfloor \frac{k-1}{2} \rfloor} \iota_{v_1 \vee \dots \vee v_k} \omega .$$

The chain complex of local observables equipped with these linear maps for all k we call the *higher Poisson bracket homotopy Lie algebra* of (X, ω) , denoted

$$\mathbf{pois}(X, \omega) := (\Omega_\omega^\bullet(X), \{-, -\}, \{-, -, -\}, \dots) .$$

Remark 1.2.289. What we call a *homotopy Lie algebra* in def. 1.2.288 is what originally was called a *strong homotopy Lie algebra* and what these days is mostly called an L_∞ -*algebra* or, since the above chain complex is concentrated in the lowest n degrees, a *Lie n -algebra*. These are the structures that are to group-like smooth homotopy types as Lie algebras are to smooth groups. The reader can find all further details which we need not dwell on here as well as pointers to the standard literature in [FRS13b].

Remark 1.2.290. For $n = 2$ definition 1.2.288 indeed reproduces the definition of the ordinary Poisson bracket Lie algebra, def. 1.2.222.

1.2.11.3 Field equations of motion and Higher Poisson-Maurer-Cartan elements Where in classical mechanics the equations of motion that determine the physically realized trajectories are Hamilton's equations, def. 1.2.217, in field theory the equations of motion are typically *wave equations* on spacetime. But as we localize from (pre-)symplectic phase spaces to (pre-) n -plectic phase spaces as in 1.2.11.1 above, Hamilton's equations also receive a localization to the *Hamilton-de Donder-Weyl* equation. This indeed coincides with the field-theoretic equations of motion. We briefly review the classical idea of de Donder-Weyl formalism and then show how it naturally follows from a higher geometric version of Hamilton's equations in n -plectic geometry.

Definition 1.2.291. Let (X, ω) be a pre- n -plectic smooth manifold, and let $H \in C^\infty(X)$ be a smooth function, to be called the *de Donder-Weyl Hamiltonian*. Then for $v_i \in \Gamma(TX)$ with $i \in \{1, \dots, n\}$ an n -tuple of vector fields, the *Hamilton-de Donder-Weyl* equation is

$$(\iota_{v_n} \cdots \iota_{v_1})\omega = \mathbf{d}H.$$

Generally, for $J \in \Omega^{n-k}(X)$ a smooth differential form for $1 \leq k \leq n$, and for $\{v_i\}$ a k -tuple of vector fields, the *extended Hamilton-deDonder-Weyl equation* is

$$\iota_{v_k} \cdots \iota_{v_1}\omega = \mathbf{d}J.$$

We now first show how this describes equations of motion of field theories. Then we discuss how this de Donder-Weyl-Hamilton equation is naturally found in higher differential geometry. For simplicity of exposition we stick with the simple local situation of example 1.2.273. The ambitious reader can readily generalize all of the following discussion to non-trivial and non-linear field bundles.

Definition 1.2.292. Let $\Sigma \times X \rightarrow \Sigma$ be a field bundle as in example 1.2.273. For $\Phi := (\phi^i, p_i^a) : \Sigma \rightarrow j^1(\Sigma \times X)^*$ a section of the linear dual jet bundle write

$$v_i^\Phi = \frac{\partial}{\partial \sigma^i} + \frac{\partial \phi^a}{\partial \sigma^i} \frac{\partial}{\partial \phi^a} + \frac{\partial p_a^j}{\partial \sigma^i} \frac{\partial}{\partial p_a^j}$$

for its canonical basis of tangent vector fields. Similarly for $\Phi := (\phi^i, p_i^a, e) : \Sigma \rightarrow j^1(\Sigma \times X)^\vee$ a section of the affine dual jet bundle write

$$v_i^\Phi = \frac{\partial}{\partial \sigma^i} + \frac{\partial \phi^a}{\partial \sigma^i} \frac{\partial}{\partial \phi^a} + \frac{\partial p_a^j}{\partial \sigma^i} \frac{\partial}{\partial p_a^j} + \frac{\partial e}{\partial \sigma^i} \frac{\partial}{\partial e}$$

for its canonical basis of tangent vector fields.

Proposition 1.2.293. For $(\Sigma \times X) \rightarrow \Sigma$ a field bundle as in example 1.2.273, let $H \in C^\infty(j^1(\Sigma \times X)^*)$ be a function on the linear dual (and hence on the affine dual) first jet bundle. Then for a section Φ of the linear dual field bundle the homogeneous ("relativistic") de Donder-Weyl-Hamilton equation, def. 1.2.291, of the Hamiltonian pre- n -plectic form, def. 1.2.282,

$$(\iota_n^\Phi \cdots \iota_1^\Phi)\omega_H = 0$$

has a unique lift, up to an additive constant, to a solution of the DWH equation on the affine dual field bundle of the form

$$(\iota_n^\Phi \cdots \iota_1^\Phi)\omega_e = \mathbf{d}(H + e).$$

Moreover, both these equations are equivalent to the following system of differential equations

$$\partial_i \phi^a = \frac{\partial H}{\partial p_a^i} \quad ; \quad \partial_i p_a^i = -\frac{\partial H}{\partial \phi^a}.$$

The last system of differential equations is the form in which the de Donder-Weyl-Hamilton equation is traditionally displayed, see for instance theorem 2 [Rom05]. The inhomogeneous version on the affine dual first jet bundle above has been highlighted in [HHél02], around equation (4) there.

Example 1.2.294. For a field bundle as in example 1.2.273, the standard form of an energy density function for a field theory on Σ is

$$H \text{vol}_\Sigma = L_{\text{kin}} + V(\{\phi^a\}) \text{vol}_\Sigma,$$

where the first summand is the kinetic energy density from example 1.2.274 and where the second is any potential term as in example 1.2.191. More explicitly this means that

$$H = \langle \nabla \phi, \nabla \phi \rangle + V(\{\phi^a\}) = k^{ab} \eta_{ij} p_a^i p_b^j + V(\{\phi^a\}).$$

For this case the first component of the Hamilton-de Donder-Weyl equation in the form of prop. 1.2.293 is the equation

$$\partial_i \phi^a = k^{ab} \eta_{ij} p_b^j.$$

This identifies the canonical momentum with the actual momentum. More formally, this first equation *enforces the jet prolongation* in that it forces the section of the dual first jet bundle to the field bundle to be the actual dual jet of an actual section of the field bundle.

Using this, the second component of the DWH equation in the form of prop. 1.2.293 is equivalently the *wave equation*

$$\eta^{ij} \partial_i \partial_j \phi^a = - \frac{\partial V}{\partial \phi^a}$$

with inhomogeneity given by the gradient of the potential. These equations are the hallmark of classical field theory.

In full generality we can express the Euler-Lagrange equations of motion of a local Lagrangian in Hamilton-de Donder-Weyl form by prop. 1.2.285.

In order for the Hamilton-de Donder-Weyl equation to qualify as a good “localization” or “de-transgression” of non-covariant classical field theory as in example 1.2.190 it should be true that it reduces to this under transgression. This is indeed the case³

Proposition 1.2.295. *With $\omega_{L^{\text{loc}}}$ as in prop. 1.2.285, we have that for any Cauchy surface Σ_{n-1} that transgression of $\omega_{L^{\text{loc}}}$ yields the covariant phase space pre-symplectic form of example 1.2.190.*

Using the n -plectic formulation of the Hamilton-de Donder-Weyl equation, we naturally obtain now the following n -plectic formulation of the refinement of the “symplectic Noether theorem”, def. 1.2.225, from mechanics to field theory:

Proposition 1.2.296 (n -plectic Noether theorem). *Let (X, ω) be a pre- n -plectic manifold equipped with a function $H \in C^\infty(X)$, to be regarded as a de Donder-Weyl Hamiltonian. If a vector field $v \in \Gamma(TX)$ is a symmetry of H in that*

$$\iota_v \mathbf{d}H = 0,$$

then along any n -vector field $v_1 \vee \cdots \vee v_n$ which solves the Hamilton-de Donder-Weyl equation, def. 1.2.291, the corresponding current $\mathbf{J}_v := \iota_v \omega$ is conserved, in that

$$\iota_{(v_1, \dots, v_n)} \mathbf{d}J_v = 0.$$

Conversely, if a current is conserved on solutions to the Hamilton-de Donder-Weyl equations of motion this way, then it generates a symmetry of the de Donder-Weyl Hamiltonian.

³ Again thanks go to Igor Khavkine for discussion of this point.

Proof. By the various definitions and assumptions we have

$$\begin{aligned}
\iota_{v_1 \vee \dots \vee v_n} \mathbf{d}J_{n+1} &= \iota_{v_1 \vee \dots \vee v_n} \iota_v \omega \\
&= (-)^n \iota_v \iota_{v_1 \vee \dots \vee v_n} \omega \\
&= \iota_v \mathbf{d}H \\
&= 0
\end{aligned}$$

□

This shows how the multisymplectic/ n -plectic analog of the symplectic formulation of Hamilton's equations, def. 1.2.217, serves to encode the equations of motion, the symmetries and the conserved currents of classical field theory. But in 1.2.10.10 and 1.2.10.12 above we had seen that the symplectic formulation of Hamilton's equations in turn is equivalently just an infinitesimal characterization of the automorphisms of a pre-quantized phase space $X \xrightarrow{\nabla} \mathbf{B}U(1)_{\text{conn}}$ in the higher slice topos $\mathbf{H}/_{\mathbf{B}U(1)_{\text{conn}}}$. This suggests that n -dimensional Hamilton-de Donder-Weyl flows should characterize n -fold homotopies in the higher automorphism group of a higher prequantization, regarded as an object in a higher slice topos to be denoted $\mathbf{H}/_{\mathbf{B}^n U(1)_{\text{conn}}}$. This we come to below in 3.9.13.5.

Here we now first consider the infinitesimal aspect this statement. To see what this will look like, observe that the statement for $n = 1$ is that the Lie algebra of slice automorphisms of ∇ is the Poisson bracket Lie algebra $\mathbf{pois}(X, \omega)$ whose elements, by def. 1.2.222, are precisely the pairs (v, H) that satisfy Hamilton's equation $\iota_v \omega = H$. To say this more invariantly: Hamilton's equations on (X, ω) precisely characterize the Lie algebra homomorphisms of the form

$$\mathbb{R} \longrightarrow \mathbf{pois}(X, \omega),$$

where on the left we have the abelian Lie algebra on a single generator. This suggests that for a (pre-) n -plectic manifold, we consider homotopy Lie algebra homomorphism of the form

$$\mathbb{R}^n \longrightarrow \mathbf{pois}(X, \omega),$$

where now on the left we have the abelian Lie algebra on n generators, regarded canonically as a homotopy Lie algebra. In comparison with prop. 1.2.233, this may be thought of as characterizing the infinitesimal approximation to an evolution n -functor from Riemannian n -dimensional cobordisms into the (delooping of) the higher Lie integration of $\mathbf{pois}(X, \omega)$ (recall remark 1.2.268 above).

Such homomorphisms of homotopy Lie algebras are computed as follows.

Definition 1.2.297. Given a pre- n -plectic smooth space (X, ω) , write

$$\mathbf{pois}(X, \omega)^{(\square^n)} := (\wedge^\bullet \mathbb{R}^n) \otimes \mathbf{pois}(X, \omega)$$

for the homotopy Lie algebra obtained from the Poisson bracket Lie n -algebra of def. 1.2.288 by tensoring with the Grassmann algebra on n generators, hence the graded-symmetric algebra on n generators in degree 1.

Remark 1.2.298. A basic fact of homotopy Lie algebra theory implies that homomorphisms of the form $\mathbb{R}^n \longrightarrow \mathbf{pois}(X, \omega)$ are equivalent to elements $\mathcal{J} \in \mathbf{pois}(X, \omega)^{\Delta^n}$ of degree 1, which satisfy the *homotopy Maurer-Cartan equation*

$$d\mathcal{J} + \frac{1}{2}\{\mathcal{J}, \mathcal{J}\} + \frac{1}{6}\{\mathcal{J}, \mathcal{J}, \mathcal{J}\} + \dots = 0$$

Example 1.2.299. Write $\{\mathbf{d}\sigma^i\}_{i=1}^n$ for the generators of $\wedge^\bullet \mathbb{R}^n$. Then a general element of degree 1 in $\mathbf{pois}(X, \omega)^{(\square^n)}$ is of the form

$$\mathcal{J} = \mathbf{d}\sigma^i \otimes (v_i, J_i) + \mathbf{d}\sigma^i \wedge \mathbf{d}\sigma^j \otimes J_{ij} + \mathbf{d}\sigma^i \wedge \mathbf{d}\sigma^j \wedge \mathbf{d}\sigma^k \otimes J_{ijk} + \dots + (\mathbf{d}\sigma^1 \wedge \dots \wedge \mathbf{d}\sigma^n) \otimes H,$$

where

1. $v_i \in \Gamma(TX)$ is a vector field and $J_i \in \Omega^n(X)$ is a differential n -forms such that $\iota_{v_i}\omega = \mathbf{d}J_i$
2. $J_{i_1 \dots i_k} \in \Omega^{n+1-k}(X)$;
3. $H \in C^\infty(X)$.

From this we deduce the following.

Proposition 1.2.300. *Given a pre- n -plectic smooth space (X, ω) , the extended Hamilton-de Donder-Weyl equations, def. 1.2.291, characterize, under the identification of example 1.2.299, the homomorphisms of homotopy Lie algebras from \mathbb{R}^n into the higher Poisson bracket Lie n -algebra of def. 1.2.288:*

$$(\mathcal{J} : \mathbb{R}^n \longrightarrow \mathbf{pois}(X, \omega)) \Leftrightarrow \begin{cases} \iota_{v_n} \cdots \iota_{v_1} \omega = \mathbf{d}H \\ \iota_{v_{i_k}} \cdots \iota_{v_{i_2}} \iota_{v_{i_1}} \omega = \mathbf{d}J_{i_1 i_2 \dots i_k} \quad \forall_k \forall_{i_1, \dots, i_k} \end{cases}$$

Remark 1.2.301. The Lie integration of the Lie n -algebra $\mathbf{pois}(X, \omega)$ is the smooth n -groupoid whose n -cells are Maurer-Cartan elements in

$$\Omega_{\text{si}}^\bullet(\Delta^n) \otimes \mathbf{pois}(X, \omega),$$

see [FSS10] for details. The construction in def. 1.2.297 is a locally constant approximation to that. In general there are further σ -dependent terms.

Due to [FRS13a, FRS13b] we have that the Lie integration of $\mathbf{pois}(X, \omega)$ is the automorphism n -group $\mathbf{Aut}_{/\mathbf{B}^n U(1)_{\text{conn}}}(\nabla)$ of any pre-quantization ∇ of (X, ω) , see 3.9.13. This means that the above maps

$$\mathbb{R}^n \longrightarrow \mathbf{pois}(X, \omega)$$

are infinitesimal approximations to something lie n -functors of the form

$$\text{“ } \mathbf{Bord}_n^{\text{Riem}} \longrightarrow \mathbf{H}_{/\mathbf{B}^n U(1)_{\text{conn}}} \text{ ”}$$

in higher dimensional analogy of prop. 1.2.233. This we come to below.

1.2.11.4 Source terms, off-shell Poisson bracket and Poisson holography We connect now the discussion of mechanics in 1.2.10 to that of higher Chern-Simons field theory in by showing that the space of all trajectories of a mechanical system naturally carries a Poisson bracket structure which is foliated by symplectic leafs that are labeled by source terms.⁴ The corresponding leaf space is naturally refined to the symplectic groupoid that is the moduli stack of fields of the non-perturbative 2s Poisson-Chern-Simons theory. This yields a precise implementation of the “holographic principle” where the 2d Poisson-Chern-Simons theory in the bulk carries on its boundary a 1d field theory (mechanical system) such that fields in the bulk correspond to sources on the boundary.

Let (X, ω) be a symplectic manifold. We write

$$\{-, -\} : C^\infty(X) \otimes C^\infty(X) \longrightarrow C^\infty(X)$$

for the Poisson bracket induced by the symplectic form ω , hence by the Poisson bivector $\pi := \omega^{-1}$.

For notational simplicity we will restrict attention to the special case that

$$X = \mathbb{R}^2 \simeq T^*\mathbb{R}$$

with canonical coordinates

$$q, p : \mathbb{R}^2 \longrightarrow \mathbb{R}$$

⁴This phenomenon was kindly pointed out to by Igor Khavkine.

and symplectic form

$$\omega = \mathbf{d}q \wedge \mathbf{d}p.$$

The general case of the following discussion is a straightforward generalization of this, which is just notationally more inconvenient.

Write $I := [0, 1]$ for the standard interval regarded as a smooth manifold with boundary—with boundary. The mapping space

$$PX := [I, X]$$

canonically exists as a smooth space, but since I is compact topological space—compact this structure canonically refines to that of a Frchet manifold. This implies that there is a good notion of tangent space TPX . The task now is to construct a certain Poisson bivector as a section $\pi \in \Gamma^{\wedge 2}(TPX)$.

Among the smooth functions on PX are the evaluation maps

$$ev : PX \times I = [I, X] \times I \longrightarrow X$$

whose components we denote, as usual, for $t \in I$ by

$$q(t) := q \circ ev_t : PX \longrightarrow \mathbb{R}$$

and

$$p(t) := p \circ ev_t : PX \longrightarrow \mathbb{R}.$$

Generally for $f: X \rightarrow \mathbb{R}$ any smooth function, we write $f(t) := f \circ ev_t \in C^\infty(PX)$. This defines an embedding

$$C^\infty(X) \times I \hookrightarrow C^\infty(PX).$$

Similarly we have

$$\dot{q}(t) : PX \longrightarrow \mathbb{R}$$

and

$$\dot{p}(t) : PX \longrightarrow \mathbb{R}$$

obtained by differentiation of $t \mapsto q(t)$ and $t \mapsto p(t)$.

Let now

$$H : X \times I \longrightarrow \mathbb{R}$$

be a smooth function, to be regarded as a time-dependent Hamiltonian. This induces a time-dependent function on trajectory space, which we denote by the same symbol

$$H : PX \times I \xrightarrow{(ev, id)} X \times X \xrightarrow{H} \mathbb{R}.$$

Hence for $t \in I$ we write

$$H(t) : PX \times \{t\} \xrightarrow{(ev, id)} X \times \{t\} \xrightarrow{H} \mathbb{R}$$

for the function that assigns to a trajectory $(q(-), p(-)) : I \rightarrow X$ its energy at (time) parameter value t . Define then the Euler-Lagrange equation—Euler-Lagrange density induced by H to be the functions

$$EL(t) : PX \longrightarrow \mathbb{R}^2$$

with components

$$EL(t) = \begin{pmatrix} \dot{q}(t) - \frac{\partial H}{\partial p}(t) \\ \dot{p}(t) + \frac{\partial H}{\partial q}(t) \end{pmatrix}.$$

The trajectories $\gamma : I \rightarrow X$ on which $EL(t)$ vanishes for all $t \in I$ are equivalently those

- for which the tangent vector $\dot{\gamma} \in T_\gamma X$ is a Hamiltonian vector field—Hamiltonian vector for H ;
- which satisfy Hamilton's equations of motion—of motion for H .

Since the differential equations $EL = 0$ have a unique solution for given initial data $(q(0), p(0))$, the evaluation map

$$\{\gamma \in PX \mid \forall_{t \in I} EL_\gamma(t) = 0\} \xrightarrow{\gamma \mapsto \gamma(0)} X$$

is an equivalence (an isomorphism of smooth spaces).

Write

$$\text{Poly}(PX) \hookrightarrow C^\infty(PX)$$

for the subalgebra of smooth functions on path space which are polynomials of integrals over I , of the smooth functions in the image of $C^\infty(X) \times I \hookrightarrow C^\infty(PX)$ and all their derivatives along I .

Define a bilinear function

$$\{-, -\} : \text{Poly}(PX) \otimes \text{Poly}(PX) \longrightarrow \text{Poly}(PX)$$

as the unique function which is a derivation in both arguments and moreover is a solution to the differential equations

$$\begin{aligned} \frac{\partial}{\partial t_2} \{f(t_1), q(t_2)\} &= \left\{ f(t_1), \frac{\partial H}{\partial p}(t_2) \right\} \\ \frac{\partial}{\partial t_2} \{f(t_1), p(t_2)\} &= - \left\{ f(t_1), \frac{\partial H}{\partial q}(t_2) \right\} \end{aligned}$$

subject to the initial conditions

$$\begin{aligned} \{f(t), q(t)\} &= \{f, q\} \\ \{f(t), p(t)\} &= \{f, p\} \end{aligned}$$

for all $t \in I$, where on the right we have the original Poisson bracket on X .

This bracket directly inherits skew-symmetry and the Jacobi identity from the Poisson bracket of (X, ω) , hence equips the vector space $\text{Poly}(PX)$ with the structure of a Lie bracket. Since it is by construction also a derivation of $\text{Poly}(PX)$ as an associative algebra, we have that

$$(\text{Poly}(PX), \{-, -\}) \in P_1 \text{Alg}$$

is a Poisson algebra. This is the “off-shell Poisson algebra” on the space of trajectories in (X, ω) .

Observe that by construction of the off-shell Poisson bracket, specifically by the differential equations defining it, the Euler-Lagrange equation—Euler-Lagrange function EL generate a Poisson reduction—Poisson ideal.

For instance

$$\left(\begin{array}{l} \frac{\partial}{\partial t_2} \{f(t_1), q(t_2)\} = \left\{ f(t_1), \frac{\partial H}{\partial p}(t_2) \right\} \\ \frac{\partial}{\partial t_2} \{f(t_1), p(t_2)\} = - \left\{ f(t_1), \frac{\partial H}{\partial q}(t_2) \right\} \end{array} \right) \Leftrightarrow (\{f(t_1), EL(t)\} = 0).$$

Moreover, since $\{EL(t) = 0\}$ are equations of motion the Poisson reduction defined by this Poisson idea is the subspace of those trajectories which are solutions of Hamilton's equations, hence the “on-shell trajectories”.

As remarked above, the initial value map canonically identifies this on-shell trajectory space with the original phase space manifold X . Moreover, by the very construction of the off-shell Poisson bracket as being the original Poisson bracket at equal times, hence in particular at time $t = 0$, it follows that restricted to the zero locus $EL = 0$ the off-shell Poisson bracket becomes symplectic manifold—symplectic.

All this clearly remains true with the function EL replaced by the function $EL - J$, for $J \in C^\infty(I)$ any function of the (time) parameter (since $\{J, -\} = 0$). Any such choice of J hence defines a symplectic subspace

$$\{\gamma \in PX \mid \forall_{t \in I} EL_\gamma(t) = J\}$$

of the off-shell Poisson structure on trajectory space. Hence $(OX, \{-, -\})$ has a foliation by symplectic leaves with the leaf space being the smooth space $C^\infty(I)$ of smooth functions on the interval.

Notice that changing $EL \mapsto EL - J$ corresponds changing the time-dependent Hamiltonian H as

$$H \mapsto H - Jq.$$

Such a term linear in the canonical coordinates (the field (physics)—fields) is a *source term*. (The action functionals with such source terms added serve as integrands of generating functions for correlators in statistical mechanics and in quantum mechanics.)

Hence in conclusion we find the following statement:

The trajectory space (history space) of a mechanical system carries a natural Poisson manifold—Poisson structure whose symplectic leaves are the subspaces of those trajectories which satisfy the equations of motion with a fixed source term and hence whose symplectic leaf space is the space of possible sources.

Notice what becomes of this statement as we consider the 2d Chern-Simons theory induced by the off-shell Poisson bracket (the non-perturbative field theory—non-perturbative Poisson sigma-model) whose moduli stack of field (physics)—fields is the symplectic groupoid $SG(PX, \{-, -\})$ induced by the Poisson structure.

By the discussion at ... the Poisson space $(PX, \{-, -\})$ defines a boundary field theory (in the sense of local prequantum field theory) for this 2d Chern-Simons theory, exhibited by a boundary correspondence of the form

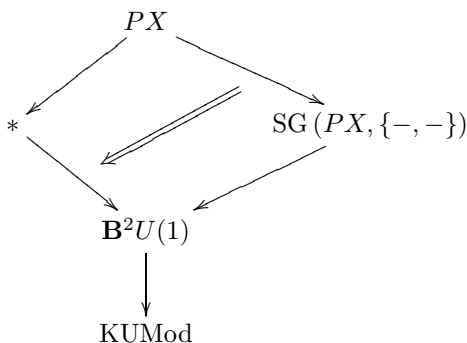

Notice that the symplectic groupoid is a version of the symplectic leaf—symplectic leaf space of the given Poisson manifold (its 0-truncation is exactly the leaf space). Hence in the case of the off-shell Poisson bracket, the symplectic groupoid is the space of *sources* of a mechanical system. At the same time it is the moduli space of field (physics)—fields of the 2d Chern-Simons theory of which the mechanical system is the boundary field theory. Hence the field (physics)—fields of the bulk field theory are identified with the sources of the boundary field theory. Hence conceptually the above boundary correspondence diagram is of the following form

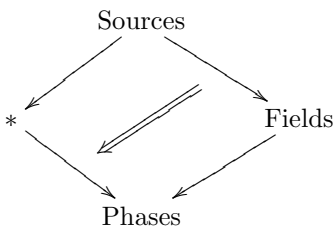

1.2.12 Higher pre-quantum gauge fields

We give an introduction and survey to some aspects of the formulation of higher prequantum field theory in a cohesive ∞ -topos.

One of the pleasant consequences of formulating the geometry of (quantum) field theory in terms of higher stacks, hence in terms of higher topos theory, is that a wealth of constructions find a natural and unified

formulation, which subsumes varied traditional constructions and generalizes them to higher geometry. In this last part here we give an outlook of the scope of field theoretic phenomena that the theory naturally captures or exhibits in the first place.

In the following we write \mathbf{H} for the collection of higher stacks under consideration. The reader may want to think of the special case that was discussed in the previous sections, where $\mathbf{H} = \text{Smooth}\infty\text{Grpd}$ is the collection of *smooth ∞ -groupoids*, hence of higher stacks on the site of smooth manifolds, or, equivalently, its dense subsite of Cartesian spaces. But one advantage of speaking in terms of higher topos theory is that essentially every construction considered in the following makes sense much more generally if only \mathbf{H} is any higher topos that satisfies a small set of axioms called (differential) *cohesion*. This allows one to transport all considerations across various kinds of geometries. Notably we can speak of higher *supergeometry*, hence of fermionic quantum fields, simply by refining the site of definition to be that of supermanifolds: also the higher topos $\mathbf{H} = \text{SmoothSuper}\infty\text{Grpd}$ is differentially cohesive.

Therefore we speak in the following in generality of *cohesive maps* when we refer to maps with geometric structure, be it topological, smooth, analytic, supergeometric or otherwise. Throughout, this geometric structure is *higher geometric* which we will sometimes highlight by adding the “ ∞ ”-prefix as in *cohesive ∞ -group*, but which we will often notationally suppress for brevity. Similarly, *all* of the diagrams appearing in the following are filled with homotopies, but only sometimes we explicitly display them (as double arrows) for emphasis or in order to label them.

The special case of *geometrically discrete* cohesion is exhibited by the ∞ -topos ∞Grpd of bare ∞ -groupoids or *homotopy types*. This is the context of traditional homotopy theory, presented by topological spaces regarded up to weak homotopy equivalences (“whe”s): $\infty\text{Grpd} \simeq L_{\text{whe}}\text{Top}$. One of the axioms satisfied by a cohesive ∞ -topos \mathbf{H} is that the inclusion $\text{Disc} : \infty\text{Grpd} \hookrightarrow \mathbf{H}$ of bare ∞ -groupoids as cohesive ∞ -groupoids equipped with discrete cohesive structure has not only a right adjoint $\Gamma : \mathbf{H} \rightarrow \infty\text{Grpd}$ – the functor that forgets the cohesive structure and remembers only the underlying bare ∞ -groupoid – but also a left adjoint $|-| : \mathbf{H} \rightarrow \infty\text{Grpd}$. This is the *geometric realization* of cohesive ∞ -groupoids.

We discuss first the general notion of (quantum) fields, then that of Lagrangians and action functionals on spaces of fields and the corresponding *phase spaces*, and finally we discuss the geometric prequantum theory of such data.

- 1.2.12 – Fields
- 1.2.13 – Phase spaces
- 1.2.14 – Prequantum geometry

The following discussion is based on and in part reviews previous work such as [SSS09c, FSS12c]. Lecture notes that provide an exposition of this material with an emphasis on fields as twisted (differential) cocycles are in [Sc12].

We discuss now how a plethora of species of (quantum) fields are naturally and precisely expressed by constructions in the higher topos \mathbf{H} . In fact, it is the *universal moduli stacks **Fields*** of a given species of fields which are naturally expressed: those objects such that maps $\phi : X \rightarrow \mathbf{Fields}$ into them are equivalently quantum fields of the given species on X . This has three noteworthy effects on the formulation of the corresponding field theory.

First of all it means that every quantum field theory thus expressed is formally analogous to a σ -model – the “target space” is a higher moduli stack – which brings about a unified treatment of varied types of QFTs.

Second it means that a differential cocycle on **Fields** of degree $(n + 1)$ – itself modulated by a map

$$\mathbf{L} : \mathbf{Fields} \rightarrow \mathbf{B}^n U(1)_{\text{conn}}$$

to the moduli stack n -form connections – serves as an *extended* Lagrangian of a field theory, in the sense that it expresses a QFT fully locally by Lagrangian data in arbitrary codimension: for every closed oriented

worldvolume Σ_k of dimension $k \leq n$ there is a *transgressed* Lagrangian

$$\exp(2\pi i \int_{\Sigma_k} [\Sigma_k, \mathbf{L}]) : \mathbf{Fields}(\Sigma_k) \xrightarrow{[\Sigma_k, \mathbf{L}]} [\Sigma_k, \mathbf{B}^n \mathbb{C}_{\text{conn}}] \xrightarrow{\exp(2\pi i \int_{\Sigma_k} (-))} \mathbf{B}^{n-k} \mathbb{C}_{\text{conn}}^\times$$

which itself is a differential $(n - k)$ -form connection on the space of fields on Σ_k . In particular, when $n = k$ then $\mathbf{B}^0 U(1)_{\text{conn}} \simeq U(1)$ and the transgressed Lagrangian in codimension 0 is the (exponentiated) *action functional* of the theory, $\exp(iS(-)) : \mathbf{Fields}(\Sigma_n) \rightarrow U(1)$. On the other hand, the $(n - k)$ -connections in higher codimension are higher (off-shell) *prequantum bundles* of the theory. This we discuss further below in 1.2.14.

Third, it means that the representation of fields by their higher moduli stacks in a higher topos identifies the notion of quantum field entirely with that of *cocycle* in general *cohomology*. This we turn to now in 1.2.12.1.

1.2.12.1 Cocycles: generalized, parameterized, twisted We discuss general aspects of cocycles and cohomology in an ∞ -topos, as a general blueprint for all of the discussion to follow. The reader eager to see explicit structure genuinely related to (quantum) physics may want, on first reading, to skip ahead to 1.2.12.2 and come back here only as need be.

In higher topos theory the notion of *cocycle* c on some space X with coefficients in some object A and with some *cohomology* class $[c]$ is identified simply with that of a map (a morphism) $c : X \rightarrow A$ with equivalence class

$$[c] \in H(X, A) := \pi_0 \mathbf{H}(X, A).$$

This is traditionally familiar for the case of discrete geometric structure hence bare homotopy theory $\mathbf{H} = \infty \text{Grpd}$, where for any Eilenberg-Steenrod-*generalized cohomology theory* the object E is the corresponding spectrum, as given by the Brown representability theorem. That over non-trivial sites the same simple formulation subsumes all of *sheaf cohomology* (“parameterized cohomology”) is known since [Br73], but it appears in the literature mostly in a bit of disguise in terms of some explicit model of a *derived global section functor*, computed by means of suitable projective/injective resolutions.)

If here $A = \mathbf{Fields}$ is interpreted as the moduli stack of certain *fields*, then such a cocycle *is* a field configuration on X . This is familiar for the case that we think of $A = X$ as the target space of a σ -*model*. But for instance for $G \in \text{Grp}(\mathbf{H})$ a (higher) group and $A := \mathbf{B}G_{\text{conn}}$ a differential refinement of the universal moduli stack of G -principal ∞ -bundles, a map $c : X \rightarrow \mathbf{B}G_{\text{conn}}$ is on the one hand a cocycle in (nonabelian) differential G -cohomology on X , and on the other hand equivalently a G -*gauge field* on X . In particular this means that in higher topos theory gauge field theories are unified with σ -models: an (untwisted) gauge field is a σ -model field whose target space is a universal differential moduli stack $\mathbf{B}G_{\text{conn}}$.

Indeed, the kinds of fields which are identified as σ -model fields in higher topos theory, hence with cocycles in some geometric cohomology theory, is considerable richer, still. The reason for this is that with $B \in \mathbf{H}$ any object, the *slice* $\mathbf{H}/_B$ is itself again a higher topos. This slice topos is the collection of morphisms of \mathbf{H} into B , where a map between two such morphisms $f_{1,2} : X_{1,2} \rightarrow B$ is

1. a map $\phi : X_1 \rightarrow X_2$ in \mathbf{H}
2. a homotopy $\eta : f_1 \xrightarrow{\simeq} f_2 \circ \phi$,

$$\begin{array}{ccc} X_1 & \xrightarrow{\phi} & X_2 \\ & \searrow f_1 & \swarrow f_2 \\ & & B \end{array} \quad \begin{array}{c} \swarrow \eta \\ \end{array}$$

hence a diagram in \mathbf{H} of the form

. We are particularly interested in the case that

$B = \mathbf{B}G$ is a moduli stack of G -principal ∞ -bundles (or a differential refinement thereof). The fact that \mathbf{H} is *cohesive* implies in particular that every morphism $g : X \rightarrow \mathbf{B}G$ has a unique global homotopy fiber

$P \rightarrow X$. This is the G -principal bundle over X modulated by g , sitting in a long homotopy fiber sequence of the form

$$\begin{array}{ccc} G & \longrightarrow & P \\ & & \downarrow \\ & & X \xrightarrow{g} \mathbf{B}G \end{array} .$$

In particular this means that there is an action of G on P (precisely: a *homotopy coherent* or A_∞ -action) and that

$$P \rightarrow P//G \simeq X$$

is the quotient map of this action. Moreover, conversely every action of G on any object $V \in \mathbf{H}$ arises this way and is modulated by a morphism $V//G \xrightarrow{\rho} \mathbf{B}G$, sitting in a homotopy fiber sequence of the form

$$\begin{array}{ccc} V & \longrightarrow & V//G \\ & & \downarrow \rho \\ & & \mathbf{B}G \end{array} .$$

(This and the following facts about G -principal ∞ -bundles in ∞ -toposes and the representation theory and twisted cohomology of cohesive ∞ -groups is due to [NSS12a], an account in the present context is in section 3.6 here.) This fiber sequence exhibits $V//G \rightarrow \mathbf{B}G$ as the universal V -fiber bundle which is ρ -associated to the universal G -principal bundle over $\mathbf{B}G$. For instance the fiber sequence $G \rightarrow * \rightarrow \mathbf{B}G$ which defines the delooping of G corresponds to the action of G on itself by right (or left) multiplication; the fiber sequence $V \longrightarrow V \times \mathbf{B}G \xrightarrow{p_2} \mathbf{B}G$ corresponds to the trivial action on any V , and the fiber sequence $G \longrightarrow \mathcal{L}\mathbf{B}G \longrightarrow \mathbf{B}G$ of the free loop space object of $\mathbf{B}G$ corresponds to the adjoint action of G on itself.

Another case of special interest is that where $V \simeq \mathbf{B}A$ and $V//G \simeq \mathbf{B}\hat{G}$ are themselves deloopings of ∞ -groups. In this case the above fiber sequence reads

$$\mathbf{B}A \longrightarrow \mathbf{B}\hat{G} \longrightarrow \mathbf{B}G$$

and exhibits an *extension* \hat{G} of G by A . The implied action of G on $\mathbf{B}A$ via $\mathbf{Aut}(\mathbf{B}G) \simeq \mathbf{Aut}_{\text{Grp}}(G)//\text{ad}$ is the datum known from traditional *Schreier theory* of general (nonabelian) group extensions. Now the previous discussion implies that if A is equipped with sufficient abelian structure in that also $\mathbf{B}A$ is equipped with ∞ -group structure (a “braided ∞ -group”) and such that $\mathbf{B}\hat{G} \rightarrow \mathbf{B}G$ is the quotient projection of a $\mathbf{B}A$ -action, then the extension is classified by an ∞ -group cocycle $\mathbf{c} : \mathbf{B}G \longrightarrow \mathbf{B}^2A$ in ∞ -group cohomology $[\mathbf{c}] \in H_{\text{grp}}^2(G, A)$. Notice that this is *cohesive* group cohomology in that it does respect and reflect the geometric structure on G and A . Notably in smooth cohesion and for G a Lie group and $A = \mathbf{B}^n K$ the n -fold delooping of an abelian Lie group, this reproduces not the naive Lie group cohomology but the refined Segal-Brylinski Lie group cohomology (this is shown in section 4.4.6.2 here). This implies that for G a compact Lie group and $A = \mathbf{B}^n U(1)$ we have an equivalence

$$H_{\text{Grp}}^n(G, U(1)) \simeq H^{n+1}(BG, \mathbb{Z})$$

between the refined cohesive group cohomology with coefficients in the circle group and the ordinary integral cohomology of the clasifying space $BG \simeq |\mathbf{B}G|$ in one degree higher. In other words this means that every *universal characteristic class* $c : BG \longrightarrow K(\mathbb{Z}, n+1)$ is cohesively refined essentially uniquely to (the instanton sector of) a higher gauge field: a cohesive circle n -bundle (bundle $(n-1)$ -gerbe) on the universal moduli stack $\mathbf{B}G$. The “universality” of this higher gauge field is reflected in the fact that this is really the (twisting structure underlying) an *extended action function for higher Chern-Simons theory* controlled by the given universal class. This we come back to below in 1.2.12.3.

From this higher bundle theory, higher group theory and higher representation theory, we obtain a finer interpretation of maps in the slice $\mathbf{H}/\mathbf{B}G$. First of all one finds that

$$\mathbf{H}/\mathbf{B}G \simeq G\mathbf{Act}$$

is indeed the ∞ -category of G -actions and G -action homomorphisms. In particular the base change functors $(\mathbf{G}\phi)_*$ and $(\mathbf{B}\phi)!$ along maps $\mathbf{B}\phi : \mathbf{B}G \rightarrow \mathbf{B}G'$ corresponds to the (co)induction functors from G -representations to G' -representations along a group homomorphism ϕ . Since all this is homotopy-theoretic (“derived”) the space of maps in the slice from the trivial representation to any given representation (V, ρ) (hence the *derived invariants* of (V, ρ)) is the cocycle ∞ -groupoid of the *group cohomology* of G with *coefficients* in V :

$$H_{\text{Grp}}(G, V) \simeq \pi_0 \mathbf{H}/\mathbf{B}G(\text{id}_{\mathbf{B}G}, \rho).$$

We are interested in the generalizations of this to the case where the univereal G -principal ∞ -bundle modulated by $\text{id}_{\mathbf{B}G}$ is replaced by any G -principal bundle modulated by a map $g_X : X \rightarrow \mathbf{B}G$. To see what general cocycles in $\mathbf{H}/\mathbf{B}G(g_X, \rho)$ are like, notice that every G -principal ∞ -bundle over a given X locally trivializes over a cover $U \twoheadrightarrow X$ (an *effective epimorphism* in \mathbf{H}) in that the modulating map becomes null-homotopic on U : $g_X|_U \simeq \text{pt}_{\mathbf{B}G}$. But by the universal property of homotopy fibers this means that a cocycle $\sigma : g_X \rightarrow \rho$ in $\mathbf{H}/\mathbf{B}G$ is *locally* a cocycle $\sigma|_U : U \rightarrow V$ in \mathbf{H} with coefficients in the given G -module V , as shown on the left of the following diagram:

$$\begin{array}{ccc} U & \xrightarrow{\sigma|_U} & V \\ \downarrow & & \downarrow \\ X & \xrightarrow{\sigma} & V//G \\ & \searrow^{g_X} & \swarrow_{\rho} \\ & \mathbf{B}G & \end{array} \quad \simeq \quad \begin{array}{ccccccc} & & V & \longrightarrow & P \times_G V & \longrightarrow & V//G \\ & \nearrow^{\sigma|_U} & & \nearrow^{\sigma} & \downarrow & & \downarrow^{\rho} \\ U & \twoheadrightarrow & X & \xrightarrow{\text{id}} & X & \xrightarrow{g_X} & \mathbf{B}G \end{array}.$$

This means that σ is a cocycle with *local coefficients* in V , which however globally vary as controlled by g_X : it is *twisted* by g_X . On the right hand of the above diagram the same situation is displayed in an equivalent alternative perspective: since $\rho : V//G \rightarrow \mathbf{B}G$ is also the univereal ρ -associated V -fiber bundle, it follows that the V -fiber bundle $P \times_G V \rightarrow X$ associated to $P \rightarrow X$ is its pullback along g_X and then using again the universal property of the homotopy pullback it follows that σ is equivalently a *section* of this associated bundle. This is the traditional perspective of *g_X -twisted V -cohomology* as familiar notably from twisted K -theory, as well as from modern formulations of ordinary cohomology with local coefficients.

The perspective of twisted cohomology as cohomology in slice ∞ -topos $\mathbf{H}/\mathbf{B}G$ makes it manifest that what acts on twisted cocycle spaces are *twist homomorphisms*, hence maps $(\phi, \eta) : g_Y \rightarrow g_X$ in $\mathbf{H}/\mathbf{B}G$. In particular for g_X and given twist its automorphism ∞ -group $\text{Aut}_{/\mathbf{B}G}(g_X)$ acts on the twisted cohomology $\mathbf{H}/\mathbf{B}G(g_X, \rho)$ by precomposition in the slice.

In conclusion we find that cocycles and fields in the slice slice ∞ -topos $\mathbf{H}/\mathbf{B}G$ of a cohesive ∞ -topos over the delooping of an ∞ -group are structures with components as summarized in the following diagram:

$$\begin{array}{ccccc} & & U & \longrightarrow & V \\ & & \downarrow & & \downarrow \\ Y & \longrightarrow & X & \longrightarrow & V//G \\ & \searrow & \downarrow & \swarrow & \\ & & \mathbf{B}G & & \end{array}$$

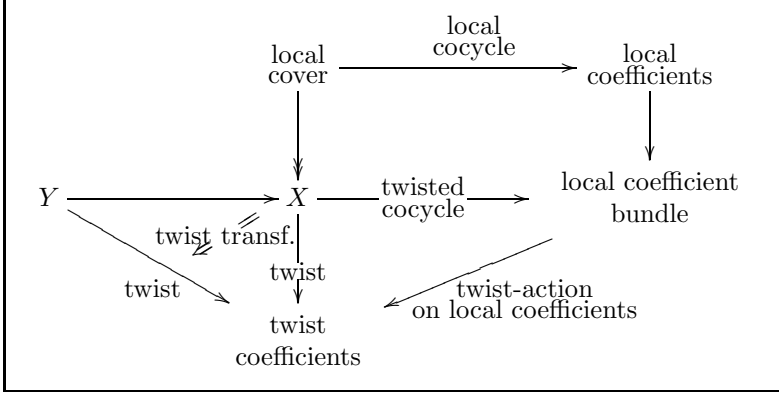

In the following we list a wide variety of classes of examples of this unified general abstract picture.

1.2.12.2 Fields of gravity: special and generalized geometry As special cases of the above general discussion, we now discuss moduli ∞ -stacks of *fields of gravity* and their generalizations as found in higher dimensional (super)gravity.

For $X \in \mathbf{Mfd}_n \hookrightarrow \mathbf{H}$ a manifold of dimension n , we may naturally regard it as an object in the slice $\mathbf{H}/\mathbf{BGL}(n)$ by way of the canonical map $\tau_X : X \rightarrow \mathbf{BGL}(n)$ that modulates its frame bundle, the principal $\mathbf{GL}(n)$ -bundle to which the tangent bundle TX is associated. A map $(\phi, \eta) : \tau_X \rightarrow \tau_Y$ in $\mathbf{H}/\mathbf{BGL}(n)$ between two manifolds X, Y embedded in this way is equivalently a *local diffeomorphism* $\phi : X \rightarrow Y$ equipped with an explicit choice $\eta : \phi^* \tau_Y \simeq \tau_X$ of identification of the pullback tangent bundle with that of X .

The slice topos $\mathbf{H}/\mathbf{BGL}(n)$ allows us to express physical fields which may not be restricted along arbitrary morphisms of manifolds (or morphisms of whatever kind of test geometries \mathbf{H} is modeled on), but only along local diffeomorphism, such as *metric/vielbein* fields or symplectic structures.

For let $\mathbf{OrthStruc}_n : \mathbf{BO}(n) \rightarrow \mathbf{BGL}(n)$ be the morphism of moduli stacks induced from the canonical inclusion of the orthogonal group into the general linear group, regarded as an object of the slice, $\mathbf{OrthStruc}_n \in \mathbf{H}/\mathbf{BGL}(n)$. Then a cocycle/field

$$(o_X, e) : \tau_X \rightarrow \mathbf{OrthStruc}_n$$

is equivalently

1. an *orthogonal structure* o_X on X (a choice of *Lorentz frame bundle*);
2. a *vielbein* field $e : \mathbf{OrthStruc}_n \circ o_X \longrightarrow \tau_X$ which equips the frame bundle with that orthogonal structure.

Together this is equivalently a *Riemannian metric* field on X , hence a field of Euclidean gravity, and $\mathbf{OrthStruc}_n \in \mathbf{H}/\mathbf{BGL}_n$ is the universal moduli stack of Riemannian metrics in dimension n . Notice that this defines a notion of Riemannian metric for any object in \mathbf{H} as soon as it is equipped with a $\mathbf{GL}(n)$ -principal bundle. We obtain actual pseudo-Riemannian metrics by considering instead the delooped inclusion of $O(n-1, 1)$ into $\mathbf{GL}(n)$ and obtain dS-geometry, AdS-geometry etc. by further varying the signature.

This notion of $\mathbf{OrthStruc}_n$ -structure in smooth stacks is of course closely related to the notion of orthogonal structure as considered in traditional homotopy theory. But there is a crucial difference, which we highlight now. First notice that there is a canonical ∞ -functor

$$|-| : \mathbf{H} \rightarrow \infty\text{Grpd} \simeq L_{\text{whe}}\text{Top}$$

which sends every cohesive ∞ -groupoid/ ∞ -stack to its *geometric realization*. Under certain conditions on the cohesive ∞ -group G , in particular for Lie groups as considered here, this takes the moduli stack \mathbf{BG} to

the traditional *classifying space* BG . So under this map a choice of vielbein turns into a homotopy lift as shown on the right of

$$\begin{array}{ccc}
 & \mathbf{BO}(n) & \\
 \nearrow^{o_X} & \downarrow & \\
 X & \xrightarrow{\tau_X} \mathbf{BGL}(n) & \\
 & \xrightarrow{|-|} & \\
 & \mathbf{BO}(n) & \\
 \nearrow^{|o_X|} & \downarrow \simeq & \\
 X & \xrightarrow{|\tau_X|} \mathbf{BGL}(n) &
 \end{array}$$

But since $O(n) \rightarrow \mathrm{GL}(n)$ is the inclusion of a maximal compact subgroup, it is a homotopy equivalence of the underlying topological spaces. Hence under $|-|$ a choice of $\mathbf{OrthStruc}_n$ -structure is no choice at all, up to equivalence, there is no information encoded in this choice. This is of course the familiar statement that every vector bundle *admits* an orthogonal structure. But only in the context of cohesive stacks is the *choice* of this orthogonal structure actually equivalent to geometric data, to a choice of Riemannian metric.

Also notice that the homotopy fiber of $\mathbf{OrthStruc}_n$ is the cohesive coset $\mathrm{GL}(n)/O(n)$ (the coset equipped with its smooth manifold structure) in that we have a fiber sequence

$$\mathrm{GL}(n)/O(n) \longrightarrow \mathbf{BO}(n) \xrightarrow{\mathbf{OrthStruc}_n} \mathbf{BGL}(n)$$

in \mathbf{H} , and by the discussion in 1.2.12.1 above a metric field $(o_X, e) : \tau_X \longrightarrow \mathbf{OrthStruc}_n$ is equivalently a τ_X -twisted $\mathrm{GL}(n)/O(n)$ -cocycle. This reproduces the traditional statement that the space of choices of vielbein fields is locally the space of maps into the coset $\mathrm{GL}(n)/O(n)$ and fails to be globally so to the extent that the tangent bundle is non-trivial.

Moreover, by the general discussion in 1.2.12.1 we find that a twist transformation that may act on orthogonal structures is a morphism $\tau_Y \rightarrow \tau_X$ in the slice $\mathbf{H}/\mathbf{BGL}(n)$. This is equivalently a cohesive map $\phi : Y \rightarrow X$ in \mathbf{H} equipped with an equivalence $\eta : \phi^*\tau_X \xrightarrow{\simeq} \tau_Y$ from the pullback of the tangent bundle on X to that on Y . But such an isomorphism precisely witnesses ϕ as a *local diffeomorphism*. Hence it is the local diffeomorphisms that act as twist morphisms on tangent bundles regarded as twists for $\mathrm{GL}(n)/O(n)$ -structures. This statement of course reproduces the traditional fact that metrics pull back along local diffeomorphisms (but not along more general cohesive maps). Abstractly it is reflected in the fact that the moduli stack $\mathbf{OrthStruc}_n$ for metrics in n dimensions is an object not of the base ∞ -topos \mathbf{H} , but of the slice $\mathbf{H}/\mathbf{BGL}(n)$.

In conclusion, the following diagram summarizes the components of the formulation of metric fields as cocycles in the slice over $\mathbf{BGL}(n)$, displayed as a special case of the general diagram for twisted cocycles that is discussed in 1.2.12.1.

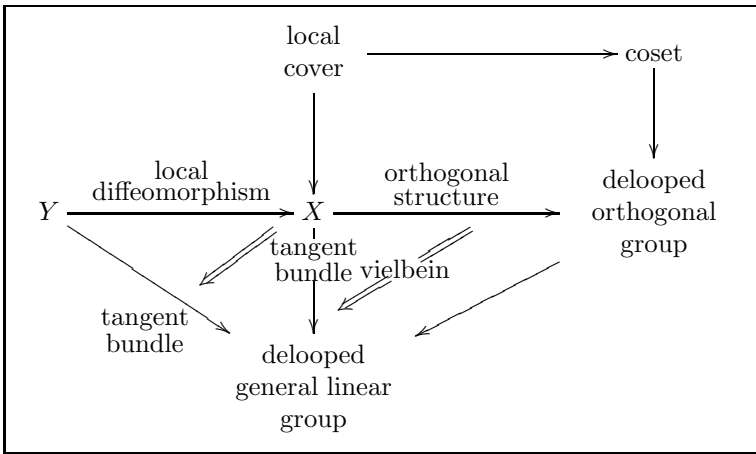

This discussion of metric structure and vielbein fields of gravity is but a special case of *generalized vielbein fields* obtained from *reduction of structure groups*. If $\mathbf{c} : K \rightarrow G$ is any morphism of groups in \mathbf{H} (typically

taken to be a subgroup inclusion if one is speaking of structure group *reduction*, but not necessarily so in general, as for instance the example of the *generalized tangent bundle*, discussed in a moment, shows), and if $\tau_X : X \rightarrow \mathbf{B}G$ is the map modulating a given G -structure on X , then a map $(\phi, \eta) : \tau_X \rightarrow \mathbf{c}$ in $\mathbf{H}/\mathbf{B}G$ is a generalized vielbein field on X which exhibits the reduction of the structure group from G to H along \mathbf{c} . These *c-geometries* are compatible with pullback along twist transformations $\eta : \tau_Y \rightarrow \tau_X$, namely along maps $\phi : Y \rightarrow X$ in \mathbf{H} which are *generalized local diffeomorphisms* in that they are equipped with an equivalence $\eta : \phi^* \mathbf{c} \xrightarrow{\cong} \tau_X$.

Of relevance in the T-duality covariant formulation of type II supergravity (“doubled field theory”) is the reduction along the inclusion of the maximal compact subgroup into the orthogonal group $O(n, n)$ (where $n = 10$ for full type II supergravity), whose delooping in \mathbf{H} we write

$$\mathbf{typeII} : \mathbf{B}(O(n) \times O(n)) \longrightarrow \mathbf{B}O(n, n) .$$

A spacetime X that is to carry a **typeII**-field accordingly must carry an $O(n, n)$ -structure in the first place in that it must be equipped with a lift of its tangent bundle $\tau_X \in \mathbf{H}/\mathbf{B}GL(n)$ in the slice over $\mathbf{B}GL(n)$, as discussed above, to an object τ_X^{gen} in the slice $\mathbf{H}/\mathbf{B}O(n, n)$. Since there is no suitable homomorphism from $O(n, n)$ to $GL(n)$, this lift needs to be through a subgroup of $O(n, n)$ that does map to $GL(n)$. The maximal such group is called the *geometric subgroup* $G_{\text{geom}}(n) \xrightarrow{\hookrightarrow} GL(n)$. We write

$$\begin{array}{ccc} \mathbf{B}G_{\text{geom}}(n) & \xrightarrow{\mathbf{B}\iota} & \mathbf{B}O(n, n) \\ \downarrow \text{genTan}_n & & \\ \mathbf{B}GL(n) & & \end{array}$$

in \mathbf{H} . Then for $X \in \text{Mfd} \hookrightarrow \mathbf{H}$ a spacetime, a map $(\tau_X^{\text{gen}}, \eta) : \tau_X \longrightarrow \text{genTan}_n$ in $\mathbf{H}/\mathbf{B}GL(n)$, hence a diagram

$$\begin{array}{ccc} X & \overset{\tau_X^{\text{gen}}}{\dashrightarrow} & \mathbf{B}G_{\text{geom}}(n) \\ \searrow \tau_X & \swarrow \eta & \swarrow \text{genTan}_n \\ & & \mathbf{B}GL(n) \end{array}$$

in \mathbf{H} , is called a choice of *generalized tangent bundle* for X . Given such, a map

$$(o_X^{\text{gen}}, e^{\text{gen}}) : \mathbf{B}\iota \circ \tau_X^{\text{gen}} \rightarrow \mathbf{typeII}$$

in the slice $\mathbf{H}/\mathbf{B}O(n, n)$ is equivalent to what is called a *generalized vielbein field* for *type II geometry* on X . This is a model for the generalized fields of gravity in the T-duality-covariant formulation of type II supergravity backgrounds. (See for instance section 2 of [GMPW08] for a review and see section 4 here for discussion in the present context.) So **typeII** $\in \mathbf{H}/\mathbf{B}O(n, n)$ is the moduli stack for T-duality covariant *type II gravity* fields.

Similarly, if X is a manifold of even dimension $2n$ equipped with a generalized tangent bundle, then a map $\tau_X^{\text{gen}} \longrightarrow \mathbf{genComplStruc}$ in the slice with coefficients in the canonical morphism

$$\mathbf{genComplStruc} : \mathbf{B}U(n, n) \longrightarrow \mathbf{B}O(2n, 2n)$$

in a *generalized complex structures* on τ_X . Such **genComplStruc**-fields appear in compactifications of supergravity on *generalized Calabi-Yau manifolds*, such that a global $N = 1$ supersymmetry is preserved.

Notice that the homotopy fiber sequence of the local coefficient bundle **typeII** is

$$O(n) \backslash O(n, n) / O(n) \longrightarrow \mathbf{B}O(n) \times O(n) \xrightarrow{\mathbf{typeII}} \mathbf{B}O(n, n)$$

in \mathbf{H} . The coset fiber on the left is the familiar local moduli spaces of generalized geometries known from the literature on T-duality and generalized geometry.

Notice also that the theory automatically determines what replaces the notion of *local diffeomorphism* in these generalized type II geometries: the generalized tangent bundles τ_X^{gen} now are the twists, and a twist transformation $(\phi, \eta) : \tau_Y^{\text{gen}} \rightarrow \tau_X^{\text{gen}}$ in $\mathbf{H}/\mathbf{B}G_{\text{geom}(n)}$ is therefore a cohesive map $\phi : Y \rightarrow X$ equipped with an equivalence $\eta : \phi^* \tau_X^{\text{gen}} \xrightarrow{\simeq} \tau_Y^{\text{gen}}$ in \mathbf{H} between the pullback of the generalized tangent bundle of Y and that of X .

One can consider this setup for moduli objects being arbitrary group homomorphisms $\text{genGeom} : \mathbf{BK} \rightarrow \mathbf{BG}$ regarded as objects in the slice \mathbf{H}/\mathbf{BG} . For instance the delooped inclusion

$$\mathbf{SuGraCompt}_n : \mathbf{BK}_n \longrightarrow \mathbf{BE}_{n(n)}$$

of the maximal compact subgroup of the exceptional Lie groups produces the moduli object for U -duality covariant fields of supergravity compactified on an n -dimensional fiber. A map $\tau_X^{\text{gen}} \longrightarrow \mathbf{SuGraCompt}_n$ is a generalized vielbein field in *exceptional generalized geometry* [Hull07]. Another type of exceptional geometry, that we will come back to below in 1.2.14, is that induced by the delooping

$$\mathbf{G}_2\mathbf{Struc} : \mathbf{BG}_2 \longrightarrow \mathbf{BGL}(7)$$

of the defining inclusion of the exceptional Lie group G_2 as the subgroup of those linear transformations of \mathbb{R}^7 which preserves the “associative 3-form” $\langle -, (-) \times (-) \rangle$. For X a manifold of dimension 7, a field $\phi : \tau_X \rightarrow \mathbf{G}_2\mathbf{Struc}$ is a G_2 -structure on X .

So far all the groups in the examples have been ordinary cohesive (Lie) groups, hence *0-truncated* cohesive ∞ -group objects in \mathbf{H} . More generally we have “reduction” of structure groups for general ∞ -groups exhibited by “higher vielbein fields” which are maps into moduli objects in a slice ∞ -topos.

One degree higher, the first example comes from central extensions

$$A \longrightarrow \hat{G} \longrightarrow G$$

of ordinary groups. These induce long fiber sequences

$$A \longrightarrow \hat{G} \longrightarrow G \xrightarrow{\Omega \mathbf{c}} \mathbf{BA} \longrightarrow \mathbf{B}\hat{G} \longrightarrow \mathbf{BG} \xrightarrow{\mathbf{c}} \mathbf{B}^2 A$$

in \mathbf{H} . Here \mathbf{c} is the (cohesive) group 2-cocycle that classifies the extension, exhibited as a \mathbf{BA} -2-bundle $\mathbf{B}\hat{G} \rightarrow \mathbf{BG}$. Generally an object $(X, \phi_X) \in \mathbf{H}/\mathbf{B}$ is an object $X \in \mathbf{H}$ equipped with a \mathbf{BA} -2-bundle (an A -bundle gerbe) modulated by a map $\phi_X : X \rightarrow \mathbf{B}^2 A$. A field $(\sigma, \eta) : \phi_X \rightarrow \mathbf{c}$ in $\mathbf{H}/\mathbf{B}^2 A$ is a choice σ of a G -principal bundle on X together with an equivalence $\eta : \sigma^* \mathbf{c} \xrightarrow{\simeq} \phi_X$.

Of particular relevance for physics is of course the example of this which is given by the Spin-extension of the special orthogonal group

$$\mathbf{B}\mathbb{Z}_2 \longrightarrow \mathbf{BSpin} \xrightarrow{\mathbf{SpinStruc}} \mathbf{BSO} \xrightarrow{\mathbf{w}_2} \mathbf{B}^2 \mathbb{Z}_2 ,$$

which is classified by the universal second Stiefel-Whitney class \mathbf{w}_2 . (From now on we notationally suppress, for convenience, the dimension n when displaying these groups.) For $o_X : X \rightarrow \mathbf{BSO}$ an orientation structure on a manifold X , a map

$$o_X \longrightarrow \mathbf{SpinStruc}$$

in \mathbf{H}/\mathbf{BSO} is equivalently a choice of Spin-structure on o_X . Alternatively, if $\phi : X \longrightarrow \mathbf{B}^2 \mathbb{Z}_2$ is the map modulating a given \mathbb{Z}_2 -2-bundle (\mathbb{Z}_2 -bundle gerbe) over X , then a map $\phi_X \longrightarrow \mathbf{w}_2$ covering o_X is a

ϕ -twisted spin structure on o_X . An important special case of this is where $\phi = \mathbf{c}_1(E) \bmod 2$ is the mod-2 reduction of the Chern class of a given $U(1)$ -principal bundle/complex line bundle on X : a $\mathbf{c}_1(E)$ -twisted spin structure is equivalently a Spin^c -structure on X whose underlying $U(1)$ -principal bundle is E . More generally, E itself is taken to be part of the field content and so we consider the universal Chern-class

$$\mathbf{c}_1 : \mathbf{B}U(1) \longrightarrow \mathbf{B}^2\mathbb{Z}$$

of the universal $U(1)$ -principal bundle. There is a diagram

$$\begin{array}{ccc} \mathbf{B}\text{Spin}^c & \longrightarrow & \mathbf{B}U(1) \\ \text{Spin}^c\text{Struc} \downarrow & & \downarrow \mathbf{c}_1 \bmod 2 \\ \mathbf{B}SO & \xrightarrow{w_2} & \mathbf{B}^2\mathbb{Z}_2 \end{array}$$

in \mathbf{H} which exhibits the moduli stack of Spin^c -principal bundles as the homotopy fiber product of \mathbf{c}_1 with w_2 . With this, maps

$$o_X \longrightarrow \text{Spin}^c\text{Struc}$$

in $\mathbf{H}_{\mathbf{B}SO}$ are equivalently Spin^c -structures on X (for arbitrary underlying $U(1)$ -principal bundle). Notice that the formalism of twist transformations again tells us what the right kind of transformations is along which Spin-structures and Spin^c -structures may be pulled back: these are maps $o_Y \longrightarrow o_X$ in $\mathbf{H}_{\mathbf{B}SO}$ and hence *orientation-preserving* local diffeomorphisms.

All of this is just a low-degree step in a whole tower of *higher Spin-structures* and *higher Spin^c -structure* that appear as fields in the effective higher supergravity theories underlying superstring theory. This tower is the *Whitehead tower* of $\mathbf{B}O$. Its smooth lift through $|-|$ to a tower of higher moduli stacks has been constructed in [FSS10] (an interpreted in physics as discussed now in [SSS09c], reviewed in the broader context of cohesive ∞ -toposes in section 4 here):

$$\begin{array}{ccc} \vdots & & \\ \mathbf{B}\text{Fivebrane} & & \\ \text{FivebraneStruc} \downarrow & & \\ \mathbf{B}\text{String} & \xrightarrow{\frac{1}{6}p_2} & \mathbf{B}^7U(1) \\ \text{StringStruc} \downarrow & & \\ \mathbf{B}\text{Spin} & \xrightarrow{\frac{1}{2}p_1} & \mathbf{B}^3U(1) \\ \text{SpinStruc} \downarrow & & \\ \mathbf{B}SO & \xrightarrow{w_2} & \mathbf{B}^2\mathbb{Z}_2 \\ \text{OrientStruc} \downarrow & & \\ \mathbf{B}O & \xrightarrow{w_1} & \mathbf{B}\mathbb{Z}_2 \\ \text{OrthStruc} \downarrow & & \\ \mathbf{B}GL & & \end{array}$$

All of these structures can be further twisted. For instance we have the higher analog of Spin^c given by the

delooping 2-group of the homotopy fiber product

$$\begin{array}{ccc}
 \mathbf{B}\text{String}^{c_2} & \longrightarrow & \mathbf{B}(E_8 \times E_8) \\
 \text{String}^{c_2}\text{Struc} \downarrow & & \downarrow c_2 \\
 \mathbf{B}\text{Spin} & \xrightarrow{\frac{1}{2}\mathbf{p}_1} & \mathbf{B}^3U(1)
 \end{array}$$

of $\frac{1}{2}\mathbf{p}_1$ with the smooth universal second Chern class $c_2 : \mathbf{B}(E_8 \times E_8) \longrightarrow \mathbf{B}^3U(1)$. On manifolds X equipped with a Spin-structure $s_X : X \rightarrow \mathbf{B}\text{Spin}$, a field

$$s_X \longrightarrow \text{String}^{c_2}\text{Struc}$$

in $\mathbf{H}/\mathbf{B}\text{Spin}$ is a choice of String^{c_2} -structure, equivalently a choice of $(E_8 \times E_8)$ -principal bundle and an equivalence between its Chern-Simons circle 3-bundle and the Chern-Simons circle 3-bundle of the Spin-structure. This is the quantum-anomaly-free instanton sector of a gauge field in the effective heterotic supergravity underlying the heterotic string [SSS09c]. Below in 1.2.12.3 we discuss how the differential refinement of String^{c_2} -structures capture the dynamical field of gravity and the gauge field in heterotic supergravity.

In summary, the specialization of the diagram of 1.2.12.1 to the anomaly-free instanton-sector of heterotic supergravity looks as follows.

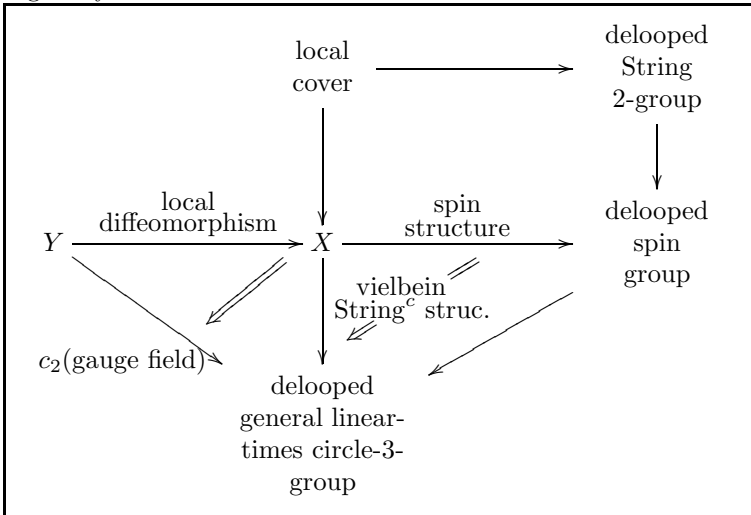

There are further variants of all these examples and other further cases of gravity-like fields in physics given by maps in slice toposes. But for the present discussion we leave it at this and now turn to the other fundamental kind of fields in physics besides gravity: gauge fields.

1.2.12.3 Gauge fields: higher, twisted, non-abelian The other major kind of (quantum) fields besides the (generalized) fields of gravity that we discussed above are of course *gauge fields*. A seminal result of Dirac's old argument about electric/magnetic *charge quantization* is that a configuration of the plain *electromagnetic field* is mathematically a *connection* on a $U(1)$ -principal bundle. Similarly the Yang-Mills field of quantum chromodynamics is mathematically a connection on a G -principal bundle, where G is the corresponding gauge group. The connection itself is locally the *gauge potential* traditionally denoted A , while the class of the underlying global bundle is the *magnetic background charge* for the case of electromagnetism and is the *instanton sector* for the case of $G = \text{SU}(n)$.

Analogously, it has long been known that the background B -field to which the string couples is mathematically a connection on a $U(1)$ -principal *2-bundle* (often presented as $U(1)$ -bundle gerbe), hence a bundle that is principal under the higher group (2-group) $\mathbf{B}U(1)$. Together with the case of ordinary $U(1)$ -principal

bundles these are the first two (or three) degrees of what are known as cocycles in *ordinary differential cohomology*, a refinement of cocycles modulated in the coefficient stack $\mathbf{B}^n U(1)$ by *curvature twists* controlled by smooth differential form data. A general formalization of this based on the underlying topological classifying spaces $K(\mathbb{Z}, n+1) \simeq |\mathbf{B}^n U(1)|$, or in fact any infinite loop space $|\mathbf{B}\mathbb{G}|$ representing a generalized cohomology theory, has been given in [HoSi05]. Here we refine this construction to the cohesive higher topos case and obtain higher cohesive moduli stacks $\mathbf{B}\mathbb{G}_{\text{conn}}$ such that maps $X \rightarrow \mathbf{B}\mathbb{G}_{\text{conn}}$ with coefficients in these are differential \mathbb{G} -cocycles and hence equivalently (higher) *gauge fields* on X for the (higher, cohesive) gauge group \mathbb{G} .

An ∞ -group $\mathbb{G} \in \text{Grp}(\mathbf{H})$ is *abelian* or E_∞ if it is equipped with an n -fold delooping $\mathbf{B}^n \mathbb{G} \in \mathbf{H}$ for all $n \in \mathbb{N}$. If it is equipped at least with a second delooping $\mathbf{B}^2 \mathbb{G}$, then we say it is a *braided ∞ -group*. Equivalently this means that the single delooping object $\mathbf{B}\mathbb{G}$ is itself equipped with the structure of an ∞ -group. For example the full subcategory of any braided monoidal ∞ -category on the objects that are invertible under the tensor product is a braided ∞ -group, hence the name.

For a braided ∞ -group \mathbb{G} in a cohesive ∞ -topos, the axioms of cohesion induce a canonical map

$$\text{curv}_{\mathbb{G}} : \mathbf{B}\mathbb{G} \longrightarrow \mathfrak{b}_{\text{dR}} \mathbf{B}^2 \mathbb{G}$$

to the *de Rham coefficient objects* of the group $\mathbf{B}\mathbb{G}$. On the one hand this may be interpreted as the *Maurer-Cartan form* on the cohesive group $\mathbf{B}\mathbb{G}$. Equivalently, one finds that this is the *universal curvature characteristic* of \mathbb{G} -principal ∞ -bundles: the map can be seen to proceed by equipping a \mathbb{G} -principal ∞ -bundle with a *pseudo-connection* and then sending that to the corresponding curvature in the de Rham hypercohomology with coefficients in the ∞ -Lie algebra of \mathbb{G} .

In order to pick among those (higher) pseudo-connections with curvature in hypercohomology those that are genuine (higher) connections characterized by having globally well defined curvature differential form data, let $\Omega_{\text{cl}}(-, \mathbb{G}) \in \mathbf{H}$ be a 0-truncated object equipped with a map $\Omega_{\text{cl}}(-, \mathbb{G}) \longrightarrow \mathfrak{b}_{\text{dR}} \mathbf{B}^2 \mathbb{G}$ which has the following property: for every manifold Σ the induced map

$$[\Sigma, \Omega_{\text{cl}}(-, \mathbb{G})] \longrightarrow [\Sigma, \mathfrak{b}_{\text{dR}} \mathbf{B}^2 \mathbb{G}]$$

is 1-epimorphism (an effective epimorphism, hence an epimorphism in the sheaf topos under 0-truncation). This expresses the fact that $\Omega_{\text{cl}}(-, \mathbb{G})$ is a sheaf of flat $\text{Lie}(\mathbb{G})$ -valued differential forms, in that every de Rham cohomology class over a manifold is represented by such a form.

(More generally one considers a suitable filtration $\Omega_{\text{cl}}^\bullet(-, \mathbb{G}) \longrightarrow \mathfrak{b}_{\text{dR}} \mathbf{B}^2 \mathbb{G}$, hence a kind of *universal mixed Hodge structure on \mathbb{G} -cohomology*).

Then the moduli object $\mathbf{B}\mathbb{G}_{\text{conn}}$ for *differential \mathbb{G} -cocycles* is the homotopy pullback in

$$\begin{array}{ccc} \mathbf{B}\mathbb{G}_{\text{conn}} & \longrightarrow & \Omega_{\text{cl}}^n(-) \\ \downarrow & & \downarrow \\ \mathbf{B}\mathbb{G} & \xrightarrow{\text{curv}_{\mathbb{G}}} & \mathfrak{b}_{\text{dR}} \mathbf{B}^2 \mathbb{G} \end{array} .$$

For example if $\mathbb{G} \simeq \mathbf{B}^{n-1} U(1)$ in smooth ∞ -groupoids, then the object $\mathbf{B}^n U(1)_{\text{conn}}$ defined this way is the n -stack which is presented under the Dold-Kan correspondence by the *Deligne-complex* of sheaves. It modulates ordinary differential cohomology.

A configuration of the electromagnetic field on a space X is a map $X \rightarrow \mathbf{B}U(1)_{\text{conn}}$. A configuration of the B -field background gauge field of the bosonic string is a map $X \rightarrow \mathbf{B}^2 U(1)_{\text{conn}}$. (For the superstring the situation is a bit more refined, discussed below.) A configuration of the C -field background gauge field of M -theory involves (among other data) a map $X \rightarrow \mathbf{B}^3 U(1)_{\text{conn}}$.

Differential T-duality and B_n -geometry

Above we have seen that the *extended* Lagrangian $\mathbf{L} : \mathbf{B}G_{\text{conn}} \rightarrow \mathbf{B}^3 U(1)_{\text{conn}}$ for $G = \text{Spin}, \text{SU}$ -Chern-Simons 3d gauge field theory also serves as the twist that defines the moduli stack $\mathbf{B}\text{String}_{\text{conn}}^{c_2}$ of Green-Schwarz anomaly-free heterotic background gauge field configurations. In view of this it is natural to ask:

does the extended Lagrangian of $U(1)$ -Chern-Simons theory similarly play a role as part of the background gauge field structure for superstrings? Indeed this turns out to be the case: the extended $U(1)$ -Chern-Simons Lagrangian encodes the twist that defines *differential T-duality structures* and B_n -geometry.

To see this, we observe by direct inspection that what in [KaVa10] is called a *differential T-duality structure* on a pair of circle-bundles $S^1 \rightarrow X_1, X_2 \rightarrow Y$ over some base Y and equipped with connections ∇_1 and ∇_2 , is a trivialization of the corresponding cup-product circle 3-bundle, hence of the extended Chern-Simons Lagrangian of two-species $U(1)$ -Chern-Simons theory pulled back along the map that modulates the two circle bundles.

We now say this again in more detail. Let T^1 be a circle and $\tilde{T}^1 := \text{Hom}(T^1, U(1))$ the dual circle, with the canonical pairing denoted $\langle -, - \rangle : T^1 \times \tilde{T}^1 \rightarrow U(1)$. Then the first spacetime $X_1 \rightarrow Y$ is modulated by a map $\mathbf{c}_1 : Y \longrightarrow \mathbf{B}T^1_{\text{conn}}$, and its T-dual $\tilde{c}_1 : X_2 \rightarrow Y$ by a map $\tilde{\mathbf{c}}_1 : Y \rightarrow \mathbf{B}\tilde{T}^1_{\text{conn}}$.

Now the pairing and the cup product together form a universal characteristic map of moduli stacks

$$\langle - \cup - \rangle : \mathbf{B}(T^1 \times \tilde{T}^1) \longrightarrow \mathbf{B}^3U(1) .$$

By the above discussion, this has a differential refinement

$$\langle - \cup - \rangle : \mathbf{B}(T^1 \times \tilde{T}^1)_{\text{conn}} \longrightarrow \mathbf{B}^3U(1)_{\text{conn}}$$

which is the extended Lagrangian of $U(1)$ -Chern-Simons theory in 3d. If instead we regard the same map as a 3-cocycle, it modulates a higher group extension $\text{String}(T^1 \times \tilde{T}^1) \rightarrow T^1 \times \tilde{T}^1$, sitting in a long fiber sequence of higher moduli stacks of the form

$$\dots \longrightarrow \mathbf{B}U(1) \longrightarrow \text{String}(T^1 \times \tilde{T}^1) \longrightarrow (T^1 \times \tilde{T}^1) \longrightarrow \mathbf{B}^2U(1) \longrightarrow \mathbf{B}\text{String}(T^1 \times \tilde{T}^1) \longrightarrow \mathbf{B}(T^1 \times \tilde{T}^1) \longrightarrow \mathbf{B}^3$$

One sees from this that a *differential T-duality structure* on (X_1, X_2) as considered in def. 2.1 of [KaVa10] is equivalently – when refined to the context of smooth higher geometry – a lift of $(\mathbf{c}_1, \tilde{\mathbf{c}}_1)$ through the left vertical projection in the homotopy pullback square

$$\begin{array}{ccc} \mathbf{B}\text{String}(T^1 \times \tilde{T}^1)_{\text{conn}} & \longrightarrow & \Omega_{\text{cl}}^{4 \leq \bullet \leq 3} \\ \downarrow & & \downarrow \\ \mathbf{B}(T^1 \times \tilde{T}^1)_{\text{conn}} & \xrightarrow{\langle - \cup - \rangle} & \mathbf{B}^3U(1)_{\text{conn}} \end{array} ,$$

hence is a map in the slice over $\mathbf{B}^3U(1)_{\text{conn}}$, hence is a *differential* $\text{String}(T^1 \times \tilde{T}^1)$ -structure on the given data. Along the lines of the discussion in [FSS10] one finds, as for the twisted differential String-structures discussed above, that such a lift locally corresponds to a choice of 3-form H satisfying

$$d_{\text{dR}}H = \langle F_{A_1} \wedge F_{A_2} \rangle ,$$

where A_1, A_2 are the local connection forms of the two circle bundles. This is the local structure that has been referred to as B_n -geometry, see the corresponding discussion and references given in [FSS12c].

Observe that by the universal property of homotopy fibers, the underlying trivialization of the cup product circle 3-bundle corresponds to a choice of factorization of $(\mathbf{c}_1, \tilde{\mathbf{c}}_1)$ as shown on the bottom of the following diagram

$$\begin{array}{ccccc} X_1 \times_Y X_2 & \xrightarrow{\kappa} & \mathbf{B}^2U(1) & \longrightarrow & * \\ \downarrow & & \downarrow & & \downarrow \\ Y & \longrightarrow & \mathbf{B}\text{String}(T^1 \times \tilde{T}^1) & \longrightarrow & \mathbf{B}(T^1 \times \tilde{T}^1) \end{array} .$$

Forming the consecutive homotopy pullback of the point inclusion as given by these two squares, the map $X_1 \times_Y X_2 \rightarrow \mathbf{B}^2U(1)$ induced by the universal property of the homotopy pullback modulates a circle 2-bundle ($U(1)$ -bundle gerbe) on the correspondence space. This is the bundle gerbe on the correspondence space considered in 2.2, 2.3 of [KaVa10]. Notice that this is just a special case of the general phenomenon of twisted higher bundles, as laid out in [NSS12a].

1.2.12.4 Gauge invariance, equivariance and general covariance The notion of *gauge transformation* and *gauge invariance* is built right into higher geometry. Any object $X \in \mathbf{H}$ in general contains not just (local) points, but also gauge equivalences between these, gauge-of-gauge equivalences between those, and so on. A map $\exp(iS(-)) : \mathbf{Fields} \rightarrow U(1)$ is automatically a *gauge invariant function* with respect to whatever gauge transformations the species of fields encoded by the moduli object \mathbf{Fields} encodes.

Specifically, if an ∞ -group G acts on some Y , then a *G-equivariance* structure on a map $Y \rightarrow A$ is an extension

$$\begin{array}{ccc} Y & \xrightarrow{\quad} & A \\ \downarrow & \dashrightarrow & \\ Y//G & & \end{array}$$

along the canonical quotient projection.

If A here is a 0-truncated object such that $U(1)$, then the existence of such an extension is just a property. But if A has itself gauge equivalences, say if $A = \mathbf{B}^nU(1)_{\text{conn}}$ for positive n -then a choice of such an extension is genuine extra structure. For $n = 1$ this is the familiar structure on an *equivariant bundle*. For higher n it is a suitable higher order generalization of this notion.

Equivariance is preserved by transgression. If $\mathbf{L} : \mathbf{Fields} \rightarrow \mathbf{B}^nU(1)_{\text{conn}}$ is an extended Lagrangian, hence equivalently a equivariant n -connection on the space of fields, then for Σ_k any object the mapping space $[\Sigma_k, \mathbf{Fields}]$ contains the gauge equivalences of the given field species on Σ and accordingly the transgressed Lagrangian

$$\exp(2\pi i \int_{\Sigma_k} [\Sigma_k, \mathbf{L}]) : [\Sigma_k, \mathbf{Fields}] \rightarrow \mathbf{B}^{n-k}U(1)_{\text{conn}}$$

is gauge invariant (precisely: carries gauge-equivariant structure).

A particular kind of gauge equivalence/equivariance is the *diffeomorphism equivariance* of a *generally covariant field theory*. In such a field theory two fields $\phi_1, \phi_2 : \Sigma \rightarrow \mathbf{Fields}$ are to be regarded as gauge equivalent if there is a diffeomorphism, hence an automorphism $\alpha : \Sigma \xrightarrow{\sim} \Sigma$ in \mathbf{H} , such that $\alpha^*\phi_2 \simeq \phi_1$.

Formally this means that for generally covariant field theories the field space $[\Sigma, \mathbf{Fields}]$ over a given worldvolume Σ is to be formed in the slice $\mathbf{H}/_{\mathbf{BAut}(\Sigma)} \simeq \mathbf{Aut}(\Sigma)\text{Act}$, with Σ understood as equipped with the defining $\mathbf{Aut}(\Sigma)$ -action and with \mathbf{Fields} equipped with the trivial $\mathbf{Aut}(\Sigma)$ -action, we write

$$[\Sigma, \mathbf{Fields}]_{/\mathbf{BAut}(\Sigma)} \in \mathbf{H}/_{\mathbf{BAut}(\Sigma)}$$

for emphasis. To see this one observes that generally for $(V_1, \rho_1), (V_2, \rho_2) \in \mathbf{GAct}$ two objects equipped with G -action, their mapping space $[V_1, V_2]_{/\mathbf{BG}}$ formed in the slice is the absolute mapping space $[V_1, V_2]$ formed in \mathbf{H} and equipped with the *conjugation action* of G , under which an element $g \in G$ acts on an element $f : V_1 \rightarrow V_2$ by sending it to $\rho_2(g)^{-1} \circ f \circ \rho_1(g)$.

Hence the mapping space $[\Sigma, \mathbf{Fields}]_{/\mathbf{BAut}(\Sigma)}$ formed in the slice corresponds in \mathbf{H} to the fiber sequence

$$\begin{array}{ccc} \Sigma & \longrightarrow & \mathbf{Aut}(\Sigma) \backslash \backslash [\Sigma, \mathbf{Fields}] \\ & & \downarrow \\ & & \mathbf{BAut}(\Sigma) \end{array}$$

and a *generally covariant field theory* for the given species of fields is one whose configuration spaces are $\mathbf{Aut}(\Sigma) \backslash \backslash [\Sigma, \mathbf{Fields}]$, the action groupoids of the ∞ -groupoid of field configurations on Σ by the diffeomorphism action on Σ .

Ordinary 3d Chern-Simons theory is strictly speaking to be regarded as a generally covariant field theory, but this is often not made explicit, due to a special property of 3d Chern-Simons theory: if two *on-shell* field configurations are related by a diffeomorphism (connected to the identity), then they are already gauge equivalent also by a gauge transformation in $[\Sigma, \mathbf{BG}_{\text{conn}}]$. This holds in fact also for all higher Chern-Simons theories that come from *binary* invariant polynomials, but it does not hold fully generally. Even when this is the case, suppressing the general covariance is a dubious move, since while the gauge equivalence classes may coincide, $\tau_0[\Sigma, \mathbf{Fields}]_{\text{onshell}} \simeq \tau_0 \mathbf{Aut}(\Sigma) \backslash \backslash [\Sigma, \mathbf{Fields}]_{\text{onshell}}$, the two full homotopy types still need not be equivalent and hence the corresponding quantum field theories may not be equivalent.

1.2.13 Variational calculus on higher moduli stacks of fields

Traditionally, the *phase space* of a physical system which is given by an action functional $\exp(iS) : \mathbf{Fields}(\Sigma) \longrightarrow U(1)$ is the *variational critical locus* of $\exp(iS)$: the subspace of field configurations $\mathbf{Fields}(\Sigma)$ on some manifold Σ with boundary, such that the variation $\mathbf{d}S$ of the action (with fields on $\partial\Sigma$ held fixed) vanishes when restricted to this subspace. One also calls this the space of solutions of the *Euler-Lagrange equations* of the system. Often one considers the special case where $\Sigma = \Sigma_{\text{in}} \times [0, 1]$ is the cylinder over a closed manifold Σ_{in} and under suitable conditions on S , solutions to the Euler-Lagrange equations are fixed by their value and first derivative on Σ_{in} , in which case the phase space may be identified with the cotangent bundle $T^*\mathbf{Field}(\Sigma_{\text{in}})$. This simple special case is sometimes regarded as the definition of the notion of phase space, and in order to distinguish the general notion from this special case one calls the space of solutions of the Euler-Lagrange equations also the *covariant phase space*. For S a local action functional this space is canonically equipped with a pre-symplectic form. Quotienting out the (gauge) symmetries makes this a genuine symplectic form on what is called the *reduced phase space*. But as with all quotients, this quotient makes good sense in general only when formed in a suitable homotopy-theoretic sense, hence in higher geometry. The physics literature knows a formalism for dealing with this as the *BV-BRST formalism*.

In the following we discuss these issues in differential cohesive higher geometry, for the prequantum theory of n -dimensional field theories defined by extended Lagrangians $\mathbf{L} : \mathbf{Fields} \longrightarrow \mathbf{B}^n U(1)_{\text{conn}}$, which induce action functionals as above after transgression to the mapping space out of some Σ .

Let $\mathbb{G} \in \text{Grp}(\mathbf{H})$ be a cohesive ∞ -group. By the discussion in 1.2.12.3 above there is a canonical de Rham cocycle on \mathbb{G} , the ∞ -Maurer-Cartan form

$$\theta : \mathbb{G} \longrightarrow \mathfrak{b}_{\text{dR}} \mathbf{B}\mathbb{G} .$$

A little reflection shows that in the context of higher stacks, this form is also the *universal differential* for \mathbb{G} -valued functions, in that for

$$S : X \longrightarrow \mathbb{G}$$

any map, the composite

$$S^{-1} \mathbf{d}S : X \xrightarrow{S} \mathbb{G} \xrightarrow{\theta} \mathfrak{b}_{\text{dR}} \mathbf{B}\mathbb{G}$$

which corresponds to a $\text{Lie}(\mathbb{G})$ -valued differential cocycle on X , is the normalized differential of S .

If here $X = \mathbf{Fields}(\Sigma)$ is a space of fields on some manifold Σ with boundary $\partial\Sigma \hookrightarrow \Sigma$, then the *variational differential* is the restriction of this differential to variations which keep the field configurations over the boundary $\partial\Sigma$ fixed. This restriction is given by precomposition with the top horizontal morphism in the following homotopy pullback diagram

$$\begin{array}{ccc} \mathbf{Fields}(\Sigma)_{\partial\Sigma} & \xrightarrow{\iota} & \mathbf{Fields}(\Sigma) \ . \\ \downarrow & & \downarrow \\ \mathfrak{b}\mathbf{Fields}(\partial\Sigma) & \longrightarrow & \mathbf{Fields}(\partial\Sigma) \end{array}$$

Here $\flat : \mathbf{H} \rightarrow \mathbf{H}$ is the *flat modality* given by the cohesion of \mathbf{H} . In summary, the *variational differential* of a map $S : \mathbf{Fields} \longrightarrow \mathbb{G}$ is the composite

$$S^{-1}\mathbf{d}_{\text{var}}S : \mathbf{Fields}(\Sigma)_{\partial\Sigma} \xrightarrow{\iota} \mathbf{Fields}(\Sigma) \xrightarrow{S} \mathbb{G} \xrightarrow{\theta} \flat_{\text{dR}}\mathbf{BG} .$$

Now the *phase space* or *variational critical locus* or *solution space of the Euler-Lagrange equations* of S is supposed to be the subobject of $\mathbf{Fields}(\Sigma)_{\partial\Sigma}$ “on which this differential vanishes”. But one needs to be careful with how to interpret this. For instance the differential vanishes when the whole expression above is restricted to any point $* \rightarrow \mathbf{Fields}(\Sigma)_{\partial\Sigma}$, simply because any de Rham data on the point is trivial: there is only an essentially unique map $* \longrightarrow \flat_{\text{dR}}\mathbf{BG}$: the 0-form. Therefore, what should really be meant by a point where the differential vanishes is a point such that the differential vanishes *on every infinitesimal neighbourhood* of it.

In other words, when testing whether $S^{-1}\mathbf{d}_{\text{var}}S$ vanishes when restricted to a subspace $\phi : U \hookrightarrow \mathbf{Fields}(\Sigma)_{\partial\Sigma}$, we need to ensure that U is *infinitesimally spread out* or *infinitesimally open* in $\mathbf{Fields}(\Sigma)$. Such a *spread-out map* ϕ is commonly known by the French term as an *étale map*; and an *infinitesimally spread out* map is known as a *formally étale map* (with “formal” as in “formal power series” rings, which are the rings of functions on the infinitesimal neighbourhood of the origin in a linear space).

The differential cohesion of the ambient ∞ -topos canonically induces a notion of such formally étale maps: the *infinitesimal path modality* $\mathbf{\Pi}_{\text{inf}} : \mathbf{H} \longrightarrow \mathbf{H}$ sends an object X to what is sometimes called its *de Rham space* $\mathbf{\Pi}_{\text{inf}}(X)$, in which infinitesimally close points are made equivalent. There is a natural inclusion $X \longrightarrow \mathbf{\Pi}_{\text{inf}}(X)$ which may alternatively be thought of as the inclusion of the constant paths in X into the infinitesimal paths in X , or as the quotient map that quotients out the infinitesimal neighbourhood relation.

Now, a map $f : X \longrightarrow Y$ is *formally étale* if the naturality square of this inclusion

$$\begin{array}{ccc} X & \longrightarrow & \mathbf{\Pi}_{\text{inf}}(X) \\ \downarrow f & & \downarrow \mathbf{\Pi}_{\text{inf}}(f) \\ Y & \longrightarrow & \mathbf{\Pi}_{\text{inf}}(Y) \end{array}$$

is a homotopy pullback square. This is a generalization to cohesive ∞ -groupoids of the traditional fact that a map f between smooth manifolds is a *local diffeomorphism* precisely if the square of tangent bundle projections

$$\begin{array}{ccc} TX & \longrightarrow & X \\ \downarrow df & & \downarrow f \\ TY & \longrightarrow & Y \end{array}$$

is a pullback diagram of smooth manifolds. (To see how the general condition above relates to this one, let $D \hookrightarrow \mathbb{R}$ be the first order infinitesimal neighbourhood of the origin in the real line and observe that $X^D \simeq TX$, $f^D \simeq df$, but that $(\mathbf{\Pi}_{\text{inf}}(X))^D \simeq \mathbf{\Pi}_{\text{inf}}(X)$.)

For any object $X \in \mathbf{H}$ we then have the ∞ -category

$$\text{Sh}_{\mathbf{H}}(X) := (\mathbf{H}_{/X}) \xleftarrow{\text{Et}} \mathbf{H}_{/X}$$

of formally étale maps into X . As the notation on the left indicates, this may be thought of as the *petit ∞ -topos of ∞ -sheaves on X* , in generalization of the classical fact of topos theory which identifies sheaves on a topological space with étale topological spaces over it.

The inclusion of formally étale maps into the entire slice ∞ -topos $\mathbf{H}_{/X}$ (the *gros ∞ -topos* of X) has a right adjoint reflector Et , as indicated above. This induces for any object $A \in \mathbf{H}$ the ∞ -sheaf on X of *A-valued functions on X* :

$$\mathcal{O}_X(A) := \text{Et}(X \times A \xrightarrow{p_1} X) \in \text{Sh}_{\mathbf{H}}(X) .$$

In particular, for \mathbb{G} as above we have the ∞ -sheaf

$$\mathcal{O}_X(\flat_{\mathrm{dR}}\mathbf{B}\mathbb{G}) \in \mathrm{Sh}_{\mathbf{H}}(X)$$

of flat $\mathrm{Lie}(\mathbb{G})$ -valued differential forms on X . The 0-section $0 : * \rightarrow \flat_{\mathrm{dR}}\mathbf{B}\mathbb{G}$ induces a 0-section

$$0 : X \rightarrow \mathcal{O}_X(\flat_{\mathrm{dR}}\mathbf{B}\mathbb{G})$$

in $\mathrm{Sh}_{\mathbf{H}}(X)$, and more generally any map $\omega : X \longrightarrow \flat_{\mathrm{dR}}\mathbf{B}\mathbb{G}$ induces a section

$$\omega : X \rightarrow \mathcal{O}_X(\flat_{\mathrm{dR}}\mathbf{B}\mathbb{G})$$

in $\mathrm{Sh}_{\mathbf{H}}(X)$.

But now since in $\mathrm{Sh}_{\mathbf{H}}(X)$ every subspace $U \hookrightarrow X$ is guaranteed to be formally étale, this is the right context to solve the Euler-Lagrange equations of an action functional: we say that the *critical locus* of $S : \mathbf{Fields}(\Sigma)_{\partial\Sigma} \longrightarrow \mathbb{G}$ is the homotopy fiber

$$\sum_{\phi \in \mathbf{Fields}(\Sigma)_{\partial\Sigma}} (S^{-1}(\phi) \mathbf{d}_{\mathrm{var}} S(\phi) \simeq 0) \in \mathrm{Sh}_{\mathbf{H}}(\mathbf{Fields}(\Sigma)_{\partial\Sigma}),$$

sitting in the homotopy pullback square

$$\begin{array}{ccc} \sum_{\phi \in \mathbf{Fields}(\Sigma)_{\partial\Sigma}} (S^{-1}(\phi) \mathbf{d}_{\mathrm{var}} S(\phi) \simeq 0) & \longrightarrow & \mathbf{Fields}(\Sigma)_{\partial\Sigma} \\ \downarrow & & \downarrow 0 \\ \mathbf{Fields}(\Sigma)_{\partial\Sigma} & \xrightarrow{S^{-1} \mathbf{d}_{\mathrm{var}} S} & \mathcal{O}_{\mathbf{Fields}(\Sigma)_{\partial\Sigma}}(\flat_{\mathrm{dR}}\mathbf{B}\mathbb{G}) \end{array}$$

in $\mathrm{Sh}_{\mathbf{H}}(\mathbf{Fields}(\Sigma)_{\partial\Sigma})$.

This critical locus is known in traditional literature for the special case that $\mathbb{G} = \mathbb{R}$ is the additive Lie group of real numbers and in its *infinitesimal* approximation: the ∞ -Lie algebroid of the critical locus is known, dually as the *on-shell BRST complex* of the system (whereas the ∞ -Lie algebroid of $\mathbf{Fields}(\Sigma)$ itself is the *off-shell BRST complex*). Moreover, if the ambient ∞ -topos \mathbf{H} is not 1-localic, and specifically if it has a site of definition given by formal duals of simplicial (smooth) algebras, then the critical locus as above is also called the *derived critical locus* for emphasis, and its ∞ -Lie algebroid is dually known as the *BV-BRST complex* of the system. (For discussion of how the traditional formulation of BV-BRST complexes models homotopy pullbacks of the above form see [Sc11].)

But with the general notion of critical loci in cohesive ∞ -toposes, we obtain examples beyond those discussed in the literature whenever \mathbb{G} is a *higher* group.

Notably when $\mathbb{G} := \mathbf{B}^n U(1)$ is the circle $(n+1)$ -group, then the universal differential

$$\theta : \mathbf{B}^n U(1) \longrightarrow \flat_{\mathrm{dR}}\mathbf{B}^{n+1}U(1)$$

is equivalently, by the discussion in 1.2.12.3, the *universal curvature characteristic* for smooth circle n -bundles, and so there are accordingly higher order interpretations of phase spaces in *extended* prequantization.

For example, let $\mathbf{c} : \mathbf{B}G \longrightarrow \mathbf{B}^n U(1)$ be a universal characteristic map on the moduli stack of a cohesive ∞ -group G . Then

$$S := p_1 \circ [\mathbf{\Pi}(S^1), \mathbf{c}] : G //_{\mathrm{ad}} G \longrightarrow \mathbf{B}^{n-1}U(1) //_{\mathrm{ad}} \mathbf{B}^{n-1}U(1) \longrightarrow \mathbf{B}^{n-1}U(1)$$

is the WZW- $(n-1)$ -bundle (equipped with its ad-equivariant structure) of the corresponding n -dimensional Chern-Simons theory. Regarding this as a \mathbb{G} -valued function, we find that its variational differential

$$S^{-1} \mathbf{d}_{\mathrm{var}} S : G //_{\mathrm{ad}} G \xrightarrow{S} \mathbf{B}^{n-1}U(1) \xrightarrow{\theta} \flat_{\mathrm{dR}}\mathbf{B}^n U(1)$$

is the curvature, in de Rham hypercohomology, of the WZW- $(n-1)$ -bundle.

1.2.14 Higher geometric prequantum theory

We had indicated in section 1.2.15 how a single extended Lagrangian, given by a map of universal higher moduli stacks $\mathbf{L} : \mathbf{B}G_{\text{conn}} \rightarrow \mathbf{B}^n U(1)_{\text{conn}}$, induces, by transgression, circle $(n - k)$ -bundles with connection

$$\text{hol}_{\Sigma_k} \mathbf{Maps}(\Sigma_k, \mathbf{L}) : \mathbf{Maps}(\Sigma_k, \mathbf{B}G_{\text{conn}}) \longrightarrow \mathbf{B}^{n-k} U(1)_{\text{conn}}$$

on moduli stacks of field configurations over each closed k -manifold Σ_k . In codimension 1, hence for $k = n - 1$, this reproduces the ordinary *prequantum circle bundle* of the n -dimensional Chern-Simons type theory, as discussed in section 1.2.15.1.3. The space of sections of the associated line bundle is the space of *prequantum states* of the theory. This becomes the space of genuine quantum states after choosing a *polarization* (i.e., a decomposition of the moduli space of fields into *canonical coordinates* and *canonical momenta*) and restricting to polarized sections (i.e., those depending only on the canonical coordinates). But moreover, for each Σ_k we may regard $\text{hol}_{\Sigma_k} \mathbf{Maps}(\Sigma_k, \mathbf{L})$ as a *higher prequantum bundle* of the theory in higher codimension and hence consider its prequantum geometry in higher codimension.

We discuss now some generalities of such a higher geometric prequantum theory and then show how this perspective sheds a useful light on the gauge coupling of the open string, as part of the transgression of prequantum 2-states of Chern-Simons theory in codimension 2 to prequantum states in codimension 1.

We indicate now the basic concepts of higher extended prequantum theory and how they reproduce traditional prequantum theory.

Consider a (pre)- n -plectic form, given by a map

$$\omega : X \longrightarrow \Omega^{n+1}(-; \mathbb{R})_{\text{cl}}$$

in \mathbf{H} . A *n-plectomorphism* of (X, ω) is an auto-equivalence of ω regarded as an object in the slice $\mathbf{H}/_{\Omega_{\text{cl}}^{n+1}}$, hence a diagram of the form

$$\begin{array}{ccc} X & \xrightarrow{\simeq} & X \\ & \searrow \omega & \swarrow \omega \\ & \Omega^{n+1}(-; \mathbb{R})_{\text{cl}} & \end{array} .$$

A *prequantization* of (X, ω) is a choice of prequantum line bundle, hence a choice of lift ∇ in

$$\begin{array}{ccc} & \mathbf{B}^n U(1)_{\text{conn}} & \\ & \nearrow \nabla & \downarrow F_{(-)} \\ X & \xrightarrow{\omega} & \Omega_{\text{cl}}^{n+1} \end{array} ,$$

modulating a circle n -bundle with connection on X . We write $\mathbf{c}(\nabla) : X \xrightarrow{\nabla} \mathbf{B}^n U(1)_{\text{conn}} \rightarrow \mathbf{B}^n U(1)$ for the underlying $(\mathbf{B}^{n-1} U(1))$ -principal n -bundle. An autoequivalence

$$\hat{O} : \nabla \xrightarrow{\simeq} \nabla$$

of the prequantum n -bundle regarded as an object in the slice $\mathbf{H}/_{\mathbf{B}^n U(1)_{\text{conn}}}$, hence a diagram in \mathbf{H} of the form

$$\begin{array}{ccc} X & \xrightarrow{\simeq} & X \\ & \searrow \nabla & \swarrow \nabla \\ & \mathbf{B}^n U(1)_{\text{conn}} & \end{array}$$

\hat{O}

is an (exponentiated) *prequantum operator* or *quantomorphism* or *regular contact transformation* of the prequantum geometry (X, ∇) , forming an ∞ -group in \mathbf{H} . The L_∞ -algebra of this *quantomorphism* ∞ -group

is the higher *Poisson bracket* Lie algebra of the system. If X is equipped with abelian group structure then the quantomorphisms covering these translations form the *Heisenberg ∞ -group*. The homotopy labeled O above diagram is the *Hamiltonian* of the prequantum operator. The image of the quantomorphisms in the symplectomorphisms (given by composition the above diagram with the curvature morphism $F_{(-)} : \mathbf{B}^n U(1)_{\text{conn}} \rightarrow \Omega_{\text{cl}}^{n+1}$) is the group of *Hamiltonian n -plectomorphisms*. A lift of an ∞ -group action $G \rightarrow \mathbf{Aut}(X)$ on X from automorphisms of X (diffeomorphism) to quantomorphisms is a *Hamiltonian action*, infinitesimally (and dually) a *momentum map*.

To define higher prequantum states we fix a representation (V, ρ) of the circle n -group $\mathbf{B}^{n-1}U(1)$. By the general results in [NSS12a] this is equivalent to fixing a homotopy fiber sequence of the form

$$\begin{array}{ccc} \underline{V} & \longrightarrow & \underline{V} // \mathbf{B}^{n-1}U(1) \\ & & \downarrow \rho \\ & & \mathbf{B}^n U(1) \end{array}$$

in \mathbf{H} . The vertical morphism here is the *universal ρ -associated V -fiber ∞ -bundle* and characterizes ρ itself. Given such, a section of the V -fiber bundle which is ρ -associated to $\mathbf{c}(\nabla)$ is equivalently a map

$$\Psi : \mathbf{c}(\nabla) \longrightarrow \rho$$

in the slice $\mathbf{H}/_{\mathbf{B}^n U(1)}$. This is a higher *prequantum state* of the prequantum geometry (X, ∇) . Since every prequantum operator \hat{O} as above in particular is an auto-equivalence of the underlying prequantum bundle $\hat{O} : \mathbf{c}(\nabla) \xrightarrow{\sim} \mathbf{c}(\nabla)$ it canonically acts on prequantum states given by maps as above simply by precomposition

$$\Psi \mapsto \hat{O} \circ \Psi .$$

Notice also that from the perspective of section 5.2.1 all this has an equivalent interpretation in terms of twisted cohomology: a prequantum state is a cocycle in twisted V -cohomology, with the twist being the prequantum bundle. And a prequantum operator/quantomorphism is equivalently a twist automorphism (or “generalized local diffeomorphism”).

For instance if $n = 1$ then ω is an ordinary (pre)symplectic form and ∇ is the connection on a circle bundle. In this case the above notions of prequantum operators, quantomorphism group, Heisenberg group and Poisson bracket Lie algebra reproduce exactly all the traditional notions if X is a smooth manifold, and generalize them to the case that X is for instance an orbifold or even itself a higher moduli stack, as we have seen. The canonical representation of the circle group $U(1)$ on the complex numbers yields a homotopy fiber sequence

$$\begin{array}{ccc} \underline{\mathbb{C}} & \longrightarrow & \underline{\mathbb{C}} // U(1) \\ & & \downarrow \rho \\ & & \mathbf{B}U(1) \end{array} ,$$

where $\underline{\mathbb{C}} // U(1)$ is the stack corresponding to the ordinary action groupoid of the action of $U(1)$ on \mathbb{C} , and where the vertical map is the canonical functor forgetting the data of the local \mathbb{C} -valued functions. This is the *universal complex line bundle* associated to the universal $U(1)$ -principal bundle. One readily checks that a prequantum state $\Psi : \mathbf{c}(\nabla) \rightarrow \rho$, hence a diagram of the form

$$\begin{array}{ccc} X & \xrightarrow{\sigma} & \underline{\mathbb{C}} // U(1) \\ & \searrow \mathbf{c}(\nabla) & \swarrow \rho \\ & & \mathbf{B}U(1) \end{array}$$

in \mathbf{H} is indeed equivalently a section of the complex line bundle canonically associated to $\mathbf{c}(\nabla)$ and that under this equivalence the pasting composite

$$\begin{array}{ccccc}
 X & \xrightarrow{\cong} & X & \longrightarrow & \mathbb{C} // \underline{U}(1) \\
 & \searrow & \downarrow \mathbf{c}(\nabla) & \swarrow \rho & \\
 & & \mathbf{B}U(1) & &
 \end{array}$$

is the result of the traditional formula for the action of the prequantum operator \hat{O} on Ψ .

Instead of forgetting the connection on the prequantum bundle in the above composite, one can equivalently equip the prequantum state with a differential refinement, namely with its *covariant derivative* and then exhibit the prequantum operator action directly. Explicitly, let $\mathbb{C} // \underline{U}(1)_{\text{conn}}$ denote the quotient stack $(\mathbb{C} \times \Omega^1(-, \mathbb{R})) // \underline{U}(1)$, with $U(1)$ acting diagonally. This sits in a homotopy fiber sequence

$$\begin{array}{ccc}
 \mathbb{C} & \longrightarrow & \mathbb{C} // \underline{U}(1)_{\text{conn}} \\
 & & \downarrow \rho_{\text{conn}} \\
 & & \mathbf{B}U(1)_{\text{conn}}
 \end{array}$$

which may be thought of as the differential refinement of the above fiber sequence $\mathbb{C} \rightarrow \mathbb{C} // \underline{U}(1) \rightarrow \mathbf{B}U(1)$. (Compare this to section 1.2.15.1.5, where we had similarly seen the differential refinement of the fiber sequence $\underline{G} / \underline{T}_\lambda \rightarrow \mathbf{B}T_\lambda \rightarrow \mathbf{B}G$, which analogously characterizes the canonical action of G on the coset space G/T_λ .) Prequantum states are now equivalently maps

$$\hat{\Psi} : \nabla \longrightarrow \rho_{\text{conn}}$$

in $\mathbf{H} / \mathbf{B}U(1)_{\text{conn}}$. This formulation realizes a section of an associated line bundle equivalently as a connection on what is sometimes called a groupoid bundle. As such, $\hat{\Psi}$ has not just a 2-form curvature (which is that of the prequantum bundle) but also a 1-form curvature: this is the covariant derivative $\nabla\sigma$ of the section.

Such a relation between sections of higher associated bundles and higher covariant derivatives holds more generally. In the next degree for $n = 2$ one finds that the quantomorphism 2-group is the Lie 2-group which integrates the *Poisson bracket Lie 2-algebra* of the underlying 2-plectic geometry as introduced in [Rog11a]. In the next section we look at an example for $n = 2$ in more detail and show how it interplays with the above example under transgression.

The above higher prequantum theory becomes a genuine quantum theory after a suitable higher analog of a choice of *polarization*. In particular, for $\mathbf{L} : X \rightarrow \mathbf{B}^n U(1)_{\text{conn}}$ an extended Lagrangian of an n -dimensional quantum field theory as discussed in all our examples here, and for Σ_k any closed manifold, the polarized prequantum states of the transgressed prequantum bundle $\text{hol}_{\Sigma_k} \mathbf{Maps}(\Sigma_k, \mathbf{L})$ should form the $(n - k)$ -vector spaces of higher quantum states in codimension k . These states would be assigned to Σ_k by the *extended quantum field theory*, in the sense of [L-TFT], obtained from the extended Lagrangian \mathbf{L} by extended geometric quantization. There is an equivalent reformulation of this last step for $n = 1$ given simply by the push-forward of the prequantum line bundle in K-theory (see section 6.8 of [GGK02]) and so one would expect that accordingly the last step of higher geometric quantization involves similarly a push-forward of the associated V -fiber ∞ -bundles above in some higher generalized cohomology theory. But this remains to be investigated.

1.2.15 Examples of higher prequantum field theories

We consider now some examples of the higher geometric prequantum field theory discussed above.

- 1.2.15.1 – Extended 3d Chern-Simons theory
- 1.2.15.2 – The anomaly-free gauge coupling of the open string

1.2.15.1 Extended 3d Chern-Simons theory For G a simply connected compact simple Lie group, the above construction of the refined Chern-Weil homomorphism yields a differential characteristic map of moduli stacks

$$\hat{\mathbf{c}} : \mathbf{B}G_{\text{conn}} \quad \mathbf{B}^3U(1)_{\text{conn}}$$

which is the smooth and differential refinement of the universal characteristic class $[c] \in H^4(BG, \mathbb{Z})$.

We discuss now how this serves as the *extended* Lagrangian for 3d Chern-Simons theory in that its *transgression* to mapping stacks out of k -dimensional manifolds yields all the “geometric prequantum” data of Chern-Simons theory in the corresponding dimension, in the sense of geometric quantization. For the purpose of this exposition we use terms such as “prequantum n -bundle” freely without formal definition. We expect the reader can naturally see at least vaguely the higher prequantum picture alluded to here. A more formal survey of these notions is in section 1.2.12.

The following paragraphs draw from [FSS13a].

If X is a compact oriented manifold without boundary, then there is a fiber integration in differential cohomology lifting fiber integration in integral cohomology [HoSi05]:

$$\begin{array}{ccc} \hat{H}^{n+\dim X}(X \times Y; \mathbb{Z}) & \xrightarrow{f_X} & \hat{H}^n(Y; \mathbb{Z}) \\ \downarrow & & \downarrow \\ H^{n+\dim X}(X \times Y; \mathbb{Z}) & \xrightarrow{f_X} & H^n(Y; \mathbb{Z}) . \end{array}$$

In [GoTe00] Gomi and Terashima describe an explicit lift of this at the level of Čech-Deligne cocycles. Such a lift has a natural interpretation as a morphism

$$\text{hol}_X : \mathbf{Maps}(X, \mathbf{B}^{n+\dim X}U(1)_{\text{conn}}) \rightarrow \mathbf{B}^nU(1)_{\text{conn}}$$

from the $(n + \dim X)$ -stack of moduli of $U(1)$ - $(n + \dim X)$ -bundles with connection over X to the n -stack of $U(1)$ - n -bundles with connection, 4.4.16. Therefore, if Σ_k is a compact oriented manifold of dimension k with $0 \leq k \leq 3$, we have a composition

$$\mathbf{Maps}(\Sigma_k, \mathbf{B}G_{\text{conn}}) \xrightarrow{\mathbf{Maps}(\Sigma_k, \hat{\mathbf{c}})} \mathbf{Maps}(\Sigma_k, \mathbf{B}^3U(1)_{\text{conn}}) \xrightarrow{\text{hol}_{\Sigma_k}} \mathbf{B}^{3-k}U(1)_{\text{conn}} .$$

This is the canonical $U(1)$ - $(3 - k)$ -bundle with connection over the moduli space of principal G -bundles with connection over Σ_k induced by $\hat{\mathbf{c}}$: the *transgression* of $\hat{\mathbf{c}}$ to the mapping space. Composing on the right with the curvature morphism we get the underlying canonical closed $(4 - k)$ -form

$$\mathbf{Maps}(\Sigma_k, \mathbf{B}G_{\text{conn}}) \rightarrow \Omega^{4-k}(-; \mathbb{R})_{\text{cl}}$$

on this moduli space. In other words, the moduli stack of principal G -bundles with connection over Σ_k carries a canonical *pre-(3 - k)-plectic structure* (the higher order generalization of a symplectic structure, [Rog11a]) and, moreover, this is equipped with a canonical geometric prequantization: the above $U(1)$ - $(3 - k)$ -bundle with connection.

Let us now investigate in more detail the cases $k = 0, 1, 2, 3$.

1.2.15.1.1 $k = 0$: the universal Chern-Simons 3-connection $\hat{\mathbf{c}}$ The connected 0-manifold Σ_0 is the point and, by definition of \mathbf{Maps} , one has a canonical identification

$$\mathbf{Maps}(*, \mathbf{S}) \cong \mathbf{S}$$

for any (higher) stack \mathbf{S} . Hence the morphism

$$\mathbf{Maps}(*, \mathbf{B}G_{\text{conn}}) \xrightarrow{\mathbf{Maps}(*, \hat{\mathbf{c}})} \mathbf{Maps}(*, \mathbf{B}^3U(1)_{\text{conn}})$$

is nothing but the universal differential characteristic map $\hat{c} : \mathbf{B}G_{\text{conn}} \rightarrow \mathbf{B}^3U(1)_{\text{conn}}$ that refines the universal characteristic class c . This map modulates a circle 3-bundle with connection (bundle 2-gerbe) on the universal moduli stack of G -principal connections. For $\nabla : X \rightarrow \mathbf{B}G_{\text{conn}}$ any given G -principal connection on some X , the pullback

$$\hat{c}(\nabla) : X \xrightarrow{\nabla} \mathbf{B}G_{\text{conn}} \xrightarrow{\hat{c}} \mathbf{B}^3U(1)_{\text{conn}}$$

is a 3-bundle (bundle 2-gerbe) on X which is sometimes in the literature called the *Chern-Simons 2-gerbe* of the given connection ∇ . Accordingly, \hat{c} modulates the *universal* Chern-Simons bundle 2-gerbe with universal 3-connection. From the point of view of higher geometric quantization, this is the *prequantum 3-bundle* of extended prequantum Chern-Simons theory.

This means that the prequantum $U(1)$ -(3 - k)-bundles associated with k -dimensional manifolds are all determined by the prequantum $U(1)$ -3-bundle associated with the point, in agreement with the formulation of fully extended topological field theories [FHLT09]. We will denote by the symbol $\omega_{\mathbf{B}G_{\text{conn}}}^{(4)}$ the pre-3-plectic 4-form induced on $\mathbf{B}G_{\text{conn}}$ by the curvature morphism.

1.2.15.1.2 $k = 1$: the Wess-Zumino-Witten gerbe We now come to the transgression of the extended Chern-Simons Lagrangian to the closed connected 1-manifold, the circle $\Sigma_1 = S^1$. Notice that, on the one hand, we can think of the mapping stack $\mathbf{Maps}(\Sigma_1, \mathbf{B}G_{\text{conn}}) \simeq \mathbf{Maps}(S^1, \mathbf{B}G_{\text{conn}})$ as a kind of moduli stack of G -connections on the circle – up to the subtlety of differential concretification discussed in 3.9.6.4. On the other hand, we can think of that mapping stack as the *free loop space* of the universal moduli stack $\mathbf{B}G_{\text{conn}}$.

The subtlety here is related to the differential refinement, so it is instructive to first discard the differential refinement and consider just the smooth characteristic map $\mathbf{c} : \mathbf{B}G \rightarrow \mathbf{B}^3U(1)$ which underlies the extended Chern-Simons Lagrangian and which modulates the universal circle 3-bundle on $\mathbf{B}G$ (without connection). Now, for every pointed stack $* \rightarrow \mathbf{S}$ we have the corresponding (categorical) *loop space* $\Omega\mathbf{S} := * \times_{\mathbf{S}} *$, which is the homotopy pullback of the point inclusion along itself. Applied to the moduli stack $\mathbf{B}G$ this recovers the Lie group G , identified with the sheaf (i.e, the 0-stack) of smooth functions with target G : $\Omega\mathbf{B}G \simeq \underline{G}$. This kind of looping/delooping equivalence is familiar from the homotopy theory of classifying spaces; but notice that since we are working with smooth (higher) stacks, the loop space $\Omega\mathbf{B}G$ also knows the smooth structure of the group G , i.e. it knows G as a Lie group. Similarly, we have

$$\Omega\mathbf{B}^3U(1) \simeq \mathbf{B}^2U(1)$$

and so forth in higher degrees. Since the looping operation is functorial, we may also apply it to the characteristic map \mathbf{c} itself to obtain a map

$$\Omega\mathbf{c} : \underline{G} \rightarrow \mathbf{B}^2U(1)$$

which modulates a $\mathbf{B}U(1)$ -principal 2-bundle on the Lie group G . This is also known as the *WZW-bundle gerbe*; see for instance [ScWa]. The reason, as discussed there and as we will see in a moment, is that this is the 2-bundle that underlies the 2-connection with surface holonomy over a worldsheet given by the Wess-Zumino-Witten action functional. However, notice first that there is more structure implied here: by the discussion in 4.4.4.2, for any pointed stack \mathbf{S} there is a natural equivalence $\Omega\mathbf{S} \simeq \mathbf{Maps}_*(\mathbf{II}(S^1), \mathbf{S})$, between the loop space object $\Omega\mathbf{S}$ and the moduli stack of *pointed maps* from the categorical circle $\mathbf{II}(S^1) \simeq \mathbf{B}\mathbb{Z}$ to \mathbf{S} . On the other hand, if we do not fix the base point then we obtain the *free loop space object* $\mathcal{L}\mathbf{S} \simeq \mathbf{Maps}(\mathbf{II}(S^1), \mathbf{S})$. Since a map $\mathbf{II}(\Sigma) \rightarrow \mathbf{B}G$ is equivalently a map $\Sigma \rightarrow \mathfrak{b}\mathbf{B}G$, i.e., a flat G -principal connection on Σ , the free loop space $\mathcal{L}\mathbf{B}G$ is equivalently the moduli stack of flat G -principal connections on S^1 . We will come back to this perspective in section 3.9.6.4 below. The homotopies that do not fix the base point act by conjugation on loops and hence we have, for any smooth (higher) group, that

$$\mathcal{L}\mathbf{B}G \simeq \underline{G} //_{\text{Ad}} \underline{G}$$

is the (homotopy) quotient of the adjoint action of G on itself; see [NSS12a] for details on homotopy actions of smooth higher groups. For G a Lie group this is the familiar adjoint action quotient stack. But the expression holds fully generally. Notably, we also have

$$\mathcal{L}\mathbf{B}^3U(1) \simeq \mathbf{B}^2U(1) //_{\text{Ad}} \mathbf{B}^2U(1)$$

and so forth in higher degrees. However, in this case, since the smooth 3-group $\mathbf{B}^2U(1)$ is abelian (it is a groupal E_∞ -algebra) the adjoint action splits off in a direct factor and we have a projection

$$\mathcal{L}\mathbf{B}^3U(1) \simeq \mathbf{B}^2U(1) \times (* // \mathbf{B}^2U(1)) \xrightarrow{p_1} \mathbf{B}^2U(1) .$$

In summary, this means that the map $\Omega\mathbf{c}$ modulating the WZW 2-bundle over G descends to the adjoint quotient to the map

$$p_1 \circ \mathcal{L}\mathbf{c} : \underline{G} //_{\text{Ad}} \underline{G} \rightarrow \mathbf{B}^2U(1) ,$$

and this means that the WZW 2-bundle is canonically equipped with the structure of an ad_G -equivariant bundle gerbe, a crucial feature of the WZW bundle gerbe.

We emphasize that the derivation here is fully general and holds for any smooth (higher) group G and any smooth characteristic map $\mathbf{c} : \mathbf{B}G \rightarrow \mathbf{B}^nU(1)$. Each such pair induces a WZW-type $(n - 1)$ -bundle on the smooth (higher) group G modulated by $\Omega\mathbf{c}$ and equipped with G -equivariant structure exhibited by $p_1 \circ \mathcal{L}\mathbf{c}$. We discuss such higher examples of higher Chern-Simons-type theories with their higher WZW-type functionals further below in section 5.5.2.

We now turn to the differential refinement of this situation. In analogy to the above construction, but taking care of the connection data in the extended Lagrangian $\hat{\mathbf{c}}$, we find a homotopy commutative diagram in \mathbf{H} of the form

$$\begin{array}{ccccc} \mathbf{Maps}(S^1; \mathbf{B}G_{\text{conn}}) & \xrightarrow{\mathbf{Maps}(S^1, \hat{\mathbf{c}})} & \mathbf{Maps}(S^1; \mathbf{B}^3U(1)_{\text{conn}}) & & \\ \text{hol} \downarrow & & \downarrow \text{hol} & & \\ \underline{G} & \longrightarrow & \underline{G} //_{\text{Ad}} \underline{G} & \xrightarrow{\mathbf{wzw}} & \mathbf{B}^2U(1)_{\text{conn}} //_{\text{Ad}} \mathbf{B}^2U(1)_{\text{conn}} \longrightarrow \mathbf{B}^2U(1)_{\text{conn}} , \end{array}$$

where the vertical maps are obtained by forming holonomies of (higher) connections along the circle. The lower horizontal row is the differential refinement of $\Omega\mathbf{c}$: it modulates the Wess-Zumino-Witten $U(1)$ -bundle gerbe with connection

$$\mathbf{wzw} : \underline{G} \rightarrow \mathbf{B}^2U(1)_{\text{conn}} .$$

That \mathbf{wzw} is indeed the correct differential refinement can be seen, for instance, by interpreting the construction by Carey-Johnson-Murray-Stevenson-Wang in [CJMSW05] in terms of the above diagram. That is, choosing a basepoint x_0 in S^1 one obtains a canonical lift of the leftmost vertical arrow:

$$\begin{array}{ccc} & \mathbf{Maps}(S^1; \mathbf{B}G_{\text{conn}}) & \\ (P_{x_0}, \nabla_{x_0}) \nearrow & & \downarrow \text{hol} \\ \underline{G} & \longrightarrow & \underline{G} //_{\text{Ad}} \underline{G} , \end{array}$$

where (P_{x_0}, ∇_{x_0}) is the principal G -bundle with connection on the product $G \times S^1$ characterized by the property that the holonomy of ∇_{x_0} along $\{g\} \times S^1$ with starting point (g, x_0) is the element g of G . Correspondingly, we have a homotopy commutative diagram

$$\begin{array}{ccccc} \mathbf{Maps}(S^1; \mathbf{B}G_{\text{conn}}) & \xrightarrow{\mathbf{Maps}(S^1, \hat{\mathbf{c}})} & \mathbf{Maps}(S^1; \mathbf{B}^3U(1)_{\text{conn}}) & & \\ (P_{x_0}, \nabla_{x_0}) \nearrow & \text{hol} \downarrow & \downarrow \text{hol} & \searrow \text{hol}_{S^1} & \\ \underline{G} & \longrightarrow & \underline{G} //_{\text{Ad}} \underline{G} & \xrightarrow{\mathbf{wzw}} & \mathbf{B}^2U(1)_{\text{conn}} //_{\text{Ad}} \mathbf{B}^2U(1)_{\text{conn}} \longrightarrow \mathbf{B}^2U(1)_{\text{conn}} . \end{array}$$

Then Proposition 3.4 from [CJMSW05] identifies the upper path (and hence also the lower path) from \underline{G} to $\mathbf{B}^2U(1)_{\text{conn}}$ with the Wess-Zumino-Witten bundle gerbe.

Passing to equivalence classes of global sections, we see that \mathbf{wzw} induces, for any smooth manifold X , a natural map $C^\infty(X; G) \rightarrow \hat{H}^2(X; \mathbb{Z})$. In particular, if $X = \Sigma_2$ is a compact Riemann surface, we can further integrate over X to get

$$wzw : C^\infty(\Sigma_2; G) \rightarrow \hat{H}^2(X; \mathbb{Z}) \xrightarrow{\int_{\Sigma_2}} U(1) .$$

This is the *topological term* in the Wess-Zumino-Witten model; see [Ga88, FrWi99, CJM02]. Notice how the fact that \mathbf{wzw} factors through $\underline{G} //_{\text{Ad}} \underline{G}$ gives the conjugation invariance of the Wess-Zumino-Witten bundle gerbe, and hence of the topological term in the Wess-Zumino-Witten model.

1.2.15.1.3 $k = 2$: Symplectic structure on the moduli of flat connections For Σ_2 a compact Riemann surface, the transgression of the extended Lagrangian $\hat{\mathbf{c}}$ yields a map

$$\mathbf{Maps}(\Sigma_2; \mathbf{B}G_{\text{conn}}) \xrightarrow{\mathbf{Maps}(\Sigma_2, \hat{\mathbf{c}})} \mathbf{Maps}(\Sigma_2; \mathbf{B}^3U(1)_{\text{conn}}) \xrightarrow{\text{hol}_{\Sigma_2}} \mathbf{BU}(1)_{\text{conn}} ,$$

modulating a circle-bundle with connection on the moduli space of gauge fields on Σ_2 . The underlying curvature of this connection is the map obtained by composing this with

$$\mathbf{BU}(1)_{\text{conn}} \xrightarrow{F_{(-)}} \Omega^2(-; \mathbb{R})_{\text{cl}} ,$$

which gives the canonical pre-symplectic 2-form

$$\omega : \mathbf{Maps}(\Sigma_2; \mathbf{B}G_{\text{conn}}) \longrightarrow \Omega^2(-; \mathbb{R})_{\text{cl}}$$

on the moduli stack of principal G -bundles with connection on Σ_2 . Equivalently, this is the transgression of the invariant polynomial $\langle - \rangle : \mathbf{B}G_{\text{conn}} \longrightarrow \Omega_{\text{cl}}^4$ to the mapping stack out of Σ_2 . The restriction of this 2-form to the moduli stack $\mathbf{Maps}(\Sigma_2; \mathfrak{b}\mathbf{B}G_{\text{conn}})$ of flat principal G -bundles on Σ_2 induces a canonical symplectic structure on the moduli space

$$\text{Hom}(\pi_1(\Sigma_2), G) /_{\text{Ad}} G$$

of flat G -bundles on Σ_2 . Such a symplectic structure was identified as the phase space structure of Chern-Simons theory in [Wi98c].

To see more explicitly what this form ω is, consider any test manifold $U \in \text{CartSp}$. Over this the map of stacks ω is a function which sends a G -principal connection $A \in \Omega^1(U \times \Sigma_2)$ (using that every G -principal bundle over $U \times \Sigma_2$ is trivializable) to the 2-form

$$\int_{\Sigma_2} \langle F_A \wedge F_A \rangle \in \Omega^2(U) .$$

Now if A represents a field in the phase space, hence an element in the concretification of the mapping stack, then it has no “leg”⁵ along U , and so it is a 1-form on Σ_2 that depends smoothly on the parameter U : it is a U -parameterized *variation* of such a 1-form. Accordingly, its curvature 2-form splits as

$$F_A = F_A^{\Sigma_2} + d_U A ,$$

where $F_A^{\Sigma_2} := d_{\Sigma_2} A + \frac{1}{2}[A \wedge A]$ is the U -parameterized collection of curvature forms on Σ_2 . The other term is the *variational differential* of the U -collection of forms. Since the fiber integration map $\int_{\Sigma_2} : \Omega^4(U \times \Sigma_2) \rightarrow$

⁵That is, when written in local coordinates (u, σ) on $U \times \Sigma_2$, then $A = A_i(u, \sigma) du^i + A_j(u, \sigma) d\sigma^j$ reduces to the second summand.

$\Omega^2(U)$ picks out the component of $\langle F_A \wedge F_A \rangle$ with two legs along Σ_2 and two along U , integrating over the former we have that

$$\omega|_U = \int_{\Sigma_2} \langle F_A \wedge F_A \rangle = \int_{\Sigma_2} \langle d_U A \wedge d_U A \rangle \in \Omega_{\text{cl}}^2(U).$$

In particular if we consider, without loss of generality, $(U = \mathbb{R}^2)$ -parameterized variations and expand

$$d_U A = (\delta_1 A) du^1 + (\delta_2 A) du^2 \in \Omega^2(\Sigma_2 \times U),$$

then

$$\omega|_U = \int_{\Sigma_2} \langle \delta_1 A, \delta_2 A \rangle.$$

In this form the symplectic structure appears, for instance, in prop. 3.17 of part I of [Fr95] (in [Wi97b] this corresponds to (3.2)).

In summary, this means that the circle bundle with connection obtained by transgression of the extended Lagrangian \hat{c} is a *geometric prequantization* of the phase space of 3d Chern-Simons theory. Observe that traditionally prequantization involves an arbitrary *choice*: the choice of prequantum bundle with connection whose curvature is the given symplectic form. Here we see that in *extended* prequantization this choice is eliminated, or at least reduced: while there may be many differential cocycles lifting a given curvature form, only few of them arise by transgression from a higher differential cocycles in top codimension. In other words, the restrictive choice of the single geometric prequantization of the invariant polynomial $\langle -, - \rangle : \mathbf{BG}_{\text{conn}} \rightarrow \Omega_{\text{cl}}^4$ by $\hat{c} : \mathbf{BG}_{\text{conn}} \rightarrow \mathbf{B}^3 U(1)_{\text{conn}}$ down in top codimension induces canonical choices of prequantization over all Σ_k in all lower codimensions $(n - k)$.

1.2.15.1.4 $k = 3$: the Chern-Simons action functional Finally, for Σ_3 a compact oriented 3-manifold without boundary, transgression of the extended Lagrangian \hat{c} produces the morphism

$$\mathbf{Maps}(\Sigma_3; \mathbf{BG}_{\text{conn}}) \xrightarrow{\mathbf{Maps}(\Sigma_3, \hat{c})} \mathbf{Maps}(\Sigma_3; \mathbf{B}^3 U(1)_{\text{conn}}) \xrightarrow{\text{hol}_{\Sigma_3}} \underline{U}(1).$$

Since the morphisms in $\mathbf{Maps}(\Sigma_3; \mathbf{BG}_{\text{conn}})$ are *gauge transformations* between field configurations, while $\underline{U}(1)$ has no non-trivial morphisms, this map necessarily gives a *gauge invariant* $U(1)$ -valued function on field configurations. Indeed, evaluating over the point and passing to isomorphism classes (and hence to gauge equivalence classes), this induces the *Chern-Simons action functional*

$$S_{\hat{c}} : \{G\text{-bundles with connection on } \Sigma_3\} / \text{iso} \rightarrow U(1).$$

It follows from the description of \hat{c} that if the principal G -bundle $P \rightarrow \Sigma_3$ is trivialisable then

$$S_{\hat{c}}(P, \nabla) = \exp 2\pi i \int_{\Sigma_3} \text{CS}_3(A),$$

where $A \in \Omega^1(\Sigma_3, \mathfrak{g})$ is the \mathfrak{g} -valued 1-form on Σ_3 representing the connection ∇ in a chosen trivialization of P . This is actually always the case, but notice two things: first, in the stacky description one does not need to know a priori that every principal G -bundle on a 3-manifold is trivialisable; second, the independence of $S_{\hat{c}}(P, \nabla)$ on the trivialization chosen is automatic from the fact that $S_{\hat{c}}$ is a morphism of stacks read at the level of equivalence classes.

Furthermore, if (P, ∇) can be extended to a principal G -bundle with connection $(\tilde{P}, \tilde{\nabla})$ over a compact 4-manifold Σ_4 bounding Σ_3 , one has

$$S_{\hat{c}}(P, \nabla) = \exp 2\pi i \int_{\Sigma_4} \tilde{\varphi}^* \omega_{\mathbf{BG}_{\text{conn}}}^{(4)} = \exp 2\pi i \int_{\Sigma_4} \langle F_{\tilde{\nabla}}, F_{\tilde{\nabla}} \rangle,$$

where $\tilde{\varphi} : \Sigma_4 \rightarrow \mathbf{BG}_{\text{conn}}$ is the morphism corresponding to the extended bundle $(\tilde{P}, \tilde{\nabla})$. Notice that the right hand side is independent of the extension chosen. Again, this is always the case, so one can actually

take the above equation as a definition of the Chern-Simons action functional, see, e.g., [Fr95]. However, notice how in the stacky approach we do not need a priori to know that the oriented cobordism ring is trivial in dimension 3. Even more remarkably, the stacky point of view tells us that there would be a natural and well-defined 3d Chern-Simons action functional even if the oriented cobordism ring were nontrivial in dimension 3 or that not every G -principal bundle on a 3-manifold were trivializable. An instance of checking a nontrivial higher cobordism group vanishes can be found in [KS05], allowing for the application of the construction of Hopkins-Singer [HoSi05].

1.2.15.1.5 The Chern-Simons action functional with Wilson loops To conclude our exposition of the examples of 1d and 3d Chern-Simons theory in higher geometry, we now briefly discuss how both unify into the theory of 3d Chern-Simons gauge fields with Wilson line defects. Namely, for every embedded knot

$$\iota : S^1 \hookrightarrow \Sigma_3$$

in the closed 3d worldvolume and every complex linear representation $R : G \rightarrow \text{Aut}(V)$ one can consider the *Wilson loop observable* $W_{\iota,R}$ mapping a gauge field $A : \Sigma \rightarrow \mathbf{BG}_{\text{conn}}$, to the corresponding “Wilson loop holonomy”

$$W_{\iota,R} : A \mapsto \text{tr}_R(\text{hol}(\iota^* A)) \in \mathbb{C}.$$

This is the trace, in the given representation, of the parallel transport defined by the connection A around the loop ι (for any choice of base point). It is an old observation⁶ that this Wilson loop $W(C, A, R)$ is itself the *partition function* of a 1-dimensional topological σ -model quantum field theory that describes the topological sector of a particle charged under the nonabelian background gauge field A . In section 3.3 of [Wi97b] it was therefore emphasized that Chern-Simons theory with Wilson loops should really be thought of as given by a single Lagrangian which is the sum of the 3d Chern-Simons Lagrangian for the gauge field as above, plus that for this topologically charged particle.

We now briefly indicate how this picture is naturally captured by higher geometry and refined to a single *extended Lagrangian* for coupled 1d and 3d Chern-Simons theory, given by maps on higher moduli stacks. In doing this, we will also see how the ingredients of Kirillov’s orbit method and the Borel-Weil-Bott theorem find a natural rephrasing in the context of smooth differential moduli stacks. The key observation is that for $\langle \lambda, - \rangle$ an integral weight for our simple, connected, simply connected and compact Lie group G , the contraction of \mathfrak{g} -valued differential forms with λ extends to a morphism of smooth moduli stacks of the form

$$\langle \lambda, - \rangle : \Omega^1(-, \mathfrak{g}) // \underline{T}_\lambda \rightarrow \mathbf{BU}(1)_{\text{conn}},$$

where $T_\lambda \hookrightarrow G$ is the maximal torus of G which is the stabilizer subgroup of $\langle \lambda, - \rangle$ under the coadjoint action of G on \mathfrak{g}^* . Indeed, this is just the classical statement that exponentiation of $\langle \lambda, - \rangle$ induces an isomorphism between the integral weight lattice $\Gamma_{\text{wt}}(\lambda)$ relative to the maximal torus T_λ and the \mathbb{Z} -module $\text{Hom}_{\text{Grp}}(T_\lambda, U(1))$ and that under this isomorphism a gauge transformation of a \mathfrak{g} -valued 1-form A turns into that of the $\mathfrak{u}(1)$ -valued 1-form $\langle \lambda, A \rangle$.

This is the extended Lagrangian of a 1-dimensional Chern-Simons theory. In fact it is just a slight variant of the trace-theory discussed there: if we realize \mathfrak{g} as a matrix Lie algebra and write $\langle \alpha, \beta \rangle = \text{tr}(\alpha \cdot \beta)$ as the matrix trace, then the above Chern-Simons 1-form is given by the “ λ -shifted trace”

$$\text{CS}_\lambda(A) := \text{tr}(\lambda \cdot A) \in \Omega^1(-; \mathbb{R}).$$

Then, clearly, while the “plain” trace is invariant under the adjoint action of all of G , the λ -shifted trace is invariant only under the subgroup T_λ of G that fixes λ .

Notice that the domain of $\langle \lambda, - \rangle$ naturally sits inside $\mathbf{BG}_{\text{conn}}$ by the canonical map

$$\Omega^1(-, \mathfrak{g}) // \underline{T}_\lambda \rightarrow \Omega^1(-, \mathfrak{g}) // \underline{G} \simeq \mathbf{BG}_{\text{conn}}.$$

⁶This can be traced back to [BBS78]; a nice modern review can be found in section 4 of [Be02].

One sees that the homotopy fiber of this map to be the *coadjoint orbit* $\mathcal{O}_\lambda \hookrightarrow \mathfrak{g}^*$ of $\langle \lambda, - \rangle$, equipped with the map of stacks

$$\theta : \mathcal{O}_\lambda \simeq \underline{G} // \underline{T}_\lambda \rightarrow \Omega^1(-, \mathfrak{g}) // \underline{T}_\lambda$$

which over a test manifold U sends $g \in C^\infty(U, G)$ to the pullback $g^* \theta_G$ of the Maurer-Cartan form. Composing this with the above extended Lagrangian $\langle \lambda, - \rangle$ yields a map

$$\langle \lambda, \theta \rangle : \mathcal{O}_\lambda \xrightarrow{\theta} \Omega^1(-, \mathfrak{g}) // \underline{T}_\lambda \xrightarrow{\langle \lambda, - \rangle} \mathbf{BU}(1)_{\text{conn}}$$

which modulates a canonical $U(1)$ -principal bundle with connection on the coadjoint orbit. One finds that this is the canonical prequantum bundle used in the orbit method [Kir04]. In particular its curvature is the canonical symplectic form on the coadjoint orbit.

So far this shows how the ingredients of the orbit method are incarnated in smooth moduli stacks. This now immediately induces Chern-Simons theory with Wilson loops by considering the map $\Omega^1(-, \mathfrak{g}) // \underline{T}_\lambda \rightarrow \mathbf{BG}_{\text{conn}}$ itself as the target⁷ for a field theory defined on knot inclusions $\iota : S^1 \hookrightarrow \Sigma_3$. This means that a field configuration is a diagram of smooth stacks of the form

$$\begin{array}{ccc} S^1 & \xrightarrow{(\iota^* A)^g} & \Omega^1(-, \mathfrak{g}) // \underline{T}_\lambda \\ \downarrow \iota & \swarrow g & \downarrow \\ \Sigma_3 & \xrightarrow{A} & \mathbf{BG}_{\text{conn}} \end{array},$$

i.e., that a field configuration consists of

- a gauge field A in the “bulk” Σ_3 ;
- a G -valued function g on the embedded knot

such that the restriction of the ambient gauge field A to the knot is equivalent, via the gauge transformation g , to a \mathfrak{g} -valued connection on S^1 whose local \mathfrak{g} -valued 1-forms are related each other by local gauge transformations taking values in the torus T_λ . Moreover, a gauge transformation between two such field configurations (A, g) and (A', g') is a pair (t_{Σ_3}, t_{S^1}) consisting of a G -gauge transformation t_{Σ_3} on Σ_3 and a T_λ -gauge transformation t_{S^1} on S^1 , intertwining the gauge transformations g and g' . In particular if the bulk gauge field on Σ_3 is held fixed, i.e., if $A = A'$, then t_{S^1} satisfies the equation $g' = g t_{S^1}$. This means that the Wilson-line components of gauge-equivalence classes of field configurations are naturally identified with smooth functions $S^1 \rightarrow G/T_\lambda$, i.e., with smooth functions on the Wilson loop with values in the coadjoint orbit. This is essentially a rephrasing of the above statement that G/T_λ is the homotopy fiber of the inclusion of the moduli stack of Wilson line field configurations into the moduli stack of bulk field configurations.

We may postcompose the two horizontal maps in this square with our two extended Lagrangians, that for 1d and that for 3d Chern-Simons theory, to get the diagram

$$\begin{array}{ccccc} S^1 & \xrightarrow{(\iota^* A)^g} & \Omega^1(-, \mathfrak{g}) // T & \xrightarrow{\langle \lambda, - \rangle} & \mathbf{BU}(1)_{\text{conn}} \\ \downarrow \iota & \swarrow g & \downarrow & & \\ \Sigma_3 & \xrightarrow{A} & \mathbf{BG}_{\text{conn}} & \xrightarrow{\hat{c}} & \mathbf{B}^3U(1)_{\text{conn}} \end{array}.$$

Therefore, writing $\mathbf{Fields}_{\text{CS+W}} \left(S^1 \xrightarrow{\iota} \Sigma_3 \right)$ for the moduli stack of field configurations for Chern-Simons theory with Wilson lines, we find two action functionals as the composite top and left morphisms in the

⁷This means that here we are secretly moving from the topos of (higher) stacks on smooth manifolds to its *arrow topos*, see section 5.2.1 below.

diagram

$$\begin{array}{ccccc}
\mathbf{Fields}_{\text{CS+W}} \left(S^1 \xrightarrow{\iota} \Sigma_3 \right) & \longrightarrow & \mathbf{Maps}(\Sigma_3, \mathbf{BG}_{\text{conn}}) & \xrightarrow{\text{hol}_{\Sigma_3} \mathbf{Maps}(\Sigma_3, \hat{\mathbf{c}})} & \underline{U}(1) \\
\downarrow & & \downarrow & & \\
\mathbf{Maps}(S^1, \Omega^1(-, \mathfrak{g}) // T_\lambda) & \longrightarrow & \mathbf{Maps}(S^1, \mathbf{BG}_{\text{conn}}) & & \\
\downarrow & & \downarrow & & \\
\text{hol}_{S^1} \mathbf{Maps}(S^1, \langle \lambda, - \rangle) & & & & \\
\downarrow & & & & \\
\underline{U}(1) & & & &
\end{array}$$

in \mathbf{H} , where the top left square is the homotopy pullback that characterizes maps in $\mathbf{H}^{(\Delta^1)}$ in terms of maps in \mathbf{H} . The product of these is the action functional

$$\begin{array}{ccc}
\mathbf{Fields}_{\text{CS+W}} \left(S^1 \xrightarrow{\iota} \Sigma_3 \right) & \longrightarrow & \mathbf{Maps}(\Sigma_3, \mathbf{B}^3 U(1)_{\text{conn}}) \times \mathbf{Maps}(S^1, \mathbf{B}U(1)_{\text{conn}}) \\
& & \downarrow \\
& & \underline{U}(1) \times \underline{U}(1) \longrightarrow \underline{U}(1) .
\end{array}$$

where the rightmost arrow is the multiplication in $U(1)$. Evaluated on a field configuration with components (A, g) as just discussed, this is

$$\exp \left(2\pi i \left(\int_{\Sigma_3} \text{CS}_3(A) + \int_{S^1} \langle \lambda, (\iota^* A)^g \rangle \right) \right) .$$

This is indeed the action functional for Chern-Simons theory with Wilson loop ι in the representation R corresponding to the integral weight $\langle \lambda, - \rangle$ by the Borel-Weil-Bott theorem, as reviewed for instance in Section 4 of [Be02].

Apart from being an elegant and concise repackaging of this well-known action functional and the quantization conditions that go into it, the above reformulation in terms of stacks immediately leads to prequantum line bundles in Chern-Simons theory with Wilson loops. Namely, by considering the codimension 1 case, one finds the symplectic structure and the canonical prequantization for the moduli stack of field configurations on surfaces with specified singularities at specified punctures [Wi97b]. Moreover, this is just the first example in a general mechanism of (extended) action functionals with defect and/or boundary insertions. Another example of the same mechanism is the gauge coupling action functional of the open string. This we discuss in section 1.2.15.2 below.

1.2.15.2 The anomaly-free gauge coupling of the open string As another example of the general phenomena of higher prequantum field theory, we close by briefly indicating how the higher prequantum states of 3d Chern-Simons theory in codimension 2 reproduce the *twisted Chan-Paton gauge bundles* of open string backgrounds, and how their transgression to codimension 1 reproduces the cancellation of the Freed-Witten-Kapustin anomaly of the open string. This section draws from [FSS13a].

By the above, the Wess-Zumino-Witten gerbe $\mathbf{wzw} : G \rightarrow \mathbf{B}^2 U(1)_{\text{conn}}$ as discussed in section 1.2.15.1.2 may be regarded as the *prequantum 2-bundle* of Chern-Simons theory in codimension 2 over the circle. Equivalently, if we consider the WZW σ -model for the string on G and take the limiting TQFT case obtained by sending the kinetic term to 0 while keeping only the gauge coupling term in the action, then it is the extended Lagrangian of the string σ -model: its transgression to the mapping space out of a *closed* worldvolume Σ_2 of the string is the topological piece of the exponentiated WZW σ -model action. For Σ_2 with boundary the situation is more interesting, and this we discuss now.

The canonical representation of the 2-group $BU(1)$ is on the complex K-theory spectrum, whose smooth (stacky) refinement is given by $\mathbf{BU} := \varinjlim_n \mathbf{BU}(n)$ in \mathbf{H} . On any component for fixed n the action of the smooth 2-group $\mathbf{BU}(1)$ is exhibited by the long homotopy fiber sequence

$$U(1) \longrightarrow U(n) \rightarrow \mathrm{PU}(n) \longrightarrow \mathbf{BU}(1) \longrightarrow \mathbf{BU}(n) \longrightarrow \mathbf{BPU}(n) \xrightarrow{\mathbf{dd}_n} \mathbf{B}^2U(1)$$

in \mathbf{H} , in that \mathbf{dd}_n is the universal $(\mathbf{BU}(n))$ -fiber 2-bundle which is associated by this action to the universal $(\mathbf{BU}(1))$ -2-bundle.⁸ Using the general higher representation theory in \mathbf{H} as developed in [NSS12a], a local section of the $(\mathbf{BU}(n))$ -fiber prequantum 2-bundle which is \mathbf{dd}_n -associated to the prequantum 2-bundle \mathbf{wzw} , hence a local prequantum 2-state, is, equivalently, a map

$$\Psi : \mathbf{wzw}|_Q \longrightarrow \mathbf{dd}_n$$

in the slice $\mathbf{H}/_{\mathbf{B}^2U(1)}$, where $\iota_Q : Q \hookrightarrow G$ is some subspace. Equivalently (compare with the general discussion in section 5.2.1), this is a map

$$(\Psi, \mathbf{wzw}) : \iota_Q \longrightarrow \mathbf{dd}_n$$

in $\mathbf{H}^{(\Delta^1)}$, hence a diagram in \mathbf{H} of the form

$$\begin{array}{ccc} Q & \xrightarrow{\Psi} & \mathbf{BPU}(n) \\ \downarrow \iota_Q & \swarrow & \downarrow \mathbf{dd}_n \\ G & \xrightarrow{\mathbf{wzw}} & \mathbf{B}^2U(1) . \end{array}$$

One finds that this equivalently modulates a unitary bundle on Q which is *twisted* by the restriction of \mathbf{wzw} to Q as in twisted K-theory (such a twisted bundle is also called a *gerbe module* if \mathbf{wzw} is thought of in terms of bundle gerbes [CBMMS02]). So

$$\mathbf{dd}_n \in \mathbf{H}/_{\mathbf{B}^2U(1)}$$

is the moduli stack for twisted rank- n unitary bundles. As with the other moduli stacks before, one finds a differential refinement of this moduli stack, which we write

$$(\mathbf{dd}_n)_{\mathrm{conn}} : (\mathbf{BU}(n)//\mathbf{BU}(1))_{\mathrm{conn}} \rightarrow \mathbf{B}^2U(1)_{\mathrm{conn}} ,$$

and which modulates twisted unitary bundles with twisted connections (bundle gerbe modules with connection). Hence a differentially refined state is a map $\hat{\Psi} : \mathbf{wzw}|_Q \rightarrow (\mathbf{dd}_n)_{\mathrm{conn}}$ in $\mathbf{H}/_{\mathbf{B}^2U(1)_{\mathrm{conn}}}$; and this is precisely a twisted gauge field on a D-brane Q on which open strings in G may end. Hence these are the *prequantum 2-states* of Chern-Simons theory in codimension 2. Precursors of this perspective of Chan-Paton bundles over D-branes as extended prequantum 2-states can be found in [Sc07, Rog11b].

Notice that by the above discussion, together the discussion in section 5.2.1, an equivalence

$$\hat{O} : \mathbf{wzw} \xrightarrow{\simeq} \mathbf{wzw}$$

in $\mathbf{H}/_{\mathbf{B}^2U(1)_{\mathrm{conn}}}$ has two different, but equivalent, important interpretations:

1. it is an element of the *quantomorphism 2-group* (i.e. the possibly non-linear generalization of the Heisenberg 2-group) of 2-prequantum operators;

⁸ The notion of $(\mathbf{BU}(n))$ -fiber 2-bundle is equivalently that of nonabelian $U(n)$ -gerbes in the original sense of Giraud, see [NSS12a]. Notice that for $n = 1$ this is more general than the notion of $U(1)$ -bundle gerbe: a G -gerbe has structure 2-group $\mathbf{Aut}(\mathbf{B}G)$, but a $U(1)$ -bundle gerbe has structure 2-group only in the left inclusion of the fiber sequence $\mathbf{BU}(1) \hookrightarrow \mathbf{Aut}(\mathbf{BU}(1)) \rightarrow \mathbb{Z}_2$.

2. it is a twist automorphism analogous to the generalized diffeomorphisms for the fields in gravity.

Moreover, such a transformation is locally a structure well familiar from the literature on D-branes: it is locally (on some cover) given by a transformation of the B-field of the form $B \mapsto B + d_{\text{dR}}a$ for a local 1-form a (this is the *Hamiltonian 1-form* in the interpretation of this transformation in higher prequantum geometry) and its prequantum operator action on prequantum 2-states, hence on Chan-Paton gauge fields $\widehat{\Psi} : \mathbf{wz}\mathbf{w} \longrightarrow (\mathbf{d}\mathbf{d}_n)_{\text{conn}}$ (by precomposition) is given by shifting the connection on a twisted Chan-Paton bundle (locally) by this local 1-form a . This local gauge transformation data

$$B \mapsto B + da, \quad A \mapsto A + a,$$

is familiar from string theory and D-brane gauge theory (see e.g. [Po01]). The 2-prequantum operator action $\Psi \mapsto \hat{O}\Psi$ which we see here is the fully globalized refinement of this transformation.

The map $\widehat{\Psi} : (\iota_Q, \mathbf{wz}\mathbf{w}) \rightarrow (\mathbf{d}\mathbf{d}_n)_{\text{conn}}$ above is the gauge-coupling part of the extended Lagrangian of the *open* string on G in the presence of a D-brane $Q \hookrightarrow G$. We indicate what this means and how it works. Note that for all of the following the target space G and background gauge field $\mathbf{wz}\mathbf{w}$ could be replaced by any target space with any circle 2-bundle with connection on it.

The object ι_Q in $\mathbf{H}^{(\Delta^1)}$ is the target space for the open string. The worldvolume of that string is a smooth compact manifold Σ with boundary inclusion $\iota_{\partial\Sigma} : \partial\Sigma \rightarrow \Sigma$, also regarded as an object in $\mathbf{H}^{(\Delta^1)}$. A field configuration of the string σ -model is then a map

$$\phi : \iota_\Sigma \rightarrow \iota_Q$$

in $\mathbf{H}^{(\Delta^1)}$, hence a diagram

$$\begin{array}{ccc} \partial\Sigma & \longrightarrow & Q \\ \iota_{\partial\Sigma} \downarrow & & \downarrow \iota_Q \\ \Sigma & \xrightarrow{\phi} & G \end{array}$$

in \mathbf{H} , hence a smooth function $\phi : \Sigma \rightarrow G$ subject to the constraint that the boundary of Σ lands on the D-brane Q . Postcomposition with the background gauge field $\widehat{\Psi}$ yields the diagram

$$\begin{array}{ccccc} \partial\Sigma & \longrightarrow & Q & \xrightarrow{\widehat{\Psi}} & (\mathbf{B}U(n)//U(1))_{\text{conn}} \\ \iota_{\partial\Sigma} \downarrow & & \downarrow \iota_Q & & \\ \Sigma & \xrightarrow{\phi} & G & \xrightarrow{\mathbf{wz}\mathbf{w}} & \mathbf{B}^2U(1)_{\text{conn}} . \end{array}$$

Comparison with the situation of Chern-Simons theory with Wilson lines in section 1.2.15.1.5 shows that the total action functional for the open string should be the product of the fiber integration of the top composite morphism with that of the bottom composite morphisms. Hence that functional is the product of the surface parallel transport of the $\mathbf{wz}\mathbf{w}$ B-field over Σ with the line holonomy of the twisted Chan-Paton bundle over $\partial\Sigma$.

This is indeed again true, but for more subtle reasons this time, since the fiber integrations here are *twisted* (we discuss this in detail below in 4.4.18): since Σ has a boundary, parallel transport over Σ does not yield a function on the mapping space out of Σ , but rather a section of the line bundle on the mapping space out of $\partial\Sigma$, pulled back to this larger mapping space.

Furthermore, the connection on a twisted unitary bundle does not quite have a well-defined traced holonomy in \mathbb{C} , but rather a well defined traced holonomy up to a coherent twist. More precisely, the transgression of the WZW 2-connection to maps out of the circle as in section 1.2.15 fits into a diagram of

moduli stacks in \mathbf{H} of the form

$$\begin{array}{ccc}
\mathbf{Maps}(S^1, (\mathbf{BU}(n)//\mathbf{BU}(1))_{\text{conn}}) & \xrightarrow{\text{tr hol}_{S^1}} & \underline{\mathbb{C}}//\underline{U}(1)_{\text{conn}} \\
\downarrow \mathbf{Maps}(S^1, (\mathbf{dd}_n)_{\text{conn}}) & & \downarrow \\
\mathbf{Maps}(S^1, \mathbf{B}^2U(1)_{\text{conn}}) & \xrightarrow{\text{hol}_{S^1}} & \mathbf{BU}(1)_{\text{conn}} .
\end{array}$$

This is a transgression-compatibility of the form that we have already seen in section 1.2.15.1.2.

In summary, we obtain the transgression of the extended Lagrangian of the open string in the background of B-field and Chan-Paton bundles as the following pasting diagram of moduli stacks in \mathbf{H} (all squares are filled with homotopy 2-cells, which are notationally suppressed for readability)

$$\begin{array}{ccccc}
\mathbf{Fields}_{\text{OpenString}}(\iota_{\partial\Sigma}) & \longrightarrow & \mathbf{Maps}(\Sigma, G) & \xrightarrow{\exp(2\pi i \int_{\Sigma} [\Sigma, \mathbf{wz w}])} & \underline{\mathbb{C}}//\underline{U}(1)_{\text{conn}} \\
\downarrow & & \downarrow \mathbf{Maps}(\iota_{\partial\Sigma}, G) & & \downarrow \\
\mathbf{Maps}(S^1, Q) & \xrightarrow{\mathbf{Maps}(S^1, \iota_Q)} & \mathbf{Maps}(S^1, G) & & \\
\downarrow \mathbf{Maps}(S^1, \widehat{\Psi}) & & \downarrow \mathbf{Maps}(S^1, \mathbf{wz w}) & & \\
\mathbf{Maps}(S^1, (\mathbf{BU}(n)//\mathbf{BU}(1))_{\text{conn}}) & \xrightarrow{\mathbf{Maps}(S^1, (\mathbf{dd}_n)_{\text{conn}})} & \mathbf{Maps}(S^1, \mathbf{B}^2U(1)_{\text{conn}}) & \xrightarrow{\text{hol}_{S^1}} & \mathbf{BU}(1)_{\text{conn}} \\
\downarrow \text{tr hol}_{S^1} & & & & \downarrow \\
\underline{\mathbb{C}}//\underline{U}(1)_{\text{conn}} & \longrightarrow & & & \mathbf{BU}(1)_{\text{conn}}
\end{array}$$

Here

- the top left square is the homotopy pullback square that computes the mapping stack $\mathbf{Maps}(\iota_{\partial\Sigma}, \iota_Q)$ in $\mathbf{H}^{(\Delta^1)}$, which here is simply the smooth space of string configurations $\Sigma \rightarrow G$ which are such that the string boundary lands on the D-brane Q ;
- the top right square is the twisted fiber integration of the $\mathbf{wz w}$ background 2-bundle with connection: this exhibits the parallel transport of the 2-form connection over the worldvolume Σ with boundary S^1 as a section of the pullback of the transgression line bundle on loop space to the space of maps out of Σ ;
- the bottom square is the above compatibility between the twisted traced holonomy of twisted unitary bundles and the transgression of their twisting 2-bundles.

The total diagram obtained this way exhibits a difference between two section of a single complex line bundle on $\mathbf{Fields}_{\text{OpenString}}(\iota_{\partial\Sigma})$ (at least one of them non-vanishing), hence a map

$$\exp\left(2\pi i \int_{\Sigma} [\Sigma, \mathbf{wz w}]\right) \cdot \text{tr hol}_{S^1}([S^1, \widehat{\Psi}]) : \mathbf{Fields}_{\text{OpenString}}(\iota_{\partial\Sigma}) \longrightarrow \underline{\mathbb{C}} .$$

This is the well-defined action functional of the open string with endpoints on the D-brane $Q \hookrightarrow G$, charged under the background $\mathbf{wz w}$ B-field and under the twisted Chan-Paton gauge bundle $\widehat{\Psi}$.

Unwinding the definitions, one finds that this phenomenon is precisely the twisted-bundle-part, due to Kapustin [Ka99], of the Freed-Witten anomaly cancellation for open strings on D-branes, hence is the Freed-Witten-Kapustin anomaly cancellation mechanism either for the open bosonic string or else for the open type II superstring on Spin^c -branes. Notice how in the traditional discussion the existence of twisted bundles on the D-brane is identified just as *some* construction that happens to cancel the B-field anomaly. Here, in the perspective of extended quantization, we see that this choice follows uniquely from the general theory of extended prequantization, once we recognize that $\mathbf{d}\mathbf{d}_n$ above is (the universal associated 2-bundle induced by) the canonical representation of the circle 2-group $\mathbf{B}U(1)$, just as in one codimension up \mathbb{C} is the canonical representation of the circle 1-group $U(1)$.

2 Homotopy type theory

We discuss here aspects of *homotopy type theory*, the theory of locally cartesian closed ∞ -categories and of ∞ -toposes, that we need in the following. Much of this is a review of material available in the literature, we just add some facts that we will need and for which we did not find a citation. The reader at least roughly familiar with this theory can skip ahead to our main contribution, the discussion of *cohesive ∞ -toposes* in 3. We will refer back to these sections here as needed.

2.1 ∞ -Categories

The natural joint generalization of the notion of *category* and of *homotopy type* is that of ∞ -category: a collection of objects, such that between any ordered pair of them there is a homotopy type of morphisms. We briefly survey key definitions and properties in the theory of ∞ -categories.

- 2.1.1 – Dependent homotopy types and Locally cartesian closed ∞ -categories;
- 2.1.2 – Presentation by simplicial sets;
- 2.1.3 – Presentation by simplicially enriched categories.

2.1.1 Dependent homotopy types and Locally cartesian closed ∞ -categories

For the most basic notions of category theory see the first pages of [MacMoe92] or A.1 in [L-Topos].

Definition 2.1.1. A category \mathcal{C} is called *cartesian closed* if it has Cartesian products $X \times Y$ of all objects $X, Y \in \mathcal{C}$ and if there is for each $X \in \mathcal{C}$ a mapping space functor $[X, -] : \mathcal{C} \rightarrow \mathcal{C}$, characterized by the fact that there is a bijection of hom-sets

$$\mathcal{C}(X \times A, Y) \simeq \mathcal{C}(A, [X, Z])$$

natural in the objects $A, X, Y \in \mathcal{C}$. A category \mathcal{C} is called *locally cartesian closed* if for each object $X \in \mathcal{C}$ the slice category $\mathcal{C}_{/X}$ is a cartesian closed category.

The main example of locally cartesian closed categories of interest here are toposes, to which we come below in def. 2.2.3. It is useful to equivalently re-express local cartesian closure in terms of *base change*:

Proposition 2.1.2. *If \mathcal{C} is a locally cartesian closed category, def. 2.1.1, then for $f : X \rightarrow Y$ any morphism in \mathcal{C} there exists an adjoint triple of functors between the slice categories over X and Y (called base change functors)*

$$\mathcal{C}_{/\Gamma_1} \begin{array}{c} \xrightarrow{f_!} \\ \xleftarrow{f^*} \\ \xrightarrow{f_*} \end{array} \mathcal{C}_{/\Gamma_2} ,$$

where f^* is given by pullback along f , $f_!$ is its left adjoint and f_* its right adjoint. Conversely, if a category \mathcal{C} has pullbacks and has for every morphism f a left and right adjoint $f_!$ and f_* to the pullback functor f^* , then it is locally cartesian closed.

It turns out that base change may usefully be captured syntactically such as to constitute a flavor of formal logic called *constructive set theory* or *type theory* [ML74]:

Definition 2.1.3. Given a locally cartesian closed category \mathcal{C} , one says equivalently that

- its internal logic is a *dependent type theory*;
- it provides *categorical semantics* for dependent type theory

as follows:

- the objects of \mathcal{C} are called the *types*;
- the objects in a slice \mathcal{C}/Γ are called the types *in context* Γ or *dependent on* Γ , denoted

$$\Gamma \vdash X : \text{Type}$$

- a morphism $* \rightarrow X$ (from the terminal object into any object X) in a slice \mathcal{C}/Γ is called a *term of type* X in context Γ , and denoted

$$\Gamma \vdash x : X$$

or more explicitly

$$a : \Gamma \vdash x(a) : X(a);$$

- given a morphism $f : \Gamma_1 \rightarrow \Gamma_2$ in \mathcal{C} with its induced base change adjoint triple of functors between slice categories from prop. 2.1.2

$$\begin{array}{ccc} & \xrightarrow{f_!} & \\ \mathcal{C}/\Gamma_1 & \xleftarrow{f^*} & \mathcal{C}/\Gamma_2 \\ & \xrightarrow{f_*} & \end{array}$$

then

- given a morphism $(* \rightarrow X)$ in \mathcal{C}/Γ_2 , hence a term $\Gamma_2 \vdash x : X$, then its pullback by f^* is denoted by *substitution* of variables

$$a : \Gamma_1 \vdash x(f(a)) : X(f(a)),$$

- given an object $X \in \mathcal{C}/\Gamma_1$ its image $f_!(X) \in \mathcal{C}/\Gamma_2$ is called the *dependent sum* of X along f and is denoted as

$$\Gamma_2 \vdash \sum_f X : \text{Type},$$

- given an object $X \in \mathcal{C}/\Gamma_1$ its image $f_*(X) \in \mathcal{C}/\Gamma_2$ is called the *dependent product* of X along f and is denoted as

$$\Gamma_2 \vdash \prod_f X : \text{Type},$$

- the universal property of the adjoints $(f_! \dashv f^* \dashv f_*)$ translates to evident rules for introducing and for transforming terms of these dependent sum/product types, called *term introduction* and *term elimination* rules.

We consider bundles and base change in more detail below in 3.6.1.

When this syntactic translation is properly formalized, it yields an equivalent description of locally cartesian closed categories:

Proposition 2.1.4 ([Se84, ClDy11]). *There is an equivalence of 2-categories between locally cartesian closed categories and dependent type theories.*

Remark 2.1.5. Given any object $X \in \mathcal{C}/\Gamma$, its diagonal $X \rightarrow X \times X$ regarded as an object of $\mathcal{C}/(\Gamma \times X \times X)$ serves as the *identity type* of X , denoted

$$\Gamma, (x_1, x_2) : X \times X \vdash (x_1 = x_2) : \text{Type}.$$

Namely given two terms $x_1, x_2 : X$, then a term $\Gamma \vdash p : (x_1 = x_2)$ is as a morphism in \mathcal{C} an element on the diagonal of $X \times X$ and in the type theory is a *proof of equality* of x_1 and x_2 . If there is such a proof of equality then it is unique, since the diagonal is always a monomorphism.

But consider now the case that \mathcal{C} in addition carries the structure of a *model category* (see A.2 in [L-Topos] for a review). Then there is for each X a path space object $X^I \rightarrow X \times X$. Using this as the categorical semantics of identity types, instead of the plain diagonal $X \rightarrow X \times X$, means to make identity behave

instead like *higher gauge equivalence* in physics: there are then possibly many equivalences between two terms of a given type, and many equivalences between equivalences, and so on. If \mathcal{C} is moreover right proper as a model category and such that its cofibrations are precisely its monomorphisms, then there exists a variant of the dependent type theory of remark 2.1.3 reflecting these homotopy-theoretic identity types. This is called dependent type theory *with intensional identity types* or, more recently, *homotopy type theory* [UFP13]. At the same time, such a model category is a presentation for the homotopy-theoretic analogy of a locally cartesian closed category: a *locally cartesian closed* $(\infty, 1)$ -category (see A.3 of [L-Topos]).

The following was maybe first explicitly suggested by [Jo08a]. A proof of the technical details involved appeared in [CiSh13].

Proposition 2.1.6. *Up to equivalence, the internal type theory of a locally Cartesian closed $(\infty, 1)$ -category is homotopy type theory (without necessarily univalence) and conversely homotopy type theory (without necessarily univalence) has categorical semantics in locally cartesian closed $(\infty, 1)$ -categories.*

We now turn to description such ∞ -categories “externally” in terms of simplicial sets and categories enriched over simplicial sets. We briefly come back to the “internal” perspective of homotopy type theory below in 3.4.1.2.

2.1.2 Presentation by simplicial sets

Definition 2.1.7. An ∞ -category is a simplicial set C such that all horns $\Lambda^i[n] \rightarrow C$ that are *inner*, in that $0 < i < n$, have an extension to a simplex $\Delta[n] \rightarrow C$.

A vertex $c \in C_0$ is an *object*, an edge $f \in C_1$ is a *morphism* in C .

An ∞ -functor $f : C \rightarrow D$ between ∞ -categories C and D is a morphism of the underlying simplicial sets.

This definition is due [Jo08a].

Remark 2.1.8. For C an ∞ -category, we think of C_0 as its collection of *objects*, and of C_1 as its collection of *morphisms* and generally of C_k as the collection of *k-morphisms*. The inner horn filling property can be seen to encode the existence of composites of *k-morphisms*, well defined up to coherent $(k + 1)$ -morphisms. It also implies that for $k > 1$ these *k-morphisms* are invertible, up to higher morphisms. To emphasize this fact one also says that C is an $(\infty, 1)$ -category. (More generally an (∞, n) -category would have *k* morphisms for all *k* such that for $k > n$ these are equivalences.)

The power of the notion of ∞ -categories is that it supports the higher analogs of all the crucial facts of ordinary category theory. This is a useful meta-theorem to keep in mind, originally emphasized by André Joyal and Charles Rezk.

Fact 2.1.9. *In general*

- ∞ -Category theory parallels category theory;
- ∞ -Topos theory parallels topos theory.

More precisely, essentially all the standard constructions and theorems have their ∞ -analogs if only we replace *isomorphism* between objects and equalities between morphisms consistently by *equivalences* and coherent higher equivalences in an ∞ -category.

Proposition 2.1.10. *For C and D two ∞ -categories, the internal hom of simplicial sets $\text{sSet}(C, D) \in \text{sSet}$ is an ∞ -category.*

Definition 2.1.11. We write $\text{Func}(C, D)$ for this ∞ -category and speak of the ∞ -category of ∞ -functors between C and D .

Remark 2.1.12. The objects of $\text{Func}(C, D)$ are indeed the ∞ -functors from def. 2.1.7. The morphisms may be called *∞ -natural transformations*.

Definition 2.1.13. The *opposite* C^{op} of an ∞ -category C is the ∞ -category corresponding to the opposite of the corresponding sSet -category.

Definition 2.1.14. Let $\text{KanCplx} \subset \text{sSet}$ be the full subcategory of sSet on the Kan complexes, regarded naturally as an sSet -enriched category, in fact a Kan-complex enriched category. Below in 2.1.3 we recall the *homotopy coherent nerve* construction N_h that sends a Kan-complex enriched category to an ∞ -category.

We say that

$$\infty\text{Grpd} := N_h\text{KanCplx}$$

is the *∞ -category of ∞ -groupoids*.

Definition 2.1.15. For C an ∞ -category, we write

$$\text{PSh}_{\infty}(C) := \text{Func}(C^{\text{op}}, \infty\text{Grpd})$$

and speak of the *∞ -category of ∞ -presheaves* on C .

The following is the ∞ -category theory analog of the Yoneda lemma.

Proposition 2.1.16. For C an ∞ -category, $U \in C$ any object, $j(U) \simeq C(-, U) : C^{\text{op}} \rightarrow \infty\text{Grpd}$ an ∞ -presheaf represented by U we have for every ∞ -presheaf $F \in \text{PSh}_{\infty}(C)$ a natural equivalence of ∞ -groupoids

$$\text{PSh}_{\infty}(C)(j(U), F) \simeq F(U).$$

From this derives a notion of ∞ -limits and of adjoint ∞ -functors and they satisfy the expected properties. This we discuss below in 2.3.

2.1.3 Presentation by simplicially enriched categories

A convenient way of handling ∞ -categories is via sSet -enriched categories: categories which for each ordered pair of objects has not just a set of morphisms, but a simplicial set of morphisms (see [Ke82] for enriched category theory in general and section A of [L-Topos] for sSet -enriched category theory in the context of ∞ -category theory in particular):

Proposition 2.1.17. *There exists an adjunction between simplicially enriched categories and simplicial sets*

$$(|-| \dashv N_h) : \text{sSetCat} \begin{array}{c} \xleftarrow{|-|} \\ \xrightarrow{N_h} \end{array} \text{sSet}$$

such that

- if $S \in \text{sSetCat}$ is such that for all objects $X, Y \in S$ the simplicial set $S(X, Y)$ is a Kan complex, then $N_h(S)$ is an ∞ -category;
- the unit of the adjunction is an equivalence of ∞ -categories (see def. 2.1.19 below).

This is for instance prop. 1.1.5.10 in [L-Topos].

Remark 2.1.18. In particular, for C an ordinary category, regarded as an sSet -category with simplicially constant hom-objects, $N_h C$ is an ∞ -category. A functor $C \rightarrow D$ is precisely an ∞ -functor $N_h C \rightarrow N_h D$. In this and similar cases we shall often notationally suppress the N_h -operation. This is justified by the following statements.

Definition 2.1.19. For C an ∞ -category, its *homotopy category* $\mathrm{Ho}(C)$ (or Ho_C) is the ordinary category obtained from $|C|$ by taking connected components of all simplicial hom-sets:

$$\mathrm{Ho}_C(X, Y) = \pi_0(|C|(X, Y)).$$

A morphism $f \in C_1$ is called an *equivalence* if its image in $\mathrm{Ho}(C)$ is an isomorphism. Two objects in C connected by an equivalence are called *equivalent objects*.

Definition 2.1.20. An ∞ -functor $F : C \rightarrow D$ is called an *equivalence of ∞ -categories* if

1. It is *essentially surjective* in that the induced functor $\mathrm{Ho}(f) : \mathrm{Ho}(C) \rightarrow \mathrm{Ho}(D)$ is essentially surjective;
2. and it is *full and faithful* in that for all objects X, Y the induced morphism $f_{X,Y} : |C|(X, Y) \rightarrow |D|(X, Y)$ is a weak homotopy equivalence of simplicial sets.

For C an ∞ -category and X, Y two of its objects, we write

$$C(X, Y) := |C|(X, Y)$$

and call this Kan complex the *hom- ∞ -groupoid* of C from X to Y .

The following assertion guarantees that sSet-categories are indeed a faithful presentation of ∞ -categories.

Proposition 2.1.21. *For every ∞ -category C the unit of the $(| - | \dashv N_h)$ -adjunction from prop. 2.1.17 is an equivalence of ∞ -categories*

$$C \xrightarrow{\cong} N_h|C|.$$

This is for instance theorem 1.1.5.13 together with remark 1.1.5.17 in [L-Topos].

Definition 2.1.22. An ∞ -groupoid is an ∞ -category in which all morphisms are equivalences.

Proposition 2.1.23. *∞ -groupoids in this sense are precisely Kan complexes.*

This is due to [Jo02]. See also prop. 1.2.5.1 in [L-Topos].

A convenient way of constructing ∞ -categories in terms of sSet-categories is via categories with weak equivalences.

Definition 2.1.24. A *category with weak equivalences* (C, W) is a category C equipped with a subcategory $W \subset C$ which contains all objects of C and such that W satisfies the *2-out-of-3 property*: for every commuting triangle

$$\begin{array}{ccc} & y & \\ x \swarrow & & \searrow z \\ & x \xrightarrow{\quad} & z \end{array}$$

in C with two of the three morphisms in W , also the third one is in W .

Definition 2.1.25. The *simplicial localization* of a category with weak equivalences (C, W) is the sSet-category

$$L_W C \in \mathrm{sSetCat}$$

(or LC for short, when W is understood) given as follows: the objects are those of C ; and for $X, Y \in C$ two objects, the simplicial hom-set $LC(X, Y)$ is the inductive limit over $n \in \mathbb{N}$ of the nerves of the following categories:

- objects are equivalence classes of zig-zags of length n of morphisms

$$X \xleftarrow{\simeq} K_1 \xrightarrow{\quad} K_2 \xleftarrow{\simeq} \dots \xrightarrow{\quad} Y$$

in C , such that the left-pointing morphisms are in W ;

- morphisms are equivalence classes of transformations of such zig-zags

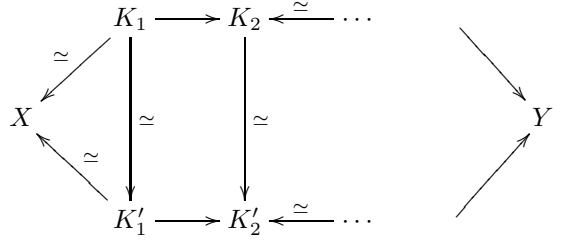

such that the vertical morphisms are in W ;

- subject to the equivalence relation that identifies two such (transformations of) zig-zags if one is obtained from the other by discarding identity morphisms and then composing consecutive morphisms.

This simplicial “hammock localization” is due to [DwKa80a].

Proposition 2.1.26. *Let (C, W) be a category with weak equivalences and LC be its simplicial localization. Then its homotopy category in the sense of def. 2.1.19 is equivalent to the ordinary homotopy category $\text{Ho}(C, W)$ (the category obtained from C by universally inverting the morphisms in W):*

$$\text{Ho}L_W C \simeq \text{Ho}(C, W).$$

A convenient way of controlling simplicial localizations is via $\text{sSet}_{\text{Quillen}}$ -enriched model category structures (see section A.2 of [L-Topos] for a good discussion of all related issues).

Definition 2.1.27. A *model category* is a category with weak equivalences (C, W) that has all limits and colimits and is equipped with two further classes of morphisms, $\text{Fib}, \text{Cof} \subset \text{Mor}(C)$ – the *fibrations* and *cofibrations* – such that $(\text{Cof}, \text{Fib} \cap W)$ and $(\text{Cof} \cap W, \text{Fib})$ are two weak factorization systems on C . Here the elements in $\text{Fib} \cap W$ are called *acyclic fibrations* and those in $\text{Cof} \cap W$ are called *acyclic cofibrations*. An object $X \in C$ is called *cofibrant* if the canonical morphism $\emptyset \rightarrow X$ is a cofibration. It is called *fibrant* if the canonical morphism $X \rightarrow *$ is a fibration.

A *Quillen adjunction* between two model categories is a pair of adjoint functors between the underlying categories, such that the right adjoint preserves cofibrations and acyclic cofibrations, which equivalently means that the left adjoint preserves cofibrations and acyclic cofibrations.

Remark 2.1.28. The axioms on model categories directly imply that every object is weakly equivalent to a fibrant object, and to a cofibrant objects and in fact to a fibrant and cofibrant objects.

Example 2.1.29. The category of simplicial sets carries a model category structure, here denoted $\text{sSet}_{\text{Quillen}}$, whose weak equivalences are the weak homotopy equivalences, cofibrations are the monomorphisms, and fibrations and the Kan fibrations.

Definition 2.1.30. Let A, B, C be model categories. Then a functor

$$F : A \times B \rightarrow C$$

is a *left Quillen bifunctor* if

1. it preserves colimits separately in each argument;
2. for $i : a \rightarrow a'$ and $j : b \rightarrow b'$ two cofibrations in A and in B , respectively, the canonical induced morphism

$$F(a', b) \coprod_{F(a, b)} F(a, b') \rightarrow F(a', b')$$

is a cofibration in C and is in addition a weak equivalence if i or j is.

Remark 2.1.31. In particular, for $F : A \times B \rightarrow C$ a left Quillen bifunctor, if $a \in A$ is cofibrant then

$$F(a, -) : B \rightarrow C$$

is an ordinary left Quillen functor if F is a left Quillen bifunctor, as is

$$F(-, b) : A \rightarrow C$$

for b cofibrant.

Definition 2.1.32. A *monoidal model category* is a category equipped both with the structure of a model category and with the structure of a monoidal category, such that the tensor product functor of the monoidal structure is a left Quillen bifunctor, def. 2.1.30, with respect to the model category structure.

Example 2.1.33. The model category $\text{sSet}_{\text{Quillen}}$ is a monoidal model category with respect to its Cartesian monoidal structure.

Definition 2.1.34. For \mathcal{V} a monoidal model category, an \mathcal{V} -*enriched model category* is a model category equipped with the structure of an \mathcal{V} -enriched category which is also \mathcal{V} -tensored and -cotensored, such that the \mathcal{V} -tensoring functor is a left Quillen bifunctor, def. 2.1.30.

Remark 2.1.35. An $\text{sSet}_{\text{Quillen}}$ -enriched model category is often called a *simplicial model category*. Notice that, while entirely standard, this use of terminology is imprecise: first, not every simplicial object in categories is a sSet -enriched category, and second, there are other and inequivalent model category structure on sSet that make it a monoidal model category with respect to its Cartesian monoidal structure.

Definition 2.1.36. For C an ($\text{sSet}_{\text{Quillen}}$ -enriched) model category write

$$C^\circ \in \text{sSetCat}$$

for the full sSet -subcategory on the fibrant and cofibrant objects.

Proposition 2.1.37. *Let C be an $\text{sSet}_{\text{Quillen}}$ -enriched model category. Then there is an equivalence of ∞ -categories*

$$C^\circ \simeq LC.$$

This is corollary 4.7 with prop. 4.8 in [DwKa80b].

Proposition 2.1.38. *The hom- ∞ -groupoids $(N_h C^\circ)(X, Y)$ are already correctly given by the hom-objects in C from a cofibrant to a fibrant representative of the weak equivalence class of X and Y , respectively.*

In this way $\text{sSet}_{\text{Quillen}}$ -enriched model category structures constitute particularly convenient extra structure on a category with weak equivalences for constructing the corresponding ∞ -category.

In terms of the presentation of ∞ -categories by simplicial categories, 2.1.3, adjoint ∞ -functors are presented by *simplicial Quillen adjunctions*, def. 2.1.27, between simplicial model categories: the restriction of a simplicial Quillen adjunction to fibrant-cofibrant objects is the sSet -enriched functor that presents the ∞ -derived functor under the model of ∞ -categories by simplicially enriched categories.

Proposition 2.1.39. *Let C and D be simplicial model categories and let*

$$(L \dashv R) : C \begin{array}{c} \xleftarrow{L} \\ \xrightarrow{R} \end{array} D$$

be an sSet -enriched adjunction whose underlying ordinary adjunction is a Quillen adjunction. Let C° and D° be the ∞ -categories presented by C and D (the Kan complex-enriched full sSet -subcategories on fibrant-cofibrant objects). Then the Quillen adjunction lifts to a pair of adjoint ∞ -functors

$$(\mathbb{L}L \dashv \mathbb{R}R) : C^\circ \begin{array}{c} \xleftarrow{\quad} \\ \xrightarrow{\quad} \end{array} D^\circ$$

On the decategorified level of the homotopy categories these are the total left and right derived functors, respectively, of L and R .

This is [L-Topos], prop 5.2.4.6.

The following proposition states conditions under which a simplicial Quillen adjunction may be detected already from knowing of the right adjoint only that it preserves fibrant objects (instead of all fibrations).

Proposition 2.1.40. *If C and D are simplicial model categories and D is a left proper model category, then for an sSet-enriched adjunction*

$$(L \dashv R) : C \rightleftarrows D$$

to be a Quillen adjunction it is already sufficient that L preserves cofibrations and R preserves fibrant objects.

This appears as [L-Topos], cor. A.3.7.2.

We will use this for finding simplicial Quillen adjunctions into left Bousfield localizations of left proper model categories: the left Bousfield localization preserves the left properness, and the fibrant objects in the Bousfield localized structure have a good characterization: they are the fibrant objects in the original model structure that are also local objects with respect to the set of morphisms at which one localizes. Therefore for D the left Bousfield localization of a simplicial left proper model category E at a class S of morphisms, for checking the Quillen adjunction property of $(L \dashv R)$ it is sufficient to check that L preserves cofibrations, and that R takes fibrant objects c of C to such fibrant objects of E that have the property that for all $f \in S$ the derived hom-space map $\mathbb{R}\mathrm{Hom}(f, R(c))$ is a weak equivalence.

2.2 ∞ -Toposes

The natural context for discussing the geometry of spaces that are locally modeled on test spaces in some category C (and equipped with a notion of coverings) is the category called the *sheaf topos* $\mathrm{Sh}(C)$ over C [Joh02]. Analogously, the natural context for discussing the *higher* geometry of such spaces is the ∞ -category called the ∞ -*sheaf topos* $\mathbf{H} = \mathrm{Sh}_\infty(C)$.

The theory of ∞ -toposes has been given a general abstract formulation in [L-Topos], using the ∞ -category theory introduced by [Jo08a] and building on [Re05] and [ToVe02]. One of the central results proven there is that the old homotopy theory of simplicial presheaves, originating around [Br73] and developed notably in [Jard87] and [Dug01], is indeed a *presentation* of ∞ -topos theory.

- 2.2.1 – Abstract ∞ -category theoretic characterization
- 2.2.2 – Homotopy type theory with type universes
- 2.2.3 – Presentation by simplicial (pre-)sheaves
- 2.2.4 – Presentation by simplicial objects in the site
- 2.2.5 – ∞ -Sheaves and descent
- 2.2.6 – ∞ -Sheaves with values in chain complexes

2.2.1 Abstract ∞ -category theoretic characterization

Following [L-Topos], for us “ ∞ -topos” means this:

Definition 2.2.1. An ∞ -topos is an accessible ∞ -geometric embedding

$$\mathbf{H} \xleftarrow{L} \mathrm{Func}(C^{\mathrm{op}}, \infty\mathrm{Grpd})$$

into an ∞ -category of ∞ -presheaves, def. 2.1.15 over some small ∞ -category C , hence a full and faithful embedding functor which preserves filtered ∞ -colimits, and has a left adjoint ∞ -functor which preserves finite ∞ -limits.

We say this is an ∞ -category of ∞ -sheaves (as opposed to a hypercompletion of such) if \mathbf{H} is the reflective localization at the covering sieves of a Grothendieck topology on the homotopy category of C (a *topological localization*), and then write $\mathbf{H} = \mathrm{Sh}_\infty(C)$ with the site structure on C understood.

More intrinsically, ∞ -toposes are characterized as follows (we review the ingredients of the following statement in 2.3 and 3.6.7 below).

Definition 2.2.2 (Giraud-Rezk-Lurie axioms). An ∞ -topos is a presentable ∞ -category \mathbf{H} that satisfies the following properties.

1. **Coproducts are disjoint.** For every two objects $A, B \in \mathbf{H}$, the intersection of A and B in their coproduct is the initial object: in other words the diagram

$$\begin{array}{ccc} \emptyset & \longrightarrow & B \\ \downarrow & & \downarrow \\ A & \longrightarrow & A \coprod B \end{array}$$

is a pullback.

2. **Colimits are preserved by pullback.** For all morphisms $f: X \rightarrow B$ in \mathbf{H} and all small diagrams $A: I \rightarrow \mathbf{H}/_B$, there is an equivalence

$$\varinjlim_i f^* A_i \simeq f^* (\varinjlim_i A_i)$$

between the pullback of the colimit and the colimit over the pullbacks of its components.

3. **Quotient maps are effective epimorphisms.** Every simplicial object $A_\bullet: \Delta^{\mathrm{op}} \rightarrow \mathbf{H}$ that satisfies the groupoidal Segal property (Definition 3.6.88) is the Čech nerve of its quotient projection:

$$A_n \simeq A_0 \times_{\varinjlim_n A_n} A_0 \times_{\varinjlim_n A_n} \cdots \times_{\varinjlim_n A_n} A_0 \quad (n \text{ factors}).$$

The equivalence of these two definitions is theorem 6.1.0.6 in [L-Topos].

An ordinary topos is famously characterized by the existence of a classifier object for monomorphisms, the *subobject classifier*. With hindsight, this statement already carries in it the seed of the close relation between topos theory and bundle theory, for we may think of a monomorphism $E \hookrightarrow X$ as being a *bundle of (-1) -truncated fibers* over X . The following axiomatizes the existence of arbitrary universal bundles

Definition 2.2.3. An ∞ -topos \mathbf{H} is a presentable ∞ -category with the following properties.

1. **Colimits are preserved by pullback.**
2. **There are universal κ -small bundles.** For every sufficiently large regular cardinal κ , there exists a morphism $\widehat{\mathrm{Obj}}_\kappa \rightarrow \mathrm{Obj}_\kappa$ in \mathbf{H} which *represents the core of the κ -small codomain fibration* in that for every object X , there is an equivalence

$$\mathrm{name}: \mathrm{Core}(\mathbf{H}/_{\kappa X}) \xrightarrow{\simeq} \mathbf{H}(X, \widehat{\mathrm{Obj}}_\kappa)$$

between the ∞ -groupoid of bundles (morphisms) $E \rightarrow X$ which are relatively κ -small over X and the ∞ -groupoid of morphisms from X into Obj_κ , such that there are ∞ -pullback squares

$$\begin{array}{ccc} E & \longrightarrow & \widehat{\mathrm{Obj}}_\kappa \\ \downarrow & & \downarrow \\ X & \xrightarrow{\mathrm{name}(E)} & \mathrm{Obj}_\kappa \end{array} .$$

These two characterizations of ∞ -toposes, Definition 2.2.2 and Definition 2.2.3 are equivalent; this is due to Rezk and Lurie, appearing as Theorem 6.1.6.8 in [L-Topos]. We find that the second of these axioms gives the equivalence between V -fiber bundles and $\mathbf{Aut}(V)$ -principal ∞ -bundles in Proposition 3.6.210.

For \mathbf{H} an ∞ -topos we write $\mathbf{H}(X, Y)$ for its hom- ∞ -groupoid between objects X and Y and write $H(X, Y) = \pi_0 \mathbf{H}(X, Y)$ for the hom-set in the homotopy category.

The theory of cohesive ∞ -toposes revolves around situations where the following fact has a refinement:

Proposition 2.2.4. *For every ∞ -topos \mathbf{H} there is an essentially unique geometric morphism to the ∞ -topos ∞Grpd .*

$$(\Delta \dashv \Gamma) : \mathbf{H} \begin{array}{c} \xleftarrow{\Delta} \\ \xrightarrow{\Gamma} \end{array} \infty\text{Grpd}$$

This is prop 6.3.41 in [L-Topos].

Proposition 2.2.5. *Here Γ forms global sections, in that $\Gamma(-) \simeq \mathbf{H}(*, -)$, and Δ forms constant ∞ -sheaves $-\Delta(-) \simeq L\text{Const}(-)$.*

Proof. By prop. 2.2.4 it is sufficient to exhibit an ∞ -adjunction $(L\text{Const}(-) \dashv \mathbf{H}(*, -))$ such that the left adjoint preserves finite ∞ -limits. The latter follows since $\text{Const} : \infty\text{Grpd} \rightarrow \text{PSh}_\infty(C)$ preserves all limits (for C some ∞ -site of definition for \mathbf{H}) and $L : \text{PSh}(C) \rightarrow \mathbf{H}$ by definition preserves finite ∞ -limits. To show the ∞ -adjunction we use prop. 2.3.1, which says that every ∞ -groupoid is the ∞ -colimit over itself of the ∞ -functor constant on the point: $S \simeq \lim_{\rightarrow S} *$. From this we obtain the natural hom-equivalence

$$\begin{aligned} \mathbf{H}(L\text{Const}S, X) &\simeq \text{PSh}_C(\text{Const}S, X) \\ &\simeq \text{PSh}(\text{Const} \lim_{\rightarrow S} *, X) \\ &\simeq \lim_{\leftarrow S} \text{Psh}(\text{Const}*, X) \\ &\simeq \lim_{\leftarrow S} \mathbf{H}(L\text{Const}*, X) \\ &\simeq \lim_{\leftarrow S} \mathbf{H}(*, X) \\ &\simeq \lim_{\leftarrow S} \infty\text{Grpd}(*, \mathbf{H}(*, X)) \\ &\simeq \infty\text{Grpd}(\lim_{\rightarrow S} *, \mathbf{H}(*, X)) \\ &\simeq \infty\text{Grpd}(S, \mathbf{H}(*, X)). \end{aligned}$$

Here and in the following “ $*$ ” always denotes the terminal object in the corresponding ∞ -category. We used that $L\text{Const}$ preserves the terminal object (the empty ∞ -limit.) \square

2.2.2 Syntax of homotopy type theory with type universes

Above in 2.1.1 we indicated how locally cartesian closed ∞ -categories have an internal homotopy type theory. In locally cartesian closed ∞ -categories which are ∞ -toposes, the “object of small objects” of def. 2.2.2 above is internally the *type of types* denoted Type [UFP13].

In this context the type theoretic judgement “ $x : X \vdash E(x) : \text{Type}$ ” is interpreted in the ∞ -topos as the *name* morphism $X \xrightarrow{\text{name}(E)} \text{Obj}_\kappa$ of a morphism $E \rightarrow X$ in the ∞ -topos, according to def. 2.2.3. If here we declare to abbreviate $(\vdash E) := \text{name}(E)$ then this means we have the following dictionary between the symbols used to talk about objects of slices in ∞ -toposes and equivalently dependent types in homotopy type theory.

morphisms to sequents:

notation in \ for	objects/types	elements/terms
∞ -topos theory	$X \xrightarrow{\vdash E}$	$X \xrightarrow{t} X \quad E$
homotopy type theory	$x : X \vdash E(x) \quad :$ Type	$x : X \vdash t(x) \quad :$ $E(x)$

2.2.3 Presentation by simplicial (pre-)sheaves

For computations it is useful to employ a generators-and-relations presentation of presentable ∞ -categories in general and of ∞ -toposes in particular, given by ordinary \mathbf{sSet} -enriched categories equipped with the structure of combinatorial simplicial model categories. These may be obtained by left Bousfield localization of a model structure on simplicial presheaves (as reviewed in appendix 2 and 3 of [L-Topos]).

We discuss these presentations and then discuss various constructions in terms of these presentations that will be useful over and over again in the following. Much of this material is standard and our discussion serves to briefly collect the relevant pieces. But we also highlight a few points that are not usually discussed explicitly in the literature, but which we will need later on.

Definition 2.2.6. Let C be a small category.

- Write $[C^{\text{op}}, \mathbf{sSet}]$ for the category of functors $C^{\text{op}} \rightarrow \mathbf{sSet}$ to the category of simplicial sets. This is naturally equivalent to the category $[\Delta^{\text{op}}, [C^{\text{op}}, \mathbf{Set}]$ of simplicial objects in the category of presheaves on C . Therefore one speaks of the *category of simplicial presheaves over C* .
- For $\{U_i \rightarrow U\}$ a covering family in the site C , write

$$C(\{U_i\}) \in [C^{\text{op}}, \mathbf{sSet}] := \int^{[k] \in \Delta} \Delta[k] \cdot \prod_{i_0, \dots, i_k} j(U_{i_0}) \times_{j(U)} \cdots \times_{j(U)} j(U_{i_k})$$

for the corresponding *Čech nerve* simplicial presheaf. This is in degree k the disjoint union of the $(k+1)$ -fold intersections of patches of the cover. It is canonically equipped with a morphism $C(\{U_i\}) \rightarrow j(U)$. (Here $j : C \rightarrow [C^{\text{op}}, \mathbf{Set}]$ is the Yoneda embedding.)

- The category $[C^{\text{op}}, \mathbf{sSet}]$ is naturally an \mathbf{sSet} -enriched category. For any two objects $X, A \in [C^{\text{op}}, \mathbf{sSet}]$ write $\text{Maps}(X, A) \in \mathbf{sSet}$ for the simplicial hom-set.
- Write $[C^{\text{op}}, \mathbf{sSet}]_{\text{proj}}$ for the category of simplicial presheaves equipped with the following choices of classes of morphisms (which are natural transformations between \mathbf{sSet} -valued functors):
 - the *fibrations* are those morphisms whose component over each object $U \in C$ is a Kan fibration of simplicial sets;
 - the *weak equivalences* are those morphisms whose component over each object is a weak equivalence in the Quillen model structure on simplicial sets;
 - the *cofibrations* are the morphisms having the right lifting property against the morphisms that are both fibrations as well as weak equivalences.

This makes $[C^{\text{op}}, \mathbf{sSet}]_{\text{proj}}$ into a combinatorial simplicial model category.

- Write $[C^{\text{op}}, \mathbf{sSet}]_{\text{proj,loc}}$ for model category structure on simplicial presheaves which is the left Bousfield localization of $[C^{\text{op}}, \mathbf{sSet}]_{\text{proj}}$ at the set of morphisms of the form $C(\{U_i\}) \rightarrow U$ for all covering families $\{U_i \rightarrow U\}$ of C .

This is called the *projective local model structure* on simplicial presheaves [Dug01].

Definition 2.2.7. The operation of forming objectwise simplicial homotopy groups extends to functors

$$\pi_0^{\text{PSh}} : [C^{\text{op}}, \mathbf{sSet}] \rightarrow [C^{\text{op}}, \mathbf{Set}]$$

and for $n > 1$

$$\pi_n^{\text{PSh}} : [C^{\text{op}}, \text{sSet}]_* \rightarrow [C^{\text{op}}, \text{Set}].$$

These presheaves of homotopy groups may be sheafified. We write

$$\pi_0 : [C^{\text{op}}, \text{sSet}] \xrightarrow{\pi_0^{\text{PSh}}} [C^{\text{op}}, \text{Set}] \rightarrow \text{Sh}(C)$$

and for $n > 1$

$$\pi_n : [C^{\text{op}}, \text{sSet}]_* \xrightarrow{\pi_n^{\text{PSh}}} [C^{\text{op}}, \text{Set}] \rightarrow \text{Sh}(C).$$

Proposition 2.2.8. *For $X \in [C^{\text{op}}, \text{sSet}]_{\text{proj,loc}}$ fibrant, the homotopy sheaves $\pi_n(X)$ from def. 2.2.7 coincide with the abstractly defined homotopy groups of $X \in \text{Sh}_\infty(C)$ from [L-Topos].*

Proof. One may observe that the $\text{sSet}_{\text{Quillen}}$ -powering of $[C^{\text{op}}, \text{sSet}]_{\text{proj,loc}}$ does model the abstract ∞Grpd -powering of $\text{Sh}_\infty(C)$. \square

Definition 2.2.9. A site C has *enough points* if a morphism $(A \xrightarrow{f} B) \in \text{Sh}(C)$ in its sheaf topos is an isomorphism precisely if for every *topos point*, hence for every geometric morphism

$$(x^* \dashv x_*) : \text{Set} \begin{array}{c} \xleftarrow{x^*} \\ \xrightarrow{x_*} \end{array} \text{Sh}(C)$$

from the topos of sets we have that $x^*(f) : x^*A \rightarrow x^*B$ is an isomorphism.

Notice here that, by definition of geometric morphism, the functor i^* is left adjoint to i_* – hence preserves all colimits – and in addition preserves all *finite* limits.

Example 2.2.10. The following sites have enough points.

- The categories Mfd (SmoothMfd) of (smooth) finite-dimensional, paracompact manifolds and smooth functions between them;
- the category CartSp of Cartesian spaces \mathbb{R}^n for $n \in \mathbb{N}$ and continuous (smooth) functions between them.

This is discussed in detail below in 4.3.1. We restrict from now on attention to this case.

Assumption 2.2.11. The site C has enough points.

Theorem 2.2.12. *For C a site with enough points, the weak equivalences in $[C^{\text{op}}, \text{sSet}]_{\text{proj,loc}}$ are precisely the stalkwise weak equivalences in $\text{sSet}_{\text{Quillen}}$*

Proof. By theorem 17 in [Ja96] and using our assumption 2.2.11 the statement is true for the local injective model structure. The weak equivalences there coincide with those of the local projective model structure. \square

Definition 2.2.13. We say that a morphism $f : A \rightarrow B$ in $[C^{\text{op}}, \text{sSet}]$ is a *local fibration* or a *local weak equivalence* precisely if for all topos points x the morphism $x^*f : x^*A \rightarrow x^*B$ is a fibration of weak equivalence, respectively.

Warning. While by theorem 2.2.12 the local weak equivalences are indeed the weak equivalences in $[C^{\text{op}}, \text{sSet}]_{\text{proj,loc}}$, it is not true that the fibrations in this model structure are the local fibrations of def. 2.2.13.

Proposition 2.2.14. *Pullbacks in $[C^{\text{op}}, \text{sSet}]$ along local fibrations preserve local weak equivalences.*

Proof. Let

$$\begin{array}{ccccc} A & \longrightarrow & C & \longleftarrow & B \\ \downarrow & & \downarrow & & \downarrow \\ A' & \longrightarrow & C' & \longleftarrow & B' \end{array}$$

be a diagram where the vertical morphisms are local weak equivalences. Since the inverse image x^* of a topos point x preserves finite limits and in particular pullbacks, we have

$$x^*(A \times_C B \xrightarrow{f} A' \times_{C'} B') = (x^*A \times_{x^*C} x^*B \xrightarrow{x^*f} x^*A' \times_{x^*C'} x^*B').$$

On the right the pullbacks are now by assumption pullbacks of simplicial sets along Kan fibrations. Since $\text{sSet}_{\text{Quillen}}$ is right proper, these are homotopy pullbacks and therefore preserve weak equivalences. So x^*f is a weak equivalence for all x and thus f is a local weak equivalence. \square

The following characterization of ∞ -toposes is one of the central statements of [L-Topos]. For the purposes of our discussion here the reader can take this to be the *definition* of ∞ -toposes.

Theorem 2.2.15. *For C a site with enough points, the ∞ -topos over C is the simplicial localization, def. 2.1.25,*

$$\text{Sh}_{\infty}(C) \simeq L([C^{\text{op}}, \text{sSet}]_{\text{proj,loc}})$$

of the category of simplicial presheaves on C at the local weak equivalences.

In view of prop. 2.2.17 this is prop. 6.5.2.14 in [L-Topos].

2.2.4 Presentation by simplicial objects in the site

We will have use of the following different presentation of $\text{Sh}_{\infty}(C)$.

Definition 2.2.16. Let C be a small site with enough points. Write $\bar{C} \subset [C^{\text{op}}, \text{sSet}]$ for the free coproduct completion.

Let $(\bar{C}^{\Delta^{\text{op}}}, W)$ be the category of simplicial objects in \bar{C} equipped with the stalkwise weak equivalences inherited from the canonical embedding

$$i : \bar{C}^{\Delta^{\text{op}}} \hookrightarrow [C^{\text{op}}, \text{sSet}].$$

Proposition 2.2.17. *The induced ∞ -functor*

$$N_h L \bar{C}^{\Delta^{\text{op}}} \rightarrow N_h L [C^{\text{op}}, \text{sSet}]_{\text{proj,loc}}$$

is an equivalence of ∞ -categories.

This is due to [NSS12b]. We prove this after noticing the following fact.

Proposition 2.2.18. *Let C be a category and \bar{C} its free coproduct completion.*

Every simplicial presheaf over C is equivalent in $[C^{\text{op}}, \text{sSet}]_{\text{proj}}$ to a simplicial object in \bar{C} (after the degreewise Yoneda embedding $j^{\Delta^{\text{op}}} : \bar{C}^{\Delta^{\text{op}}} \rightarrow [C^{\text{op}}, \text{sSet}]$).

If moreover C has pullbacks and sequential colimits, then the simplicial object in \bar{C} can be taken to be globally Kan, hence fibrant in $[C^{\text{op}}, \text{sSet}]_{\text{proj}}$.

Proof. The first statement is prop. 2.8 in [Dug01], which says that for every $X \in [C^{\text{op}}, \text{sSet}]$ the canonical morphism from the simplicial presheaf

$$(QX) : [k] \mapsto \coprod_{U_0 \rightarrow \cdots \rightarrow U_k \rightarrow X_k} j(U_0),$$

where the coproduct runs over all sequences of morphisms between representables U_i as indicated and using the evident face and degeneracy maps, is a global weak equivalence

$$QX \xrightarrow{\simeq} X.$$

The second statement follows by postcomposing with Kan's fibrant replacement functor (see for instance section 3 in [Jard87])

$$\mathrm{Ex}^\infty : \mathrm{sSet} \rightarrow \mathrm{KanCplx} \hookrightarrow \mathrm{sSet}.$$

This functor forms new simplices by subdivision, which only involves forming iterated pullbacks over the spaces of the original simplices. \square

Example 2.2.19. Let C be a category of *connected* topological spaces with given extra structure and properties (for instance smooth manifolds). Then \bar{C} is the category of all such spaces (with arbitrary many connected components).

Then the statement is that every ∞ -stack over C has a presentation by a simplicial object in \bar{C} . This is true with respect to any Grothendieck topology on C , since the weak equivalences in the global projective model structure that prop. 2.2.18 refers to remain weak equivalences in any left Bousfield localization.

If moreover C has all pullbacks (for instance for connected topological spaces, but not for smooth manifolds) then every ∞ -stack over C even has a presentation by a globally Kan simplicial object in \bar{C} .

Proof of theorem 2.2.17. Let $Q : [C^{\mathrm{op}}, \mathrm{sSet}] \rightarrow \bar{C}^{\Delta^{\mathrm{op}}}$ be Dugger's replacement functor from the proof of prop. 2.2.18. In [Dug01] it is shown that for all X the simplicial presheaf QX is cofibrant in $[C^{\mathrm{op}}, \mathrm{sSet}]_{\mathrm{proj}}$ and that the natural morphism $QX \rightarrow X$ is a weak equivalence. Since left Bousfield localization does not affect the cofibrations and only enlarges the weak equivalences, the same is still true in $[C^{\mathrm{op}}, \mathrm{sSet}]_{\mathrm{proj}, \mathrm{loc}}$.

Therefore we have a natural transformation

$$i \circ Q \rightarrow \mathrm{Id} : [C^{\mathrm{op}}, \mathrm{sSet}] \rightarrow [C^{\mathrm{op}}, \mathrm{sSet}]$$

whose components are weak equivalences. From this the claim follows by prop. 3.5 in [DwKa80a]. \square

Remark 2.2.20. If the site C is moreover equipped with the structure of a *geometry* as in [L-Geo] then there is canonically the notion of a *C-manifold*: a sheaf on C that is *locally* isomorphic to a representable in C . Write

$$\bar{C} \hookrightarrow \mathrm{CMfd} \hookrightarrow [C^{\mathrm{op}}, \mathrm{Set}]$$

for the full subcategory of presheaves on the C -manifolds.

Then the above argument applies verbatim also to the category $\mathrm{CMfd}^{\Delta^{\mathrm{op}}}$ of simplicial C -manifolds. Therefore we find that the ∞ -topos over C is presented by the simplicial localization of simplicial C -manifolds at the stalkwise weak equivalences:

$$\mathrm{Sh}_\infty(C) \simeq N_h \mathrm{LCMfd}^{\Delta^{\mathrm{op}}}.$$

Example 2.2.21. Let $C = \mathrm{CartSp}_{\mathrm{smooth}}$ be the full subcategory of the category $\mathrm{SmthMfd}$ of smooth manifolds on the Cartesian spaces, \mathbb{R}^n , for $n \in \mathbb{R}$. Then $\bar{C} \subset \mathrm{SmthMfd}$ is the full subcategory on manifolds that are disjoint unions of Cartesian spaces and $\mathrm{CMfd} \simeq \mathrm{SmthMfd}$. Therefore we have an equivalence of ∞ -categories

$$\mathrm{Sh}_\infty(\mathrm{SmthMfd}) \simeq \mathrm{Sh}_\infty(\mathrm{CartSp}) \simeq L \mathrm{SmthMfd}^{\Delta^{\mathrm{op}}}.$$

2.2.5 ∞ -Sheaves and descent

We discuss some details of the notion of ∞ -sheaves from the point of view of the presentations discussed above in 2.2.3.

By def. 2.2.1 we have, abstractly, that an ∞ -sheaf over some site C is an ∞ -presheaf that is in the essential image of a given reflective inclusion $\mathrm{Sh}_\infty(C) \hookrightarrow \mathrm{PSh}_\infty(C)$. By prop. 2.2.15 this reflective embedding is presented by the Quillen adjunction that exhibits the left Bousfield localization of the model category of simplicial presheaves at the Čech covers

$$\begin{array}{ccc} ([C^{\mathrm{op}}, \mathrm{sSet}]_{\mathrm{proj}, \mathrm{loc}})^\circ & \begin{array}{c} \xleftarrow{\mathrm{LId}} \\ \xrightarrow{\mathrm{RId}} \end{array} & ([C^{\mathrm{op}}, \mathrm{sSet}]_{\mathrm{proj}})^\circ \\ \downarrow \simeq & & \downarrow \simeq \\ \mathrm{Sh}_\infty(C) & \xleftarrow{L} & \mathrm{PSh}_\infty(C) \end{array}$$

Since the Quillen adjunction that exhibits left Bousfield localization is given by identity-1-functors, as indicated, the computation of ∞ -sheafification (∞ -stackification) L by deriving the left Quillen functor is all in the cofibrant replacement in $[C^{\mathrm{op}}, \mathrm{sSet}]_{\mathrm{proj}}$ followed by fibrant replacement in $[C^{\mathrm{op}}, \mathrm{sSet}]_{\mathrm{proj}, \mathrm{loc}}$. Since the collection of cofibrations is preserved by left Bousfield localization, this simply amounts to cofibrant-fibrant replacement in $[C^{\mathrm{op}}, \mathrm{sSet}]_{\mathrm{proj}, \mathrm{loc}}$. Since, finally, the derived hom space $\mathrm{Sh}_\infty(U, A)$ is computed in $[C^{\mathrm{op}}, \mathrm{sSet}]_{\mathrm{proj}, \mathrm{loc}}$ already on a fibrant resolution of A out of a cofibrant resolution of U , and since every representable is necessarily cofibrant, one may effectively identify the ∞ -sheaf condition in $\mathrm{PSh}_\infty(C)$ with the fibrancy condition in $[C^{\mathrm{op}}, \mathrm{sSet}]_{\mathrm{proj}, \mathrm{loc}}$.

We discuss aspects of this fibrancy condition.

Definition 2.2.22. For C a site, we say a covering family $\{U_i \rightarrow U\}$ is a *good cover* if the corresponding Čech nerve

$$C(U_i) := \int^{[k] \in \Delta} \prod_{i_0, \dots, i_k} j(U_{i_0}) \times_{j(U)} \cdots \times_{j(U)} j(U_{i_k}) \in [C^{\mathrm{op}}, \mathrm{sSet}]_{\mathrm{proj}}$$

(where $j : C \rightarrow [C^{\mathrm{op}}, \mathrm{sSet}]$ is the Yoneda embedding) is degreewise a coproduct of representables, hence if all non-empty finite intersections of the U_i are again representable:

$$j(U_{i_0, \dots, i_k}) = U_{i_0} \times_U \cdots \times_U U_{i_k}.$$

Proposition 2.2.23. *The Čech nerve $C(U_i)$ of a good cover is cofibrant in $[C^{\mathrm{op}}, \mathrm{sSet}]_{\mathrm{proj}}$ as well as in $[C^{\mathrm{op}}, \mathrm{sSet}]_{\mathrm{proj}, \mathrm{loc}}$.*

Proof. In the terminology of [DHS04] the good-ness condition on a cover makes its Čech nerve a *split hypercover*. By the result of [Dug01] this is cofibrant in $[C^{\mathrm{op}}, \mathrm{sSet}]_{\mathrm{proj}}$. Since left Bousfield localization preserves cofibrations, it is also cofibrant in $[C^{\mathrm{op}}, \mathrm{sSet}]_{\mathrm{proj}, \mathrm{loc}}$. \square

Definition 2.2.24. For A a simplicial presheaf with values in Kan complexes and $\{U_i \rightarrow U\}$ a good cover in the site C , we say that

$$\mathrm{Desc}(\{U_i\}, A) := [C^{\mathrm{op}}, \mathrm{sSet}](C(U_i), A),$$

where on the right we have the sSet -enriched hom of simplicial presheaves, is the *descent object* of A over $\{U_i \rightarrow U\}$.

Remark 2.2.25. By assumption A is fibrant and $C(U_i)$ is cofibrant (by prop. 2.2.23) in $[C^{\mathrm{op}}, \mathrm{sSet}]_{\mathrm{proj}}$. Since this is a simplicial model category, it follows that $\mathrm{Desc}(\{U_i\}, A)$ is a Kan complex, an ∞ -groupoid. We may also speak of the *descent ∞ -groupoid*. Below we show that its objects have the interpretation of *gluing data* or *descent data* for A . See [DHS04] for more details.

Proposition 2.2.26. *For C a site whose topology is generated from good covers, a simplicial presheaf A is fibrant in $[C^{\text{op}}, \text{sSet}]_{\text{proj,loc}}$ precisely if it takes values in Kan complexes and if for each generating good cover $\{U_i \rightarrow U\}$ the canonical morphism*

$$A(U) \rightarrow \text{Desc}(\{U_i\}, A)$$

is a weak equivalence of Kan complexes.

Proof. By standard results recalled in A.3.7 of [L-Topos] the fibrant objects in the local model structure are precisely those which are fibrant in the global model structure and which are *local* with respect to the morphisms at which one localizes: such that the derived hom out of these morphisms into the given object produces a weak equivalence.

By prop. 2.2.23 we have that $C(U_i)$ is cofibrant for $\{U_i \rightarrow U\}$ a good cover. Therefore the derived hom is computed already by the enriched hom as in the above statement. \square

Remark 2.2.27. The above condition manifestly generalizes the *sheaf* condition on an ordinary sheaf [Joh02]. One finds that

$$(\pi_0^{\text{PSh}}(C(U_i)) \rightarrow \pi_0^{\text{PSh}}(U)) = (S(U_i) \hookrightarrow U)$$

is the (subfunctor corresponding to the) *sieve* associated with the cover $\{U_i \rightarrow U\}$. Therefore when A is itself just a presheaf of sets (of simplicially constant simplicial sets) the above condition reduces to the statement that

$$A(U) \rightarrow [C^{\text{op}}, \text{Set}](S(U_i), A)$$

is an isomorphism. This is the standard sheaf condition.

We discuss the descent object, def. 2.2.24, in more detail.

Definition 2.2.28. Write

$$\text{coDesc}(\{U_i\}, A) \in \text{sSet}^\Delta$$

for the cosimplicial simplicial set that in degree k is given by the value of A on the k -fold intersections:

$$\text{coDesc}(\{U_i\}, A)_k = \prod_{i_0, \dots, i_k} A(U_{i_0, \dots, i_k}).$$

Proposition 2.2.29. *The descent object from def. 2.2.24 is the totalization of the codescent object:*

$$\begin{aligned} \text{Desc}(\{U_i\}, A) &= \text{tot}(\text{coDesc}(\{U_i\}, A)) \\ &:= \int_{[k] \in \Delta} \text{sSet}(\Delta[k], \text{coDesc}(\{U_i\}, A)_k) \end{aligned}$$

Here and in the following equality signs denote isomorphism (such as to distinguish from just weak equivalences of simplicial sets).

Proof. Using sSet-enriched category calculus for the sSet-enriched and sSet-tensored category of simplicial

presheaves (for instance [Ke82] around (3.67)) we compute as follow

$$\begin{aligned}
\text{Desc}(\{U_i\}, A) &:= [C^{\text{op}}, \text{sSet}](C(U_i), A) \\
&= [C^{\text{op}}, \text{sSet}]\left(\int^{[k] \in \Delta} \Delta[k] \cdot C(U_i)_k, A\right) \\
&= \int_{[k] \in \Delta} [C^{\text{op}}, \text{sSet}](\Delta[k] \cdot C(U_i), A) \\
&= \int_{[k] \in \Delta} \text{sSet}(\Delta[k], [C^{\text{op}}, \text{sSet}](C(U_i)_k), A) \\
&= \int_{[k] \in \Delta} \text{sSet}(\Delta[k], A(C(U_i)_k)) \\
&= \text{tot}(A(C(U_i)_\bullet)) \\
&= \text{tot}(\text{coDesc}(\{C(U_i)\}, A)) .
\end{aligned}$$

Here we used in the first step that every simplicial set Y (hence every simplicial presheaf) is the realization of itself, in that

$$Y = \int^{[k] \in \Delta} \Delta[k] \cdot Y_k,$$

which is effectively a variant of the Yoneda-lemma. \square

Remark 2.2.30. This provides a fairly explicit description of the objects in $\text{Desc}(\{U_i\}, A)$ by what is called *nonabelian Čech hypercohomology*.

Notice that an element c of the end $\int_{[k] \in \Delta} \text{sSet}(\Delta[k], \text{coDesc}(\{U_i\}, A))$ is by definition of *ends* a collection of morphisms

$$\{c_k : \Delta[k] \rightarrow \prod_{i_0, \dots, i_k} A_k(U_{i_0, \dots, i_k})\}$$

that makes commuting all parallel diagrams in the following:

$$\begin{array}{ccc}
\begin{array}{c} \vdots \\ \Delta[2] \end{array} & \xrightarrow{c_2} & \begin{array}{c} \vdots \\ \prod_{i_0, i_1, i_2} A(U_{i_0, i_1, i_2}) \end{array} \\
\begin{array}{c} \uparrow \uparrow \uparrow \uparrow \\ \Delta[1] \end{array} & \xrightarrow{c_1} & \begin{array}{c} \uparrow \uparrow \uparrow \uparrow \\ \prod_{i_0, i_1} A(U_{i_0, i_1}) \end{array} \\
\begin{array}{c} \uparrow \uparrow \\ \Delta[0] \end{array} & \xrightarrow{c_0} & \begin{array}{c} \uparrow \uparrow \\ \prod_{i_0} A(U_{i_0}) \end{array}
\end{array}$$

This says in words that c is

1. a collection of objects $a_i \in A(U_i)$ on each patch;
2. a collection of morphisms $\{g_{ij} \in A_1(U_{ij})\}$ over each double intersection, such that these go between the restrictions of the objects a_i and a_j , respectively

$$a_i|_{U_{ij}} \xrightarrow{g_{ij}} a_j|_{U_{ij}}$$

3. a collection of 2-morphisms $\{h_{ijk} \in A_2(U_{ijk})\}$ over triple intersections, which go between the corresponding 1-morphisms:

$$\begin{array}{ccc}
 & a_j|_{U_{ijk}} & \\
 g_{ij}|_{U_{ijk}} \nearrow & \Downarrow h_{ijk} & \searrow g_{jk}|_{U_{ijk}} \\
 a_i|_{U_{ijk}} & \xrightarrow{g_{ik}|_{U_{ijk}}} & a_k|_{U_{ijk}}
 \end{array} ,$$

4. a collection of 3-morphisms $\{\lambda_{ijkl} \in A_3(U_{ijkl})\}$ of the form

$$\begin{array}{ccc}
 a_j|_{U_{ijkl}} \xrightarrow{g_{jk}|_{U_{ijkl}}} a_k|_{U_{ijkl}} & & a_j|_{U_{ijkl}} \xrightarrow{g_{jk}|_{U_{ijkl}}} a_j|_{U_{ijkl}} \\
 \uparrow g_{ij}|_{U_{ijkl}} \quad \searrow h_{ijk}|_{U_{ijkl}} \quad \nearrow h_{ikl}|_{U_{ijkl}} & \xrightarrow{\lambda_{ijkl}} & \uparrow g_{ij}|_{U_{ijkl}} \quad \searrow h_{ijl}|_{U_{ijkl}} \quad \nearrow h_{jkl}|_{U_{ijkl}} \\
 a_i|_{U_{ijkl}} \xrightarrow{g_{ik}|_{U_{ijkl}}} a_l|_{U_{ijkl}} & & a_i|_{U_{ijkl}} \xrightarrow{g_{il}|_{U_{ijkl}}} a_l|_{U_{ijkl}}
 \end{array} ;$$

5. and so on.

This recovers the cocycle diagrams that we have discussed more informally in 1.2.5 and generalizes them to arbitrary coefficient objects A .

2.2.6 ∞ -Sheaves with values in chain complexes

Many simplicial presheaves appearing in practice are (equivalent to) objects in sub- ∞ -categories of $\text{Sh}_\infty(C)$ of ∞ -sheaves with values in abelian or at least in “strict” ∞ -groupoids. These subcategories typically offer convenient and desirable contexts for formulating and proving statements about special cases of general simplicial presheaves.

One well-known such notion is given by the *Dold-Kan correspondence* (discussed for instance in [GoJa99]). This identifies chain complexes of abelian groups with strict and strictly symmetric monoidal ∞ -groupoids.

Proposition 2.2.31. *Let $\text{Ch}_{\text{proj}}^+$ be the standard projective model structure on chain complexes of abelian groups in non-negative degree and let sAb_{proj} be the standard projective model structure on simplicial abelian groups. Let C be any small category. There is a composite Quillen adjunction*

$$((N_\bullet F)_* \dashv \Xi) : [C^{\text{op}}, \text{Ch}_{\text{proj}}^+]_{\text{proj}} \xrightleftharpoons[\Gamma_*]{(N_\bullet)_*} [C^{\text{op}}, \text{sAb}_{\text{proj}}]_{\text{proj}} \xrightleftharpoons[U_*]{F_*} [C^{\text{op}}, \text{sSet}_{\text{Quillen}}]_{\text{proj}} ,$$

where the first is given by postcomposition with the Dold-Puppe-Kan correspondence and the second by postcomposition with the degreewise free-forgetful adjunction for abelian groups over sets.

We also write $\text{DK} := \Xi$ for this Dold-Kan map. Dropping the condition on symmetric monoidalness we obtain a more general such inclusion, a kind of non-abelian Dold-Kan correspondence: the identification of *crossed complexes*, def. 1.2.89, with strict ∞ -groupoids (see [BrHiSi11][Por] for details).

Definition 2.2.32. A *globular set* X is a collection of sets $\{X_n\}_{n \in \mathbb{N}}$ equipped with functions $\{s_n, t_n : X_{n+1} \rightarrow X_n\}_{n \in \mathbb{N}}$ such that $\forall n \in \mathbb{N} (s_n \circ s_{n+1} = s_n \circ t_{n+1})$ and $\forall n \in \mathbb{N} (t_n \circ s_{n+1} = t_n \circ t_{n+1})$. (These relations ensure that for every pair $k_1 < k_2 \in \mathbb{N}$ there are uniquely defined functions $s, t : X_{k_2} \rightarrow X_{k_1}$.) A *strict*

∞ -groupoid is a globular set X_\bullet equipped for each $k \geq 1$ with the structure of a groupoid on $X_k \xrightleftharpoons[t]{s} X_0$ such that for all $k_1 < k_2 \in \mathbb{N}$ this induces the structure of a strict 2-groupoid on

$$X_{k_2} \xrightleftharpoons[t]{s} X_{k_1} \xrightleftharpoons[t]{s} X_0 .$$

Remark 2.2.33. We have a sequence of (non-full) inclusions

$$\begin{array}{ccccc}
\text{ChainComplex} & \longrightarrow & \text{CrossedComplex} & \longrightarrow & \text{KanComplex} \\
\downarrow \simeq & & \downarrow \simeq & & \downarrow \simeq \\
\text{StrAbStr}\infty\text{Grpd} & \longrightarrow & \text{Str}\infty\text{Grpd} & \longrightarrow & \infty\text{Grpd}
\end{array}$$

of strict ∞ -groupoids into all ∞ -groupoids, where in the top row we list the explicit presentation and in the bottom row the abstract notions.

We state a useful theorem for the computation of descent for presheaves, prop. 2.2.26, with values in strict ∞ -groupoids.

Suppose that $\mathcal{A} : C^{\text{op}} \rightarrow \text{Str}\infty\text{Grpd}$ is a presheaf with values in strict ∞ -groupoids. In the context of strict ∞ -groupoids the standard n -simplex is given by the n th *oriental* $O(n)$ [Stre04]. This allows us to perform a construction that looks like a descent object in $\text{Str}\infty\text{Grpd}$:

Definition 2.2.34 (Street 04). The descent object for $\mathcal{A} \in [C^{\text{op}}, \text{Str}\infty\text{Grpd}]$ relative to $Y \in [C^{\text{op}}, \text{sSet}]$ is

$$\text{Desc}_{\text{Street}}(Y, \mathcal{A}) := \int_{[n] \in \Delta} \text{Str}\infty\text{Cat}(O(n), \mathcal{A}(Y_n)) \in \text{Str}\infty\text{Grpd},$$

where the end is taken in $\text{Str}\infty\text{Grpd}$.

This object had been suggested by Ross Street to be the right descent object for strict ∞ -category-valued presheaves in [Stre04].

Canonically induced by the orientals is the ω -nerve

$$N : \text{Str}\omega\text{Cat} \rightarrow \text{sSet}$$

Applying this to the descent object of prop. 2.2.34 yields the simplicial set $N\text{Desc}(Y, \mathcal{A})$. On the other hand, applying the ω -nerve componentwise to \mathcal{A} yields a simplicial presheaf $N\mathcal{A}$ to which the ordinary simplicial descent from def. 2.2.24 applies. The following theorem asserts that under certain conditions the ∞ -groupoids presented by both these simplicial sets are equivalent.

Proposition 2.2.35 (Verity 09). *If $\mathcal{A} : C^{\text{op}}, \text{Str}\infty\text{Grpd}$ and $Y : C^{\text{op}} \rightarrow \text{sSet}$ are such that $N\mathcal{A}(Y_{\bullet}) : \Delta \rightarrow \text{sSet}$ is fibrant in the Reedy model structure $[\Delta, \text{sSet}_{\text{Quillen}}]_{\text{Reedy}}$, then*

$$N\text{Desc}_{\text{Street}}(Y, \mathcal{A}) \xrightarrow{\simeq} \text{Desc}(Y, N\mathcal{A})$$

is a weak homotopy equivalence of Kan complexes.

This is proven in [Veri09]. In our applications the assumptions of this theorem are usually satisfied:

Corollary 2.2.36. *If $Y \in [C^{\text{op}}, \text{sSet}]$ is such that $Y_{\bullet} : \Delta \rightarrow [C^{\text{op}}, \text{Set}] \hookrightarrow [C^{\text{op}}, \text{sSet}]$ is cofibrant in $[\Delta, [C^{\text{op}}, \text{sSet}]_{\text{proj}}]_{\text{Reedy}}$ then for $\mathcal{A} : C^{\text{op}} \rightarrow \text{Str}\infty\text{Grpd}$ we have a weak equivalence*

$$N\text{Desc}(Y, \mathcal{A}) \xrightarrow{\simeq} \text{Desc}(Y, N\mathcal{A}).$$

Proof. If Y_{\bullet} is Reedy cofibrant, then by definition the canonical morphisms

$$\lim_{\rightarrow} (([n] \xrightarrow{\pm} [k]) \mapsto Y_k) \rightarrow Y_n$$

are cofibrations in $[C^{\text{op}}, \text{sSet}]_{\text{proj}}$. Since the latter is an $\text{sSet}_{\text{Quillen}}$ -enriched model category and $N\mathcal{A}$ is fibrant in $[C^{\text{op}}, \text{sSet}]_{\text{proj}}$, it follows that the hom-functor $[C^{\text{op}}, \text{sSet}](-, N\mathcal{A})$ sends cofibrations to fibrations, so that

$$N\mathcal{A}(Y_n) \rightarrow \lim_{\leftarrow} (([n] \xrightarrow{\pm} [k]) \mapsto N\mathcal{A}(Y_k))$$

is a Kan fibration. But this says that $N\mathcal{A}(Y_{\bullet})$ is Reedy fibrant, so that the assumption of prop. 2.2.35 is met. \square

2.3 Universal constructions

We discuss some basic abstract properties and some presentations of universal constructions in ∞ -category theory that we will refer to frequently.

2.3.1 General abstract

2.3.1.1 ∞ -Colimits in ∞Grpd The following proposition says that every ∞ -groupoid is the ∞ -colimit over itself, regarded as a diagram, of the ∞ -functor constant on the point in ∞Grpd .

Proposition 2.3.1. *For $S \in \infty\text{Grpd}$, the ∞ -colimit of the ∞ -functor $S \rightarrow \infty\text{Grpd}$ constant on the terminal object is equivalent to S :*

$$\lim_{\rightarrow S} * \simeq S.$$

This is essentially corollary 4.4.4.9 in [L-Topos].

2.3.1.2 ∞ -Pullbacks We will have have ample application for the following immediate ∞ -category theoretic generalization of a basic 1-categorical fact.

Proposition 2.3.2 (pasting law for ∞ -pullbacks). *Let*

$$\begin{array}{ccccc} a & \longrightarrow & b & \longrightarrow & c \\ \downarrow & & \downarrow & & \downarrow \\ d & \longrightarrow & e & \longrightarrow & f \end{array}$$

be a diagram in an ∞ -category and suppose that the right square is an ∞ -pullback. Then the left square is an ∞ -pullback precisely if the outer rectangle is.

This appears as [L-Topos], lemma 4.4.2.1. Notice that here and in the following we do not explicitly display the 2-morphisms/homotopies that do fill these diagrams in the given ∞ -category.

2.3.1.3 Effective epimorphisms We briefly record the definition and main properties of effective epimorphisms in an ∞ -topos from [L-Topos], section 6.2.3.

Definition 2.3.3. A morphism $Y \rightarrow X$ in an ∞ -topos is an *effective epimorphism* if it exhibits the ∞ -colimit over the simplicial diagram that is its Čech nerve:

$$Y \simeq \lim_{\rightarrow_n} Y^{\times_n X}.$$

See for instance below cor. 6.2.3.5 in [L-Topos].

Remark 2.3.4. In view of the discussion of groupoid objects below in 3.6.7 (see remark 3.6.91 there) we also speak of an effective epimorphism $U \twoheadrightarrow X$ as being an *atlas*, or, more explicitly, as *exhibiting U as an atlas of X* .

Proposition 2.3.5. *Effective epimorphisms are preserved by ∞ -pullback.*

This is prop. 6.2.3.15 in [L-Topos].

Proposition 2.3.6.

A morphism $p : X \rightarrow Y$ is an effective epimorphism precisely if its 0-truncation $\tau_0 p : \tau_0 X \rightarrow \tau_0 Y$, def. 3.6.22, is an effective epimorphism, hence an epimorphism, in the 1-topos of 0-truncated objects.

This is prop. 7.2.1.14 in [L-Topos].

Example 2.3.7. A morphism in ∞Grpd is effective epi precisely if it induces an epimorphism $\pi_0(X) \rightarrow \pi_0(Y)$ of sets of connected components.

2.3.2 Presentations

We discuss presentations of various classes of ∞ -limits and ∞ -colimits in an ∞ -category by *homotopy limits* and *homotopy colimits* in categories with weak equivalences presenting them.

2.3.2.1 ∞ -Pullbacks We discuss here tools for computing ∞ -pullbacks in an ∞ -category \mathbf{H} in terms of homotopy pullbacks in a homotopical 1-category presenting it.

Proposition 2.3.8. *Let $A \rightarrow C \leftarrow B$ be a cospan diagram in a model category, def. 2.1.27. Sufficient conditions for the ordinary pullback $A \times_C B$ to be a homotopy pullback are*

- one of the two morphisms is a fibration and all three objects are fibrant;
- one of the two morphisms is a fibration and the model structure is right proper.

This appears for instance as prop. A.2.4.4 in [L-Topos].

It remains to have good algorithms for identifying fibrations and for resolving morphisms by fibrations. A standard recipe for constructing fibration resolutions is

Proposition 2.3.9 (factorization lemma). *Let $B \rightarrow C$ be a morphism between fibrant objects in a model category and let $C \xrightarrow{\simeq} C^I \twoheadrightarrow C \times C$ be a path object for B . Then the composite vertical morphism in*

$$\begin{array}{ccc}
 C^I \times_C B & \longrightarrow & B \\
 \downarrow & & \downarrow \\
 C^I & \longrightarrow & C \\
 \downarrow & & \\
 C & &
 \end{array}$$

is a fibration replacement of $B \rightarrow C$.

This appears for instance on p. 4 of [Br73].

Corollary 2.3.10. *For $A \rightarrow C \leftarrow B$ a diagram of fibrant objects in a model category, its homotopy pullback is presented by the ordinary limit $A \times_C^h B$ in*

$$\begin{array}{ccccc}
 A \times_C^h B & \longrightarrow & C^I \times_C B & \longrightarrow & B \\
 \downarrow & & \downarrow & & \downarrow \\
 & & C^I & \longrightarrow & C \\
 \downarrow & & \downarrow & & \\
 A & \longrightarrow & C & &
 \end{array}$$

which is, up to isomorphism, the same as the ordinary pullback in

$$\begin{array}{ccc}
 A \times_C^h B & \longrightarrow & C^I \\
 \downarrow & & \downarrow \\
 A \times B & \longrightarrow & C \times C
 \end{array}$$

Remark 2.3.11. For the special case of “abelian” objects another useful way of constructing fibrations is via the *Dold-Kan correspondence*, which we discuss in 2.2.6. As described there, a morphism between simplicial presheaves that arise from presheaves of chain complexes is a fibration (in the projective model structure on simplicial presheaves) if it arises from a degreewise surjection of chain complexes.

2.3.2.2 Finite ∞ -limits of ∞ -sheaves We discuss presentations for finite ∞ -limits specifically in ∞ -toposes.

Proposition 2.3.12. *Let C be a site with enough points, def. 2.2.9. Write $\mathbf{H} \simeq (\mathrm{Sh}(C)^{\Delta^{\mathrm{op}}}, W)$ for the hypercomplete ∞ -topos over C , where W is the class of local weak equivalences, theorem 2.2.12.*

Then pullbacks in $\mathrm{Sh}(C)^{\Delta^{\mathrm{op}}}$ along local fibrations, def. 2.2.13, are homotopy pullbacks, hence present ∞ -pullbacks in \mathbf{H} .

Proof. Let $A \xrightarrow{\mathrm{loc}} C \longleftarrow B$ be a cospan with the left leg a local fibration. By the existence of the projective local model structure $[C^{\mathrm{op}}, \mathrm{sSet}]_{\mathrm{proj}, \mathrm{loc}}$ there exists a morphism of diagrams

$$\begin{array}{ccccc} A & \xrightarrow{\mathrm{loc}} & C & \longleftarrow & B \\ \downarrow \simeq & & \downarrow \simeq & & \downarrow \simeq \\ A' & \longrightarrow & C' & \longleftarrow & B' \end{array},$$

where the bottom cospan is a fibrant diagram with respect to the projective local model structure, hence a cospan of genuine fibrations between fibrant objects, so that the ordinary pullback $A' \times_{C'} B'$ is a presentation of the homotopy pullback of the original diagram. Here the vertical morphisms are weak equivalences, and by theorem 2.2.12 this means that they are stalkwise weak equivalences of simplicial sets. Moreover, by the nature of left Bousfield localization, the genuine fibrations are in particular global projective fibrations, hence in particular are stalkwise fibrations.

Now for $p : \mathrm{Set} \rightarrow \mathrm{Sh}(C)$ any topos point, the stalk functor p^* preserves finite limits and hence preserves (the sheafification of) the above pullbacks. So by the assumption that $A \rightarrow C$ is a local fibration, the simplicial set $p^*(A \times_C B)$ is a pullback of simplicial sets along a Kan fibration, hence, by the right properness of $\mathrm{sSet}_{\mathrm{Quillen}}$, and using prop. 2.3.8, is a homotopy pullback there. Moreover, the induced morphism $p^*(A \times_C B) \rightarrow p^*(A' \times_{C'} B')$ is therefore a morphism of homotopy pullbacks along a weak equivalence of diagrams. This means that it is itself a weak equivalence. Since this is true for all topos points, it follows that $A \times_C B \rightarrow A' \times_{C'} B'$ is a stalkwise weak equivalence, hence a weak equivalence, hence that $A \times_C B$ is itself already a model for the homotopy pullback. \square

The following proposition establishes the model category analog of the statement that by left exactness of ∞ -sheafification, finite ∞ -limits of ∞ -sheafified ∞ -presheaves may be computed as the ∞ -sheafification of the finite ∞ -limit of the ∞ -presheaves.

Proposition 2.3.13. *Let C be a site and $F : D \rightarrow [C^{\mathrm{op}}, \mathrm{sSet}]$ be a finite diagram.*

Write $\mathbb{R}_{\mathrm{glob}} \lim_{\leftarrow} F \in [C^{\mathrm{op}}, \mathrm{sSet}]$ for (any representative of) the homotopy limit over F computed in the global model structure $[C^{\mathrm{op}}, \mathrm{sSet}]_{\mathrm{proj}}$, well defined up to isomorphism in the homotopy category.

Then $\mathbb{R}_{\mathrm{glob}} \lim_{\leftarrow} F \in [C^{\mathrm{op}}, \mathrm{sSet}]$ presents also the homotopy limit of F in the local model structure $[C^{\mathrm{op}}, \mathrm{sSet}]_{\mathrm{proj}, \mathrm{loc}}$.

Proof. By [L-Topos], theorem 4.2.4.1, we have that the homotopy limit $\mathbb{R} \lim_{\leftarrow}$ computes the corresponding ∞ -limit. Since ∞ -sheafification L is by definition a left exact ∞ -functor it preserves these finite ∞ -limits:

$$\begin{array}{ccc} ([D, [C^{\mathrm{op}}, \mathrm{sSet}]_{\mathrm{proj}, \mathrm{loc}}]_{\mathrm{inj}})^{\circ} & \xleftarrow{L_*} & ([D, [C^{\mathrm{op}}, \mathrm{sSet}]_{\mathrm{proj}}]_{\mathrm{inj}})^{\circ} \\ \downarrow \mathbb{R} \lim_{\leftarrow} & & \downarrow \mathbb{R} \lim_{\leftarrow} \\ ([C^{\mathrm{op}}, \mathrm{sSet}]_{\mathrm{proj}, \mathrm{loc}})^{\circ} & \xleftarrow{L \simeq \mathbb{L} \mathrm{Id}} & ([C^{\mathrm{op}}, \mathrm{sSet}]_{\mathrm{proj}})^{\circ} \end{array}$$

Here $L \simeq \mathbb{L} \mathrm{Id}$ is the left derived functor of the identity for the left Bousfield localization. Therefore for F a finite diagram in simplicial presheaves, its homotopy limit in the local model structure $\mathbb{R} \lim_{\leftarrow} L_* F$ is equivalently computed by $\mathbb{L} \mathrm{Id} \mathbb{R} \lim_{\rightarrow} F$, with $\mathbb{R} \lim_{\leftarrow} F$ the homotopy limit in the global model structure. \square

Together with 2.3.2.1, this provides an efficient algorithm for computing presentations of ∞ -pullbacks in a model structure on simplicial presheaves.

Remark 2.3.14. Taken together, prop. 2.3.13, prop. 2.3.8 and definition 2.2.6 imply that we may compute ∞ -pullbacks in an ∞ -topos by the following algorithm:

1. Present the ∞ -topos by a local *projective* model structure on simplicial presheaves;
2. find a presentation of the morphisms to be pulled back such that one of them is over each object of the site a Kan fibration of simplicial sets;
3. then form the ordinary pullback of simplicial presheaves, which in turn is over each object the ordinary pullback of simplicial sets.

The resulting object presents the ∞ -pullback of ∞ -sheaves.

2.3.2.3 ∞ -Colimits We collect some standard facts and tools concerning the computation of homotopy colimits.

Proposition 2.3.15. *Let C be a combinatorial model category and let J be a small category. Then the colimit over J -diagrams in C is a left Quillen functor for the projective model structure on functors on J :*

$$\lim_{\longrightarrow} : [J, C]_{\text{proj}} \rightarrow C .$$

Proof. For C combinatorial, the projective model structure exists by [L-Topos] prop. A.2.8.2. The right adjoint to the colimit

$$\text{const} : C \rightarrow [J, C]_{\text{proj}}$$

is manifestly right Quillen for the projective model structure. □

Example 2.3.16. Write

$$(\mathbb{N}, \leq) := \{ 0 \longrightarrow 1 \longrightarrow 2 \longrightarrow \dots \}$$

for the *cotower category*. A cotower $X_0 \rightarrow X_1 \rightarrow X_2 \rightarrow \dots$ in a model category C is projectively cofibrant precisely if

1. every morphism $X_i \rightarrow X_{i+1}$ is a cofibration in C ;
2. the first object X_0 , and hence all objects X_i , are cofibrant in C .

Therefore a sequential ∞ -colimit over a cotower is presented by the ordinary colimit of a presentation of this cotower where all morphisms are cofibrations and all objects are cofibrant.

This is a simple example, but since we will need details of this at various places, we spell out the proof for the record.

Proof. Given a cotower X_{\bullet} with properties as stated, we need to check that for $p_{\bullet} : A_{\bullet} \rightarrow B_{\bullet}$ a morphism of cotowers such that for all $n \in \mathbb{N}$ the morphism $p_n : A_n \rightarrow B_n$ is an acyclic fibration in C , and for $f_{\bullet} : X_{\bullet} \rightarrow B_{\bullet}$ any morphism, there is a lift \hat{f}_{\bullet} in

$$\begin{array}{ccc} & & A_{\bullet} \\ & \nearrow \hat{f}_{\bullet} & \downarrow p_{\bullet} \\ X_{\bullet} & \xrightarrow{f_{\bullet}} & B_{\bullet} \end{array} .$$

This lift we can construct by induction on n . For $n = 0$ we only need a lift in

$$\begin{array}{ccc} & & A_0 \\ & \nearrow \hat{f}_0 & \downarrow p_0 \\ X_0 & \xrightarrow{f_0} & B_0 \end{array},$$

which exists by assumption that X_0 is cofibrant. Assume then that a lift has been for $f_{\leq n}$. Then the next lift \hat{f}_{n+1} needs to make the diagram

$$\begin{array}{ccccc} & & A_n & & \\ & \nearrow \hat{f}_n & \downarrow & \searrow & \\ X_n & \xrightarrow{\quad} & B_n & & A_{n+1} \\ & \searrow & & \nearrow \hat{f}_{n+1} & \downarrow \\ & & X_{n+1} & \xrightarrow{f_{n+1}} & B_{n+1} \end{array}$$

commute. Such a lift exists now by assumption that $X_n \rightarrow X_{n+1}$ is a cofibration.

Conversely, assume that X_\bullet is projectively cofibrant. Then first of all it has the left lifting property against all cotower morphisms of the form

$$\begin{array}{ccccccc} A_0 & \longrightarrow & * & \longrightarrow & * & \longrightarrow & \cdots \\ \downarrow \simeq & & \downarrow & & \downarrow & & \\ B_0 & \longrightarrow & * & \longrightarrow & * & \longrightarrow & \cdots \end{array}$$

Such a lift is equivalent to a lift of X_0 against $A_0 \xrightarrow{\simeq} B_0$ and hence X_0 is cofibrant in C . To see that every morphism $X_n \rightarrow X_{n+1}$ is a cofibration, notice that for every lifting problem in C of the form

$$\begin{array}{ccc} X_n & \longrightarrow & A \\ \downarrow & & \downarrow \simeq \\ X_{n+1} & \longrightarrow & B \end{array}$$

the cotower lifting problem of the form

$$\begin{array}{ccccccccccc} X_0 & \longrightarrow & \cdots & \longrightarrow & X_n & \longrightarrow & A & \longrightarrow & * & \longrightarrow & * & \longrightarrow & \cdots \\ \parallel & & & & \parallel & & \downarrow & & \parallel & & \parallel & & \\ X_0 & \longrightarrow & \cdots & \longrightarrow & X_n & \longrightarrow & B & \longrightarrow & * & \longrightarrow & * & \longrightarrow & \cdots \\ \parallel & & & & \parallel & & \nearrow & & & & & & \\ X_0 & \longrightarrow & \cdots & \longrightarrow & X_n & \longrightarrow & X_{n+1} & \longrightarrow & \cdots & & & & \end{array}$$

is equivalent. □

For less trivial diagram categories it quickly becomes hard to obtain projective cofibrant resolutions. In these cases it is often useful to compute the (homotopy) colimit instead as a special case of a (homotopy) coend.

Proposition 2.3.17. *Let $F : A \times B \rightarrow C$ be a Quillen bifunctor, def. 2.1.30, and let J be a Reedy category, then the coend over F (see [Ke82])*

$$\int^S F(-, -) : [J, A]_{\text{Reedy}} \times [J^{\text{op}}, B]_{\text{Reedy}} \rightarrow C$$

is a Quillen bifunctor from the product of the Reedy model categories on functors with values in A and B , respectively, to C .

Similarly, if A and B are combinatorial model categories and J is any small category, then the coend

$$\int^S F(-, -) : [J, A]_{\text{proj}} \times [J^{\text{op}}, B]_{\text{inj}} \rightarrow C$$

is a Quillen bifunctor.

This appears in [L-Topos] as prop. A.2.9.26 and remark A.2.9.27.

Proposition 2.3.18. *If \mathcal{V} is a closed monoidal model category, C is a \mathcal{V} -enriched model category, and J is a small category which is Reedy, then the homotopy colimit of J -shaped diagrams in C is presented by the left derived functor of*

$$\int^J (-) \cdot Q_{\text{Reedy}}(I) : [J, C]_{\text{Reedy}} \rightarrow C,$$

where $Q_{\text{Reedy}}(I)$ is a cofibrant replacement of the functor constant in the tensor unit in $[J^{\text{op}}, \mathcal{V}]_{\text{Reedy}}$, and where

$$(-) \cdot (-) : C \times \mathcal{V} \rightarrow C$$

is the given \mathcal{V} -tensoring of C . Similarly, if J is not necessarily Reedy, but \mathcal{V} and C are combinatorial, then the homotopy colimit is also given by the left derived functor of

$$\int^J (-) \cdot Q_{\text{proj}}(I) : [J, C]_{\text{inj}} \rightarrow C,$$

where now $Q_{\text{proj}}(I)$ is a cofibrant resolution of the tensor unit in $[J^{\text{op}}, \mathcal{V}]_{\text{proj}}$.

This is nicely discussed in [Gam10].

Proof. By definition of enriched category, the \mathcal{V} -tensoring operation is a left Quillen bifunctor. With this the statement follows from prop. 2.3.17. \square

Various classical facts of model category theory are special cases of these formulas.

2.3.2.4 ∞ -Colimits over simplicial diagrams We discuss here a standard presentation of *homotopy colimits over simplicial diagrams* given by the *diagonal simplicial set* or the *total simplicial set* associated with a bisimplicial set.

Proposition 2.3.19. *Write $[\Delta, \text{sSet}]$ for the category of cosimplicial simplicial sets. For sSet equipped with its cartesian monoidal structure, the tensor unit is the terminal object $*$.*

- The simplex functor

$$\Delta : [n] \mapsto \Delta[n] := \Delta(-, [n])$$

is a cofibrant resolution of $$ in $[\Delta, \text{sSet}_{\text{Quillen}}]_{\text{Reedy}}$;*

- the fat simplex functor

$$\mathbf{\Delta} : [n] \mapsto N(\Delta/[n])$$

is a cofibrant resolution of $$ in $[\Delta, \text{sSet}_{\text{Quillen}}]_{\text{proj}}$.*

Proposition 2.3.20. *Let C be a simplicial model category and $F : \Delta^{\text{op}} \rightarrow C$ a simplicial diagram*

1. *If every monomorphism in C is a cofibration, then the homotopy colimit over F is given by the realization*

$$\mathbb{L} \lim_{\rightarrow} F \simeq \int^{[n] \in \Delta} F([n]) \cdot \Delta[n].$$

2. *If F takes values in cofibrant objects, then the homotopy colimit over F is given by the fat realization*

$$\mathbb{L} \lim_{\rightarrow} F \simeq \int^{[n] \in \Delta} F([n]) \cdot \mathbf{\Delta}[n].$$

3. *If F is Reedy cofibrant, then the canonical morphism*

$$\int^{[n] \in \Delta} F([n]) \cdot \mathbf{\Delta}[n] \rightarrow \int^{[n] \in \Delta} F([n]) \cdot \Delta[n]$$

(the Bousfield-Kan map) *is a weak equivalence.*

Proof. If every monomorphism is a cofibration, then F is necessarily cofibrant in $[\Delta^{\text{op}}, C]_{\text{Reedy}}$. The first statement then follows from prop. 2.3.18 and the first item in prop. 2.3.19. On the other hand, if F takes values in cofibrant objects, then it is cofibrant in $[\Delta^{\text{op}}, C]_{\text{inj}}$, and so the second statement follows from prop. 2.3.18 and the second item in prop. 2.3.19.

Notice that projective cofibrancy implies Reedy cofibrancy, so that $\mathbf{\Delta}$ is also Reedy cofibrant. Therefore the morphism in the last item of the proposition is, by remark 2.1.31, the image under a left Quillen functor of a weak equivalence between cofibrant objects and therefore itself a weak equivalence. \square

An important example of this general situation is the following.

Proposition 2.3.21. *Every simplicial set, and more generally every simplicial presheaf is the homotopy colimit over its simplicial diagram of cells. Precisely, let C be a small site, and let $[C^{\text{op}}, \text{sSet}_{\text{Quillen}}]_{\text{inj,loc}}$ be the corresponding local injective model structure on simplicial presheaves. Then for any $X \in [C^{\text{op}}, \text{sSet}]$, with*

$$X_{\bullet} : \Delta^{\text{op}} \rightarrow [C^{\text{op}}, \text{Set}] \hookrightarrow [C^{\text{op}}, \text{sSet}_{\text{Quillen}}]$$

its simplicial diagram of components, we have

$$X \simeq \mathbb{L} \lim_{\rightarrow} X_{\bullet}.$$

Proof. By prop. 2.3.20 the homotopy colimit is given by the coend

$$\mathbb{L} \lim_{\rightarrow} X_{\bullet} \simeq \int^{[n] \in \Delta} X_n \times \Delta[n].$$

By basic properties of the coend, this is isomorphic to X . \square

Proposition 2.3.22. *The homotopy colimit of a simplicial diagram in $\text{sSet}_{\text{Quillen}}$, or more generally of a simplicial diagram of simplicial presheaves, is given by the diagonal of the corresponding bisimplicial set / bisimplicial presheaf.*

More precisely, for

$$F : \Delta^{\text{op}} \rightarrow [C^{\text{op}}, \text{sSet}_{\text{Quillen}}]_{\text{inj,log}}$$

a simplicial diagram, its homotopy colimit is given by

$$\mathbb{L} \lim_{\rightarrow} F_{\bullet} \simeq dF : ([n] \mapsto (F_n)_n).$$

Proof. By prop. 2.3.20 the homotopy colimit is given by the coend

$$\mathbb{L} \lim_{\rightarrow} F_{\bullet} \simeq \int^{[n] \in \Delta} F_n \cdot \Delta[n].$$

By a standard fact (e.g. exercise 1.6 in [GoJa99]), this coend is in fact isomorphic to the diagonal. \square

Definition 2.3.23. Write Δ_a for the *augmented simplex category*, which is the simplex category with an initial object adjoined, denoted $[-1]$.

This is a symmetric monoidal category with tensor product being the *ordinal sum* operation

$$[k], [l] \mapsto [k + l + 1].$$

Write

$$\sigma : \Delta \times \Delta \rightarrow \Delta$$

for the restriction of this tensor product along the canonical inclusion $\Delta \hookrightarrow \Delta_a$. Write

$$\sigma^* : \mathbf{sSet} \rightarrow [\Delta^{\text{op}}, \mathbf{sSet}]$$

for the operation of precomposition with this functor. By right Kan extension this induces an adjoint pair of functors

$$(\text{Dec} \dashv T) : [\Delta^{\text{op}}, \mathbf{sSet}] \begin{array}{c} \xleftarrow{\sigma^*} \\ \xrightarrow{\sigma_*} \end{array} \mathbf{sSet} .$$

- $\text{Dec} := \sigma^*$ is called the *total décalage* functor;
- $T := \sigma_*$ is called the *total simplicial set* functor.

The total simplicial set functor was introduced in [ArMa66]. Details are in [St11].

Remark 2.3.24. By definition, for $X \in [\Delta^{\text{op}}, \mathbf{sSet}]$, its total décalage is the bisimplicial set given by

$$(\text{Dec}X)_{k,l} = X_{k+l+1} .$$

Remark 2.3.25. For $X \in [\Delta^{\text{op}}, \mathbf{sSet}]$, the simplicial set TX is in each degree given by an equalizer of maps between finite products of components of X . Hence forming T is compatible with sheafification and other processes that preserve finite limits.

See [St11], equation (2).

Proposition 2.3.26. For every $X \in [\Delta^{\text{op}}, \mathbf{sSet}]$

- the canonical morphism

$$dX \rightarrow TX$$

from the diagonal to the total simplicial set is a weak equivalence in $\mathbf{sSet}_{\text{Quillen}}$;

- the adjunction unit

$$X \rightarrow T\text{Dec}X$$

is a weak equivalence in $\mathbf{sSet}_{\text{Quillen}}$.

For every $X \in \mathbf{sSet}$

- there is a natural isomorphism $T\text{const}X \simeq X$.

This is due to [CeRe05][St11].

Corollary 2.3.27. *For*

$$F : \Delta^{\text{op}} \rightarrow [C^{\text{op}}, \text{sSet}_{\text{Quillen}}]_{\text{inj,loc}}$$

a simplicial object in simplicial presheaves, its homotopy colimit is given by applying objectwise over each $U \in C$ the total simplicial set functor

$$\mathbb{L} \lim_{\rightarrow} F \simeq (U \mapsto TF(U)).$$

Proof. By prop. 2.3.26 this follows from prop. 2.3.22. \square

Remark 2.3.28. The use of the total simplicial set instead of the diagonal simplicial set in the presentation of simplicial homotopy colimits is useful and reduces to various traditional notions in particular in the context of group objects and action groupoid objects. This we discuss below in 3.6.8.2 and 3.6.10.3.

2.3.2.5 Effective epimorphisms, atlases and décalage We discuss aspects of the presentation of effective epimorphisms, def. 2.3.3, with respect to presentations of the ambient ∞ -topos by categories of simplicial presheaves, 2.2.3.

Observation 2.3.29. If the ∞ -topos \mathbf{H} is presented by a category of simplicial presheaves, 2.2.3, then for X a simplicial presheaf the canonical morphism of simplicial presheaves $\text{const}X_0 \rightarrow X$ that includes the presheaf of 0-cells as a simplicially constant simplicial presheaf presents an effective epimorphism in \mathbf{H} .

Proof. By prop. 2.3.6. \square

Remark 2.3.30. In practice the presentation of an ∞ -stack by a simplicial presheaf is often taken to be understood, and then observation 2.3.29 induces also a canonical atlas.

We now discuss a fibration resolution of the canonical atlas. Let $\sigma : \Delta \times \Delta \rightarrow \Delta$ the functor from def. 2.3.23, defining *total décalage*.

Definition 2.3.31. Write

$$\text{Dec}_0 : \text{sSet} \rightarrow \text{sSet}$$

for the functor given by precomposition with $\sigma(-, [0]) : \Delta \rightarrow \Delta$, and

$$\text{Dec}^0 : \text{sSet} \rightarrow \text{sSet}$$

for the functor given by precomposition with $\sigma([0], -) : \Delta \rightarrow \Delta$. This is called the plain *décalage functor* or *shifting functor*.

This functor was introduced in [Il72]. A discussion in the present context is in section 2.2 of [St11].

Proposition 2.3.32. *The décalage of X is isomorphic to the simplicial set*

$$\text{Dec}_0 X = \text{Hom}(\Delta^\bullet \star \Delta[0], X),$$

where $(-) \star (-) : \text{sSet} \times \text{sSet} \rightarrow \text{sSet}$ is the join of simplicial sets. The canonical inclusions $\Delta[n], \Delta[0] \rightarrow \Delta[n] \star \Delta[0]$ induce two canonical morphisms

$$\begin{array}{ccc} \text{Dec}_0 X & \longrightarrow & X \\ \downarrow \simeq & & \\ \text{const}X_0 & & \end{array}$$

where

- the horizontal morphism is given in degree n by $d_{n+1} : X_{n+1} \rightarrow X_n$;
- the horizontal morphism is a Kan fibration;
- the vertical morphism is a weak homotopy equivalence;
- a weak homotopy inverse is given by the morphism that is degreewise given by the degeneracy morphisms in X .

Proof. The relation to the join of simplicial sets is nicely discussed around page 7 of [RoSt12]. The weak homotopy equivalence is classical, see for instance [St11].

To see that $\text{Dec}_0 X \rightarrow X$ is a Kan fibration, notice that for all $n \in \mathbb{N}$ we have $(\text{Dec}_0 X)_n = \text{Hom}(\Delta[c] \star \Delta[0], X)$, where $(-) \star (-) : \text{sSet} \times \text{sSet} \rightarrow \text{sSet}$ is the join of simplicial sets. Therefore the lifting problem

$$\begin{array}{ccc} \Lambda^i[n] & \longrightarrow & \text{Dec}_0 X \\ \downarrow & & \downarrow \\ \Delta[n] & \longrightarrow & X \end{array}$$

is equivalently the lifting problem

$$\begin{array}{ccc} (\Lambda^i[n] \star \Delta[n]) \amalg_{\Lambda^i[n]} \Delta[n] & \longrightarrow & X \\ \downarrow & & \downarrow \\ \Delta[n] \star \Delta[0] & \longrightarrow & * \end{array} .$$

Here the left morphism is anodyne morphism, in fact is an $(n+1)$ -horn inclusion. Hence a lift exists if X is a Kan complex. (Alternatively, notice that $\text{Dec}_0 X$ is the disjoint union of slices $X_{/x}$ for $x \in X_0$. By cor. 2.1.2.2 in [L-Topos] the projection $X_{/x} \rightarrow X$ is a left fibration if X is Kan fibrant, and by prop. 2.1.3.3 there this implies that it is a Kan fibration). \square

Corollary 2.3.33. *For X in $[C^{\text{op}}, \text{sSet}]_{\text{proj}}$ fibrant, a fibration resolution of the canonical effective epimorphism $\text{const} X_0 \rightarrow X$ from observation 2.3.29 is given by the décalage morphism $\text{Dec}_0 X \rightarrow X$, def. 2.3.31.*

Proof. It only remains to observe that we have a commuting diagram

$$\begin{array}{ccc} \text{const} X_0 & \xrightarrow{s} & \text{Dec}_0 X \\ \downarrow & & \downarrow \\ X & \xrightarrow{=} & X \end{array} ,$$

where the top morphism, given degreewise by the degeneracy maps in X , is a weak homotopy equivalence by classical results. \square

3 Cohesive and differential homotopy type theory

We discuss here the general abstract theory of *cohesive* ∞ -toposes and of *differential cohesive* ∞ -toposes and of the homotopical, cohomological, geometrical and differential structures internal to them.

Below in 4 we construct models of these axioms.

3.1 Introduction and survey

A topos or ∞ -topos may be viewed both as a category or, respectively, ∞ -category of generalized spaces – then also called a “*gros topos*” – or as a generalized space itself – then also called a “*petit topos*”. The duality relation between these two perspectives is given by prop. 3.6.14, which says that every ∞ -topos regarded as a generalized space is equivalent to the ∞ -category of generalized étale spaces *over* it, while, conversely, every collection of generalized spaces encoded by an ∞ -topos may be understood as being those generalized spaces equipped with local equivalences to a fixed generalized model space.

From this description it is intuitively clear that the “smaller” an ∞ -topos is when regarded as a generalized space, the “larger” is the collection of generalized spaces locally modeled on it, and vice versa. If by “size” we mean “dimension”, there are two notions of *dimension of an ∞ -topos* \mathbf{H} that coincide with the ordinary notion of dimension of a manifold X when $\mathbf{H} = \text{Sh}_\infty(X)$, but which may be different in general. These are

- homotopy dimension (see def. 3.6.71 below);
- cohomology dimension ([L-Topos], section 7.2.2).

If by “size” we mean “nontriviality of homotopy groups”, hence nontriviality of *shape* of a space, there is the notion of

- shape of an ∞ -topos ([L-Topos], section 7.1.6);

which coincides with the topological shape of X in the case that $\mathbf{H} = \text{Sh}_\infty(X)$, as above. Finally, if by “small size” we just mean *finite dimensional*, then the property of ∞ -toposes reflecting that is

- hypercompleteness ([L-Topos], section 6.5.2).

For the description of higher geometry and higher differential geometry, we are interested in ∞ -toposes that are “maximally *gros*” and “minimally *petit*”: regarded as generalized spaces they should look like *fat points* or *contractible blobs* being the abstract blob of *geometry* that every object in them is supposed to be locally modeled on, but that otherwise do not make these objects be parameterized over a nontrivial space.

The following notions of *local ∞ -topos*, *∞ -connected ∞ -topos*, *cohesive ∞ -topos*, and *differential cohesive ∞ -topos* describe extra properties of the global section geometric morphism of an ∞ -topos that imply that some or all of the measures of “size” of the ∞ -topos vanish, hence that make the ∞ -topos be far from being a non-trivial generalized space itself, and instead be genuinely a collection of generalized spaces modeled on some notion of local geometry.

All these properties are equivalently encoded in terms of *idempotent ∞ -(co)monads* on the ∞ -topos \mathbf{H}

$$\square, \diamond : \mathbf{H} \rightarrow \mathbf{H}.$$

Internally, on the homotopy type theory language of \mathbf{H} , these are (higher) *closure operators* or *modalities* on the type system (more on this is below in 3.4.1.2). Externally, these structures correspond to adjunctions

$$(L \dashv R) : \mathbf{H} \begin{array}{c} \xleftarrow{L} \\ \xrightarrow{R} \end{array} \mathbf{B}$$

such that L or R is a fully faithful ∞ -functor, by $\square \simeq L \circ R$ and $\diamond \simeq R \circ L$, or the other way around.

Proposition 3.1.1. *Let $(L \dashv R) : \mathcal{C} \begin{array}{c} \xleftarrow{L} \\ \xrightarrow{R} \end{array} \mathcal{D}$ be a pair of adjoint ∞ -functors. Then*

1. The left adjoint ∞ -functor L is fully faithful precisely if the adjunction unit is an equivalence $\text{id}_{\mathcal{D}} \xrightarrow{\cong} R \circ L$.
2. The right adjoint ∞ -functor R is fully faithful precisely if the adjunction counit is an equivalence $L \circ R \xrightarrow{\cong} \text{id}_{\mathcal{C}}$.

Proof. This is [L-Topos], p. 308 or follows directly from it. □

For encoding “gros” geometry in the above sense, here the comonadic \square is itself to be part of an adjunction with the monadic \diamond , as $\square \dashv \diamond$ or $\diamond \dashv \square$. Such a situation corresponds externally to adjoint triples of ∞ -functors

$$(f_! \dashv f^* \dashv f_*) : \mathbf{H} \begin{array}{c} \xrightarrow{f_!} \\ \xleftarrow{f^*} \\ \xrightarrow{f_*} \end{array} \mathbf{B} \quad \text{or} \quad (f^* \dashv f_* \dashv f^!) : \mathbf{H} \begin{array}{c} \xleftarrow{f^*} \\ \xrightarrow{f_*} \\ \xleftarrow{f^!} \end{array} \mathbf{B}$$

such that the middle functor or the two outer functors are fully faithful:

$$(\diamond \dashv \square) \simeq (f^* f_! \dashv f^* f_*) \quad \text{or} \quad (\square \dashv \diamond) \simeq (f^* f_* \dashv f^! f_*).$$

All that matters for the nature of the induced modalities is in which direction these functors go and which of them are fully faithful. Moreover, both direction and fully faithfulness are necessarily alternating through the adjoint triple, so what really matters is only which functor we regard as the direct image, the number of adjoints it has to the left and to the right, and whether it is itself fully faithful or its adjoints are. To bring that basic information out more clearly it may be helpful to introduce the following condensed notation.

Let $\dots\dots\dots \overline{\hspace{1cm}} \dots\dots\dots$ stand for an adjoint pair where the direct image f_* points from \mathbf{H} to \mathbf{B} , (this is the bar on the dotted baseline) and such that it has a single left adjoint f^* (the second bar on top).

Accordingly, if there is a further left adjoint $f_!$ then we draw a further bar on top $\dots\dots\dots \overline{\overline{\hspace{1cm}}} \dots\dots\dots$. If there is a further right adjoint $f^!$ then we draw a further bar on the bottom $\dots\dots\dots \overline{\hspace{1cm}} \overline{\hspace{1cm}} \dots\dots\dots$. And so forth: bars on top are left adjoint to bars below them, and the direction is left-to-right for the bar on the base line and for every second bar next to it, while it is right-to-left for every other bar. Finally, we mark the fully faithful functors by breaking the corresponding bar. For instance the notation $\dots\dots\dots \overline{\overline{\hspace{1cm}}} \dots\dots\dots$

means that the inverse image is fully faithful, hence is shorthand for an adjunction of the form $\mathbf{H} \begin{array}{c} \xleftarrow{f^*} \\ \xrightarrow{f_*} \end{array} \mathbf{B}$, and so forth.

The following table lists, in the above notation, the possibilities for adjoint higher modalities together with the name of the corresponding attribute of \mathbf{H} as an ∞ -topos over the base \mathbf{B} .

Locality ($b \dashv \sharp$) (section 3.2).

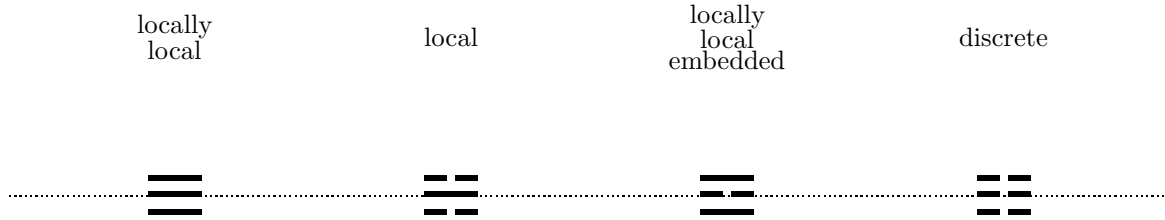

∞ -Connectedness ($\mathbf{\Pi} \dashv b$) (section 3.3).

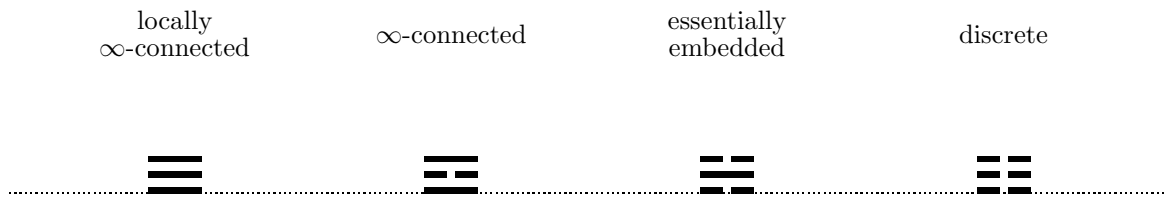

Cohesion ($\mathbf{\Pi} \dashv b \dashv \sharp$) (section 3.4).



Differential cohesion ($\mathbf{Red} \dashv \mathbf{\Pi}_{\text{inf}} \dashv b_{\text{inf}}$) (section 3.5).

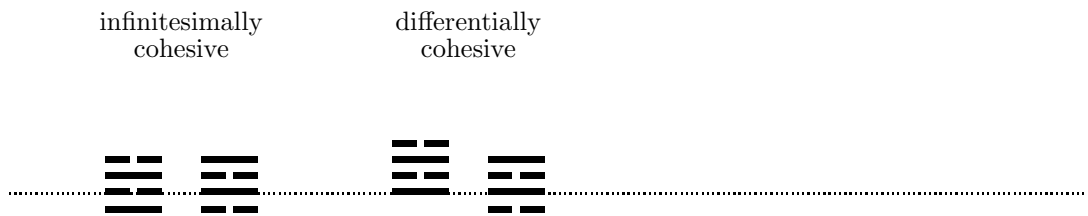

We discuss a list of structures that may be formulated internal to such \mathbf{H} :

- 3.6 – Structures in an ∞ -topos;
- 3.7 – Structures in a local ∞ -topos;
- 3.8 – Structures in an ∞ -connected ∞ -topos;
- 3.9 – Structures in a cohesive ∞ -topos;
- 3.10 – Structures in a differential ∞ -topos.

3.2 Local ∞ -toposes

The following definition is the direct generalization of the notion of *local topos* [JohMo89].

Definition 3.2.1. An ∞ -topos \mathbf{H} is called *locally local* if the global section geometric morphism has a right adjoint.

$$\mathbf{H} \begin{array}{c} \xleftarrow{\text{Disc}} \\ \xleftarrow{\Gamma} \xrightarrow{\Gamma} \\ \xleftarrow{\text{coDisc}} \end{array} \infty\text{Grpd} .$$

It is called *local* if that right adjoint is in addition fully faithful.

Proposition 3.2.2. *A local ∞ -topos*

1. *has homotopy dimension 0 (see def. 3.6.71 below);*
2. *has cohomological dimension 0 ([L-Topos], section 7.2.2);*
3. *is hypercomplete.*

Proof. The first statement is cor. 3.6.77 below. The second is a consequence of the first by [L-Topos], cor. 7.2.2.30. The third follows from the second by [L-Topos], cor. 7.2.1.12. \square

3.3 Locally ∞ -connected ∞ -toposes

We discuss ∞ -toposes satisfying a higher geometric connectedness condition.

3.3.1 General abstract

The following definition is the direct generalization standard notion of a *locally/globally connected topos* [Joh02]: a topos whose terminal geometric morphism has an extra left adjoint that computes geometric connected components, hence a geometric notion of π_0 . We will see in 3.8, that as we pass to ∞ -toposes, the extra left adjoint provides a good definition of all geometric homotopy groups.

Definition 3.3.1. An ∞ -topos \mathbf{H} we call *locally ∞ -connected* if the (essentially unique) global section ∞ -geometric morphism from prop. 2.2.4 is an *essential ∞ -geometric morphism* in that it has a further left adjoint Π :

$$(\Pi \dashv \Delta \dashv \Gamma) : \mathbf{H} \begin{array}{c} \xrightarrow{\Pi} \\ \xleftarrow{\Delta} \xrightarrow{\Gamma} \\ \xrightarrow{\Gamma} \end{array} \infty\text{Grpd} .$$

If in addition Δ is fully faithful, then we say that \mathbf{H} is in addition an *∞ -connected* or *globally ∞ -connected* ∞ -topos.

Remark 3.3.2. Meanwhile, a locally ∞ -connected ∞ -topos as above has been called an ∞ -topos of *constant shape* in [L-Alg], section A.1. Some of the following statements now overlap with the discussion there.

Proposition 3.3.3. *For \mathbf{H} a locally/globally ∞ -connected ∞ -topos, the underlying 1-topos $\tau_{\leq 0}\mathbf{H}$ of 0-truncated objects (def. 3.6.22) is a locally/globally connected topos (as in [Joh02] C1.5, C3.3).*

Proof. By prop. 2.2.5 and by the very definition of truncated objects Γ takes 0-truncated objects in \mathbf{H} to 0-truncated objects in ∞Grpd , hence the restriction $\Gamma|_{\tau_{\leq 0}}$ factors through the inclusion $\text{Set} \simeq \tau_{\leq 0}\infty\text{Grpd} \hookrightarrow \infty\text{Grpd}$.

Similarly the restriction $\Delta|_{\leq 0}$ factors through the inclusion $\tau_{\leq 0}\mathbf{H} \hookrightarrow \mathbf{H}$: by definition this is the case if for all $S \in \text{Set}$ and all $X \in \mathbf{H}$ the hom- ∞ -groupoid $\mathbf{H}(X, \Delta S) \in \infty\text{Grpd}$ is equivalently a set. But by the defining right-adjointness of Δ this is equivalently

$$\mathbf{H}(X, \Delta S) \simeq \infty\text{Grpd}(\Pi(X), S) \simeq \text{Set}(\tau_{\leq 0}\Pi(X), S) \in \text{Set} \hookrightarrow \infty\text{Grpd} ,$$

which is a set by assumption that S is 0-truncated.

By uniqueness of adjoints and the fact that $\tau_{\leq 0} : \infty\text{Grpd} \rightarrow \text{Set}$ is left adjoint to the inclusion, this means that $\Delta|_{\leq 0} : \text{Set}^{\text{C}} \longrightarrow \infty\text{Grpd} \xrightarrow{\Delta} \mathbf{H}$ has a left adjoint

$$\Pi_0 := \tau_{\leq} \circ \Pi.$$

Finally $\tau_{\leq 0}$ preserves finite products by [L-Topos], lemma 6.5.1.2. and if Π preserves the terminal object then so does Π_0 . \square

Proposition 3.3.4. *A locally ∞ -connected topos $(\Pi \dashv \Delta \dashv \Gamma) : \mathbf{H} \rightarrow \infty\text{Grpd}$ is globally ∞ -connected precisely if the following equivalent conditions hold.*

1. *The inverse image Δ is a fully faithful ∞ -functor.*
2. *The extra left adjoint Π preserves the terminal object.*

Proof. This follows verbatim the proof for the familiar statement about connected toposes, since all the required properties have ∞ -analogs: we have that

- Δ is fully faithful precisely if the $(\Pi \dashv \Delta)$ -adjunction unit is an equivalence, by prop. 3.1.1.
- every ∞ -groupoid S is the ∞ -colimit over itself of the ∞ -functor constant on the point, by prop. 2.3.1:

$$S \simeq \lim_{\rightarrow_S} *$$

Therefore if Δ is fully faithful, then

$$\begin{aligned} \Pi(*) &\simeq \Pi\Delta(*) \\ &\simeq * \end{aligned}$$

and hence Π preserves the terminal object. Conversely, if Π preserves the terminal object then for any $S \in \infty\text{Grpd}$ we have that

$$\begin{aligned} \Pi\Delta S &\simeq \Pi\Delta \lim_{\rightarrow_S} * \\ &\simeq \lim_{\rightarrow_S} \Pi\Delta * \\ &\simeq \lim_{\rightarrow_S} * \\ &\simeq S \end{aligned}$$

and hence Δ is fully faithful. \square

Proposition 3.3.5. *A locally ∞ -connected ∞ -topos*

1. *has the shape of $\Pi(*)$;*
2. *hence has the shape of the point if it is globally ∞ -connected.*

Proof. By inspection of the definitions. \square

3.3.2 Presentations

We discuss presentations of locally and globally ∞ -connected ∞ -toposes, def. 3.3.1, by categories of simplicial presheaves over a suitable site of definition.

Definition 3.3.6. We call a site (a small category equipped with a coverage) *locally and globally ∞ -connected* if

1. it has a terminal object $*$;
2. for every generating covering family $\{U_i \rightarrow U\}$ in C
 - (a) $\{U_i \rightarrow U\}$ is a *good covering*, def. 2.2.22: the Čech nerve $C(\{U_i\}) \in [C^{\text{op}}, \text{sSet}]$ is degreewise a coproduct of representables;
 - (b) the colimit $\varinjlim : [C^{\text{op}}, \text{sSet}] \rightarrow \text{sSet}$ of $C(\{U_i\})$ is weakly contractible

$$\varinjlim C(\{U_i\}) \xrightarrow{\simeq} *$$

Proposition 3.3.7. *For C a locally and globally ∞ -connected site, the ∞ -topos $Sh_{\infty}(C)$ is locally and globally ∞ -connected.*

We prove this after noting two lemmas.

Lemma 3.3.8. *For $\{U_i \rightarrow U\}$ a covering family in the ∞ -connected site C , the Čech nerve $C(\{U_i\}) \in [C^{\text{op}}, \text{sSet}]$ is a cofibrant resolution of U both in the global projective model structure $[C^{\text{op}}, \text{sSet}]_{\text{proj}}$ as well as in the local model structure $[C^{\text{op}}, \text{sSet}]_{\text{proj,loc}}$.*

Proof. By assumption on C we have that $C(\{U_i\})$ is a split hypercover [DHS04]. This implies that $C(\{U_i\})$ is cofibrant in the global model structure. By general properties of left Bousfield localization we have that the cofibrations in the local model structure are the same as in the global one. Finally that $C(\{U_i\}) \rightarrow U$ is a weak equivalence in the local model structure holds effectively by definition (since we are localizing at these morphisms). \square

Proposition 3.3.9. *On a locally and globally ∞ -connected site C , the global section ∞ -geometric morphism $(\Delta \dashv \Gamma) : Sh_{\infty}(C) \rightarrow \infty\text{Grpd}$ is presented under prop. 2.1.39 by the simplicial Quillen adjunction*

$$(\text{Const} \dashv \Gamma) : [C^{\text{op}}, \text{sSet}]_{\text{proj,loc}} \xrightleftharpoons[\Gamma]{\text{Const}} \text{sSet}_{\text{Quillen}} ,$$

where Γ is the functor that evaluates on the terminal object, $\Gamma(X) = X(*)$, and where Const is the functor that assigns constant presheaves $\text{Const} S : U \mapsto S$.

Proof. That we have a 1-categorical adjunction $(\text{Const} \dashv \Gamma)$ follows by noticing that since C has a terminal object we have that $\Gamma = \varprojlim$ is given by the limit operation.

To see that we have a Quillen adjunction first notice that we have a Quillen adjunction on the global model structure

$$(\text{Const} \dashv \Gamma) : [C^{\text{op}}, \text{sSet}]_{\text{proj}} \xrightleftharpoons[\Gamma]{\text{Const}} \text{sSet}_{\text{Quillen}} ,$$

since Γ manifestly preserves fibrations and acyclic fibrations there. Because $[C^{\text{op}}, \text{sSet}]_{\text{proj,loc}}$ is left proper and has the same cofibrations as the global model structure, it follows with prop. 2.1.40 that for this to descend to a Quillen adjunction on the local model structure it is sufficient that Γ preserves locally fibrant objects. But every fibrant object in the local structure is in particular fibrant in the global structure, hence in particular fibrant over the terminal object of C .

The left derived functor $\mathbb{L}\text{Const}$ of $\text{Const} : \text{sSet}_{\text{Quillen}} \rightarrow [C^{\text{op}}, \text{sSet}]$ preserves ∞ -limits (because ∞ -limits in an ∞ -category of ∞ -presheaves are computed objectwise), and moreover ∞ -stackification, being the left derived functor of $\text{Id} : [C^{\text{op}}, \text{sSet}]_{\text{proj}} \rightarrow [C^{\text{op}}, \text{sSet}]_{\text{proj}}$, is a left exact ∞ -functor, therefore the left derived functor of $\text{Const} : \text{sSet}_{\text{Quillen}} \rightarrow [C^{\text{op}}, \text{sSet}]_{\text{proj,loc}}$ preserves finite ∞ -limits.

This means that our Quillen adjunction does model an ∞ -geometric morphism $\text{Sh}_{\infty}(C) \rightarrow \infty\text{Grpd}$. By prop. 2.2.4 this is indeed a representative of the terminal geometric morphism as claimed. \square

Proof of theorem 3.3.7. By general abstract facts the sSet-functor $\text{Const} : \text{sSet} \rightarrow [C^{\text{op}}, \text{sSet}]$ given on $S \in \text{sSet}$ by $\text{Const}(S) : U \mapsto S$ for all $U \in C$ has an sSet-left adjoint

$$\Pi : X \mapsto \int^U X(U) = \varinjlim X$$

naturally in X and S , given by the colimit operation. Notice that since sSet is itself a category of presheaves (on the simplex category), these colimits are degreewise colimits in Set. Also notice that the colimit over a representable functor is the point (by a simple Yoneda lemma-style argument).

Regarded as a functor $\text{sSet}_{\text{Quillen}} \rightarrow [C^{\text{op}}, \text{sSet}]_{\text{proj}}$ the functor Const manifestly preserves fibrations and acyclic fibrations and hence

$$(\Pi \dashv \text{Const}) : [C^{\text{op}}, \text{sSet}]_{\text{proj}} \begin{array}{c} \xrightarrow{\text{Id}} \\ \xleftarrow{\text{Const}} \end{array} \text{sSet}_{\text{Quillen}}$$

is a Quillen adjunction, in particular $\Pi : [C^{\text{op}}, \text{sSet}]_{\text{proj}} \rightarrow \text{sSet}_{\text{Quillen}}$ preserves cofibrations. Since by general properties of left Bousfield localization the cofibrations of $[C^{\text{op}}, \text{sSet}]_{\text{proj,loc}}$ are the same, also $\Pi : [C^{\text{op}}, \text{sSet}]_{\text{proj,loc}} \rightarrow \text{sSet}_{\text{Quillen}}$ preserves cofibrations.

Since $\text{sSet}_{\text{Quillen}}$ is a left proper model category it follows with prop. 2.1.40 that for

$$(\Pi \dashv \text{Const}) : [C^{\text{op}}, \text{sSet}]_{\text{proj,loc}} \begin{array}{c} \xrightarrow{\text{Id}} \\ \xleftarrow{\text{Const}} \end{array} \text{sSet}_{\text{Quillen}}$$

to be a Quillen adjunction, it suffices now that Const preserves fibrant objects. This means that constant simplicial presheaves satisfy descent along covering families in the ∞ -cohesive site C : for every covering family $\{U_i \rightarrow U\}$ in C and every simplicial set S it must be true that

$$[C^{\text{op}}, \text{sSet}](U, \text{Const}S) \rightarrow [C^{\text{op}}, \text{sSet}](C(\{U_i\}), \text{Const}S)$$

is a homotopy equivalence of Kan complexes. (Here we use that U , being a representable, is cofibrant, that $C(\{U_i\})$ is cofibrant by the lemma 3.3.8 and that $\text{Const}S$ is fibrant in the projective structure by the assumption that S is fibrant. So the simplicial hom-complexes in the above equation really are the correct derived hom-spaces.)

But that this is the case follows by the condition on the ∞ -connected site C by which $\varinjlim C(\{U_i\}) \simeq *$: using this we have that

$$[C^{\text{op}}, \text{sSet}](C(\{U_i\}), \text{Const}S) = \text{sSet}(\varinjlim C(\{U_i\}), S) \simeq \text{sSet}(*, S) = S.$$

So we have established that $(\varinjlim \dashv \text{Const})$ is also a Quillen adjunction on the local model structure.

It is clear that the left derived functor of \varinjlim preserves the terminal object: since that is representable by assumption on C , it is cofibrant in $[C^{\text{op}}, \text{sSet}]_{\text{proj,loc}}$, hence $\mathbb{L}\varinjlim * \simeq \varinjlim * = *$. \square

3.4 Cohesive ∞ -toposes

We now combine the notions of local ∞ -toposes and ∞ -connected ∞ -toposes to that of cohesive ∞ -toposes

3.4.1 General abstract

We give the definition and basic properties of cohesive ∞ -toposes first externally, in 3.4.1.1 in terms of properties of the global section geometric morphism, and then internally, in the language of the internal type theory of an ∞ -topos, in 3.4.1.2.

3.4.1.1 External formulation The following definition is the direct generalization of the main axioms in the definition of *topos of cohesion* from [Law07].

Definition 3.4.1. A *cohesive ∞ -topos* \mathbf{H} is

1. a locally and globally ∞ -connected topos \mathbf{H} , def 3.3.1,
2. which in addition is a *local ∞ -topos*, def. 3.2.1;
3. and such that the extra left adjoint preserves not just the terminal object, but all finite products.

Remark 3.4.2. The two conditions say in summary that an ∞ -topos is cohesive precisely if it admits quadruple of adjoint ∞ -functors

$$(\Pi \dashv \Delta \dashv \Gamma \dashv \nabla) : \mathbf{H} \begin{array}{c} \xleftarrow{\quad \Pi \quad} \\ \xrightarrow{\quad \Delta \quad} \\ \xleftarrow{\quad \Gamma \quad} \\ \xrightarrow{\quad \nabla \quad} \end{array} \infty\text{Grpd}$$

such that Π preserves finite products.

We may think of these axioms as encoding properties that characterize those ∞ -toposes of ∞ -groupoids that are equipped with extra *cohesive structure*. In order to reflect this geometric interpretation notationally we will from now on write

$$(\Pi \dashv \text{Disc} \dashv \Gamma \dashv \text{coDisc}) : \mathbf{H} \begin{array}{c} \xleftarrow{\quad \Pi \quad} \\ \xrightarrow{\quad \text{Disc} \quad} \\ \xleftarrow{\quad \Gamma \quad} \\ \xrightarrow{\quad \text{coDisc} \quad} \end{array} \infty\text{Grpd}$$

for the defining ∞ -connected and ∞ -local geometric morphism and say for $S \in \infty\text{Grpd}$ that

- $\text{Disc}S \in \mathbf{H}$ is a *discrete object* of \mathbf{H} or a *discrete cohesive ∞ -groupoid* obtained by equipping S with *discrete cohesive structure*;
- $\text{coDisc}S \in \mathbf{H}$ is a *codiscrete object* of \mathbf{H} or a *codiscrete cohesive ∞ -groupoid*, obtained by equipping S with *indiscrete cohesive structure*;

and for $X \in \mathbf{H}$ that

- $\Gamma(X) \in \infty\text{Grpd}$ is the *underlying ∞ -groupoid* of X ;
- $\Pi(X)$ is the *fundamental ∞ -groupoid* or *geometric path ∞ -groupoid* of X .

A simple but instructive toy example illustrating these interpretations is given by the *Sierpinski ∞ -topos*, discussed below in example 4.1.2. A detailed discussion of these geometric interpretations in various models is in 4. For emphasis we summarize the following list of properties of a cohesive ∞ -topos \mathbf{H} that show that regarded as a generalized space itself, \mathbf{H} looks like one fat point, to be thought of as the archetypical cohesive blob.

Proposition 3.4.3. A *cohesive ∞ -topos*

1. has homotopy dimension 0;

2. has cohomological dimension 0;
3. has the shape of the point;
4. is hypercomplete.

Proof. By prop. 3.2.2 and prop. 3.3.5. □

Every adjoint quadruple of functors induces an adjoint triple of endofunctors:

Definition 3.4.4. On any cohesive ∞ -topos \mathbf{H} define the adjoint triple of functors

$$(\mathbf{\Pi} \dashv \flat \dashv \sharp) : \mathbf{H} \begin{array}{c} \xrightarrow{\times} \\ \xleftarrow{\text{Disc}} \\ \xrightarrow{\Gamma} \end{array} \infty\text{Grpd} \begin{array}{c} \xrightarrow{\text{Disc}} \\ \xleftarrow{\Gamma} \\ \xrightarrow{\text{coDisc}} \end{array} \mathbf{H} .$$

Remark 3.4.5. The geometric interpretation of these three functors is discussed below in 3.8.3, 3.8.5 and 3.7.2, respectively:

- $\mathbf{\Pi}$ is the *shape modality*, the *geometric path* or *geometric homotopy* functor or *fundamental* ∞ -*groupoid* functor;
- \flat is the *flat modality*, for $A \in \mathbf{H}$ we may pronounce $\flat A$ as “flat A ”, it is the coefficient object for *flat cohomology* with coefficients in A ;
- \sharp is the *sharp modality*, for $A \in \mathbf{H}$ we may pronounce $\sharp A$ as “sharp A ”, it is the classifying object for “sharply varying” A -principal ∞ -bundles, those that need not be geometric (not continuous).

Every adjoint triple $(\mathbf{\Pi} \dashv \text{Disc} \dashv \Gamma)$ induces a canonical transformation:

Definition 3.4.6. For \mathbf{H} a cohesive ∞ -topos with modalities $(\mathbf{\Pi} \dashv \flat \dashv \sharp)$, we say that the composite transformation

$$(\flat X \longrightarrow \mathbf{\Pi} X) := (\flat X \longrightarrow X \longrightarrow \mathbf{\Pi} X)$$

of the $(\text{Disc} \dashv \Gamma)$ -counit followed by the $(\mathbf{\Pi} \dashv \text{Disc})$ -unit, natural in $X \in \mathbf{H}$, is the *pieces-to-points transform*.

Given the geometric interpretation of $\mathbf{\Pi}$ and \flat , this map may be thought of as sending each point of a cohesive space X to the *cohesive piece* that it sits in. This is a central conceptual insight in [Law07].

Proposition 3.4.7. *There is a natural equivalence of natural transformations*

$$(\flat A \longrightarrow \mathbf{\Pi} X) \simeq \text{Disc}(\Gamma X \longrightarrow \mathbf{\Pi} X) ,$$

where

$$(\Gamma X \longrightarrow \mathbf{\Pi} X) := \left(\Gamma X \longrightarrow \Gamma \text{Disc} \mathbf{\Pi} X \xrightarrow{\simeq} \mathbf{\Pi} X \right)$$

and where on the right we have the composite of the image under Γ of the $(\mathbf{\Pi} \dashv \text{Disc})$ -unit followed by the $(\text{Disc} \dashv \Gamma)$ -counit applied to $\mathbf{\Pi} X$. In particular the *points-to-pieces transform* $\flat \rightarrow \mathbf{\Pi}$ is an equivalence on $X \in \mathbf{H}$ precisely if $\Gamma \rightarrow \mathbf{\Pi}$ is.

Proof. By the formula for ∞ -adjuncts and the fully faithfulness of Disc . □

Definition 3.4.8. Given an object $X \in \mathbf{H}$ of a cohesive ∞ -topos over ∞Grpd , we say that

1. *pieces have points* in X if the points-to-pieces transform is an effective epimorphism, def. 2.3.3, $\mathfrak{b}X \twoheadrightarrow \mathbf{II}X$;
2. X has *one point per piece* the points-to-pieces transform is an equivalence, $\mathfrak{b}X \xrightarrow{\simeq} \mathbf{II}X$.

Example 3.4.9. For the class of cohesive ∞ -toposes constructed below in 3.4.2 from ∞ -cohesive sites, it is true for all their objects that *pieces have points*. A class of (relative) cohesive ∞ -toposes for which this is not the case is discussed in 4.1.1.

Example 3.4.10. The property *one point per piece* is a characteristic feature of *infinitesimally thickened points* (often called “formal points”) and indeed we find examples of this below in in Goodwillie-tangent cohesion, 4.1, in synthetic differential cohesion, 4.5, and in supergeometric cohesion, 4.6.

Remark 3.4.11. The pieces-to-points transformation appears as part of the canonical *stable differential cohomology diagram* (prop. 4.1.17 below) which exists for every object in Goodwillie-tangent cohesive ∞ -toposes (def. 4.1.8 below).

Therefore it is useful to introduce the following terminology.⁹

Definition 3.4.12. A cohesive ∞ -topos \mathbf{H} for which the points-to-pieces transform, def. 3.4.6, is an equivalence

$$\mathfrak{b} \xrightarrow{\simeq} \mathbf{II}$$

we call an *infinitesimal cohesive ∞ -topos*.

Infinitesimal cohesive ∞ -toposes are typically simple in themselves, but in examples they are relevant as alternative base ∞ -toposes over which richer ∞ -toposes are cohesive. We will appeal repeatedly to the following elementary fact.

Proposition 3.4.13. *If \mathcal{C} is a small ∞ -category with a zero-object (an object which is both initial as well as terminal), then the ∞ -presheaf ∞ -category $\mathbf{PSh}_\infty(\mathcal{C})$, def. 2.1.15, is infinitesimally cohesive, def. 3.5.*

Proof. The constant ∞ -presheaf ∞ -functor $\mathbf{Disc} : \infty\mathbf{Grpd} \rightarrow \mathbf{PSh}_\infty(\mathbf{Grpd})$ has a left adjoint \mathbf{II} and a right adjoint \mathbf{I} , given by forming ∞ -limits and ∞ -colimits of ∞ -functors on \mathcal{C} , respectively. Due to the assumption of a zero object $*$, both of these are given by evaluation on that zero object. This first of all implies that $\mathbf{I}\mathbf{Disc} \simeq \text{id}$, hence that \mathbf{I} is full and faithful, and that \mathbf{II} preserves all ∞ -limits, hence finite ∞ -products, so that $\mathbf{PSh}_\infty(\mathcal{C})$ is indeed cohesive. Second it implies that the unit $\text{id} \rightarrow \mathbf{Disc}\mathbf{II}$ is given on generators in $\mathcal{C} \hookrightarrow \mathbf{PSh}_\infty(\mathcal{C})$ by sending each of them to the zero object, and hence that $\mathbf{I} \rightarrow \mathbf{I}\mathbf{Disc}\mathbf{II}$ is an equivalence. By prop. 3.4.7 this implies the claim. \square

Remark 3.4.14. Below in 3.5.1 we re-encounter infinitesimal cohesion in the more general context of *differential cohesion*.

3.4.1.2 Internal formulation The above discussion in 3.4.1.1 looks at an ∞ -topos “from the outside”, namely as an object of the ∞ -category of all ∞ -toposes, and characterizes its cohesion in terms of additional properties of functors defined *on* it. But in 2.1.1 we saw that an ∞ -topos also comes with its *internal homotopy type theory* [UFP13], which describes it “from inside”. Mike Shulman has shown how one may formulate the axioms of cohesion in this internal homotopy type theory, to obtain *cohesive homotopy type theory*. An exposition of this is in [ScSh12], where pointers to the full details are given.

The crucial insight of Mike Shulman [Shu11] is that to implement cohesion fully formally in homotopy type theory one is to regard the sharp modality \sharp , remark 3.4.5, as the fundamental axiom that serves to

⁹ I am grateful to Mike Shulman for discussion of this notion. In def. 1 of [Law07] essentially this notion is referred to as a “quality type”.

exhibit the external base ∞ -topos as an internal sub-system of homotopy types. Then the flat modality and the shape modality are axiomatized based on the existence of the sharp modality.

While traditional topos theory (hence: 1-topos theory) had had an emphasis on the internal logic provided by toposes from the very beginning [Law65], the formulation of constructions in higher topos theory in general and of cohesive higher topos theory in particular in terms of the internal language of homotopy type theory has only just begun to be explored. But it is clear that it can provide considerable advantages. For instance the whole theory of relative Postnikov-Whitehead towers in ∞ -toposes (see 3.6.3 below), which in [L-Topos] takes a fairly lengthy list of lemmas to establish, follows elegantly with a few simple proofs from homotopy type theory, see chapter 7 of [UFP13] (some of this goes back to [SpRi12]). Combined with the richness of the formal consequences of the axioms of cohesion, for instance in the derivation of the long fiber sequences in stable differential cohomology in 4.1.2 below, this opens interesting perspectives.

In the following we briefly sketch how one begins going about re-formulating the axioms of cohesion in terms of structure internal to the ambient ∞ -topos. For more details we refer the reader to [ScSh12] and the pointers given there.

Theorem 3.4.15. *Let \mathbf{H} be an ∞ -topos. The inclusion of a full sub- ∞ -category*

$$\text{Disc} : \mathbf{B}_{\text{disc}} \hookrightarrow \mathbf{H}$$

– to be called the discrete objects – and of a full sub- ∞ -category

$$\text{coDisc} : \mathbf{B}_{\text{cod}} \hookrightarrow \mathbf{H}$$

– to be called the codiscrete objects – satisfies $\mathbf{B}_{\text{disc}} \simeq \mathbf{B}_{\text{cod}}$ and extends to an adjoint quadruple of the form

$$\begin{array}{ccc} \times & \xrightarrow{\Pi} & \text{---} \\ \mathbf{H} & \xleftarrow{\text{Disc}} & \mathbf{B} \\ & \xrightarrow{\Gamma} & \text{---} \\ & \xleftarrow{\text{coDisc}} & \text{---} \end{array}$$

as in def. 3.4.1 precisely if for every object $X \in \mathbf{H}$

1. there exists, with notation from def. 3.4.4,
 - (a) a morphism $X \rightarrow \Pi X$ to a discrete object;
 - (b) a morphism $\flat X \rightarrow X$ from a discrete object;
 - (c) a morphism $X \rightarrow \sharp X$ to codiscrete object;
2. such that for all discrete Y and codiscrete \tilde{Y} the induced morphisms
 - (a) $\mathbf{H}(\Pi X, Y) \rightarrow \mathbf{H}(X, Y)$;
 - (b) $\mathbf{H}(Y, \flat X) \rightarrow \mathbf{H}(Y, X)$;
 - (c) $\mathbf{H}(\sharp X, \tilde{Y}) \rightarrow \mathbf{H}(X, \tilde{Y})$;
 - (d) $\sharp(\flat X \rightarrow X)$;
 - (e) $\flat(X \rightarrow \sharp X)$

are equivalences.

Finally, Π preserves the terminal object if the morphism $* \rightarrow \Pi*$ is an equivalence.

Proof. Prop. 5.2.7.8 in [L-Topos] asserts that a full sub- ∞ -category $\mathbf{B} \hookrightarrow \mathbf{H}$ is reflectively embedded precisely if for every object $X \in \mathbf{H}$ there is a morphism

$$\text{loc}_X : X \rightarrow \mathbf{L}X$$

to an object $\mathbf{L}X \in \mathbf{H} \hookrightarrow \mathbf{H}$ such that for all $Y \in \mathbf{B} \hookrightarrow \mathbf{H}$ the morphism

$$\mathbf{H}(\text{loc}_X, Y) : \mathbf{H}(\mathbf{L}X, Y) \rightarrow \mathbf{H}(X, Y)$$

is an equivalence. In this case \mathbf{L} is the composite of the embedding and its left adjoint. Accordingly, a dual statement holds for coreflective embeddings. This gives the structure and the first three properties of the above assertion. We identify therefore

$$(\mathbf{\Pi} \dashv \flat \dashv \sharp) := (\text{Disc } \mathbf{\Pi} \dashv \text{Disc } \Gamma \dashv \text{coDisc } \Gamma).$$

It remains to show that the last two properties say precisely that the sub- ∞ -categories of discrete and codiscrete objects are equivalent and that under this equivalence their coreflective and reflective embedding, respectively, fits into a single adjoint triple. It is clear that if this is the case then the last two properties hold. We show the converse.

First notice that the two embeddings always combine into an adjunction of the form

$$\mathbf{B}_{\text{disc}} \begin{array}{c} \xleftarrow{\text{Disc}} \\ \xrightarrow{\Gamma} \end{array} \mathbf{H} \begin{array}{c} \xrightarrow{\tilde{\Gamma}} \\ \xleftarrow{\text{coDisc}} \end{array} \mathbf{B}_{\text{cod}} .$$

The equivalence $\sharp(\flat X \rightarrow X)$ applied to $X := \text{coDisc}A$ gives that coDisc applied to the counit of this composite adjunction is an equivalence

$$\text{coDisc } \tilde{\Gamma} \text{Disc } \Gamma \text{coDisc}A \xrightarrow{\simeq} \text{coDisc } \tilde{\Gamma} \text{coDisc}A \xrightarrow{\simeq} \text{coDisc}A$$

and since coDisc is full and faithful, so is the composite counit itself. Dually, the equivalence $\flat(X \rightarrow \sharp X)$ implies that the unit of this composite adjunction is an equivalence. Hence the adjunction itself is an equivalence, and so $\mathbf{B}_{\text{disc}} \simeq \mathbf{B}_{\text{cod}}$. Using this we obtain a composite equivalence

$$\text{Disc } \tilde{\Gamma}X \xrightarrow{\simeq} \text{Disc } \Gamma \text{coDisc } \tilde{\Gamma}X \xrightarrow{\simeq} \text{Disc } \Gamma X ,$$

where the left morphism is the image under Disc of the above composite adjunction on the codiscrete object $\tilde{\Gamma}X$, and where the second is a natural inverse of $\flat(X \rightarrow \sharp X)$. Since Disc is full and faithful, this implies that

$$\Gamma \simeq \tilde{\Gamma} .$$

□

This formulation of cohesion is not entirely internal yet, since it still refers to the external hom ∞ -groupoids \mathbf{H} . But cohesion also implies that the external ∞ -groupoids can be re-internalized.

Proposition 3.4.16. *The statement of theorem 3.4.15 remains true with items 2. a) - 2. b) replaced by*

2. (a') $\sharp[\mathbf{\Pi}X, Y] \rightarrow \sharp[X, Y]$;
2. (b') $\sharp[Y, \flat X] \rightarrow \sharp[Y, X]$;
2. (c') $[\sharp X, \tilde{Y}] \rightarrow [X, \tilde{Y}]$;

where $[-, -]$ denotes the internal hom in \mathbf{H} .

Proof. By prop. 3.7.2 we have for codiscrete \tilde{Y} equivalences $[X, \tilde{Y}] \simeq \text{coDisc}\mathbf{H}(X, \tilde{Y})$. Since coDisc is full and faithful, the morphism $\mathbf{H}(\sharp X, \tilde{Y}) \rightarrow \mathbf{H}(X, \tilde{Y})$ is an equivalence precisely if $[\sharp X, \tilde{Y}] \rightarrow [X, \tilde{Y}]$ is.

Generally, we have $\Gamma[X, Y] \simeq \mathbf{H}(X, Y)$. With the full and faithfulness of coDisc this similarly gives the remaining statements. □

3.4.2 Presentation

We discuss presentations of cohesive ∞ -toposes, in the sense of presentation of ∞ -toposes as discussed in 2.2.3. In 3.4.2.1 we consider sites such that the ∞ -topos of ∞ -sheaves over them is cohesive. In 3.4.2.2 we analyze fibrancy and descent over these sites. These considerations serve as the basis for the construction of models of cohesion below in 4.

3.4.2.1 Presentation over ∞ -cohesive sites We discuss a class of sites with the property that the ∞ -toposes of ∞ -sheaves over them (2.2.3) are cohesive, def. 3.4.1.

Definition 3.4.17. An ∞ -cohesive site is a site such that

1. it has finite products;
2. every object $U \in C$ has at least one point: $C(*, U) \neq \emptyset$;
3. for every covering family $\{U_i \rightarrow U\}$ its Čech nerve $C(\{U_i\}) \in [C^{\text{op}}, \text{sSet}]$ is degreewise a coproduct of representables
4. the canonical morphisms $C(\{U_i\}) \rightarrow U$ are taken to weak equivalences by both limit and colimit $[C^{\text{op}}, \text{sSet}] \rightarrow \text{sSet}$:

$$\begin{aligned} \lim_{\rightarrow} C(\{U_i\}) &\xrightarrow{\simeq} \lim_{\rightarrow} U_i \\ \lim_{\leftarrow} C(\{U_i\}) &\xrightarrow{\simeq} \lim_{\leftarrow} U_i \end{aligned}$$

Notice that for the representable U we have $\lim_{\rightarrow} U \simeq *$ and that since C is assumed to have finite products and hence in particular a terminal object $\lim_{\leftarrow} U = C(*, U)$.

Proposition 3.4.18. *The ∞ -sheaf ∞ -topos over an ∞ -cohesive site is a cohesive ∞ -topos in which for all objects pieces have points, def. 3.4.8.*

Proof. Since an ∞ -cohesive site is in particular a locally and globally ∞ -connected site (def. 3.3.6) it follows with theorem 3.3.7 that Π exists and preserves the terminal object. Moreover, by the discussion there Π acts by sending a fibrant-cofibrant simplicial presheaf $F : C^{\text{op}} \rightarrow \text{sSet}$ to its colimit. Since C is assumed to have finite products, C^{op} has finite coproducts, hence is a sifted category. Therefore taking colimits of functors on C^{op} commutes with taking products of these functors. Since the ∞ -product of ∞ -presheaves is modeled by the ordinary product on fibrant simplicial presheaves, it follows that over an ∞ -cohesive site Π indeed exhibits a strongly ∞ -connected ∞ -topos.

Using the notation and results of the proof of theorem 3.3.7, we show that the further right adjoint Δ exists by exhibiting a suitable right Quillen adjoint to $\Gamma : [C^{\text{op}}, \text{sSet}] \rightarrow \text{sSet}$, which is given by evaluation on the terminal object. Its sSet -enriched right adjoint is given by

$$\nabla S : U \mapsto \text{sSet}(\Gamma(U), S)$$

as confirmed by the following end/coend computation:

$$\begin{aligned} (X, \nabla(S)) &= \int_{U \in C} \text{sSet}(X(U), \text{sSet}(\Gamma(U), S)) \\ &= \int_{U \in C} \text{sSet}(X(U) \times \Gamma(U), S) \\ &= \text{sSet}\left(\int^{U \in C} X(U) \times \Gamma(U), S\right), \\ &= \text{sSet}\left(\int^{U \in C} X(U) \times \text{Hom}_C(*, U), S\right) \\ &= \text{sSet}(X(*), S) \\ &= \text{sSet}(\Gamma(X), S) \end{aligned}$$

We have that

$$(\Gamma \dashv \nabla) : [C^{\text{op}}, \text{sSet}]_{\text{proj}} \xrightleftharpoons[\nabla]{\Gamma} \text{sSet}_{\text{Quillen}}$$

is a Quillen adjunction, since ∇ manifestly preserves fibrations and acyclic fibrations. Since $[C^{\text{op}}, \text{sSet}]_{\text{proj,loc}}$ is a left proper model category, to see that this descends to a Quillen adjunction on the local model structure it is sufficient by prop. 2.1.40 to check that $\nabla : \text{sSet}_{\text{Quillen}} \rightarrow [C^{\text{op}}, \text{sSet}]_{\text{proj,loc}}$ preserves fibrant objects, in that for S a Kan complex we have that ∇S satisfies descent along Čech nerves of covering families.

This is implied by the second defining condition on the ∞ -local site C , that $\lim_{\leftarrow} C(\{U_i\}) = \text{Hom}_C(*, C(\{U_i\})) \simeq \text{Hom}_C(*, U) = \lim_{\leftarrow} U$ is a weak equivalence. Using this we have for fibrant $S \in \text{sSet}_{\text{Quillen}}$ the descent weak equivalence

$$\begin{aligned} [C^{\text{op}}, \text{sSet}](U, \nabla S) &= \text{sSet}(\text{Hom}_C(*, U), S) \\ &\simeq \text{sSet}(\text{Hom}_C(*, C(U)), S), \\ &= [C^{\text{op}}, \text{sSet}](C(U), \nabla S) \end{aligned}$$

where we use in the middle step that $\text{sSet}_{\text{Quillen}}$ is a simplicial model category so that homming the weak equivalence between cofibrant objects into the fibrant object S indeed yields a weak equivalence.

It remains to show that *pieces have points*, def. 3.4.8, in $\text{Sh}_{\infty}(C)$. For the first statement we use the cofibrant replacement theorem from [Dug01] for $[C^{\text{op}}, \text{sSet}]_{\text{proj,loc}}$ which says that for X any simplicial presheaf, a functorial projective cofibrant replacement is given by the object

$$QX := \left(\cdots \rightrightarrows \coprod_{U_0 \rightarrow U_1 \rightarrow X_1} U_0 \rightrightarrows \coprod_{U_0 \rightarrow X_0} U_0 \right),$$

where the coproducts are over the set of morphisms of presheaves from representables U_i as indicated. By the above discussion, the presentations of Γ and Π by left Quillen functors \lim_{\leftarrow} and \lim_{\rightarrow} takes this to the morphism $\lim_{\leftarrow} QX \rightarrow \lim_{\rightarrow} QX$ induced in components by

$$\begin{array}{ccc} \cdots \rightrightarrows \coprod_{U_0 \rightarrow U_1 \rightarrow X_1} C(*, U_0) & \rightrightarrows & \coprod_{U_0 \rightarrow X_0} C(*, U_0) \\ \downarrow & & \downarrow \\ \cdots \rightrightarrows \coprod_{U_0 \rightarrow U_1 \rightarrow X_1} * & \rightrightarrows & \coprod_{U_0 \rightarrow X_0} * \end{array}$$

By assumption on C we have that all sets $C(*, U_0)$ are non-empty, so that this is componentwise an epimorphism and hence induces in particular an epimorphism on connected components.

Finally, for S a Kan complex we have by the above that $\text{Disc}S$ is the presheaf constant on S . Its homotopy sheaves are the presheaves constant on the homotopy groups of S . The inclusion of these into the homotopy sheaves of $\text{coDisc}S$ is over each $U \in C$ the diagonal injection

$$\pi_n(S, x) \hookrightarrow \pi_n(S, x)^{C(*, U)}.$$

Therefore also *discrete objects are concrete* in the ∞ -topos over the ∞ -cohesive site C . □

Below in 4 we discuss in detail the following examples.

Examples 3.4.19. The following sites are ∞ -cohesive.

- The site $\text{CartSp}_{\text{top}}$ of Cartesian spaces, continuous maps between them and good open covers (prop. 4.3.2).
- The site $\text{CartSp}_{\text{smooth}}$ of Cartesian spaces, smooth maps between them and good open covers (prop. 4.4.6),
- The site $\text{CartSp}_{\text{SynthDiff}}$ of Cartesian spaces with infinitesimal thickening, smooth maps between them and good open covers that are the identity on the thickening (prop. 4.5.8).

- The site $\text{CartSp}_{\text{super}}$ of super-Cartesian spaces, morphisms of supermanifolds between them and good open covers.

We record a fact that is expected to hold quite generally for ∞ -toposes, but for which we currently have a proof only over ∞ -connected sites.

Theorem 3.4.20 (parameterized ∞ -Grothendieck construction). *Let \mathbf{H} be an ∞ -topos with an ∞ -connected site of definition, def. 3.3.6, and let $A \in \infty\text{Grpd}$ be any ∞ -groupoid. Then there is an equivalence of ∞ -categories*

$$\mathbf{H}/_{\text{Disc}A} \simeq \mathbf{H}^A$$

between the slice ∞ -topos of \mathbf{H} over the discrete cohesive ∞ -groupoid on A and the ∞ -category of ∞ -functors $A \rightarrow \mathbf{H}$.

Proof. For the case that the site of definition is terminal, hence that $\mathbf{H} \simeq \infty\text{Grpd}$ this statement is the ∞ -Grothendieck construction from section 2 of [L-Topos]. There the equivalence of ∞ -categories

$$\infty\text{Grpd}/_A \simeq \infty\text{Grpd}^A$$

which takes a fibration to an ∞ -functor that assigns its fibers is presented by a Quillen equivalence of model categories

$$\text{sSet}^+/A \rightleftarrows [w(A)^{\text{op}}, \text{sSet}]_{\text{proj}}$$

between a model structure on *marked simplicial sets* sSet^+ over a Kan complex A and the global projective model structure on enriched presheaves on the simplicially enriched category $w(A)$ corresponding to A by the discussion in section 1.1.5 of [L-Topos].

Now for C an ∞ -connected site and $\mathbf{H} \simeq ([C^{\text{op}}, \text{sSet}]_{\text{proj,loc}})^{\circ}$ we have by the proof of prop. 3.3.7 that with A a Kan complex, the constant simplicial presheaf $\text{const}A : C^{\text{op}} \rightarrow \text{sSet}$ is a fibrant presentation in $[C^{\text{op}}, \text{sSet}]_{\text{proj,loc}}$ of $\text{Disc}A$. Therefore the ∞ -categorical slice $\mathbf{H}/_{\text{Disc}A}$ is presented by the induced model structure on the 1-categorical slice category

$$\mathbf{H}/_{\text{Disc}A} \simeq \left(([C^{\text{op}}, \text{sSet}]_{\text{const}A})_{\text{proj,loc}/\text{const}A} \right)^{\circ}.$$

We have an evident equivalence of 1-categories

$$[C^{\text{op}}, \text{sSet}]_{\text{const}A} \simeq [C^{\text{op}}, \text{sSet}/_A]$$

under which the above slice model structure is seen to become the model structure on presheaves with values in the slice model structure $(\text{sSet}/_A)_{\text{Quillen}/A}$, hence

$$\mathbf{H}/_{\text{Disc}A} \simeq \left([C^{\text{op}}, (\text{sSet}/_A)_{\text{Quillen}/A}]_{\text{proj,loc}} \right)^{\circ}.$$

Since A is fibrant in the Quillen model structure, the slice model structure here presents the ∞ -categorical slice of ∞ -groupoids

$$\infty\text{Grpd}/_A \simeq \left((\text{sSet}/_A)_{\text{Quillen}/A} \right)^{\circ}.$$

By the above presentation of the ∞ -Grothendieck construction by marked simplicial sets, this is equivalently

$$\dots \simeq (\text{sSet}^+/A)^{\circ} \simeq ([w(A)^{\text{op}}, \text{sSet}]_{\text{proj}})^{\circ}.$$

Since all model categories appearing here are combinatorial, it follows with prop. 4.2.4.4 in [L-Topos] that we have an equivalence of ∞ -categories

$$\mathbf{H}/_{\text{Disc}A} \simeq ([C^{\text{op}}, [w(A)^{\text{op}}, \text{sSet}]_{\text{proj}}]_{\text{proj,loc}})^{\circ}$$

and hence

$$\dots \simeq ([w(A)^{\text{op}}, [C^{\text{op}}, \text{sSet}]_{\text{proj,loc}}]_{\text{proj}})^{\circ} \simeq \mathbf{H}^A.$$

□

3.4.2.2 Fibrancy over ∞ -cohesive sites The condition on an object $X \in [C^{\text{op}}, \text{sSet}]_{\text{proj}}$ to be fibrant models the fact that X is an ∞ -presheaf of ∞ -groupoids. The condition that X is also fibrant as an object in $[C^{\text{op}}, \text{sSet}]_{\text{proj,loc}}$ models the higher analog of the sheaf condition: it makes X an ∞ -sheaf. For generic sites C fibrancy in the local model structure is a property rather hard to check or establish concretely. But often a given site can be replaced by another site on which the condition is easier to control, without changing the corresponding ∞ -topos, up to equivalence. Here we discuss for cohesive sites, def. 3.4.17 explicit conditions for a simplicial presheaf over them to be fibrant.

In order to discuss descent over C it is convenient to introduce the following notation for “cohomology over the site C ”. For the moment this is just an auxiliary technical notion. Later we will see how it relates to an intrinsically defined notion of cohomology.

Definition 3.4.21. For C an ∞ -cohesive site, $A \in [C^{\text{op}}, \text{Set}]_{\text{proj}}$ fibrant, and $\{U_i \rightarrow U\}$ a good cover in U , we write

$$H_C^n(\{U_i\}, A) := \pi_0 \text{Maps}(C(\{U_i\}), A).$$

Moreover, if A is equipped with (abelian) group structure we write

$$H_C^n(\{U_i\}, A) := \pi_0 \text{Maps}(C(\{U_i\}), \overline{W}^n A).$$

Definition 3.4.22. An object $A \in [C^{\text{op}}, \text{sSet}]$ is called C -acyclic if

1. it is fibrant in $[C^{\text{op}}, \text{sSet}]_{\text{proj}}$;
2. for all $n \in \mathbb{N}$ the homotopy group presheaves π_n^{PSh} from def. 2.2.7 are already sheaves $\pi_n(A) \in \text{Sh}(C)$;
3. for $n = 1$ and $k = 1$ as well as $n \geq 2$ and $k \geq 1$ we have $H_C^k(\{U_i\}, \pi_n(A)) \simeq *$ for all good covers $\{U_i \rightarrow U\}$.

Remark 3.4.23. This definition can be formulated and the following statements about it are true over any site whatsoever. However, on generic sites C the C -acyclic objects are not very interesting. On ∞ -cohesive sites on the other hand they are of central importance.

Observation 3.4.24. If A is C -acyclic then for every point $x : * \rightarrow A$ also $\Omega_x A$ is C -acyclic (for any model of the loop space object in $[C^{\text{op}}, \text{sSet}]_{\text{proj}}$).

Proof. The standard statement in $\text{sSet}_{\text{Quillen}}$

$$\pi_n \Omega X \simeq \pi_{n+1} X$$

directly prolongs to $[C^{\text{op}}, \text{sSet}]_{\text{proj}}$. □

Theorem 3.4.25. Let C be an ∞ -cohesive site. Sufficient conditions for an object $A \in [C^{\text{op}}, \text{sSet}]$ to be fibrant in the local model structure $[C^{\text{op}}, \text{sSet}]_{\text{proj,loc}}$ are

- A is 0-truncated and C -acyclic;
- A is connected and C -acyclic;
- A is a group object and C -acyclic.

Here and in the following “truncated” and “connected” are as simplicial presheaves (not after sheafification of homotopy presheaves).

We demonstrate this statement in several stages.

Proposition 3.4.26. A 0-truncated object is fibrant in $[C^{\text{op}}, \text{sSet}]_{\text{proj,loc}}$ precisely if it is fibrant in $[C^{\text{op}}, \text{sSet}]_{\text{proj}}$ and weakly equivalent to a sheaf: to an object in the image of the canonical inclusion

$$\text{Sh}_C \hookrightarrow [C^{\text{op}}, \text{Set}] \hookrightarrow [C^{\text{op}}, \text{sSet}].$$

Proof. From general facts of left Bousfield localization we have that the fibrant objects in the local model structure are necessarily fibrant also in the global structure.

Since moreover $A \rightarrow \pi_0(A)$ is a weak equivalence in the global model structure by assumption, we have for every covering $\{U_i \rightarrow U\}$ in C a sequence of weak equivalences

$$\text{Maps}(C(\{U_i\}), A) \xrightarrow{\simeq} \text{Maps}(C(\{U_i\}), \pi_0(A)) \xrightarrow{\simeq} \text{Maps}(\pi_0 C(\{U_i\}), \pi_0(A)) \xrightarrow{\simeq} \text{Sh}_C(S(\{U_i\}), \pi_0(A)),$$

where $S(\{U_i\}) \hookrightarrow U$ is the sieve corresponding to the cover. Therefore the descent condition

$$\text{Maps}(U, A) \xrightarrow{\simeq} \text{Maps}(C(\{U_i\}), A)$$

is precisely the sheaf condition for $\pi_0(A)$. \square

Proposition 3.4.27. *A connected fibrant object $A \in [C^{\text{op}}, \text{sSet}]_{\text{proj}}$ is fibrant in $[C^{\text{op}}, \text{sSet}]_{\text{proj}, \text{loc}}$ if for all objects $U \in C$*

1. $H_C(U, A) \simeq *$;
2. ΩA is fibrant in $[C^{\text{op}}, \text{sSet}]_{\text{proj}, \text{loc}}$,

where ΩA is any fibrant object in $[C^{\text{op}}, \text{sSet}]_{\text{proj}}$ representing the looping of A .

Proof. For $\{U_i \rightarrow U\}$ a covering we need to show that the canonical morphism

$$\text{Maps}(U, A) \rightarrow \text{Maps}(C(\{U_i\}), A)$$

is a weak homotopy equivalence. This is equivalent to the two morphisms

1. $\pi_0 \text{Maps}(U, A) \rightarrow \pi_0 \text{Maps}(C(\{U_i\}), A)$
2. $\Omega \text{Maps}(U, A) \rightarrow \Omega \text{Maps}(C(\{U_i\}), A)$

being weak equivalences. Since A is connected the first of these says that there is a weak equivalence $*$ $\xrightarrow{\simeq} H_C(U, A)$. The second condition is equivalent to $\text{Maps}(U, \Omega A) \rightarrow \text{Maps}(C(\{U_i\}), \Omega A)$, being a weak equivalence, hence to the descent of ΩA . \square

Proposition 3.4.28. *An object A which is connected, 1-truncated and C -acyclic is fibrant in $[C^{\text{op}}, \text{sSet}]_{\text{proj}, \text{loc}}$.*

Proof. Observe that for a connected and 1-truncated objects we have a weak equivalence $A \simeq \overline{W}\pi_1(A)$ in $[C^{\text{op}}, \text{sSet}]_{\text{proj}}$. The first condition of prop. 3.4.27 is then implied by C -connectedness. The second condition there is that $\pi_1(A)$ satisfies descent. By C -acyclicity this is a sheaf and it is 0-truncated by assumption, therefore it satisfies descent by prop 3.4.26. \square

Proposition 3.4.29. *Every connected and C -acyclic object $A \in [C^{\text{op}}, \text{sSet}]_{\text{proj}}$ is fibrant in $[C^{\text{op}}, \text{sSet}]_{\text{proj}, \text{loc}}$.*

Proof. We first show the statement for truncated A and afterwards for the general case.

The k -truncated case in turn we consider by induction over k . If A is 1-truncated the proposition holds by prop. 3.4.28. Assuming then that the statement has been shown for k -truncated A , we need to show it for $(k+1)$ -truncated A .

This we do by decomposing A into its canonical Postnikov tower def. 3.6.25: For $n \in \mathbb{N}$ let

$$A(n) := A/\sim_n$$

be the quotient simplicial presheaf where two cells

$$\alpha, \beta : \Delta^n \times U \rightarrow A$$

are identified, $\alpha \sim_n \beta$, precisely if they agree on their n -skeleton:

$$\text{sk}_n \alpha = \text{sk}_n \beta : \text{sk}_n \Delta \hookrightarrow \Delta^n \rightarrow A(U).$$

It is a standard fact (shown in [GoJa99], theorem VI 3.5 for simplicial sets, which generalizes immediately to the global model structure $[C^{\text{op}}, \text{sSet}]_{\text{proj}}$) that for all $n > 1$ we have sequences

$$K(n) \rightarrow A(n) \rightarrow A(n-1),$$

where $A(n-1)$ is $(n-1)$ -truncated with homotopy groups in degree $\leq n-1$ those of A , and where the right morphism is a Kan fibration and the left morphism is its kernel, such that

$$A = \lim_{\longleftarrow n} A(n).$$

Moreover, there are canonical weak homotopy equivalences

$$K(n) \rightarrow \Xi((\pi_{n-1} A)[n])$$

to the Eilenberg-MacLane object on the n th homotopy group in degree n .

Since $A(n-1)$ is $(n-1)$ -truncated and connected, the induction assumption implies that it is fibrant in the local model structure.

Moreover we see that $K(n)$ is fibrant in $[C^{\text{op}}, \text{sSet}]_{\text{proj,loc}}$: the first condition of 3.4.27 holds by the assumption that A is C -connected. The second condition is implied again by the induction hypothesis, since $\Omega K(n)$ is $(n-1)$ -truncated, connected and still C -acyclic, by observation 3.4.24.

Therefore in the diagram (where $\text{Maps}(-, -)$ denotes the simplicial hom complex)

$$\begin{array}{ccccc} \text{Maps}(U, K(n)) & \longrightarrow & \text{Maps}(U, A(n)) & \longrightarrow & \text{Maps}(U, A(n-1)) \\ \downarrow \simeq & & \downarrow & & \downarrow \simeq \\ \text{Maps}(C(\{U_i\}), K(n)) & \longrightarrow & \text{Maps}(C(\{U_i\}), A(n)) & \longrightarrow & \text{Maps}(C(\{U_i\}), A(n-1)) \end{array}$$

for $\{U_i \rightarrow U\}$ any good cover in C the top and bottom rows are fiber sequences (notice that all simplicial sets in the top row are connected because A is connected) and the left and right vertical morphisms are weak equivalences in $[C^{\text{op}}, \text{sSet}]_{\text{proj}}$ (the right one since $A(n-1)$ is fibrant in the local model structure by induction hypothesis, as remarked before, and the left one by C -acyclicity of A). It follows that also the middle morphism is a weak equivalence. This shows that $A(n)$ is fibrant in $[C^{\text{op}}, \text{sSet}]_{\text{proj,loc}}$. By completing the induction the same then follows for the object A itself.

This establishes the claim for truncated A . To demonstrate the claim for general A notice that the limit over a sequence of fibrations between fibrant objects is a homotopy limit (by example 2.3.16). Therefore we have

$$\begin{array}{ccc} \text{Maps}(U, A) & \simeq & \lim_{\longleftarrow n} \text{Maps}(U, A(n)) \\ \downarrow & & \downarrow \simeq \\ \text{Maps}(C(\{U_i\}), A) & \simeq & \lim_{\longleftarrow n} \text{Maps}(C(\{U_i\}), A(n)) \end{array},$$

where the right vertical morphism is a morphism between homotopy limits in $[C^{\text{op}}, \text{sSet}]_{\text{proj}}$ induced by a weak equivalence of diagrams, hence is itself a weak equivalence. Therefore A is fibrant in $[C^{\text{op}}, \text{sSet}]_{\text{proj,loc}}$. \square

Lemma 3.4.30. For $G \in [C^{\text{op}}, \text{sSet}]$ a group object, the canonical sequence

$$G_0 \rightarrow G \rightarrow G/G_0$$

is a homotopy fiber sequence in $[C^{\text{op}}, \text{sSet}]_{\text{proj}}$.

Proof. Since homotopy pullbacks of presheaves are computed objectwise, it is sufficient to show this for $C = *$, hence in $\text{sSet}_{\text{Quillen}}$. One checks that generally, for X a Kan complex and G a simplicial group acting on X , the quotient morphism $X \rightarrow X/G$ is a Kan fibration. Therefore the homotopy fiber of $G \rightarrow G/G_0$ is presented by the ordinary fiber in sSet . Since the action of G_0 on G is free, this is indeed $G_0 \rightarrow G$. \square

Proposition 3.4.31. Every C -acyclic group object $G \in [C^{\text{op}}, \text{sSet}]_{\text{proj}}$ for which G_0 is a sheaf is fibrant in $[C^{\text{op}}, \text{sSet}]_{\text{proj,loc}}$.

Proof. By lemma 3.4.30 we have a fibration sequence

$$G_0 \rightarrow G \rightarrow G/G_0.$$

Since G_0 is assumed to be a sheaf it is fibrant in the local model structure by prop. 3.4.26. Since G/G_0 is evidently connected and C -acyclic it is fibrant in the local model structure by prop. 3.4.29. As before in the proof there this implies that also G is fibrant in the local model structure. \square

We discuss some examples.

Proposition 3.4.32. Let $(\delta : G_1 \rightarrow G_0)$ be a crossed module, def. 1.2.74, of sheaves over an ∞ -cohesive site C . Then the simplicial delooping $\bar{W}(G_1 \rightarrow G_0)$ is fibrant in $[C^{\text{op}}, \text{sSet}]_{\text{proj,loc}}$ if the image factorization of $G_0 \times G_1 \rightarrow G_0 \times G_0$ has sections over each $U \in C$ and if the presheaf $\ker \delta$ is a sheaf.

Proof. The existence of the lift ensures that the homotopy presheaf $\pi_1^{\text{PSh}} \bar{W}G$ is a sheaf. Notice that $\pi_2^{\text{PSh}} \bar{W}G = \ker(\delta)$. Since moreover $\bar{W}G$ is manifestly connected, the claim follows with theorem 3.4.25. \square

3.5 Differential cohesive ∞ -toposes

We discuss extra structure on a cohesive ∞ -topos that encodes a refinement of the corresponding notion of cohesion to a notion of what may be called *infinitesimal cohesion* or *differential cohesion*. With respect to such it makes sense to ask if an object in the topos has *infinitesimal extension*.

A basic class of examples of objects with infinitesimal extension are *infinitesimal intervals* \mathbb{D} that arise, in the presence of infinitesimal cohesion, from *line objects* \mathbb{A} as the subobjects $\mathbb{D} \hookrightarrow \mathbb{A}$ of elements that square to 0 (in the internal logic of the topos)

$$\mathbb{D} = \{x \in \mathbb{A} \mid x \cdot x = 0\}.$$

These objects co-represent tangent spaces, in that for any other object X the internal hom object $TX := [\mathbb{D}, X]$ plays the role of the *tangent bundle* of X .

A well-known proposal for an axiomatic characterization of infinitesimal objects in a 1-topos goes by the name *synthetic differential geometry* [Law97], where infinitesimal extension is characterized by algebraic properties of dual function algebras, as above. From the point of view and in the presence of cohesion in an ∞ -topos, however, there is a more immediate geometric characterization: an object \mathbb{D} in a cohesive ∞ -topos \mathbf{H} behaves like a possibly infinitesimally thickened point if

1. it is geometrically contractible, $\Pi(\mathbb{D}) \simeq *$;
2. it has a single global point, $\Gamma(\mathbb{D}) \simeq *$.

This axiomatization we discuss in the following. We show that it formalizes a modern refinement of infinitesimal calculus called *D-geometry* [BeDr04] [L-DGeo].

More precisely, we consider geometric inclusions $\mathbf{H} \hookrightarrow \mathbf{H}_{\text{th}}$ of cohesive ∞ -toposes that exhibit the objects of \mathbf{H}_{th} as infinitesimal cohesive neighbourhoods of objects in \mathbf{H} . Equivalently, if the cohesive ∞ -topos \mathbf{H} is itself regarded as a fat point by prop. 3.4.3, then \mathbf{H}_{th} is an infinitesimal thickening of that fat point itself. Below in 3.10.9 we furthermore consider the ∞ -cofiber \mathbf{H}_{inf} of this inclusion

$$\begin{array}{ccc} \mathbf{H} & \hookrightarrow & \mathbf{H}_{\text{th}} \\ \downarrow & & \downarrow \\ \infty\text{Grpd} & \hookrightarrow & \mathbf{H}_{\text{inf}} \end{array} .$$

This cofiber is interpreted accordingly as the respective infinitesimal thickening of the absolute point. We observe in 4.5.1.4 that the sub- ∞ -category of globally trivial objects of \mathbf{H}_{inf} is equivalent to that of L_∞ -algebras, by the theory of “formal moduli problems” of [L-Lie]. Moreover, the reflection along

$$\text{Grp}(\mathbf{H}_{\text{th}}) \simeq (\mathbf{H}_{\text{th}})_{\geq 1}^{*/} \longrightarrow (\mathbf{H}_{\text{inf}})_{\geq 1}^{*/}$$

is Lie differentiation, sending a cohesive ∞ -group to the L_∞ -algebra that approximates it infinitesimally.

Below in 3.10 we discuss a list of structures that are canonically present in infinitesimal cohesive neighbourhoods.

Further below in 4.5 we discuss a model for these axioms by *synthetic differential ∞ -groupoids* which is an ∞ -categorical generalization of a topos that is a model for *synthetic differential geometry*. In this model the above ∞ -cofiber sequence of cohesive ∞ -toposes reads

$$\text{Smooth}\infty\text{Grpd} \hookrightarrow \text{SynthDiff}\infty\text{Grpd} \twoheadrightarrow \text{Inf}\infty\text{Grpd} ,$$

where on the right we have “infinitesimal ∞ -groupoids” (essentially the “formal moduli problems” of [L-Lie]), which are infinitesimally cohesive. This is prop. 4.5.35 below.

A similar model, differing by the existence of a grading on the infinitesimals, is that of supergeometric ∞ -groupoids, discussed below in 4.6. There the ∞ -cofiber sequence of cohesive ∞ -toposes reads

$$\text{Smooth}\infty\text{Grpd} \hookrightarrow \text{SmoothSuper}\infty\text{Grpd} \twoheadrightarrow \text{Super}\infty\text{Grpd} ,$$

where on the right we have bare but “super” ∞ -groupoids, an infinitesimally cohesive ∞ -topos whose internal algebra is superalgebra. This is prop. 4.6.13 below.

3.5.1 General abstract

Definition 3.5.1. Given a cohesive ∞ -topos \mathbf{H} we say that an *infinitesimal cohesive neighbourhood* of \mathbf{H} is a geometric embedding $i : \mathbf{H} \hookrightarrow \mathbf{H}_{\text{th}}$ into another cohesive ∞ -topos \mathbf{H}_{th} , such that there is an extra left adjoint $i_!$ (necessarily also full and faithful) and an extra right adjoint $i^!$

$$(i_! \dashv i^* \dashv i_* \dashv i^!) : \begin{array}{ccc} & \hookrightarrow^{i_!} & \\ \mathbf{H} & \xleftarrow{i^*} \xrightarrow{i_*} & \mathbf{H}_{\text{th}} \\ & \xleftarrow{i^!} & \end{array}$$

and such that $i_!$ preserves finite products.

When we think of this as exhibiting extra structure on \mathbf{H}_{th} , we call \mathbf{H}_{th} equipped with this embedding a *differential cohesive ∞ -topos* or *differential ∞ -topos* for short.

Remark 3.5.2. This definition captures the characterization of infinitesimal objects as having a single global point surrounded by an infinitesimal neighbourhood: as we discuss in detail below in 3.10.1, the ∞ -functor i^* may be thought of as contracting away any infinitesimal extension of an object. Thus X being an infinitesimal object amounts to $i^*X \simeq *$, and the ∞ -adjunction $(i_! \dashv i^*)$ then implies that X has only a single global point, since

$$\begin{aligned} \mathbf{H}_{\text{th}}(*, X) &\simeq \mathbf{H}_{\text{th}}(i_!*, X) \\ &\simeq \mathbf{H}(*, i^*X) \\ &\simeq \mathbf{H}(*, *) \\ &\simeq * \end{aligned}$$

Observation 3.5.3. The inclusion into the infinitesimal neighbourhood is necessarily a morphism of ∞ -toposes over ∞Grpd .

$$\begin{array}{ccc} \mathbf{H} & \xrightarrow{(i^* \dashv i_*)} & \mathbf{H}_{\text{th}} \\ & \searrow \Gamma_{\mathbf{H}} & \swarrow \Gamma_{\mathbf{H}_{\text{th}}} \\ & \infty\text{Grpd} & \end{array}$$

as is the induced ∞ -geometric morphism $(i_* \dashv i^!) : \mathbf{H}_{\text{th}} \rightarrow \mathbf{H}$:

$$\begin{array}{ccc} \mathbf{H}_{\text{th}} & \xrightarrow{(i_* \dashv i^!)} & \mathbf{H} \\ & \searrow \Gamma_{\mathbf{H}_{\text{th}}} & \swarrow \Gamma_{\mathbf{H}} \\ & \infty\text{Grpd} & \end{array}$$

Proof. By essential uniqueness of the terminal global section geometric morphism, prop. 2.2.4. In both cases the direct image functor has as left adjoint that preserves the terminal object. Therefore we compute in the first case

$$\begin{aligned} \Gamma_{\mathbf{H}_{\text{th}}}(i_*X) &\simeq \mathbf{H}_{\text{th}}(*, i_*X) \\ &\simeq \mathbf{H}(i^**, X) \\ &\simeq \mathbf{H}(*, X) \\ &\simeq \Gamma_{\mathbf{H}}(X) \end{aligned}$$

and analogously in the second. □

Definition 3.5.4. For $(i_! \dashv i^* \dashv i_* \dashv i^!) : \mathbf{H} \rightarrow \mathbf{H}_{\text{th}}$ an infinitesimal neighbourhood of a cohesive ∞ -topos, we write

$$(\Pi_{\text{inf}} \dashv \text{Disc}_{\text{inf}} \dashv \Gamma_{\text{inf}}) := (i^* \dashv i_* \dashv i^!),$$

so that the locally connected terminal geometric morphism of \mathbf{H}_{th} factors as

$$(\Pi_{\mathbf{H}_{\text{th}}} \dashv \text{Disc}_{\mathbf{H}_{\text{th}}} \dashv \flat_{\mathbf{H}_{\text{th}}}) : \mathbf{H}_{\text{th}} \begin{array}{c} \xleftarrow{\text{Red}} \\ \xleftarrow{\Pi_{\text{inf}}} \\ \xleftarrow{\text{Disc}_{\text{inf}}} \\ \xrightarrow{\Gamma_{\text{inf}}} \end{array} \mathbf{H} \begin{array}{c} \xrightarrow{\Pi_{\mathbf{H}}} \\ \xleftarrow{\text{Disc}_{\mathbf{H}}} \\ \xrightarrow{\Gamma_{\mathbf{H}}} \\ \xleftarrow{\text{coDisc}} \end{array} \infty\text{Grpd} .$$

The interrelation between overlapping adjoint triples here is discussed in more detail below in 3.10.1. As a simple class of examples we record:

Proposition 3.5.5. *If \mathbf{H} is an infinitesimally cohesive ∞ -topos over ∞Grpd def. 3.4.13, then it is also enjoys differential cohesion relative to ∞Grpd .*

Proof. By the properties of infinitesimal cohesion the composite

$$\begin{array}{ccc} \xrightarrow{\quad} & \xrightarrow{\quad} & \\ \infty\mathrm{Grpd} \xleftarrow{\quad} & \mathbf{H} & \xrightarrow{\quad} \infty\mathrm{Grpd} \\ \xleftarrow{\quad} & \xleftarrow{\quad} & \xleftarrow{\quad} \end{array}$$

is the identity adjoint quadruple, which is the one that exhibits the discrete cohesion of $\infty\mathrm{Grpd}$ over itself. \square

3.5.2 Presentations

We establish a presentation of differential ∞ -toposes, def. 3.5.1, in terms of categories of simplicial presheaves over suitable neighbourhoods of ∞ -cohesive sites.

Definition 3.5.6. Let C be an ∞ -cohesive site, def. 3.4.17. We say a site C_{th}

- equipped with a co-reflective embedding

$$(i \dashv p) : C \begin{array}{c} \xrightarrow{i} \\ \xleftarrow{p} \end{array} C_{\mathrm{th}}$$

- such that

1. i preserves finite products;
2. i preserves pullbacks along morphisms in covering families;
3. both i and p send covering families to covering families;
4. for all $\mathbf{U} \in C_{\mathrm{th}}$ and for all covering families $\{U_i \rightarrow p(\mathbf{U})\}$ in C there is a lift through p to a covering family $\{\mathbf{U}_i \rightarrow \mathbf{U}\}$ in C_{th}

is an *infinitesimal neighbourhood site* of C .

Proposition 3.5.7. Let C be an ∞ -cohesive site and let $(i \dashv p) : C \begin{array}{c} \xrightarrow{i} \\ \xleftarrow{p} \end{array} C_{\mathrm{th}}$ be an infinitesimal neighbourhood site.

Then the ∞ -category of ∞ -sheaves on C_{th} is a cohesive ∞ -topos and the restriction i^* along i exhibits it as an infinitesimal neighbourhood of the cohesive ∞ -topos over C .

$$(i_! \dashv i^* \dashv i_* \dashv i^!) : \mathrm{Sh}_\infty(C) \rightarrow \mathrm{Sh}_\infty(C_{\mathrm{th}}).$$

Moreover, $i_!$ restricts on representables to the ∞ -Yoneda embedding factoring through i :

$$\begin{array}{ccc} C & \longrightarrow & \mathrm{Sh}_\infty(C) \\ \downarrow i & & \downarrow i_! \\ C_{\mathrm{th}} & \longrightarrow & \mathrm{Sh}_\infty(C_{\mathrm{th}}) \end{array}$$

Proof. We demonstrate this in the model category presentation of $\mathrm{Sh}_\infty(C_{\mathrm{th}})$ as in the proof of prop. 3.4.18.

Consider the right Kan extension $\mathrm{Ran}_i : [C^{\mathrm{op}}, \mathrm{sSet}] \rightarrow [C_{\mathrm{th}}^{\mathrm{op}}, \mathrm{sSet}]$ of simplicial presheaves along the functor i . On an object $\mathbf{K} \in C_{\mathrm{th}}$ it is given by

$$\begin{aligned} \mathrm{Ran}_i F : \mathbf{K} &\mapsto \int_{U \in C} \mathrm{sSet}(C_{\mathrm{th}}(i(U), \mathbf{K}), F(U)) \\ &\simeq \int_{U \in C} \mathrm{sSet}(C(U, p(\mathbf{K})), F(U)) \quad , \\ &\simeq F(p(\mathbf{K})) \end{aligned}$$

where in the last step we use the Yoneda reduction-form of the Yoneda lemma.

This shows that the right adjoint to $(-) \circ i$ is itself given by precomposition with a functor, and hence has itself a further right adjoint, which gives us a total of four adjoint functors

$$[C^{\text{op}}, \text{sSet}] \begin{array}{c} \xrightarrow{\text{Lan}_i} \\ \xleftarrow{(-) \circ i} \\ \xleftarrow{(-) \circ p} \\ \xleftarrow{\text{Ran}_p} \end{array} [C_{\text{th}}^{\text{op}}, \text{sSet}] .$$

From this are induced the corresponding simplicial Quillen adjunctions on the global projective and injective model structure on simplicial presheaves

$$\begin{aligned} (\text{Lan}_i \dashv (-) \circ i) : [C^{\text{op}}, \text{sSet}]_{\text{proj}} &\xrightleftharpoons[(-) \circ i]{\text{Lan}_i} [C_{\text{th}}^{\text{op}}, \text{sSet}]_{\text{proj}} ; \\ ((-) \circ i \dashv (-) \circ p) : [C^{\text{op}}, \text{sSet}]_{\text{proj}} &\xrightleftharpoons[(-) \circ p]{(-) \circ i} [C_{\text{th}}^{\text{op}}, \text{sSet}]_{\text{proj}} ; \\ ((-) \circ p \dashv \text{Ran}_p) : [C^{\text{op}}, \text{sSet}]_{\text{inj}} &\xrightleftharpoons[\text{Ran}_p]{(-) \circ p} [C_{\text{th}}^{\text{op}}, \text{sSet}]_{\text{inj}} . \end{aligned}$$

By prop. 2.1.40, for these Quillen adjunctions to descend to the Čech-local model structure on simplicial presheaves it suffices that the right adjoints preserve locally fibrant objects.

We first check that $(-) \circ i$ sends locally fibrant objects to locally fibrant objects. To that end, let $\{U_i \rightarrow U\}$ be a covering family in C . Write $\int^{[k] \in \Delta} \Delta[k] \cdot \prod_{i_0, \dots, i_k} (j(U_{i_0}) \times_{j(U)} j(U_{i_1}) \times_{j(U)} \dots \times_{j(U)} j(U_k))$ for its Čech nerve, where j denotes the Yoneda embedding. Recall by the definition of the ∞ -cohesive site C that all the fiber products of representable presheaves here are again themselves representable, hence $\dots = \int^{[k] \in \Delta} \Delta[k] \cdot \prod_{i_0, \dots, i_k} (j(U_{i_0} \times_U U_{i_1} \times_U \dots \times_U U_k))$. Using that the left adjoint Lan_i preserves the coend and tensoring, that it restricts on representables to i and by the assumption that i preserves pullbacks along covers we have that

$$\begin{aligned} \text{Lan}_i C(\{U_i \rightarrow U\}) &\simeq \int^{[k] \in \Delta} \Delta[k] \cdot \prod_{i_0, \dots, i_k} \text{Lan}_i(j(U_{i_0} \times_U U_{i_1} \times_U \dots \times_U U_k)) \\ &\simeq \int^{[k] \in \Delta} \Delta[k] \cdot \prod_{i_0, \dots, i_k} j(i(U_{i_0} \times_U U_{i_1} \times_U \dots \times_U U_k)) \\ &\simeq \int^{[k] \in \Delta} \Delta[k] \cdot \prod_{i_0, \dots, i_k} j(i(U_{i_0}) \times_{i(U)} i(U_{i_1}) \times_{i(U)} \dots \times_{i(U)} i(U_k)) \end{aligned} .$$

By the assumption that i preserves covers, this is the Čech nerve of a covering family in C_{th} . Therefore for $F \in [C_{\text{th}}^{\text{op}}, \text{sSet}]_{\text{proj,loc}}$ fibrant we have for all coverings $\{U_i \rightarrow U\}$ in C that the descent morphism

$$i^* F(U) = F(i(U)) \xrightarrow{\simeq} [C_{\text{th}}^{\text{op}}, \text{sSet}](C(\{i(U_i)\}), F) = [C^{\text{op}}, \text{sSet}](C(\{U_i\}), i^* F)$$

is a weak equivalence.

To see that $(-) \circ p$ preserves locally fibrant objects, we apply the analogous reasoning after observing that its left adjoint $(-) \circ i$ preserves all limits and colimits of simplicial presheaves (as these are computed objectwise) and by observing that for $\{\mathbf{U}_I \xrightarrow{p_i} \mathbf{U}\}$ a covering family in C_{th} we have that its image under $(-) \circ i$ is its image under p , by the Yoneda lemma:

$$\begin{aligned} [C^{\text{op}}, \text{sSet}](K, ((-) \circ i)(\mathbf{U})) &\simeq C_{\text{th}}(i(K), \mathbf{U}) \\ &\simeq C(K, p(\mathbf{U})) \end{aligned}$$

and using that p preserves covers by assumption.

Therefore $(-)\circ i$ is a left and right local Quillen functor with left local Quillen adjoint Lan_i and right local Quillen adjoint $(-)\circ p$.

Finally to see by the above reasoning that also Ran_p preserves locally fibant objects notice that for every covering family $\{U_i \rightarrow U\}$ in C and every morphism $\mathbf{K} \rightarrow p^*U$ in C_{th} we may find a covering $\{\mathbf{K}_j \rightarrow \mathbf{K}\}$ such that we have commuting diagrams as on the left of

$$\begin{array}{ccc} \mathbf{K}_j & \longrightarrow & p^*U_{i(j)} \\ \downarrow & & \downarrow \\ \mathbf{K} & \longrightarrow & p^*U \end{array} \quad \Leftrightarrow \quad \begin{array}{ccccc} p(\mathbf{K}_j) & \xlongequal{\quad} & i^*(\mathbf{K}_j) & \longrightarrow & U_{i(j)} \\ \downarrow & & \downarrow & & \downarrow \\ p(\mathbf{K}) & \xlongequal{\quad} & i^*(\mathbf{K}) & \longrightarrow & U \end{array},$$

because by the $(i^* \dashv p^*)$ adjunction established above these correspond to the diagrams as indicated on the right, which exist by definition of coverage and the fact that, by definition, in C_{th} covers lift through p .

This implies that $\{p^*U_i \rightarrow p^*U\}$ is a *generalized cover* in the terminology of [DHS04], which by the discussion there implies that the corresponding Čech nerve projection $C(\{p^*U_i\}) \rightarrow p^*U$ is a weak equivalence in $[C_{\text{th}}^{\text{op}}, \text{sSet}]_{\text{proj,loc}}$.

This establishes the quadruple of adjoint ∞ -functors as claimed.

To see that Lan_i preserves products, use that, by the local formula for the left Kan extension, it is sufficient that for each $K \in C_{\text{th}}$ the functor

$$X \mapsto \lim_{\rightarrow} (p^{\text{op}}/K \rightarrow C^{\text{op}} \xrightarrow{X} \text{sSet})$$

preserves finite products. By a standard fact this is the case precisely if the slice category p^{op}/K is sifted. A sufficient condition for this is that it has coproducts. This is equivalent to K/p having products, and this is finally true due to the assumption that p preserves products.

It remains to see that $i_!$ is a full and faithful ∞ -functor. For that notice the general fact that left Kan extension along a full and faithful functor i satisfies $\text{Lan}_i \circ i \simeq \text{id}$. It only remains to observe that since $(-)\circ i$ is not only right but also left Quillen by the above, we have that $i^* \circ \text{Lan}_i$ applied to a cofibrant object is already the derived functor of the composite. \square

3.6 Structures in an ∞ -topos

We discuss here a list of fundamental homotopical and cohomological structures that exist in every ∞ -topos but are particularly expressive in a *local* ∞ -topos, def. 3.2.1, or rather: over a base ∞ -topos that is local. As we discuss below in 3.6.6, every local ∞ -topos has the *homotopy dimension* of the point and hence *all gerbes are delooped groups*. This means that group objects in a local ∞ -topos, discussed in 3.6.8 below, behave as *absolute structured groups* rather than as ∞ -sheaves of groups that vary over a fixed nontrivial space. This is the first central property of the *gros* toposes \mathbf{H} that we are interested in here. For every object $X \in \mathbf{H}$ the slice ∞ -topos $\mathbf{H}_{/X} \rightarrow \mathbf{H}$ is an ∞ -topos relative to its local base \mathbf{H} , but is itself in general not local. Group objects in the slice are groups parameterized over X and pointed connected objects in the slice are the ∞ -gerbes over X . This we discuss below in 3.6.15.

Structures entirely specific to local ∞ -toposes we discuss below in 3.7. Additional structures that are present if we assume that \mathbf{H} is locally ∞ -connected are discussed below in 3.8, and those in an actual cohesive ∞ -topos below in 3.9.

- 3.6.1 – Bundles
- 3.6.2 – Truncated objects and Postnikov towers
- 3.6.3 – Epi-/mono-morphisms, images and relative Postnikov systems
- 3.6.4 – Compact objects
- 3.6.5 – Homotopy
- 3.6.6 – Connected objects
- 3.6.7 – Groupoids
- 3.6.8 – Groups
- 3.6.9 – Cohomology
- 3.6.10 – Principal bundles
- 3.6.11 – Associated fiber bundles
- 3.6.12 – Sections and twisted cohomology
- 3.6.13 – Representations and group cohomology
- 3.6.14 – Extensions and twisted bundles
- 3.6.15 – Gerbes
- 3.6.16 – Relative cohomology

3.6.1 Bundles

We discuss the general notion of *bundles* or *objects in a slice* in an ∞ -topos. In the following sections this general notion is specialized to *principal bundles*, 3.6.10, and *associated fiber bundles*, 3.6.11.

3.6.1.1 General abstract For $X \in \mathbf{H}$ an object, a *bundle* over X is, in full generality, nothing but a morphism

$$\begin{array}{c} T \\ \downarrow p \\ X \end{array}$$

in \mathbf{H} with codomain X , and a *homomorphism of bundles* over X is a diagram of the form

$$\begin{array}{ccc} T_1 & \xrightarrow{\quad} & T_2 \\ & \searrow & \swarrow \\ & X & \end{array}$$

in \mathbf{H} . The full ∞ -category of bundles over X in \mathbf{H} is also called the *slice* of \mathbf{H} over X :

Definition 3.6.1. For \mathbf{H} an ∞ -category and for $X \in \mathbf{H}$ an object, the *slice ∞ -category* $\mathbf{H}/_X$ is the ∞ -pullback

$$\mathbf{H}/_X := \mathbf{H}^{\Delta[1]} \times_{\mathbf{H}} \{X\}$$

in the diagram of ∞ -categories

$$\begin{array}{ccccc} & & \Sigma_X & & \\ & & \curvearrowright & & \\ \mathbf{H}/_X & \xrightarrow{\quad} & \mathbf{H}^{\Delta[1]} & \xrightarrow{\text{dom}} & \mathbf{H} \\ & \downarrow & \downarrow \text{cod} & & \\ * & \xrightarrow{\vdash X} & \mathbf{H} & & \end{array}$$

Proposition 3.6.2. For \mathbf{H} an ∞ -topos and $X \in \mathbf{H}$, also the slice $\mathbf{H}/_X$, def. 3.6.1, is an ∞ -topos. Moreover, the forgetful ∞ -functor Σ_X in def. 3.6.1 is the extra left adjoint in an essential geometric morphism of ∞ -toposes

$$\left(\sum_X \dashv X^* \dashv \prod_X \right) : \mathbf{H}/_X \begin{array}{l} \xrightarrow{\Sigma_X} \\ \xleftarrow{X \times (-)} \\ \xrightarrow{\Pi_X} \end{array} \mathbf{H}$$

called the étale geometric morphism of $\mathbf{H}/_X$.

Here \prod_X is also called the dependent product over X and Σ_X is also called the dependent sum over X , see 2.1.1 above.

Finally, $X \times (-)$ is a cartesian closed ∞ -functor, which equivalently means that it satisfies Frobenius reciprocity: for $U \in \mathbf{H}$ and $E \in \mathbf{H}/_X$ there is a natural equivalence

$$\sum_X (E \times_X (X \times U)) \xrightarrow{\cong} \left(\sum_X E \right) \times U$$

exhibited by the canonical morphism.

This is prop. 6.3.5.1 in [L-Topos].

Example 3.6.3. The terminal object of the slice $\mathbf{H}/_X$ is given by the identity morphism on X in \mathbf{H} .

Remark 3.6.4. The interpretation of these base change functors is as follows: an object in the slice $\mathbf{H}/_X$ corresponds to a morphism into X in \mathbf{H} . The functor \sum_X picks out the domain of these morphisms: it forms

the “sum (union) of all the fibers”. Therefore an object $E \in \mathbf{H}/_X$ in the slice corresponds to a morphism of the form

$$\begin{array}{c} \sum_A E \\ \downarrow \\ X \end{array}$$

in \mathbf{H} . More generally, a morphism $f : E_1 \rightarrow E_2$ in the slice corresponds to a diagram of the form

$$\begin{array}{ccc} \sum_A E_1 & \xrightarrow{\sum_A f} & \sum_A E_2 \\ & \searrow f & \swarrow \\ & X & \end{array}$$

in \mathbf{H} .

On the other hand, the right adjoint \prod_A forms internal spaces of *sections* of these morphisms. With $E \in \mathbf{H}/_X$ as above we have

$$\prod_X E \simeq [X, \sum_X E]_{[X, X]} \times_{[X, X]} \{\text{id}\},$$

which says that $\prod_X E$ is the homotopy fiber of the projection $[X, \sum_X E] \rightarrow [X, X]$ from the internal hom space of maps from the base X to the domain $\sum_A E$, picking those morphisms in there which go to the identity on X , up to homotopy, when postcomposed with E , regarded as a morphism in \mathbf{H} .

This kind of relation also holds externally:

Proposition 3.6.5. *For $E_1, E_2 \in \mathbf{H}/_X$ two objects in a slice ∞ -topos over $X \in \mathbf{H}$, the hom ∞ -groupoid $\mathbf{H}/_X(E_1, E_2)$ between them is characterized as the homotopy fiber product*

$$\mathbf{H}/_X(E_1, E_2) \simeq \mathbf{H} \left(\sum_X E_1, \sum_X E_2 \right)_{\mathbf{H}(\sum_X E_1, X)} \times_{\mathbf{H}(\sum_X E_1, X)} \{E_1\}$$

of hom- ∞ -groupoids in \mathbf{H} , sitting in the ∞ -pullback diagram

$$\begin{array}{ccc} \mathbf{H}/_X(E_1, E_2) & \xrightarrow{\quad} & * \\ \downarrow & & \downarrow \vdash_{E_1} \\ \mathbf{H}(\sum_X E_1, \sum_X E_2) & \xrightarrow{E_2 \circ (-)} & \mathbf{H}(\sum_X E_1, X) \end{array} .$$

This appears as prop. 5.5.5.12 in [L-Topos].

Therefore the slice ∞ -topos $\mathbf{H}/_X$ may be regarded not only as living over the canonical base ∞ -topos ∞Grpd , but also as living over \mathbf{H} . As such its \mathbf{H} -valued hom is the dependent product of its internal hom.

Definition 3.6.6. For $X \in \mathbf{H}$ and $E_1, E_2 \in \mathbf{H}/_X$ we write

$$[E_1, E_2]_{\mathbf{H}} := \prod_X [E_1, E_2]$$

and speak of the \mathbf{H} -valued hom between E_1 and E_2 in the slice.

Remark 3.6.7. A global element of $\prod_X [E_1, E_2]$ corresponds again to a diagram of the form

$$\begin{array}{ccc} \sum_A E_1 & \xrightarrow{\quad} & \sum_A E_2 \\ & \searrow \swarrow & \\ & X & \end{array}$$

in \mathbf{H} . The morphism of prop. 3.6.9 sends such a global element to the top horizontal morphism $\sum_A E_1 \rightarrow \sum_A E_2$, regarded as a global element of $[\sum_A E_1, \sum_A E_2]$.

Proposition 3.6.8. *The ∞ -groupoid of global points of $[E_1, E_2]_{\mathbf{H}}$ is the slice hom $\mathbf{H}/_X(E_1, E_2)$:*

$$\mathbf{H}/_X(E_1, E_2) \simeq \Gamma([E_1, E_2]_{\mathbf{H}}) \simeq \mathbf{H}(*, [E_1, E_2]_{\mathbf{H}}) .$$

Proof. We compute

$$\begin{aligned} \mathbf{H}(*, [E_1, E_2]_{\mathbf{H}}) &\simeq \mathbf{H}/_X(* \times X, [E_1, E_2]) \\ &\simeq \mathbf{H}/_X(X \times_X E_1, E_2) \\ &\simeq \mathbf{H}/_X(E_1, E_2) \end{aligned} .$$

Here the first equivalence is that of the defining $\left((-) \times_X E_1 \dashv \prod_X\right)$ -adjunction of the dependent product, def. 3.6.2, the second is that of the $\left((-) \times_X E_1 \dashv [E_1, -]\right)$ -adjunction and the last one finally uses that X is the terminal object in $\mathbf{H}/_X$. \square

We may compare the internal hom in the slice with that in the base by the following comparison morphism.

Proposition 3.6.9. *For $X \in \mathbf{H}$ and $E_1, E_2 \in \mathbf{H}/_X$, there is a natural morphism*

$$p_X : \prod_X [E_1, E_2] \rightarrow \left[\sum_X E_1, \sum_X E_2 \right] .$$

Proof. Let $U \in \mathbf{H}$ be any object. Consider then the morphism of ∞ -groupoids given by the composite

$$\begin{aligned} \mathbf{H}\left(U, \prod_X [E_1, E_2]\right) &\simeq \mathbf{H}/_X(X^*U, [E_1, E_2]) \\ &\simeq \mathbf{H}/_X(X^*U \times E_1, E_2) \\ &\rightarrow \mathbf{H}\left(\sum_X (f^*U \times E_1), \sum_X E_2\right) \\ &\simeq \mathbf{H}\left(U \times \sum_X E_1, \sum_X E_2\right) \\ &\simeq \mathbf{H}\left(U, \left[\sum_X E_1, \sum_X E_2\right]\right) \end{aligned}$$

Here the first and last equivalences are the adjunction properties, the morphism in the middle is the relevant component of the ∞ -functor $\sum_X : \mathbf{H}/_X \rightarrow \mathbf{H}$ and the step after that uses the *Frobenius reciprocity* property of dependent sum (reflecting that X^* is a cartesian closed morphism). Since this morphism of ∞ -groupoids is natural in U , the ∞ -Yoneda lemma asserts that it is given by homming U into a morphism $\prod_X [E_1, E_2] \rightarrow [\sum_X E_1, \sum_X E_2]$ in \mathbf{H} . \square

Proposition 3.6.10. For $E_1, E_2 \in \mathbf{H}_{/X}$, there is an ∞ -pullback diagram in \mathbf{H} of the form

$$\begin{array}{ccc} [E_1, E_2]_{\mathbf{H}} & \longrightarrow & * \\ \downarrow p_X & & \downarrow \vdash E_1 \\ \left[\sum_X E_1, \sum_X E_2 \right] & \xrightarrow{E_2 \circ (-)} & \left[\sum_X E_1, X \right] \end{array} ,$$

where the left vertical projections is the morphism of prop. 3.6.9.

Proof. We may check this on a set $U \in \mathbf{H}$ of generators of \mathbf{H} (for instance the objects in a small ∞ -site of definition). Since $\mathbf{H}(U, -)$ preserves ∞ -limits (and detects them as U ranges over the set of generators), applying it to the above diagram (and using the definition $[E_1, E_2]_{\mathbf{H}} := \prod_X [E_1, E_2]$) yields the diagram

$$\begin{array}{ccc} \mathbf{H}_{/X}(U \times X, [E_1, E_2]) & \longrightarrow & * \\ \downarrow & & \downarrow \vdash (U \times X) \times_X E_1 \\ \mathbf{H}\left(U \times \sum_X E_1, \sum_X E_1\right) & \xrightarrow{\mathbf{H}(U \times \sum_X E_1)} & \mathbf{H}\left(U \times \sum_X E_1, X\right) \end{array} .$$

Here in the top left we can apply the $((-) \times_X E_1 \dashv [E_1, -])$ -adjunction equivalence

$$\mathbf{H}_{/X}(U \times X, [E_1, E_2]) \simeq \mathbf{H}_{/X}((U \times X) \times_X E_1, E_2),$$

and moreover by Frobenius reciprocity

$$\sum_X ((U \times X) \times_X E_1) \simeq U \times \sum_X E_1 .$$

Therefore the above diagrams are ∞ -pullbacks by prop. 3.6.5. □

Accordingly there is a $\text{Grp}(\mathbf{H})$ -valued automorphism group construction:

Definition 3.6.11. For $X \in \mathbf{H}$ and $E \in \mathbf{H}_{/X}$ we say that the \mathbf{H} -valued automorphism group of E is the dependent product, def 3.6.2,

$$\mathbf{Aut}_{\mathbf{H}}(E) := \prod_X \mathbf{Aut}(E)$$

of the automorphism group of E in $\mathbf{H}_{/X}$, def. 3.6.209.

Proposition 3.6.12. For $E \in \mathbf{H}_{/X}$ the object $\mathbf{Aut}_{\mathbf{H}}(E) \in \mathbf{H}$ of def. 3.6.11 sits in an ∞ -pullback diagram of the form

$$\begin{array}{ccc} \mathbf{Aut}_{\mathbf{H}}(E) & \longrightarrow & * \\ \downarrow & & \downarrow \vdash E \\ \mathbf{Aut}(X) & \xrightarrow{E \circ (-)} & \left[\sum_X E, X \right] \end{array} .$$

Proof. By prop. 3.6.10. □

More generally we have the following.

Proposition 3.6.13. *For \mathbf{H} an ∞ -topos and for $f : X \rightarrow Y$ a morphism in \mathbf{H} , the functor*

$$\sum_f := f \circ (-) : \mathbf{H}_{/X} \rightarrow \mathbf{H}_{/Y}$$

between the slices over the domain and codomain given by postcomposition with f is the extra left adjoint in an essential geometric morphism

$$\left(\sum_f \dashv f^* \dashv \prod_f \right) : \mathbf{H}_{/X} \begin{array}{c} \xrightarrow{\sum_f} \\ \xleftarrow{f^*} \\ \xrightarrow{\prod_f} \end{array} \mathbf{H} ,$$

called the base change geometric morphism. Here f^ is given by forming the ∞ -pullback in \mathbf{H} along f . As before \sum_f is called the dependent sum along f and \prod_f the dependent product along f .*

This is prop. 6.3.5.1, remark 6.3.5.10 of [L-Topos].

Proposition 3.6.14. *For \mathbf{H} an ∞ -topos, the ∞ -functor*

$$\mathbf{H}_{/(-)} : \mathbf{H} \rightarrow \infty\text{Topos}^{\text{et}}/\mathbf{H}$$

given by prop. 3.6.13, constitutes an equivalence of ∞ -categories between \mathbf{H} and the full sub- ∞ -category of the slice of ∞ -toposes and geometric morphisms over \mathbf{H} on the étale geometric morphisms.

This is [L-Topos], remark 6.3.5.10.

The internal hom in the slice is closely related to the dependent product:

Proposition 3.6.15. *For \mathbf{H} an ∞ -topos and $X \in \mathbf{H}$ an object, let $E_1, E_2 \in \mathbf{H}_{/X}$ be two object in the slice, corresponding to morphisms $E_i : \sum_X E_i \rightarrow X$ in \mathbf{H} . Then there is a natural equivalence*

$$[E_1, E_2] \simeq \prod_{f_1} f_1^* E_2 .$$

Proof. The product in the slice $\mathbf{H}_{/X}$ is given by the fiber product in \mathbf{H} over X . Hence for $E \in \mathbf{H}_{/X}$ the product functor is

$$(-) \times E \simeq \sum_f f^* .$$

Since the internal hom is right adjoint to this functor, the statement follows by the defining adjoint tripe $(\prod_f \dashv f^* \dashv \sum_f)$. □

Proposition 3.6.16. *For \mathbf{H} an ∞ -topos, $X \in \mathbf{H}$ an object and $E \in \mathbf{H}_{/X}$ a slice, the ∞ -fiber of the morphism p_X from def. 3.6.9 over the identity $* \xrightarrow{\text{id}_{\sum_X E}} [\sum_X E, \sum_X E]$ is $\Omega_E[\sum_X E, X]$: there is a fiber sequence of the form*

$$\Omega_E[\sum_X E, X] \hookrightarrow \prod_X [E, E] \xrightarrow{p_X} [\sum_X E, \sum_X E] .$$

Proof. This follows directly with prop. 3.6.10 and the pasting law, prop. 2.3.2.

More explicitly, by the proof of prop. 3.6.9 the morphism p_X is for any $U \in \mathbf{H}$ characterized, up to equivalence, as being the forgetful morphism

$$\mathbf{H}(U, p) : \mathbf{H}_{/X}(U \times E, E) \longrightarrow \mathbf{H}(U \times X, X)$$

that sends a morphism in the slice over X to the morphism obtained by forgetting the maps to X . Since $\mathbf{H}(U, -)$ preserves ∞ -limits, it is sufficient to show that the homotopy fiber of this morphism (in ∞Grpd) is $\mathbf{H}(U, \Omega_E[\sum_X E, X])$, naturally for each U . To that end, notice that $\mathbf{H}(U, p_X)$ is the middle vertical morphism in the following diagram, where the right square is the ∞ -pullback diagram that exhibits the hom space in the slice by prop. 3.6.5:

$$\begin{array}{ccccc} \mathbf{H}(U, \Omega_E[\sum_X E, X]) & \longrightarrow & \mathbf{H}_{/X}(U \times E, E) & \longrightarrow & * \\ \downarrow & & \downarrow \mathbf{H}(U, p_X) & & \downarrow \vdash_{U \times E} \\ * & \longrightarrow & \mathbf{H}(U \times \sum_X E, \sum_X E) & \xrightarrow{E \circ (-)} & \mathbf{H}(U \times \sum_X E, X) \end{array} .$$

With the left square now denoting the ∞ -pullback in question, we obtain the fiber in the top left by the pasting law for ∞ -pullbacks, which says that also the total rectangle here is an ∞ -pullback. But this total pullback rectangle is by example 3.6.111 the one that characterizes the loop space object and hence identifies the top left item in the above diagram as claimed. \square

3.6.1.2 Presentations We discuss presentations of slice ∞ -categories, def. 3.6.1, by simplicial model categories, remark 2.1.35.

Proposition 3.6.17. *For C a model category and $X \in C$ an object, the slice category (overcategory) $C_{/X}$ as well as the co-slice category (undercategory) $C^{X/}$ inherit model category structures whose fibrations, cofibrations and weak equivalences are precisely those of C under the canonical forgetful functors $C_{/X} \rightarrow C$ and $C^{X/} \rightarrow C$, respectively.*

Proposition 3.6.18. *If the model category C is*

- *cofibrantly generated;*
- *or proper;*
- *or cellular*

then so are the (co)-slice model structures of prop. 3.6.17, for every object $X \in C$.

This is shown in [H].

Proposition 3.6.19. *If the model category C is combinatorial, then so is the slice model structure $C_{/X}$, for every object $X \in C$.*

Proof. With prop. 3.6.18 this follows from the fact that the slice of a locally presentable category is again locally presentable, (e.g. remark 3 in [CRV]). \square

Proposition 3.6.20. *If C is a simplicial model category, then so is its slice $C_{/X}$, for every object $X \in C$.*

Proposition 3.6.21. *Let C be a simplicial model category and write \mathcal{C} for the ∞ -category that it presents. If X is fibrant in C , then the slice model structure $C_{/X}$ is a presentation of the ∞ -categorical slicing $\mathcal{C}_{/X}$. If X is cofibrant in C , then the co-slice model structure $C^{X/}$ is a presentation of the ∞ -categorical co-slicing $\mathcal{C}^{X/}$.*

Proof. We discuss the first case. The other one is dual. We need to check that the derived hom-spaces are the correct ∞ -categorical hom-spaces. Let $A \xrightarrow{a} X$ and $B \xrightarrow{b} X$ be two objects of $\mathcal{C}_{/X}$. By prop. 3.6.5 the hom $\mathcal{C}_{/X}(a, b)$ is the ∞ -pullback

$$\mathcal{C}_{/X}(a, b) \simeq \mathcal{C}(A, B) \times_{\mathcal{C}(A, X)} \{a\}$$

in ∞Grpd . Now write a for a cofibrant representative of this object in $\mathcal{C}_{/X}$ and b for a fibrant representative. The sSet -hom object in $\mathcal{C}_{/X}$ is the ordinary pullback

$$C_{/X}(a, b) \simeq C(A, B) \times_{C(A, X)} \{a\}$$

in sSet . One finds that a being cofibrant in $\mathcal{C}_{/X}$ means that A is cofibrant in C and b being fibrant in $\mathcal{C}_{/X}$ means that it is a fibration in C . Since by assumption X is fibrant in C , it follows that also B is fibrant in C . By the fact that $\text{sSet}_{\text{Quillen}}$ is itself a simplicial model category, it follows with prop. 2.1.38 that the simplicial hom-objects appearing in the above pullback are the correct hom-spaces, and that the pullback is along a fibration. Together this means by prop. 2.3.8 that the ordinary pullback is indeed a model for the above ∞ -pullback. \square

3.6.2 Truncated objects and Postnikov towers

We discuss general notions and presentations of truncated objects and Postnikov towers in an ∞ -topos.

3.6.2.1 General abstract

Definition 3.6.22. For $n \in \mathbb{N}$ an ∞ -groupoid $X \in \infty\text{Grpd}$ is called *n-truncated* or a *homotopy n-type* if all its homotopy groups in degree $> n$ are trivial. It is called *(-1)-truncated* if it is either empty or contractible. It is called *(-2)-truncated* if it is non-empty and contractible.

For \mathbf{H} an ∞ -topos, and object $A \in \mathbf{H}$ is called *n-truncated* for $-2 \leq n \leq \infty$ if for all $X \in \mathbf{H}$ the hom ∞ -groupoid $\mathbf{H}(X, A)$ is *n-truncated*.

An ∞ -functor between ∞ -groupoids is called *k-truncated* for $-2 \leq k \leq \infty$ if all its homotopy fibers are *k-truncated*. A morphism $f : A \rightarrow B$ in an ∞ -topos \mathbf{H} is *k-truncated* if for all objects $X \in \mathbf{H}$ the induced ∞ -functor $\mathbf{H}(X, f) : \mathbf{H}(X, A) \rightarrow \mathbf{H}(X, B)$ is *k-truncated*.

This appears as [Re05] 7.1 and [L-Topos] def. 5.5.6.8.

Remark 3.6.23. • A morphism is *(-2)-truncated* precisely if it is an equivalence.

- A morphism between ∞ -groupoids that is *(-1)-truncated* is a *full and faithful ∞ -functor*. A general morphism that is *(-1)-truncated* is an *∞ -monomorphism*.

Proposition 3.6.24. For all $(-2) \leq n \leq \infty$ the full sub- ∞ -category $\mathbf{H}_{\leq n}$ of \mathbf{H} on the *n-truncated* objects is reflective in \mathbf{H} in that the inclusion functor has a left adjoint ∞ -functor τ_n

$$\mathbf{H}_{\leq n} \begin{array}{c} \xleftarrow{\tau_n} \\ \xrightarrow{\quad} \end{array} \mathbf{H} .$$

Moreover, τ_n preserves finite products

This is [L-Topos] prop. 5.5.6.18, lemma 6.5.1.2.

Definition 3.6.25. For an object $X \in \mathbf{H}$ in an ∞ -topos, we say that the canonical sequence

$$\begin{array}{c} X \\ \swarrow \quad \searrow \\ \cdots \longrightarrow \tau_n X \longrightarrow \cdots \longrightarrow \tau_0 X \longrightarrow \tau_{-1} X \end{array}$$

induced from the reflectors of prop. 3.6.24 is the *Postnikov tower* of X .

We say that the Postnikov tower *converges* if the above diagram exhibits X as the ∞ -limit over its Postnikov tower

$$X \simeq \lim_{\leftarrow n} \tau_n X.$$

This is def. 5.5.6.23 in [L-Topos].

Remark 3.6.26. Postnikov towers are a special cases of towers of higher *images*. This we discuss further below in 3.6.3.

3.6.2.2 Presentations

Proposition 3.6.27. *Let C be a small site of definition of an ∞ -topos \mathbf{H} , so that*

$$\mathbf{H} \simeq L_W[C^{\text{op}}, \text{sSet}]_{\text{proj,loc}}$$

according to theorem 2.2.15. Let $[C^{\text{op}}, \text{sSet}]_{\text{proj,loc}, \leq n}$ be the left Bousfield localization of the local projective model structure on simplicial presheaves at the set of morphisms

$$\{\partial\Delta[k+1] \hookrightarrow U \rightarrow \Delta[k+1] \cdot U \mid U \in C; k > n\}.$$

This is a presentation of the sub- ∞ -category of n -truncated objects

$$\mathbf{H}_{\leq n} \simeq ([C^{\text{op}}, \text{sSet}]_{\text{proj,loc}, \leq n})^\circ$$

and the canonical Quillen adjunction

$$[C^{\text{op}}, \text{sSet}]_{\text{proj,loc}} \begin{array}{c} \xleftarrow{\text{id}} \\ \xrightarrow{\text{id}} \end{array} [C^{\text{op}}, \text{sSet}]_{\text{proj,loc}, \leq n}$$

presents the reflection, $\tau_n \simeq \mathbb{L}\text{id}$.

This appears in the proof of [Re05], prop. 7.5.

We now discuss an explicit presentation for n -truncation and Postnikov decompositions, def. 3.6.25, in terms of the projective model structure on simplicial presheaves. First recall the following classical notions, reviewed for instance in [GoJa99].

Definition 3.6.28. Let $\iota_{n+1} : \Delta_{\leq n+1} \hookrightarrow \Delta$ be the full subcategory of the simplex category on the objects $[k]$ for $k \leq n+1$. Write $\text{sSet}_{\leq n+1} := \text{Func}(\Delta_{\leq n+1}^{\text{op}}, \text{Set})$ for the category of $(n+1)$ -stage simplicial sets.

Finally, write

$$\mathbf{cosk}_{n+1} : \text{sSet} \xrightarrow{\iota_{n+1}^*} \text{sSet}_{\leq n+1} \xrightarrow{\mathbf{cosk}_{n+1}} \text{sSet}$$

for the composite of the pullback along ι_{n+1} with its *right adjoint* \mathbf{cosk}_{n+1} .

For $X \in \text{sSet}$ we say that $\mathbf{cosk}_{n+1}X$ is its $(n+1)$ -*coskeleton*.

All of these constructions prolong to simplicial presheaves.

Theorem 3.6.29. *For $X \in \text{sSet}$ a Kan complex, the tower of \mathbf{cosk} -units*

$$\cdots \rightarrow \mathbf{cosk}_3 X \rightarrow \mathbf{cosk}_2 X \rightarrow \mathbf{cosk}_1 X$$

presents the Postnikov decomposition of X in ∞Grpd .

This is a classical result due to [DwKa84b].

Proposition 3.6.30. *For C the site of definition of a hypercomplete ∞ -topos, let $X \in [C^{\text{op}}, \text{sSet}]_{\text{proj}, \text{loc}}$ be a fibrant simplicial presheaf. Then the tower of **cosk**-units*

$$\cdots \rightarrow \mathbf{cosk}_3 X \rightarrow \mathbf{cosk}_2 X \rightarrow \mathbf{cosk}_1 X$$

presents the Postnikov decomposition of X in $\text{Sh}_\infty(X)$.

Proof. It is sufficient to show that $X \rightarrow \mathbf{cosk}_{n+1} X$ presents the n -truncation $X \rightarrow \tau_n X$ in $\text{Sh}_\infty(X)$. For this, in turn, it is sufficient to observe that this morphism exhibits a fibrant resolution in $[C^{\text{op}}, \text{sSet}]_{\text{proj}, \text{loc}, \leq n}$. By standard facts about left Bousfield localizations, $\mathbf{cosk}_{n+1} X$ is indeed fibrant in that model structure, since it is fibrant in the original structure by assumption and is local with respect to higher sphere inclusions by the nature of the coskeleton construction.

So it remains to see that the morphism $X \rightarrow \mathbf{cosk}_{n+1} X$ is a weak equivalence in the localized model structure. We notice that by assumption of hypercompleteness, the homotopy category is also computed by the derived hom in the truncation-localization of the Jardine model structure [Jard87]. By the nature of **cosk**, the morphism induces an isomorphism on all homotopy sheaves in degree $\leq n$ (since the homotopy presheaves of X and $\mathbf{cosk}_{n+1} X$ in these degrees are manifestly equal and $X \rightarrow \mathbf{cosk}_{n+1} X$ is the identity on cells in these degrees). Since by prop. 3.6.27 also the localized Jardine structure presents the full sub- ∞ -category on n -truncated objects, the morphisms which are isos on homotopy groups in degree $\leq n$ are already equivalences here. \square

3.6.3 Epi-/mono-morphisms, images and relative Postnikov systems

In an ∞ -topos there is an infinite tower of notions of epimorphisms and monomorphisms: the $(n-2)$ -connected and $(n-2)$ -truncated morphisms for all $n \in \mathbb{N}$ [Re05, L-Topos]. Accordingly, factorization through these induces a notion of n -images of morphisms in an ∞ -topos, for each $n \in \mathbb{N}$. The case when $n = -1$ is in some sense the most direct generalization of the 1-categorical notion.

3.6.3.1 General abstract

Definition 3.6.31. For $f : X \rightarrow Y$ a morphism in an ∞ -topos \mathbf{H} and for $n \in \mathbb{N}$, the $(n-2)$ -connected/ $(n-2)$ -truncated factorization of f is the $(n-2)$ -truncation of f , def. 3.6.22, as an object in the slice $\mathbf{H}_{/Y}$, def. 3.6.1:

$$\begin{array}{ccc} X & \xrightarrow{\quad} & \sum_Y \tau_{n-2} f \\ & \searrow f & \swarrow \tau_{n-2} f \\ & & Y \end{array} .$$

We write

$$\text{im}_n(f) := \sum_Y \tau_{n-2} f$$

and call this the n -image of f . We also say that

$$\text{im}_\infty(f) := X$$

is the 1-image of f .

Definition 3.6.32. A morphism $f : X \rightarrow Y$ is called

- an n -epimorphism if its n -image injection $\text{im}_n(f) \rightarrow Y$ is an equivalence;
- an n -monomorphism if its n -image projection $X \rightarrow \text{im}_n(f)$ is an equivalence.

Proposition 3.6.33. *For all n , the classes $(\text{Epi}_n(\mathbf{H}), \text{Mono}_n(\mathbf{H}))$ constitute an orthogonal factorization system.*

This is Proposition 8.5 in [Re05] and Example 5.2.8.16 in [L-Topos].
Moreover:

Proposition 3.6.34. *The factorization systems of prop. 3.6.33 are stable: for all n , the class of n -monomorphisms is preserved by ∞ -pullback.*

This is [L-Topos], prop. 6.1.5.16(6).

Remark 3.6.35. By prop. 2.3.5 also 1-epimorphisms are preserved by ∞ -pullback (as are 0-epimorphisms = equivalences), but the class of n -epimorphisms for $n > 1$ is in general not preserved by ∞ -pullback.

Proposition 3.6.36. *A morphism $f : X \rightarrow Y$ is an n -monomorphism, precisely if its diagonal $X \rightarrow X \times_Y X$ is an $(n - 1)$ -monomorphism.*

This is [L-Topos], lemma 5.5.6.15.

Of particular interest are 1-epimorphisms/1-monomorphisms.

Definition 3.6.37. For $f : X \rightarrow Y$ a morphism in \mathbf{H} , we write its 1-epi/1-mono factorization given by Proposition 3.6.33 as

$$f : X \twoheadrightarrow \text{im}_1(f) \hookrightarrow Y$$

and we call $\text{im}_1(f) \hookrightarrow Y$ the *1-image* (or just *image*, for short) of f .

Equivalently the 1-image is the (-1) -truncation of $f : X \rightarrow Y$ regarded as an object in the slice ∞ -topos.

Definition 3.6.38. Let \mathbf{H} be an ∞ -topos. For $X \rightarrow Y$ any morphism in \mathbf{H} , there is a simplicial object $\check{C}(X \rightarrow Y)$ in \mathbf{H} (the *Čech nerve* of $f : X \rightarrow Y$) which in degree n is the $(n + 1)$ -fold ∞ -fiber product of X over Y with itself

$$\check{C}(X \rightarrow Y) : [n] \mapsto X \times_Y^{n+1}$$

A morphism $f : X \rightarrow Y$ in \mathbf{H} is an *effective epimorphism* if it is the colimiting cocone under its own Čech nerve:

$$f : X \rightarrow \varinjlim \check{C}(X \rightarrow Y).$$

Write $\text{Epi}(\mathbf{H}) \subset \mathbf{H}^I$ for the collection of effective epimorphisms.

Proposition 3.6.39. *A morphism $f : X \rightarrow Y$ in the ∞ -topos \mathbf{H} is an effective epimorphism precisely if its 0-truncation $\tau_0 f : \tau_0 X \rightarrow \tau_0 Y$ is an epimorphism (necessarily effective) in the 1-topos $\tau_{\leq 0} \mathbf{H}$.*

This is Proposition 7.2.1.14 in [L-Topos].

Proposition 3.6.40. *The effective epimorphisms of def. 3.6.38 are equivalently the 1-epimorphisms of def. 3.6.31. In particular, for $f : X \rightarrow Y$ any morphism, its 1-image, def. 3.6.37, is given by the ∞ -colimit over its Čech nerve, def. 3.6.38:*

$$\text{im}_1(f) \simeq \varinjlim_n \left(X \times_Y^{n+1} \right).$$

Proof. Let $f : X \twoheadrightarrow \text{im}_1(f) \twoheadrightarrow Y$ be the essentially unique 1-image factorization. Then by prop. 3.6.36 the diagram exhibiting the ∞ -fiber product of this morphism with itself decomposes into a pasting

diagram of ∞ -pullbacks of the form

$$\begin{array}{ccccc}
 X \times_Y X & \simeq & X \times_{\text{im}_1(f)} X & \longrightarrow & X & \xrightarrow{\simeq} & X \\
 & & \downarrow & & \downarrow & & \downarrow \\
 & & X & \longrightarrow & \text{im}_1(f) & \xrightarrow{\simeq} & \text{im}_1(f) \\
 & & \downarrow \simeq & & \downarrow \simeq & & \downarrow \simeq \\
 & & X & \longrightarrow & \text{im}_1(f) \hookrightarrow & \longrightarrow & Y \\
 & & & \searrow f & & & \uparrow f
 \end{array}$$

By the pasting law, prop. 2.3.2 this identifies the ∞ -fiber product of f with itself over Y with its product over $\text{im}_1(f)$, as indicated, and hence the Čech nerve of f is equivalently that of its image projection $X \longrightarrow \text{im}_1(f)$. Finally by the Giraud-Rezk-Lurie axiom, def. 2.2.2, satisfied by the ambient ∞ -topos, the ∞ -colimit over the Čech nerve of $X \longrightarrow \text{im}_1(f)$ is that morphism itself. \square

The following is a simple consequence which we will need.

Proposition 3.6.41. *For*

$$\iota : A \hookrightarrow B$$

a 1-monomorphism in \mathbf{H} and for $X \in \mathbf{H}$ any object, the image of ϕ under the internal hom $[X, -] : \mathbf{H} \rightarrow \mathbf{H}$ is again a 1-monomorphism.

$$[X, \iota] : [X, A] \hookrightarrow [X, B]$$

Proof. By prop. 3.6.36 a morphism is a 1-monomorphism precisely if the ∞ -fiber product with itself reproduces its domain. Since $[X, -]$ preserves ∞ -limits, this implies the claim. \square

Proposition 3.6.42. *For $\iota : X \hookrightarrow *$ a 1-monomorphism (exhibiting X as a subterminal object), and for $E_1, E_2 \in \mathbf{H}_{/X}$ two objects in the slice, the canonical map*

$$p_X : \prod_X [E_1, E_2] \rightarrow \left[\sum_X E_1, \sum_X E_2 \right]$$

of prop. 3.6.9 is an equivalence.

Proof. By the proof of prop. 3.6.9 it suffices to show that the analogous statement holds for the external hom, hence that we have that the canonical map

$$\mathbf{H}_{/X}(E_1, E_2) \longrightarrow \mathbf{H}\left(\sum_X E_1, \sum_X E_2\right)$$

of prop. 3.6.5 is an equivalence. That morphism sits in the ∞ -pullback on the left of the diagram

$$\begin{array}{ccc}
 \mathbf{H}_{/X}(E_1, E_2) & \longrightarrow & * \\
 \downarrow & & \downarrow \vdash_{E_1} \\
 \mathbf{H}\left(\sum_X E_1, \sum_X E_2\right) & \xrightarrow{E_2 \circ (-)} & \mathbf{H}\left(\sum_X E_1, X\right) \hookrightarrow * \\
 & & \mathbf{H}(X, \iota)
 \end{array}$$

in ∞Grpd . Here $\mathbf{H}(\sum_X E_1, X)$ is subterminal and inhabited, hence is terminal. Therefore the right vertical morphism is an equivalence and hence so is the left vertical morphism. \square

By taking \mathbf{H} in prop. 3.6.42 itself to be a slice of another ∞ -topos, the statement implies the following seemingly more general statement:

Proposition 3.6.43. *for $f : X \hookrightarrow Y$ a 1-monomorphism in an ∞ -topos \mathbf{H} and for $E_1, E_2 \in \mathbf{H}_{/X}$ two objects in the slice over X , the canonical morphism*

$$\prod_Y p_f : [E_1, E_2]_{\mathbf{H}} \rightarrow \left[\sum_f E_1, \sum_f E_2 \right]_{\mathbf{H}}$$

between the \mathbf{H} -valued slice homs of def. 3.6.6 is an equivalence.

The following is another simple fact that we will need.

Proposition 3.6.44. *For $f : X \rightarrow Y$ any morphism in \mathbf{H} its homotopy fiber over any global point of Y in the image of f is equivalent to the homotopy fiber over the corresponding point in $\text{im}_1(f)$.*

Proof. By the pasting law, prop. 2.3.2 the homotopy fiber sits in a pasting diagram of ∞ -pullbacks.

$$\begin{array}{ccc} \text{fib}_y(f) & \longrightarrow & X \\ \downarrow & & \downarrow \\ * & \xrightarrow{y} & \text{im}_1(f) \\ \downarrow & & \downarrow \\ * & \xrightarrow{y} & Y \end{array} .$$

That y is in the image of f precisely says that we have the bottom square and the fact that that the bottom right morphism is a 1-monomorphism says that the bottom square is an ∞ -pullback. This identifies the middle row of the digram as indicated. (For instance one can check this by applying $\mathbf{H}(U, -)$ to the diagram where U ranges over a set of generators and then using that the only subobjects in ∞Grpd of $* \simeq \mathbf{H}(U, *)$ are \emptyset and $*$ itself). \square

Now we turn to discussion of the *towers* of n -image factorizations as n ranges, which are the *relative Postnikov towers* in an ∞ -topos.

Remark 3.6.45. The n -images for all n form a tower

$$X \xrightarrow{=} \text{im}_\infty(f) \longrightarrow \cdots \longrightarrow \text{im}_2(f) \longrightarrow \text{im}_1(f) \longrightarrow \text{im}_0(f) \xrightarrow{\simeq} Y ,$$

f

also called the *relative Postnikov tower* of f . For $Y \simeq *$ the terminal object this is the (absolute) *Postnikov tower* of the object X . For $X \simeq *$ the terminal object, this is the *Whitehead tower* of Y . Conversely, the relative Postnikov tower of f in \mathbf{H} is equivalently the absolute Postnikov tower of f regarded as an object of the slice $\mathbf{H}_{/Y}$.

Remark 3.6.46. For $f : X \rightarrow *$ a terminal morphism, the n -image coincides with the $(n - 2)$ -truncation of X :

$$\tau_{n-2}X \simeq \text{im}_n(X \rightarrow *) .$$

Proposition 3.6.47. *Let $f : X \rightarrow Y$ be a morphism in an ∞ -topos \mathbf{H} and let $x : * \rightarrow X$ be a base point. Then for all $n \in \mathbb{N}$, forming n -images commutes with forming loop space objects up to a shift in image-degree, in that there is a natural equivalence*

$$\Omega(\mathrm{im}_n(f)) \simeq \mathrm{im}_{n-1}(\Omega f).$$

Proof. The corresponding statement in homotopy type theory is shown in [SpRi12]. The above statement is the categorical semantics of that. \square

3.6.3.2 Presentations We discuss presentations of n -images in ∞ -toposes by constructions on simplicial presheaves.

In $\mathbf{H} = \infty\mathrm{Grpd}$, the general notion of relative Postnikov towers, remark 3.6.45, reproduces the traditional one.

Definition 3.6.48. For $X, Y \in \mathrm{sSet}$ two simplicial sets, let $f : X \rightarrow Y$ be a Kan fibration. For $n \in \mathbb{N}$ define an equivalence relation \sim_n on X_\bullet by declaring that two k -simplices $\sigma_1, \sigma_2 : \Delta^k \rightarrow X$ of X are equivalent if

1. they have the same n -skeleton $\mathrm{sk}_n \Delta^k \longrightarrow \Delta^k \xrightarrow{\sigma_1, \sigma_2} X$
2. and $f(\sigma_1) = f(\sigma_2)$.

Write then

$$\mathrm{im}_{n+1}(f) := X / \sim_n$$

for the quotient simplicial set. This comes equipped with canonical morphisms of simplicial sets

$$X \begin{array}{c} \xrightarrow{\quad} \mathrm{im}_{n+1}(f) \xrightarrow{\quad} Y \\ \quad \quad \quad \curvearrowright \end{array} .$$

This appears for instance as def. VI 2.9 in [GoJa99].

Proposition 3.6.49. *Under the equivalence $\infty\mathrm{Grpd} \simeq L_{\mathrm{whe}}\mathrm{sSet}$, the construction of def. 3.6.48 is a presentation of the relative Postnikov tower, remark 3.6.45, in $\mathbf{H} = \infty\mathrm{Grpd}$.*

This is essentially the statement of theorem VI 2.11 in [GoJa99].

For maps between low truncated objects, we have the following simple identification of their n -images.

Proposition 3.6.50. *A 1-functor between 1-groupoids is n -truncated as a morphism of ∞ -groupoids precisely if*

- for $n = -2$ it is an equivalence of categories;
- for $n = -1$ it is a full and faithful functor;
- for $n = 0$ it is a faithful functor.

Proof. We consider the case $n = 0$. A functor $f : X \rightarrow Y$ between groupoids being faithful is equivalent to the induced morphisms on first homotopy groups being monomorphisms. Therefore for $F \rightarrow X \rightarrow Y$ the homotopy fiber over any point of Y , the long exact sequence of homotopy groups yields

$$\cdots \rightarrow \pi_1(F) \rightarrow \pi_1(X) \xrightarrow{f_*} \pi_1(Y) \rightarrow \cdots$$

and hence realizes $\pi_1(F)$ as the kernel of an injective map. Therefore $\pi(F) \simeq *$ and hence F is 0-truncated for every basepoint. This is the defining condition for f being 0-truncated. \square

Proposition 3.6.51. *Let C be a site and let $f : X \rightarrow Y$ be a morphism of presheaves of groupoids on C which, under the nerve, are fibrant objects in $[C^{\text{op}}, \text{sSet}]_{\text{proj,loc}}$. If f is objectwise a) an equivalence, b) full and faithful or c) faithful, then the morphism presented by f in $\mathbf{H} := \text{Sh}_\infty(X)$ is a) -2-truncated, b) (-1)-truncated, c) 0-truncated, respectively.*

Proof. We need to compute for every $A \in \mathbf{H}$ the homotopy fibers of $\mathbf{H}(A, f)$. Since by assumption X and Y are fibrant presentations, we may pick any cofibrant presentation of A and obtain this morphism as $[C^{\text{op}}, \text{sSet}](A, f)$. This is the nerve of a functor of groupoids which is a) an equivalence, b) full and faithful or c) faithful, respectively. The statement then follows with observation 3.6.50. \square

Proposition 3.6.52. *Let $f : X \rightarrow Y$ be a morphism between presheaves of groupoids that are fibrant as objects of $[C^{\text{op}}, \text{sSet}]_{\text{proj}}$, and such that f is objectwise an essentially surjective and full functor.*

Then f presents a 0-connected morphism in $\text{Sh}_\infty(C)$.

Proof. One checks that functors between 1-groupoids are 0-connected as morphisms in ∞Grpd precisely if they are essentially surjective and faithful.

The direction (eso+full) \Rightarrow 0-connected of this argument goes through objectwise. \square

More generally, we obtain a similarly simple and concrete presentation of n -image factorization of morphisms in the case that they are presented by homomorphisms of *strict* ∞ -groupoids, def. 2.2.32.

Proposition 3.6.53. *Let $f : X \rightarrow Y$ be a morphism in ∞Grpd which is in the essential image of the inclusion*

$$\text{Str}\infty\text{Grpd} \hookrightarrow \text{KanCplx} \rightarrow L_{\text{whes}}\text{Set} \simeq \infty\text{Grpd}$$

of a morphism strict ∞ -groupoids, given by an underlying morphism of globular sets $f_\bullet : X_\bullet, Y_\bullet$. Then for $n \in \mathbb{N}$ the n -image factorization def. 3.6.31 of f is presented under this inclusion by the strict ∞ -groupoid $\text{im}_n(f)$ whose underlying globular set is

$$(\text{im}_n(f))_k := \begin{cases} X_k & \forall k < n-1 \\ \text{im}(X_{n-1}) \subset Y_{n-1} & \forall k = n-1 \\ Y_k & \forall k \geq n \end{cases}$$

equipped with the evident composition operations induced from those on X_\bullet and Y_\bullet , and with the evident morphisms

$$X_\bullet \longrightarrow \text{im}_n(f)_\bullet \longrightarrow Y_\bullet,$$

the left one being the identity in degree $k < n-1$, the quotient projection in degree $n-1$ and f in degree $k \geq n$, and the right one being f in degree $k < n-1$, the image inclusion in degree $n-1$ and the identity in degree $k \geq n$.

Proof. The homotopy groups of a strict globular ∞ -groupoid in any degree k are simply given by the groups of k -automorphisms of the identity $(k-1)$ -morphism on a given baspoint modulo $(k+1)$ -morphisms (hence the homology of the corresponding crossed complex, def. 1.2.89 in that degree). Therefore it is clear from the construction of $\text{im}_n(f)$ above that $X \rightarrow \text{im}_n(f)$ is surjective on π_0 and an isomorphism on $\pi_{k < n-1}$, and that $\text{im}_n(f)$ is a monomorphism on π_{n-1} and an isomorphism on $\pi_{k \geq n}$. \square

Remark 3.6.54. For the case $Y = *$ the content of prop. 3.6.53 is discussed in [BFGM].

3.6.4 Compact objects

Traditionally there are two notions referred to as *compactness* of a space, which are closely related but subtly different.

1. On the one hand a space is called compact if regarded as an object of a certain *site* each of its covering families has a finite subfamily that is still covering.
2. On the other hand, an object in a category with colimits is called compact if the hom-functor out of that object commutes with all filtered colimits. Or more generally in the ∞ -category context: if the hom- ∞ -functor out of the objects commutes with all filtered ∞ -colimits (section 5.3 of [L-Topos]).

For instance in the site of topological spaces or of smooth manifolds, equipped with the usual open-cover coverage, the first definition reproduces the traditional definition of *compact topological space* and of *compact smooth manifold*, respectively. But the notion of compact object in the category of topological spaces in the sense of the second definition is not quite equivalent. For instance the two-element set equipped with the indiscrete topology is compact in the first sense, but not in the second.

The cause of this mismatch, as we will discuss in detail below, becomes clearer once we generalize beyond 1-category theory to ∞ -topos theory: in that context it is familiar that locality of morphisms out of an object X into an n -truncated object A (an n -stack) is no longer controlled by just the notion of *covers* of X , but by the notion of *hypercover of height n* , which reduces to the ordinary notion of cover for $n = 0$. Accordingly it is clear that the ordinary condition on a compact topological space to admit finite refinement of any cover is just the first step in a tower of conditions: we may say an object is *compact of height n* if every hypercover of height n over the object is refined by a “finite hypercover” in a suitable sense.

Indeed, the condition on a *compact object* in a 1-category to distribute over filtered colimits turns out to be a compactness condition of *height 1*, which conceptually explains why it is stronger than the existence of finite refinements of covers. This state of affairs in the first two height levels has been known, in different terms, in topos theory, where one distinguishes between a topos being *compact* and being *strongly compact* [MoVe00]:

Definition 3.6.55. A 1-topos $(\Delta \dashv \Gamma) : \mathcal{X} \rightleftarrows \mathbf{Set}$ is called

1. a *compact topos* if the global section functor Γ preserves filtered colimits of subterminal objects (= (-1) -truncated objects);
2. a *strongly compact topos* if Γ preserves all filtered colimits (hence of all 0-truncated objects).

Clearly these are the first two stages in a tower of notions which continues as follows.

Definition 3.6.56. For $(-1) \leq n \leq \infty$, an ∞ -topos $(\Delta \dashv \Gamma) : \mathcal{X} \rightleftarrows \infty\mathbf{Grpd}$ is called *compact of height n* if Γ preserves filtered ∞ -colimits of n -truncated objects.

Since therefore the traditional terminology concerning “compactness” is not quite consistent across fields, with the category-theoretic “compact object” corresponding, as shown below, to the topos theoretic “strongly compact”, we introduce for definiteness the following terminology.

Definition 3.6.57. For C a subcanonical site, call an object $X \in C \hookrightarrow \mathbf{Sh}(C) \hookrightarrow \mathbf{Sh}_\infty(C)$ *representably compact* if every covering family $\{U_\alpha \rightarrow X\}_{i \in I}$ has a finite subfamily $\{U_j \rightarrow X\}_{j \in J \subset I}$ which is still covering.

The relation to the traditional notion of compact spaces and compact objects is given by the following

Proposition 3.6.58. *Let \mathbf{H} be a 1-topos and $X \in \mathbf{H}$ an object. Then*

1. *if X is representably compact, def. 3.6.57, with respect to the canonical topology, then the slice topos $\mathbf{H}_{/X}$, def. 3.6.1 is a compact topos;*

2. the slice topos \mathbf{H}/X is strongly compact precisely if X is a compact object.

Proof. Use that the global section functor Γ on the slice topos is given by

$$\Gamma([E \rightarrow X]) = \mathbf{H}(X, E) \times_{\mathbf{H}(X, X)} \{\mathrm{id}_X\}$$

and that colimits in the slice are computed as colimits in \mathbf{H} :

$$\lim_{\rightarrow_i} [E_i \rightarrow X] \simeq [(\lim_{\rightarrow_i} E_i) \rightarrow X].$$

For the first statement, observe that the subterminal objects of \mathbf{H}/X are the monomorphisms in \mathbf{H} . Therefore Γ sends all subterminals to the empty set except the terminal object itself, which is sent to the singleton set. Accordingly, if $U_\bullet : I \rightarrow \mathbf{H}/X$ is a filtered colimit of subterminals then

- either the $\{U_\alpha\}$ do not cover, hence in particular none of the U_α is X itself, and hence both $\Gamma(\lim_{\rightarrow_i} U_\alpha)$ as well as $\lim_{\rightarrow_i} \Gamma(U_\alpha)$ are the empty set;
- or the $\{U_\alpha\}_{i \in I}$ do cover. Then by assumption on X there is a finite subcover $J \subset I$, and then by assumption that U_\bullet is filtered the cover contains the finite union $\lim_{i \in J} U_\alpha = X$ and hence both $\Gamma(\lim_{\rightarrow_i} U_\alpha)$ as well as $\lim_{\rightarrow_i} \Gamma(U_\alpha)$ are the singleton set.

For the second statement, assume first that X is a compact object. Then using that colimits in a topos are preserved by pullbacks, it follows for all filtered diagrams $[E_\bullet \rightarrow X]$ in \mathbf{H}/X that

$$\begin{aligned} \Gamma(\lim_{\rightarrow_i} [E_i \rightarrow X]) &\simeq \mathbf{H}(X, \lim_{\rightarrow_i} E_i) \times_{\mathbf{H}(X, X)} \{\mathrm{id}\} \\ &\simeq (\lim_{\rightarrow_i} \mathbf{H}(X, E_i)) \times_{\mathbf{H}(X, X)} \{\mathrm{id}\} \\ &\simeq \lim_{\rightarrow_i} (\mathbf{H}(X, E_i) \times_{\mathbf{H}(X, X)} \{\mathrm{id}\})', \\ &\simeq \lim_{\rightarrow_i} \Gamma[E_i \rightarrow X] \end{aligned}$$

and hence \mathbf{H}/X is strongly compact.

Conversely, assume that \mathbf{H}/X is strongly compact. Observe that for every object $F \in \mathbf{H}$ we have a natural isomorphism $\mathbf{H}(X, F) \simeq \Gamma([X \times F \rightarrow X])$. Using this, we obtain for every filtered diagram F_\bullet in \mathbf{H} that

$$\begin{aligned} \mathbf{H}(X, \lim_{\rightarrow_i} F_i) &\simeq \Gamma([X \times (\lim_{\rightarrow_i} F_i) \rightarrow X]) \\ &\simeq \Gamma(\lim_{\rightarrow_i} [X \times F_i \rightarrow X]) \\ &\simeq \lim_{\rightarrow_i} \Gamma([X \times F_i \rightarrow X]) \\ &\simeq \lim_{\rightarrow_i} \mathbf{H}(X, F_i) \end{aligned}$$

and hence X is a compact object. □

Notice that a diagram of subterminal objects necessarily consists only of monomorphisms. We show now that a representably compact object generally distributes over such *monofiltered colimits*.

Definition 3.6.59. Call a filtered diagram $A : I \rightarrow D$ in a category D *mono-filtered* if for all morphisms $i_1 \rightarrow i_2$ in the diagram category I the morphism $A(i_1 \rightarrow i_2)$ is a monomorphism in D .

Lemma 3.6.60. For C a site and $A : I \rightarrow \mathrm{Sh}(C) \hookrightarrow \mathrm{PSh}(C)$ a monofiltered diagram of sheaves, its colimit $\lim_{\rightarrow_i} A_i \in \mathrm{PSh}(C)$ is a separated presheaf.

Proof. For $\{U_\alpha \rightarrow X\}$ any covering family in C with $S(\{U_\alpha\}) \in \text{PSh}(C)$ the corresponding sieve, we need to show that

$$\lim_{\rightarrow i} A_i(X) \rightarrow \text{PSh}_C(S(\{U_\alpha\}), \lim_{\rightarrow i} A_i)$$

is a monomorphism. An element on the left is represented by a pair $(i \in I, a \in A_i(X))$. Given any other such element, we may assume by filteredness that they are both represented over the same index i . So let (i, a) and (i, a') be two such elements. Under the above function, (i, a) is mapped to the collection $\{i, a|_{U_\alpha}\}_\alpha$ and (i, a') to $\{i, a'|_{U_\alpha}\}_\alpha$. If a is different from a' , then these families differ at stage i , hence at least one pair $a|_{U_\alpha}, a'|_{U_\alpha}$ is different at stage i . Then by mono-filteredness, this pair differs also at all later stages, hence the corresponding families $\{U_\alpha \rightarrow \lim_{\rightarrow i} A_i\}_\alpha$ differ. \square

Proposition 3.6.61. *For $X \in C \hookrightarrow \text{Sh}(C)$ a representably compact object, def. 3.6.57, $\text{Hom}_{\text{Sh}(C)}(X, -)$ commutes with all mono-filtered colimits.*

Proof. Let $A : I \rightarrow \text{Sh}(C) \hookrightarrow \text{PSh}(C)$ be a mono-filtered diagram of sheaves, regarded as a diagram of presheaves. Write $\lim_{\rightarrow i} A_i$ for its colimit. So with $L : \text{PSh}(C) \rightarrow \text{Sh}(C)$ denoting sheafification, $L \lim_{\rightarrow i} A_i$ is the colimit of sheaves in question. By the Yoneda lemma and since colimits of presheaves are computed objectwise, it is sufficient to show that for X a representably compact object, the value of the sheafified colimit is the colimit of the values of the sheaves on X

$$(L \lim_{\rightarrow i} A_i)(X) \simeq (\lim_{\rightarrow i} A_i)(X) = \lim_{\rightarrow i} A_i(X).$$

To see this, we evaluate the sheafification by the plus construction. By lemma 3.6.60, the presheaf $\lim_{\rightarrow i} A_i$ is already separated, so we obtain its sheafification by applying the plus-construction just *once*.

We observe now that *over a representably compact object X* the single plus-construction acts as the identity on the presheaf $\lim_{\rightarrow i} A_i$. Namely the single plus-construction over X takes the colimit of the value of the presheaf on sieves

$$S(\{U_\alpha\}) := \lim_{\rightarrow} (\coprod_{\alpha, \beta} U_{\alpha, \beta} \rightrightarrows \coprod_{\alpha} U_{\alpha})$$

over the opposite of the category of covers $\{U_\alpha \rightarrow X\}$ of X . By the very definition of compactness, the inclusion of (the opposite category of) the category of finite covers of X into that of all covers is a final functor. Therefore we may compute the plus-construction over X by the colimit over just the collection of finite covers. On a finite cover we have

$$\begin{aligned} \text{PSh}(S(\{U_\alpha\}), \lim_{\rightarrow i} A_i) &:= \text{PSh}(\lim_{\rightarrow} (\coprod_{\alpha, \beta} U_{\alpha, \beta} \rightrightarrows \coprod_{\alpha} U_{\alpha}), \lim_{\rightarrow i} A_i) \\ &\simeq \lim_{\leftarrow} (\prod_{\alpha} \lim_{\rightarrow i} A_i(U_\alpha) \rightrightarrows \prod_{\alpha, \beta} \lim_{\rightarrow i} A_i(U_{\alpha, \beta})) \\ &\simeq \lim_{\rightarrow i} \lim_{\leftarrow} (\prod_{\alpha} A_i(U_\alpha) \rightrightarrows \prod_{\alpha, \beta} A_i(U_{\alpha, \beta})) \\ &\simeq \lim_{\rightarrow i} A_i(X) \end{aligned}$$

where in the second but last step we used that filtered colimits commute with finite limits, and in the last step we used that each A_i is a sheaf.

So in conclusion, for X a representably compact object and $A : I \rightarrow \text{Sh}(C)$ a monofiltered diagram, we have found that

$$\begin{aligned} \text{Hom}_{\text{Sh}(C)}(X, L \lim_{\rightarrow i} A_i) &\simeq (\lim_{\rightarrow i} A_i)^+(X) \\ &\simeq \lim_{\rightarrow i} A_i(X) \\ &\simeq \lim_{\rightarrow i} \text{Hom}_{\text{Sh}(C)}(X, A_i) \end{aligned}$$

□

The discussion so far suggests that there should be conditions for “representably higher compactness” on objects in a site that imply that the Yoneda-embedding of these objects into the ∞ -topos over the site distribute over larger classes of filtered ∞ -colimits.

Definition 3.6.62. For C a site, say that an object $X \in C$ is *representably paracompact* if each bounded hypercover over X can be refined by the Čech nerve of an ordinary cover.

The motivating example is

Proposition 3.6.63. *Over a paracompact topological space, every bounded hypercover is refined by the Čech nerve of an ordinary open cover.*

Proof. Let $Y \rightarrow X$ be a bounded hypercover. By lemma 7.2.3.5 in [L-Topos] we may find for each $k \in \mathbb{N}$ a refinement of the cover given by Y_0 such that the non-trivial $(k + 1)$ -fold intersections of this cover factor through Y_{k+1} . Let then $n \in \mathbb{N}$ be a bound for the height of Y and form the intersection of the covers obtained by this lemma for $0 \leq k \leq n$. Then the resulting Čech nerve projection factors through $Y \rightarrow X$. □

Proposition 3.6.64. *Let $X \in C \hookrightarrow \text{Sh}_\infty(C) =: \mathbf{H}$ be an object which is*

1. *representably paracompact, def. 3.6.62;*
2. *representably compact, def. 3.6.57*

then it distributes over sequential ∞ -colimits $A_\bullet : I \rightarrow \text{Sh}_\infty(C)$ of n -truncated objects for every $n \in \mathbb{N}$.

Proof. Let $A_\bullet : I \rightarrow [C^{\text{op}}, \text{sSet}]$ be a presentation of a given sequential diagram in $\text{Sh}_\infty(\text{Mfd})$, such that it is fibrant and cofibrant in $[I, [C^{\text{op}}, \text{sSet}]_{\text{proj,loc}}]_{\text{proj}}$. Note for later use that this implies in particular that

- The ordinary colimit $\lim_{\rightarrow_i} A_i \in [C^{\text{op}}, \text{sSet}]$ is a homotopy colimit.
- Every A_i is fibrant in $[C^{\text{op}}, \text{sSet}]_{\text{proj,loc}}$ and hence also in $[C^{\text{op}}, \text{sSet}]_{\text{proj}}$.
- Every morphism $A_i \rightarrow A_j$ is (by example 2.3.16) a cofibration in $[C^{\text{op}}, \text{sSet}]_{\text{proj,loc}}$, hence in $[C^{\text{op}}, \text{sSet}]_{\text{proj}}$, hence in particular in $[C^{\text{op}}, \text{sSet}]_{\text{inj}}$, hence is over each $U \in C$ a monomorphism.

Observe that $\lim_{\rightarrow_i} A_i$ is still fibrant in $[C^{\text{op}}, \text{sSet}]_{\text{proj}}$: since the colimit is taken in presheaves, it is computed objectwise, and since it is filtered, we may find the lift against horn inclusions (which are inclusions of degreewise finite simplicial sets) at some stage in the colimit, where it exists by assumption that A_\bullet is projectively fibrant, so that each A_i is projectively fibrant in the local and hence in particular in the global model structure.

Since X , being representable, is cofibrant in $[C^{\text{op}}, \text{sSet}]_{\text{proj,loc}}$, it also follows by this reasoning that the diagram

$$\mathbf{H}(X, A_\bullet) : I \rightarrow \infty\text{Grpd}$$

is presented by

$$A_\bullet(X) : I \rightarrow \text{sSet}.$$

Since the functors

$$[I, [C^{\text{op}}, \text{sSet}]_{\text{proj,loc}}]_{\text{proj}} \xrightarrow{\text{id}} [I, [C^{\text{op}}, \text{sSet}]_{\text{proj}}]_{\text{proj}} \xrightarrow{\text{id}} [I, [C^{\text{op}}, \text{sSet}]_{\text{inj}}]_{\text{proj}} \xrightarrow{\text{id}} [I, \text{sSet}_{\text{Quillen}}]_{\text{proj}}$$

all preserve cofibrant objects, it follows that $A_\bullet(X)$ is cofibrant in $[I, \text{sSet}_{\text{Quillen}}]_{\text{proj}}$. Therefore also its ordinary colimit presents the corresponding ∞ -colimit.

This means that the equivalence which we have to establish can be written in the form

$$\mathbb{R}\mathrm{Hom}(X, \lim_{\rightarrow_i} A_i) \simeq \lim_{\rightarrow_i} A_i(X).$$

If here $\lim_{\rightarrow_i} A_i$ were fibrant in $[C^{\mathrm{op}}, \mathrm{sSet}]_{\mathrm{proj}, \mathrm{loc}}$, then the derived hom on the left would be given by the simplicial mapping space and the equivalence would hold trivially. So the remaining issue is now to deal with the fibrant replacement: the ∞ -sheafification of $\lim_{\rightarrow_i} A_i$.

We want to appeal to theorem 7.6 c) in [DHS04] to compute the derived hom into this ∞ -stackification by a colimit over hypercovers of the ordinary simplicial homs out of these hypercovers into $\lim_{\rightarrow_i} A_i$ itself. To do so, we now argue that by the assumptions on X , we may in fact replace the hypercovers here with finite Čech covers.

So consider the colimit

$$\lim_{\{U_\alpha \rightarrow X\}_{\mathrm{finite}}} [C^{\mathrm{op}}, \mathrm{sSet}](\check{C}(\{U_\alpha\}), \lim_{\rightarrow_i} A_i)$$

over all finite covers of X . Since by representable compactness of X these are cofinal in all covers of X , this is isomorphic to the colimit over all Čech covers

$$\dots = \lim_{\{U_\alpha \rightarrow X\}} [C^{\mathrm{op}}, \mathrm{sSet}](\check{C}(\{U_\alpha\}), \lim_{\rightarrow_i} A_i).$$

Next, by representable paracompactness of X , the Čech covers in turn are cofinal in all bounded hypercovers $Y \rightarrow X$, so that, furthermore, this is isomorphic to the colimit over all bounded hypercovers

$$\dots = \lim_{Y \rightarrow X} [C^{\mathrm{op}}, \mathrm{sSet}](Y, \lim_{\rightarrow_i} A_i).$$

Finally, by the assumption that the A_i are n -truncated, the colimit here may equivalently be taken over all hypercovers.

We now claim that the canonical morphism

$$\lim_{\{U_\alpha \rightarrow X\}_{\mathrm{finite}}} [C^{\mathrm{op}}, \mathrm{sSet}](\check{C}(\{U_\alpha\}), \lim_{\rightarrow_i} A_i) \rightarrow \mathbb{R}\mathrm{Hom}(X, \lim_{\rightarrow_i} A_i)$$

is a weak equivalence. Since the category of covers is filtered, we may first compute homotopy groups and then take the colimit. With the above isomorphisms, the statement is then given by theorem 7.6 c) in [DHS04].

Now to conclude: since maps out of the finite Čech nerves pass through the filtered colimit, we have

$$\begin{aligned} \mathbb{R}\mathrm{Hom}(X, \lim_{\rightarrow_i} A_i) &\simeq \lim_{\{U_\alpha \rightarrow X\}_{\mathrm{finite}}} [C^{\mathrm{op}}, \mathrm{sSet}](\check{C}(\{U_\alpha\}), \lim_{\rightarrow_i} A_i) \\ &\simeq \lim_{\{U_\alpha \rightarrow X\}_{\mathrm{finite}}} \lim_{\rightarrow_i} [C^{\mathrm{op}}, \mathrm{sSet}](\check{C}(\{U_\alpha\}), A_i) \\ &\simeq \lim_{\rightarrow_i} \lim_{\{U_\alpha \rightarrow X\}_{\mathrm{finite}}} [C^{\mathrm{op}}, \mathrm{sSet}](\check{C}(\{U_\alpha\}), A_i) \\ &\simeq \lim_{\rightarrow_i} A_i(X) \end{aligned}$$

Here in the last step we used that each single A_i is fibrant in $[C^{\mathrm{op}}, \mathrm{sSet}]_{\mathrm{proj}, \mathrm{loc}}$, so that for each $i \in I$

$$[C^{\mathrm{op}}, \mathrm{sSet}](X, A_i) \rightarrow [C^{\mathrm{op}}, \mathrm{sSet}](\check{C}(\{U_\alpha\}), A_i)$$

is a weak equivalence. Moreover, the diagram $[C^{\mathrm{op}}, \mathrm{sSet}](\check{C}(\{U_\alpha\}), A_\bullet)$ in sSet is still projectively cofibrant, by example 2.3.16, since all morphisms are cofibrations in $\mathrm{sSet}_{\mathrm{Quillen}}$, and so the colimit in the second but last line is still a homotopy colimit and thus preserves these weak equivalences. \square

3.6.5 Homotopy

3.6.5.1 General abstract

Definition 3.6.65. Let \mathbf{H} an ∞ -topos and $X \in \mathbf{H}$ an object. For $n \in \mathbb{N}$ write

$$(X^{(* \rightarrow \partial \Delta^{[n+1]})} : X^{\Delta^{[n]}} \rightarrow X) \in \mathbf{H}/X$$

for the cotensoring of X by the point inclusion into the simplicial n -sphere, regarded as an object in the slice of \mathbf{H} over X , def. 3.6.1. The n th homotopy group of X is the image of this under 0-truncation, prop. 3.6.24

$$\pi_n(X) := \tau_0(X^{* \rightarrow \partial \Delta^{[n+1]}}) \in \tau_0(\mathbf{H}/X).$$

This appears as def. 6.5.1.1 in [L-Topos].

Remark 3.6.66. Since truncation preserves finite products by prop. 3.6.24 we have that $\pi_n(X)$ is indeed a group object in the 1-topos $\tau_0()$ for $n \geq 1$ and is an abelian group object for $n \geq 2$.

Remark 3.6.67. For $\mathbf{H} = \infty\text{Grpd} \simeq \text{Top}$ and $x : * \rightarrow X \in \infty\text{Grpd}$ a pointed object, we have for all $n \in \mathbb{N}$ that

$$\pi_n(X, x) := x^* \pi_n(X) \in \tau_0 \infty\text{Grpd}/_* \simeq \text{Set}$$

is the n th homotopy group of X at x as traditionally defined.

In [L-Topos] this is remark 6.5.1.6.

3.6.5.2 Presentations (...)

3.6.6 Connected objects

We discuss objects in an ∞ -topos which are connected or higher connected in that their first non-trivial homotopy group, 3.6.5, is in some positive degree.

In a local ∞ -topos and hence in particular in a cohesive ∞ -topos, these are precisely the *deloopings of group objects*, discussed below in 3.6.8. In a more general ∞ -topos, such as a slice of a cohesive ∞ -topos, these are the (nonabelian/Giraud-)gerbes, discussed below in 3.6.15.

3.6.6.1 General abstract

Definition 3.6.68. Let $n \in \mathbb{Z}$, with $-1 \leq n$. An object $X \in \mathbf{H}$ is called *n -connected* if

1. the terminal morphism $X \rightarrow *$ is an effective epimorphism, def. 2.3.3;
2. all categorical homotopy groups $\pi_k(X)$, def. 3.6.65, for $k \leq n$ are trivial.

One also says

- *inhabited* or *well-supported* for (-1)-connected;
- *connected* for 0-connected;
- *simply connected* for 1-connected;
- *($n + 1$)-connective* for n -connected.

A morphism $f : X \rightarrow Y$ in \mathbf{H} is called *n -connected* if it is n -connected regarded as an object of \mathbf{H}/Y .

This is def. 6.5.1.10 in [L-Topos].

Example 3.6.69. An object $X \in \infty\text{Grpd} \simeq \text{Top}$ is n -connected precisely if it is n -connected in the traditional sense of higher connectedness of topological spaces. (A morphism in ∞Grpd is effective epi precisely if it induces an epimorphism on sets of connected components.)

Example 3.6.70. For C an ∞ -site, a connected object in $\text{Sh}_\infty(C)$ may also be called an (“nonabelian” or “Giraud”-) ∞ -gerbe over C . This we discuss below in 3.6.15.

Definition 3.6.71. An ∞ -topos \mathbf{H} has *homotopy dimension* $n \in \mathbb{N}$ if n is the smallest number such that every $(n - 1)$ -connected object $X \in \mathbf{H}$ admits a morphism $* \rightarrow X$ from the terminal object

Remark 3.6.72. A morphism $* \rightarrow X$ is a *section* of the terminal geometric morphism. So in an ∞ -topos of homotopy dimension n every $(n - 1)$ -connected object X has a section. For such X the terminal geometric morphism is therefore in fact a *split epimorphism*.

Example 3.6.73. The trivial ∞ -topos $\mathbf{H} = *$ is, up to equivalence, the unique ∞ -topos of homotopy dimension 0.

This is example 7.2.1.2 in [L-Topos].

Proposition 3.6.74. An ∞ -topos \mathbf{H} has homotopy dimension $\leq n$ precisely if the global section geometric morphism $\Gamma : \mathbf{H} \rightarrow \infty\text{Grpd}$, def. 2.2.4, sends $(n - 1)$ -connected morphisms to (-1) -connected morphisms (effective epimorphisms).

Proof. This is essentially lemma 7.2.1.7 in [L-Topos]. The proof there shows a bit more, even. □

Proposition 3.6.75. A local ∞ -topos, def. 3.2.1, has homotopy dimension 0.

Proof. By prop. 3.6.74 it is sufficient to show that effective epimorphisms are sent to effective epimorphisms. Since for a local ∞ -topos the global section functor is a left adjoint, it preserves not only the ∞ -limits involved in the characterization of effective epimorphisms, def. 2.3.3, but also the ∞ -colimits. □

Remark 3.6.76. In particular an ∞ -presheaf ∞ -topos over an ∞ -site with a terminal object is local. For this special case the statement of prop. 3.6.75 is example. 7.2.1.2 in [L-Topos], the argument above being effectively the same as the one given there.

Corollary 3.6.77. A cohesive ∞ -topos, def. 3.4.1, has homotopy dimension 0.

Proof. By definition, a cohesive ∞ -topos is in particular a local ∞ -topos. □

In an ordinary topos every morphism has a unique factorization into an epimorphism followed by a monomorphism, the *image factorization*.

$$\begin{array}{ccc} X & \xrightarrow{f} & A \\ & \searrow \text{epi} & \nearrow \text{mono} \\ & \text{im}(f) & \end{array}$$

In an ∞ -topos this notion generalizes to a tower of factorizations.

Proposition 3.6.78. In an ∞ -topos \mathbf{H} for any $-2 \leq k \leq \infty$, every morphism $f : X \rightarrow Y$ admits a factorization

$$\begin{array}{ccc} X & \xrightarrow{f} & A \\ & \searrow & \nearrow \\ & \text{im}_{k+1}(f) & \end{array}$$

into a k -connected morphism, def. 3.6.68 followed by a k -truncated morphism, def. 3.6.22, and the space of choices of such factorizations is contractible.

This is [L-Topos], example 5.2.8.18.

Remark 3.6.79. For $k = -1$ this is the immediate generalization of the (epi,mono) factorization system in ordinary toposes. In particular, the 0-image factorization of a morphism between 0-truncated objects is the ordinary image factorization.

For $k = 1$ this is the generalization of the (essentially surjective and full, faithful) factorization system for functors between groupoids.

3.6.6.2 Presentations We discuss presentations of connected and *pointed* connected objects in an ∞ -topos by presheaves of pointed or reduced simplicial sets.

Observation 3.6.80. Under the presentation $\infty\text{Grpd} \simeq (\text{sSet}_{\text{Quillen}})^\circ$, a Kan complex $X \in \text{sSet}$ presents an n -connected ∞ -groupoid precisely if

1. X is inhabited (not empty);
2. all simplicial homotopy groups of X in degree $k \leq n$ are trivial.

Definition 3.6.81. For $n \in \mathbb{N}$ a simplicial set $X \in \text{sSet}$ is *n -reduced* if it has a single k -simplex for all $k \leq n$, hence if its n -skeleton is the point

$$\text{sk}_n X = *.$$

For *0-reduced* we also just say *reduced*. Write

$$\text{sSet}_n \hookrightarrow \text{sSet}$$

for the full subcategory of n -reduced simplicial sets.

Proposition 3.6.82. *The n -reduced simplicial sets form a reflective subcategory*

$$\text{sSet}_n \xleftarrow{\text{red}_n} \text{sSet}$$

of that of simplicial sets, where the reflector red_n identifies all the n -vertices of a given simplicial set, in other words $\text{red}_n(X) = X/\text{sk}_n X$ for X a simplicial set.

The inclusion $\text{sSet}_n \hookrightarrow \text{sSet}$ uniquely factors through the forgetful functor $\text{sSet}^{*/} \rightarrow \text{sSet}$ from pointed simplicial sets, and that factorization is co-reflective

$$\text{sSet}_n \xleftarrow{E_{n+1}} \text{sSet}^{*/}.$$

Here the coreflector E_{n+1} sends a pointed simplicial set $* \xrightarrow{x} X$ to the sub-object $E_{n+1}(X, x)$ – the $(n+1)$ -Eilenberg subcomplex (e.g. def. 8.3 in [May67]) – of cells whose n -faces coincide with the base point, hence to the fiber

$$\begin{array}{ccc} E_{n+1}(X, x) & \longrightarrow & X \\ \downarrow & & \downarrow \\ \{*\} & \longrightarrow & \text{cosk}_n X \end{array}$$

of the projection to the n -coskeleton.

For $(* \rightarrow X) \in \text{sSet}^{*/}$ such that $X \in \text{sSet}$ is Kan fibrant and n -connected, the counit $E_{n+1}(X, *) \rightarrow X$ is a homotopy equivalence.

The last statement appears for instance as part of theorem 8.4 in [May67].

Proposition 3.6.83. *Let C be a site with a terminal object and let $\mathbf{H} := \text{Sh}_\infty(C)$. Then under the presentation $\mathbf{H} \simeq ([C^{\text{op}}, \text{sSet}]_{\text{proj,loc}})^\circ$ every pointed n -connected object in \mathbf{H} is presented by a presheaf of n -reduced simplicial sets, under the canonical inclusion $[C^{\text{op}}, \text{sSet}_n] \hookrightarrow [C^{\text{op}}, \text{sSet}]$.*

Proof. Let $X \in [C^{\text{op}}, \text{sSet}]$ be a simplicial presheaf presenting the given object. Then its objectwise Kan fibrant replacement $\text{Ex}^\infty X$ is still a presentation, fibrant in the global projective model structure. Since the terminal object in \mathbf{H} is presented by the terminal simplicial presheaf and since by assumption on C this is representable and hence cofibrant in the projective model structure, the point inclusion is presented by a morphism of simplicial presheaves $* \rightarrow \text{Ex}^\infty X$, hence by a presheaf of pointed simplicial sets $(* \rightarrow \text{Ex}^\infty X) \in [C^{\text{op}}, \text{sSet}^{*/}]$. So with observation 3.6.82 we obtain the presheaf of n -reduced simplicial sets

$$E_{n+1}(\text{Ex}^\infty X, *) \in [C^{\text{op}}, \text{sSet}_n] \hookrightarrow [C^{\text{op}}, \text{sSet}]$$

and the inclusion $E_{n+1}(\text{Ex}^\infty X, *) \rightarrow \text{Ex}^\infty X$ is a global weak equivalence, hence a local weak equivalence, hence exhibits $E_{n+1}(\text{Ex}^\infty X, *)$ as another presentation of the object in question. \square

Proposition 3.6.84. *The category sSet_0 of reduced simplicial sets carries a left proper combinatorial model category structure whose weak equivalences and cofibrations are those in $\text{sSet}_{\text{Quillen}}$ under the inclusion $\text{sSet}_0 \hookrightarrow \text{sSet}$.*

Proof. The existence of the model structure itself is prop. V.6.2 in [GoJa99]. That this is left proper combinatorial follows for instance from prop. A.2.6.13 in [L-Topos], taking the set C_0 there to be

$$C_0 := \{\text{red}(\Lambda^k[n] \rightarrow \Delta[n])\}_{n \in \mathbb{N}, 0 \leq k \leq n},$$

the image under of the horn inclusions (the generating cofibrations in $\text{sSet}_{\text{Quillen}}$) under the left adjoint, from observation 3.6.82, to the inclusion functor. \square

Lemma 3.6.85. *Under the inclusion $\text{sSet}_0 \rightarrow \text{sSet}$ a fibration with respect to the model structure from prop. 3.6.84 maps to a fibration in $\text{sSet}_{\text{Quillen}}$ precisely if it has the right lifting property against the morphism $(* \rightarrow S^1) := \text{red}(\Delta[0] \rightarrow \Delta[1])$.*

In particular it maps fibrant objects to fibrant objects.

The first statement appears as lemma 6.6. in [GoJa99]. The second (an immediate consequence) as corollary 6.8.

Proposition 3.6.86. *The adjunction*

$$\text{sSet}_0 \begin{array}{c} \xleftarrow{i} \\ \xrightarrow{E_1} \end{array} \text{sSet}_{\text{Quillen}}^{*/}$$

from observation 3.6.6.2 is a Quillen adjunction between the model structure from prop. 3.6.84 and the co-slice model structure, prop. 3.6.17, of $\text{sSet}_{\text{Quillen}}$ under the point. This presents the full inclusion

$$\infty \text{Grpd}_{\geq 1}^{*/} \hookrightarrow \infty \text{Grpd}^{*/}$$

of connected pointed ∞ -groupoids into all pointed ∞ -groupoids.

Proof. It is clear that the inclusion preserves cofibrations and acyclic cofibrations, in fact all weak equivalences. Since the point is necessarily cofibrant in $\text{sSet}_{\text{Quillen}}$, the model structure on the right is by prop. 3.6.21 indeed a presentation of $\infty \text{Grpd}^{*/}$.

We claim now that the derived ∞ -adjunction of this Quillen adjunction presents a homotopy full and faithful inclusion whose essential image consists of the connected pointed objects. For homotopy full- and faithfulness it is sufficient to show that for the derived functors there is a natural weak equivalence

$$\text{id} \simeq \mathbb{R}E_1 \circ \mathbb{L}i .$$

This is the case, because by prop. 3.6.85 the composite derived functors are computed by the composite ordinary functors precomposed with a fibrant replacement functor P , so that we have a natural morphism

$$X \xrightarrow{\simeq} PX = E_1 \circ i(PX) \simeq (\mathbb{R}E_1) \circ (\mathbb{L}i)(X) .$$

Hence $\mathbb{L}i$ is homotopy full-and faithful and by prop. 3.6.83 its essential image consists of the connected pointed objects. \square

3.6.7 Groupoids

In any ∞ -topos \mathbf{H} we may consider groupoids *internal* to \mathbf{H} , in the sense of internal category theory (as exposed for instance in the introduction of [L-Cat]).

Such a *groupoid object* \mathcal{G} in \mathbf{H} is an \mathbf{H} -object \mathcal{G}_0 “of \mathcal{G} -objects” together with an \mathbf{H} -object \mathcal{G}_1 “of \mathcal{G} -morphisms” equipped with source and target assigning morphisms $s, t : \mathcal{G}_1 \rightarrow \mathcal{G}_0$, an identity-assigning morphism $i : \mathcal{G}_0 \rightarrow \mathcal{G}_1$ and a composition morphism $\mathcal{G}_1 \times_{\mathcal{G}_0} \mathcal{G}_1 \rightarrow \mathcal{G}_1$ that all satisfy the axioms of a groupoid (unitalness, associativity, existence of inverses) up to coherent homotopy in \mathbf{H} . One way to formalize what it means for these axioms to hold up to coherent homotopy is the following.

One notes that ordinary groupoids, i.e. groupoid objects internal to Set , are characterized by the fact that their nerves are simplicial objects $\mathcal{G}_\bullet : \Delta^{\text{op}} \rightarrow \text{Set}$ in Set such that all groupoidal Segal maps (see def. 3.6.88 below) are isomorphisms. This turns out to be a characterization that makes sense generally internal to higher categories: a groupoid object in \mathbf{H} is an ∞ -functor $\mathcal{G} : \Delta^{\text{op}} \rightarrow \mathbf{H}$ such that all groupoidal Segal morphisms are equivalences in \mathbf{H} . This defines an ∞ -category $\text{Grpd}(\mathbf{H})$ of groupoid objects in \mathbf{H} .

Here a subtlety arises that is the source of a lot of interesting structure in higher topos theory: by the discussion in 2.2 the very objects of \mathbf{H} are already to be regarded as “structured ∞ -groupoids” themselves. Indeed, there is a full embedding $\text{const} : \mathbf{H} \hookrightarrow \text{Grpd}(\mathbf{H})$ that forms constant simplicial objects and thus regards every object $X \in \mathbf{H}$ as a groupoid object which, even though it has a trivial object of morphisms, already has a structured ∞ -groupoid of objects. This embedding is in fact reflective, with the reflector given by forming the ∞ -colimit over a simplicial diagram

$$\mathbf{H} \begin{array}{c} \xleftarrow{\quad \lim \quad} \\ \xrightarrow{\quad \text{const} \quad} \end{array} \text{Grpd}(\mathbf{H}) .$$

For \mathcal{G} a groupoid object in \mathbf{H} , the object $\lim \mathcal{G}_\bullet$ in \mathbf{H} may be thought of as the ∞ -groupoid obtained from “gluing together the object of objects of \mathcal{G} along the object of morphisms of \mathcal{G} ”. This idea that groupoid objects in an ∞ -topos are like structured ∞ -groupoids together with gluing information is formalized by the theorem that groupoid objects in \mathbf{H} are equivalent to the *effective epimorphisms* $Y \twoheadrightarrow X$ in \mathbf{H} , the intrinsic notion of *cover* (of X by Y) in \mathbf{H} . The effective epimorphism / cover corresponding to a groupoid object \mathcal{G} is the colimiting cocone $\mathcal{G}_0 \twoheadrightarrow \lim \mathcal{G}_\bullet$. This state of affairs is a fundamental property of ∞ -toposes, and as such part of the ∞ -Giraud axioms def. 2.2.2.

The following statement refines the third ∞ -Giraud axiom, Definition 2.2.2.

Theorem 3.6.87. *There is a natural equivalence of ∞ -categories*

$$\text{Grpd}(\mathbf{H}) \simeq (\mathbf{H}^{\Delta[1]})_{\text{eff}} ,$$

where $(\mathbf{H}^{\Delta[1]})_{\text{eff}}$ is the full sub- ∞ -category of the arrow category $\mathbf{H}^{\Delta[1]}$ of \mathbf{H} on the effective epimorphisms, Definition 3.6.38.

This appears below Corollary 6.2.3.5 in [L-Topos].

3.6.7.1 General abstract We briefly recall the notion of *groupoid objects* in an ∞ -topos from [L-Topos] with a note on how this notion axiomatizes that of ∞ -groupoids with geometric structure and *equipped with an atlas* (a choice of *object of objects*) in 3.6.7.1.1. Then we discuss the notion of the ∞ -group of *bisections* associated to such a choice of atlas in 3.6.7.1.2 and how these arrange to *Lie-Rinehart pairs* describing ∞ -groupoids with atlases. Finally, by the 1-image factorization every morphism in an ∞ -topos induces an atlas on its 1-image ∞ -groupoid. This universal construction we identify as a generalization of the traditional notion of Atiyah groupoids, which we discuss in 3.6.7.1.3.

- 3.6.7.1.1 – Atlases;
- 3.6.7.1.2 – Group of bisections;
- 3.6.7.1.3 – Atiyah groupoids.

3.6.7.1.1 Atlases On the one hand, *every* object in an ∞ -topos \mathbf{H} may be thought of as being an ∞ -groupoid equipped with certain structure, notably with geometric or cohesive structure. On the other hand, traditional notions of geometric groupoids, such as *Lie groupoids* (discussed in detail in 4.4.3 below), typically involve (often implicitly) more data: the additional choice of an *atlas*, def. 2.3.4. An extreme example is the *pair groupoid* on some space X , which we discuss as example 3.6.93 below. As just an object of \mathbf{H} every pair groupoid is trivial: it is equivalent to the point; but what traditional literature really means (often implicitly) by the pair groupoid is the groupoid-with-atlas $X \rightarrow *$ with X regarded as an atlas of the point.

Abstractly, an atlas on an ∞ -groupoid in \mathbf{H} is just a 1-epimorphism in \mathbf{H} . Here we discuss this notion of *∞ -groupoids with atlas*. This gives us occasion to put one of the Giraud-Rezk-Lurie axioms, def. 2.2.2, into a higher geometric context and to establish some perspective on ∞ -groupoids which is crucial in the succeeding discussion.

Definition 3.6.88. A *groupoid object* in an ∞ -topos \mathbf{H} is a simplicial object

$$\mathcal{G} : \Delta^{\text{op}} \rightarrow \mathbf{H}$$

such that all its groupoidal Segal maps are equivalences: for every $n \in \mathbb{N}$ and every partition $[k] \cup [k'] \rightarrow [n]$ into two subsets with exactly one joint element $\{*\} = [k] \cap [k']$, the canonical diagram

$$\begin{array}{ccc} \mathcal{G}[n] & \longrightarrow & \mathcal{G}[k] \\ \downarrow & & \downarrow \\ \mathcal{G}[k'] & \longrightarrow & \mathcal{G}[*] \end{array}$$

is an ∞ -pullback diagram.

Write

$$\text{Grpd}(\mathbf{H}) \subset \text{Func}(\Delta^{\text{op}}, \mathbf{H})$$

for the full subcategory of the ∞ -category of simplicial objects in \mathbf{H} on the groupoid objects.

This is def. 6.1.2.7 of [L-Topos], using prop. 6.1.2.6.

Example 3.6.89. For $Y \rightarrow X$ any morphism in \mathbf{H} , there is a groupoid object $\check{C}(Y \rightarrow X)$ which in degree n is the $(n + 1)$ -fold ∞ -fiber product of Y over X with itself

$$\check{C}(Y \rightarrow X) : [n] \mapsto Y \times_X^{n+1}$$

This appears in [L-Topos] as prop. 6.1.2.11. The following statement strengthens the third ∞ -Giraud axiom of def. 2.2.2.

Theorem 3.6.90. *In an ∞ -topos \mathbf{H} we have*

1. *Every groupoid object in \mathbf{H} is effective: the canonical morphism $\mathcal{G}_0 \rightarrow \varinjlim \mathcal{G}_\bullet$ is an effective epimorphism, and \mathcal{G} is equivalent to the Čech nerve of this effective epimorphism.*

Moreover, this extends to a natural equivalence of ∞ -categories

$$\mathrm{Grpd}(\mathbf{H}) \simeq (\mathbf{H}^{\Delta[1]})_{\mathrm{eff}},$$

where on the right we have the full sub- ∞ -category of the arrow category of \mathbf{H} on the effective epimorphisms.

2. *The ∞ -pullback along any morphism preserves ∞ -colimits*

$$\begin{array}{ccccc} \lim_{\rightarrow_i} f^* P_i & \simeq & f^* \lim_{\rightarrow_i} P_i & \longrightarrow & \lim_{\rightarrow_i} P_i \\ & & \downarrow & & \downarrow \\ & & Y & \xrightarrow{f} & X \end{array}$$

This are two of the *Giraud-Rezk-Lurie axioms*, def. 2.2.2, that characterize ∞ -toposes. (The equivalence of ∞ -categories in the first point follows with the remark below corollary 6.2.3.5 of [L-Topos].)

Remark 3.6.91. If geometric structure is understood (as in a cohesive ∞ -topos), there is a slight ambiguity in the word *groupoid* as usually used: in one sense every object of an ∞ -topos itself is already a *parameterized ∞ -groupoid* (an ∞ -sheaf of ∞ -groupoids, def. 2.2.1). However, for instance the literature on *Lie groupoid* theory often (and often implicitly) takes a choice of *object of objects* as part of the data of a Lie groupoid. For instance the notion of *group of bisection* of a Lie groupoid X or of its associated *Lie algebroid* both require that the inclusion of a manifold of objects is specified, a morphism $X_0 \rightarrow X$. This choice is genuine extra structure on X , as it is not in general preserved by equivalences on X . The main technical requirement on this choice is that it indeed captures “all objects” of the groupoid, up to equivalence. One often says that the inclusion has to be an *atlas* of X . In the general abstract terms of ∞ -topos theory this means simply that $X_0 \rightarrow X$ is a *1-epimorphism*, remark 2.3.4.

In view of this we interpret theorem 3.6.90: if we follow remark 2.3.4 and call a 1-epimorphism in an ∞ -topos an *atlas* of its codomain parameterized ∞ -groupoid, then the *groupoid objects* of def. 3.6.88 are really the “parameterized ∞ -groupoids equipped with a choice of atlas”. (In traditional geometric groupoid theory the atlas (the domain object) is usually required to be 0-truncated, and this is often the choice of interest, also in applications of higher geometry, but in general every 1-epimorphism qualifies as an *atlas* in this sense.)

With this understood, the following definitions axiomatize and generalize standard constructions in traditional geometric groupoid theory. That they indeed reduce to these traditional notions is shown below in 4.4.3.

Example 3.6.92. For $G \in \mathrm{Grp}(\mathbf{H})$ an ∞ -group, 3.6.8, its delooping $\mathbf{B}G$ is essentially uniquely pointed, and this point inclusion $* \longrightarrow \mathbf{B}G$ is a 1-epimorphism (for instance by prop. 3.6.39). Hence this is the canonical incarnation of the delooping of G as an ∞ -groupoid with atlas. In terms of this we may read theorem 3.6.113 as saying that *∞ -groups are equivalent to their delooping ∞ -groupoids with canonical atlases.*

Example 3.6.93. By def. 3.6.68 an object $X \in \mathbf{H}$ is called *inhabited* if the canonical morphism to the terminal object is a 1-epimorphism. Therefore for X inhabited the map $X \longrightarrow *$ may be regarded as an ∞ -groupoid with atlas. To see what this means consider its Čech nerve, which is of course of the form

$$\left(\cdots \begin{array}{c} \rightrightarrows \\ \rightrightarrows \\ \rightrightarrows \end{array} X \times X \begin{array}{c} \xrightarrow{p_1} \\ \xrightarrow{p_2} \end{array} X \right) \in \mathbf{H}^{\Delta^{\mathrm{op}}}.$$

This is a groupoid object whose objects are the points of X , whose morphisms are ordered pairs of points in X , and where composition is given in the evident way. This is what in the literature is known as the *pair groupoid* of X .

$$\text{Pair}(X) := \left(X \longrightarrow * \right) \in (\mathbf{H}^{\Delta^1})_{\text{eff}} \simeq \text{Grpd}(\mathbf{H}).$$

Almost trivial as it may seem, the pair groupoid plays an important role for instance in the theory of Atiyah groupoids, discussed below in 3.6.7.1.3.

As these examples show, often it is more convenient to work with the atlas than with the groupoid object that it equivalently corresponds to. The following proposition shows how to compute ∞ -limits in this perspective.

Proposition 3.6.94. *An ∞ -limit of a diagram in $(\mathbf{H}^{\Delta^1})_{\text{eff}}$ is given by the (-1) -truncation projection of the ∞ -limit of the underlying diagram in \mathbf{H}^{Δ^1} . Hence if $A : J \rightarrow (\mathbf{H}^{\Delta^1})_{\text{eff}}$ is a diagram with underlying diagrams $X := \partial_1 \circ A$ and $Y := \partial_2 \circ A$ in \mathbf{H} , then*

$$\lim_{\longleftarrow j} A_j \simeq \left(\lim_{\longleftarrow j} X_j \rightarrow \text{im}_1 \left(\lim_{\longleftarrow j} X_j \longrightarrow \lim_{\longleftarrow j} Y_j \right) \right).$$

Proof. One checks the defining universal property by the orthogonal factorization system of prop. 3.6.33. \square

3.6.7.1.2 Group of Bisections We discuss here the description of ∞ -groupoids $X \in \mathbf{H}$ equipped with *atlases* $X_0 \longrightarrow X$ in terms of their ∞ -groups $\mathbf{Aut}_X(X_0)$ of autoequivalences of X_0 over X . In the case that \mathbf{H} is the ∞ -topos of smooth cohesion described below in 4.4 and for the example that X is presented by a traditional *Lie groupoid* this is the group which is traditionally known as the *group of bisections* of X , this we discuss in 4.4.3.1 below. Since this is a good descriptive term also in the general case, we here generally speak of $\mathbf{Aut}_X(X_0)$ as the *∞ -group of bisections*.

Due to their special construction, groups of bisections have special properties. In the traditional literature these are best known after Lie differentiation: again for X a Lie groupoid, the pair $(C^\infty(X_0), \text{Lie}(\mathbf{Aut}_X(X_0)))$ consisting of the associative algebra of smooth functions on X_0 and the Lie algebra of the group of bisections is known as the *Lie-Rinehart algebra pair* associated with the groupoid. It enjoys the special property that each of the two algebras is equipped with an action of the other algebra in a compatible way. This is an equivalent way of encoding the *Lie algebroid* associated with the Lie groupoid X .

Definition 3.6.95. For $X_\bullet \in \mathbf{H}^{\Delta^{\text{op}}}$ a groupoid object in an ∞ -topos, def. 3.6.88, with $\phi_X : X_0 \longrightarrow X$ the corresponding 1-epimorphism by theorem 3.6.90 (the *atlas* by remark 3.6.91), we say that the *group of bisections* $\mathbf{BiSect}(\phi_X) \in \text{Grp}(\mathbf{H})$ of X_\bullet (also written $\mathbf{BiSect}_X(X_0)$ if the morphism p_X is understood) is the relative automorphism group, def. 3.6.11, of X_0 over X :

$$\mathbf{BiSect}_X(X_0) := \mathbf{Aut}_{\mathbf{H}}(p_X) := \prod_X \mathbf{Aut}(p_X).$$

Remark 3.6.96. We discuss how this general abstract notion reduces to that of the group of bisections of a Lie groupoid as traditionally defined below in prop. 4.4.23.

Definition 3.6.97. The *atlas automorphisms* $\mathbf{AtlasAut}_X(X_0)$ of the atlas $\phi_X : X_0 \longrightarrow X$ is the 1-image of the morphism p_X of def. 3.6.9, hence the factorization of p_X as

$$\mathbf{BiSect}_X(X_0) \xrightarrow{p} \mathbf{AtlasAut}_X(X_0) \hookrightarrow \mathbf{Aut}(X).$$

Proposition 3.6.98. For $X_\bullet \in \mathbf{H}^{\Delta^{\text{op}}}$ a groupoid object in an ∞ -topos, def. 3.6.88, with $\phi_X : X_0 \twoheadrightarrow X$ the corresponding 1-epimorphism by theorem 3.6.90, we have a fiber sequence

$$\Omega_{\phi_X}[X_0, X]^{\subset} \longrightarrow \mathbf{BiSect}_X(X_0) \xrightarrow{p} \mathbf{AtlasAut}_X(X_0)$$

in $\mathbf{Grp}(\mathbf{H})$ which exhibits $\mathbf{BiSect}_X(X_0)$ as an ∞ -group extension of $\mathbf{AtlasAut}_X(X_0)$ by the automorphism ∞ -group of the atlas X_0 inside X .

Proof. Since $\mathbf{AtlasAut}_X(X_0)$ is by definition the 1-image of the morphism $p : \mathbf{BiSect}_X(X_0) \rightarrow \mathbf{Aut}(X)$ the statement is equivalent to the diagram

$$\Omega_{\nabla}[X, X]^{\subset} \longrightarrow \mathbf{BiSect}_X(X_0) \xrightarrow{p} \mathbf{Aut}(X)$$

being a fiber sequence, since, by the pasting law, with the bottom square in the following diagram being an ∞ -pullback, the top square is precisely so if the outer rectangle is.

$$\begin{array}{ccc} \Omega_{\nabla}[X_0, X] & \longrightarrow & \mathbf{BiSect}_X(X_0) \\ \downarrow & & \downarrow p \\ * & \longrightarrow & \mathbf{AtlasAut}_X(X_0) \\ \downarrow & & \downarrow \text{hook} \\ * & \longrightarrow & \mathbf{Aut}(X) \end{array}$$

That the outer rectangle is an ∞ -pullback is the statement of prop. 3.6.16. □

Remark 3.6.99. The sequence of prop. 3.6.98 is actually the sequence of bisection groups induced by a fiber sequence of ∞ -groupoids with atlases: the generalized *Atiyah sequence*. This we discuss below in 3.6.7.1.3.

Example 3.6.100. For $X \in \mathbf{H}$ inhabited, the group of bisections of the pair groupoid $\text{Pair}(X)$, example 3.6.93, is canonically equivalent to $\mathbf{Aut}(X)$:

$$\mathbf{BiSect}(\text{Pair}(X)) \simeq \mathbf{Aut}(X).$$

Example 3.6.101. For $X \in \mathbf{H} \xrightarrow{\text{const}} \mathbf{Grpd}(\mathbf{H})$ the constant groupoid object on X , its group of bisections is the trivial group

$$\mathbf{BiSect}(\text{const}X) \simeq *.$$

Proof. By example 3.6.3 the identity morphism on X is the terminal object in the slice ∞ -topos $\mathbf{H}/_X$. □

3.6.7.1.3 Atiyah groupoids By the 1-image factorization, def. 3.6.31, every morphism in an ∞ -topos induces an atlas for an ∞ -groupoid, in the sense discussed above in 3.6.7.1.1. If the codomain is a pointed connected object, hence of the form \mathbf{BG} for some ∞ -group G , then we may equivalently think of this ∞ -groupoid with atlas as associated to the corresponding G -principal ∞ -bundle over the domain, discussed below in 3.6.10. One finds that this construction generalizes the traditional notion of the Lie groupoid which Lie integrates the *Atiyah Lie algebroid* of a smooth principal bundle (this traditional example we discuss in 4.4.3.2 below). Therefore we generally speak of *Atiyah ∞ -groupoids*.

A special case this construction relevant for codomains that are moduli ∞ -stacks specifically for *differential cocycles* are *Courant groupoids* which we discuss below in 3.9.13.6.

Note. This section partly refers to definitions and results in the theory of principal ∞ -bundles which we discuss only below in 3.6.10. We nevertheless group the discussion of Atiyah groupoids here since one of the key aspects of their general definition in ∞ -toposes is that they apply much more generally than just to principal ∞ -bundles.

A fundamental construction in the traditional theory of G -principal bundles $P \rightarrow X$ is that of the corresponding *Atiyah Lie algebroid* and that of the Lie groupoid which integrates it, which we will call the *Atiyah groupoid* $\text{At}(P)$. In words this is the Lie groupoid whose manifold of objects is X , and whose morphisms between two points are the G -equivariant maps between the fibers of P over these points. Observing that a G -equivariant map between two G -torsors over the point is fixed by its image on any one point, this groupoid is usually written as on the left of

$$\begin{array}{ccc} \text{At}(P) & \rightarrow & \text{Pair}(X) \\ = & & = \\ \left(\begin{array}{c} (P \times P)/_{\text{diag}} G \\ \updownarrow \\ X \end{array} \right) & & \left(\begin{array}{c} X \times X \\ \updownarrow \\ X \end{array} \right) . \end{array}$$

There is a conceptual simplification to this construction when expressed in terms of the smooth moduli stack \mathbf{BG} of G -principal bundles (in the smooth model for cohesion, discussed below in 4.4): if $\nabla^0 : X \rightarrow \mathbf{BG}$ is the map which modulates $P \rightarrow X$, then

Proposition 3.6.102. *The space of morphisms of $\text{At}(P)$ is naturally identified with the homotopy fiber product of ∇^0 with itself:*

$$(P \times P)/_{\text{diag}} G \simeq X \times_{\mathbf{BG}} X .$$

Moreover, the canonical atlas of the Atiyah groupoid, given by the canonical inclusion $p_{\text{At}(P)} : X \twoheadrightarrow \text{At}(P)$, is equivalently the homotopy-colimiting cocone under the full Čech nerve of the classifying map ∇^0 :

$$\cdots \cdots X \times_{\mathbf{BG}} X \times_{\mathbf{BG}} X \begin{array}{c} \xrightarrow{\quad} \\ \xleftarrow{\quad} \\ \xrightarrow{\quad} \\ \xleftarrow{\quad} \\ \xrightarrow{\quad} \end{array} X \times_{\mathbf{BG}} X \begin{array}{c} \xrightarrow{\quad} \\ \xleftarrow{\quad} \\ \xrightarrow{\quad} \\ \xleftarrow{\quad} \\ \xrightarrow{\quad} \end{array} X \xrightarrow{p_{\text{At}(P)}} \left(\lim_{\rightarrow n} X \times_{\mathbf{BG}}^{n+1} \right) \simeq \text{At}(P) .$$

This is by direct verification, the details of this example are discussed below in 4.4.3.2. In terms of groups of bisections the above proposition 3.6.102 becomes:

Proposition 3.6.103. *The Atiyah groupoid $\text{At}(P)$ of a smooth G -principal bundle $P \rightarrow X$ is the Lie groupoid which is universal with the property that its group of bisections is naturally equivalent to the group of automorphisms of the modulating map ∇^0 of $P \rightarrow X$ in the slice:*

$$\begin{array}{ccc} \mathbf{BiSect}(\text{At}(P)) & \simeq & \mathbf{Aut}_{\mathbf{H}}(\nabla^0) \\ = & & = \\ \left\{ \begin{array}{ccc} X & \xrightarrow{\phi} & X \\ & \swarrow \cong & \searrow \\ p_{\text{At}(P)} & & p_{\text{At}(P)} \\ & \searrow & \swarrow \\ & \text{At}(P) & \end{array} \right\} & & \left\{ \begin{array}{ccc} X & \xrightarrow{\phi} & X \\ & \swarrow \cong & \searrow \\ \nabla^0 & & \nabla^0 \\ & \searrow & \swarrow \\ & \mathbf{BG} & \end{array} \right\} . \end{array}$$

In terms of 1-image factorizations we may naturally understand proposition 3.6.102 as saying that (the atlas of) the Atiyah groupoid provides the essentially unique factorization

$$\nabla^0 : X \xrightarrow{p_{\text{At}(P)}} \text{At}(P) \hookrightarrow \mathbf{BG}$$

of the modulating map ∇^0 of $P \rightarrow X$ by a 1-epimorphism of stacks followed by a 1-monomorphism, namely the *first relative Postnikov stage* of ∇^0 , in the context of smooth stacks. As for traditional relative Postnikov theory in traditional homotopy theory, this characterizes $\text{At}(P)$ uniquely as receiving an epimorphism on smooth connected components from X (the atlas $p_{\text{At}(P)}$), while at the same time having a *fully faithful embedding* into \mathbf{BG} . This being fully faithful directly implies that the components of any natural transformation from ∇^0 to itself necessarily factor through this fully faithful inclusion:

$$\left\{ \begin{array}{ccc} X & \xrightarrow{\phi} & X \\ & \searrow \nabla^0 & \swarrow \nabla^0 \\ & \mathbf{BG} & \end{array} \right\} \cong \left\{ \begin{array}{ccc} X & \xrightarrow{\phi} & X \\ & \searrow p & \swarrow p \\ & \text{At}(P) & \\ & \searrow \nabla^0 & \swarrow \nabla^0 \\ & \mathbf{BG} & \end{array} \right\} .$$

This relation translates to a proof of prop. 3.6.103.

This discussion of Atiyah groupoids of traditional G -principal bundles generalizes directly now to bundles in an ∞ -topos.

Definition 3.6.104. Let $\phi : X \rightarrow \mathbf{F}$ a morphism in \mathbf{H} . We say that its 1-image projection, def. 3.6.31,

$$X \twoheadrightarrow \text{im}_1(\phi) ,$$

regarded as an ∞ -groupoid $\text{im}_1(\phi)$ with atlas X by remark 2.3.4, is the *Atiyah groupoid* $\text{At}(\phi) \in \text{Epi}_1(\mathbf{H})$ of ϕ .

Here for the direct generalization of the traditional notion of Atiyah groupoids we set $\mathbf{F} = \mathbf{BG}$ the delooping of some ∞ -group. But the definition and many of its uses does not depend on this restriction. An exception is the following fact, which generalizes a standard theorem about Atiyah groupoids known from textbooks on differential geometry.

Proposition 3.6.105. For $G \in \text{Grp}(\mathbf{H})$ an ∞ -group, every G -principal ∞ -bundle $P \rightarrow X$ in \mathbf{H} , def. 3.6.152, over an inhabited object X , def. 3.6.68, is equivalently the source-fiber of a transitive higher groupoid $\mathcal{G} \in \text{Grpd}(\mathbf{H})$ with vertex ∞ -group G . Here in particular we can set $\mathcal{G} = \text{At}(P)$.

Proof. For $P \rightarrow X$ a G -principal ∞ -bundle, write $g : X \rightarrow \mathbf{BG}$ for the map that modulates it by theorem 3.6.167. Then the outer rectangle of

$$\begin{array}{ccccc} P & \twoheadrightarrow & * & \xrightarrow{\simeq} & * \\ \downarrow & & \downarrow x & & \downarrow \\ X & \twoheadrightarrow & \text{At}(P) & \hookrightarrow & \mathbf{BG} \\ & \searrow g & & & \end{array}$$

is an ∞ -pullback by that theorem 3.6.167. Also the right sub-square is an ∞ -pullback (for any global point $x \in X$) because by ∞ -pullback stability of 1-epimorphisms (prop. 2.3.5) and 1-monomorphisms (prop.

3.6.34), the top right morphism is a 1-monomorphism from an inhabited object to the terminal object, hence is not just a 1-mono but also a 1-epi and hence is an equivalence. Now by the pasting law for ∞ -pullbacks, prop. 2.3.2, also the left sub-square is an ∞ -pullback and this exhibits P as the source fiber of $\text{At}(P)$ over $x \in X$. \square

Proposition 3.6.106. *For $\phi : X \rightarrow \mathbf{F}$ a morphism, there is a canonical equivalence*

$$\mathbf{BiSect}(\text{At}(\phi)) \simeq \mathbf{Aut}_{\mathbf{H}}(\phi)$$

between the ∞ -group of bisections, def. 3.6.95, of the higher Atiyah groupoid of ϕ , def. 3.6.104, and the \mathbf{H} -valued automorphism ∞ -group of ϕ

Moreover, the ∞ -group of bisections of the higher Atiyah ∞ -groupoid sits in a homotopy fiber sequence of ∞ -groups of the form

$$\begin{array}{ccccc} \Omega_{\phi}[X, \mathbf{F}] & \longrightarrow & \mathbf{BiSect}(\text{At}(\phi)) & \longrightarrow & \mathbf{Aut}(X) , \\ & & \simeq & & \\ & & \mathbf{Aut}_{\mathbf{H}}(\phi) & & \end{array}$$

where on the right we have the canonical forgetful map.

Proof. This is the restriction of the statement of prop. 3.6.43 to those endomorphisms that are equivalences. \square

Definition 3.6.107 (Atiyah sequence). For $\phi : X \rightarrow \mathbf{BG}$ a cocycle, write

$$\text{At}(\phi) \xrightarrow{p} \text{Pair}(X)$$

for the morphism of groupoid objects to the *pair groupoid* of X , example 3.6.93, given by the canonical map of atlases

$$\begin{array}{ccc} X & \xrightarrow{\text{id}} & X \\ \downarrow & & \downarrow \\ \text{im}_1(\phi) & \longrightarrow & * \end{array} .$$

We say that the ∞ -fiber sequence of this morphism over X

$$\text{ad}(\phi) \longrightarrow \text{At}(\phi) \longrightarrow \text{Pair}(X) ,$$

is the *Atiyah sequence* of ϕ , hence the sequence given by the ∞ -pullback diagram

$$\begin{array}{ccc} \text{ad}(\phi) & \longrightarrow & X \\ \downarrow & & \downarrow \\ \text{At}(\phi) & \xrightarrow{p} & \text{Pair}(X) \end{array} .$$

Proposition 3.6.108. *Given $\phi : X \rightarrow \mathbf{BG}$, the induced sequence of groups of bisections, def. 3.6.95, is the sequence of prop. 3.6.98.*

Proof. By prop. 3.6.100 and prop. 3.6.106 the morphism of groupoid objects $\text{At}(\phi) \rightarrow \text{Pair}(X)$ induces the morphism of groups of bisections $\mathbf{Aut}(\phi) \rightarrow \mathbf{Aut}(X)$. Therefore it remains to show that $\text{ad}(\phi) \rightarrow \text{At}(\phi)$ is as claimed.

By prop. 3.6.94 we obtain $\text{ad}(\phi)$ as the 1-image factorization of the limit in \mathbf{H}^{Δ^1} over

$$\begin{array}{ccccc} X & \xrightarrow{\text{id}} & X & \longleftarrow & X \\ \downarrow & & \downarrow & & \downarrow \text{id} \\ \text{im}_1(\phi) & \longrightarrow & * & \longleftarrow & X \end{array},$$

hence the 1-image factorization of the diagonal $X \longrightarrow X \times \text{im}_1(\phi)$. Moreover by prop. 3.6.106 the group of bisections of this image factorization is equivalently that of the morphism itself. Now a bisection of the diagonal, hence a diagram

$$\begin{array}{ccc} X & \xrightarrow{\simeq} & X \\ & \searrow & \swarrow \\ & X \times \text{im}_1(\phi) & \end{array}$$

is equivalently a pair of a diagrams of the form

$$\begin{array}{ccc} X & \xrightarrow{f} & X \\ & \searrow & \swarrow \\ & X & \end{array}, \quad \begin{array}{ccc} X & \xrightarrow{f} & X \\ & \searrow & \swarrow \\ & \text{im}_1(\phi) & \end{array}$$

that share the top horizontal morphism, as indicated. By example 3.6.101 the ∞ -groupoid of diagrams as on the left is contractible, hence up to essentially unique equivalence we have $f = \text{id}$. This reduces the diagram on the right to an automorphism of ϕ , as claimed. \square

The Atiyah groupoid acts on sections of the corresponding bundle and its associated bundles:

Definition 3.6.109. For $G \in \text{Grp}(\mathbf{H})$ an ∞ -group, for $P \rightarrow X$ a G -principal ∞ -bundle modulated by a map $g : X \rightarrow \mathbf{B}G$, and for $\rho : V//G \rightarrow \mathbf{B}G$ an action of G on some $V \in \mathbf{H}$, write

$$(P \times_G V)//\text{At}(P) \rightarrow \text{At}(P)$$

for the ∞ -pullback of ρ along the defining 1-monomorphism from the Atiyah groupoid of P . Then by the pasting law, prop. 2.3.2, and by the characterization of the universal ρ -associated bundle, prop. 3.6.206, we have an ∞ -pullback square as on the left of the following diagram:

$$\begin{array}{ccccc} P \times_G V & \longrightarrow & (P \times_G V)//\text{At}(P) & \longrightarrow & V//G \\ \downarrow & & \downarrow & & \downarrow \rho \\ X & \longrightarrow & \text{At}(P) & \longrightarrow & \mathbf{B}G \\ & \searrow & & \swarrow & \\ & & & & g \end{array}$$

This exhibits $(P \times_G V)//\text{At}(P)$ as a groupoid action of $\text{At}(P)$ on the associated V -fiber bundle $P \times_G V \rightarrow X$. This we call the *canonical Atiyah-groupoid action on sections*.

3.6.8 Groups

Every ∞ -topos \mathbf{H} comes with a notion of ∞ -group objects that generalizes the ordinary notion of group objects in a topos as well as that of grouplike A_∞ -spaces in $\text{Top} \simeq \infty\text{Grpd}$ [Sta63b]. Operations of *looping*

and *delooping* identify ∞ -group objects with pointed connected objects. If moreover \mathbf{H} is cohesive then it follows that every connected object is canonically pointed, and hence every connected object uniquely corresponds to an ∞ -group object.

This section to a large extent collects and reviews general facts about ∞ -group objects in ∞ -toposes from [L-Topos] and [L-Alg]. We add some observations that we need later on.

3.6.8.1 General abstract

Definition 3.6.110. Write

- $\mathbf{H}^{*/}$ for the ∞ -category of pointed objects in \mathbf{H} ;
- $\mathbf{H}_{\geq 1}$ for the full sub- ∞ -category of \mathbf{H} on the connected objects;
- $\mathbf{H}_{\geq 1}^{*/}$ for the full sub- ∞ -category of the pointed and connected objects.

Definition 3.6.111. Write

$$\Omega : \mathbf{H}^{*/} \rightarrow \mathbf{H}$$

for the ∞ -functor that sends a pointed object $* \rightarrow X$ to its *loop space object*: the ∞ -pullback

$$\begin{array}{ccc} \Omega X & \longrightarrow & * \\ \downarrow & & \downarrow \\ * & \longrightarrow & X \end{array} .$$

Definition 3.6.112. An ∞ -group in \mathbf{H} is an A_∞ -algebra G in \mathbf{H} such that $\pi_0(G)$ is a group object. Write $\text{Grp}(\mathbf{H})$ for the ∞ -category of ∞ -groups in \mathbf{H} .

This is def. 5.1.3.2 in [L-Alg], together with remark 5.1.3.3.

Theorem 3.6.113. *Every loop space object canonically has the structure of an ∞ -group, and this construction extends to an ∞ -functor*

$$\Omega : \mathbf{H}^{*/} \rightarrow \text{Grp}(\mathbf{H}) .$$

This constitutes an equivalence of ∞ -categories

$$(\Omega \dashv \mathbf{B}) : \text{Grp}(\mathbf{H}) \begin{array}{c} \xleftarrow{\Omega} \\ \xrightarrow[\mathbf{B}]{\simeq} \end{array} \mathbf{H}_{\geq 1}^{*/}$$

of ∞ -groups with connected pointed objects in \mathbf{H} .

This is lemma 7.2.2.1 in [L-Topos]. (See also theorem 5.1.3.6 of [L-Alg] where this is the equivalence denoted ϕ_0 in the proof.)

Definition 3.6.114. We call the inverse $\mathbf{B} : \text{Grp}(\mathbf{H}) \rightarrow \mathbf{H}_{\geq 1}^{*/}$ the *delooping* functor of \mathbf{H} . By convenient abuse of notation we write \mathbf{B} also for the composite $\mathbf{B} : \infty\text{Grpd}(\mathbf{H}) \rightarrow \mathbf{H}_{\geq 1}^{*/} \rightarrow \mathbf{H}$ with the functor that forgets the basepoint and the connectedness.

Remark 3.6.115. While by prop. 3.4.3 every connected object in a cohesive ∞ -topos has a unique point, nevertheless the homotopy type of the full hom- ∞ -groupoid $\mathbf{H}^{*/}(\mathbf{B}G, \mathbf{B}H)$ of pointed objects in general differs from the hom ∞ -groupoid $\mathbf{H}(\mathbf{B}G, \mathbf{B}H)$ of the underlying unpointed objects.

For instance let $\mathbf{H} := \infty\text{Grpd}$ and let G be an ordinary group, regarded as a group object in ∞Grpd . Then $\mathbf{H}^{*/}(\mathbf{B}G, \mathbf{B}G) \simeq \text{Aut}(G)$ is the ordinary automorphism group of G , but $\mathbf{H}(\mathbf{B}G, \mathbf{B}G) = \text{AUT}(G)$ is the automorphism 2-group, example 1.2.80.

The more deloopings an ∞ -group admits, the “more abelian” it is:

Definition 3.6.116. A *braided* ∞ -group in \mathbf{H} is an ∞ -group $G \in \text{Grp}(\mathbf{H})$ equipped with the following equivalent additional structures:

1. a lift of the groupal $A_\infty \simeq E_1$ -algebra structure to an E_2 -algebra structure;
2. the structure of an ∞ -group on the delooping $\mathbf{B}G$;
3. a choice of double delooping \mathbf{B}^2G .

Definition 3.6.117. An *abelian* ∞ -group in \mathbf{H} is an ∞ -group $G \in \text{Grp}(\mathbf{H})$ equipped with the following equivalent additional structures:

1. a lift of the groupal $A_\infty \simeq E_1$ -algebra structure to an E_∞ -algebra structure;
2. coinductively: a choice of abelian ∞ -group structure on its delooping $\mathbf{B}G$.

Proposition 3.6.118. ∞ -groups G in \mathbf{H} are equivalently those groupoid objects, def. 3.6.88, \mathcal{G} in \mathbf{H} for which $\mathcal{G}_0 \simeq *$.

This is the statement of the compound equivalence $\phi_3\phi_2\phi_1$ in the proof of theorem 5.1.3.6 in [L-Alg].

Remark 3.6.119. This means that for G an ∞ -group object the Čech nerve extension of its delooping fiber sequence $G \rightarrow * \rightarrow \mathbf{B}G$ is the simplicial object

$$\cdots \rightrightarrows G \times G \rightrightarrows G \rightrightarrows * \longrightarrow \mathbf{B}G$$

that exhibits G as a groupoid object over $*$. In particular it means that for G an ∞ -group, the essentially unique morphism $* \rightarrow \mathbf{B}G$ is an effective epimorphism.

Definition 3.6.120. For $f : Y \rightarrow Z$ any morphism in \mathbf{H} and $z : * \rightarrow Z$ a point, the ∞ -fiber or *homotopy fiber* of f over this point is the ∞ -pullback $X := * \times_Z Y$

$$\begin{array}{ccc} X & \longrightarrow & * \\ \downarrow & & \downarrow \\ Y & \xrightarrow{f} & Z \end{array} .$$

Observation 3.6.121. Suppose that also Y is pointed and f is a morphism of pointed objects. Then the ∞ -fiber of an ∞ -fiber is the loop object of the base.

This means that we have a diagram

$$\begin{array}{ccccc} \Omega_z Z & \longrightarrow & X & \longrightarrow & * \\ \downarrow & & \downarrow & & \downarrow \\ * & \longrightarrow & Y & \xrightarrow{f} & Z \end{array} .$$

where the outer rectangle is an ∞ -pullback if the left square is an ∞ -pullback. This follows from the pasting law prop. 2.3.2.

3.6.8.2 Presentations We discuss presentations of the notion of ∞ -groups, 3.6.8.1, by simplicial groups in a category with weak equivalences.

Definition 3.6.122. One writes \overline{W} for the composite functor from simplicial groups to simplicial sets given by

$$\overline{W} : [\Delta^{\text{op}}, \text{Grpd}] \xrightarrow{[\Delta^{\text{op}}, \mathbf{B}]} [\Delta^{\text{op}}, \text{Grpd}] \xrightarrow{[\Delta^{\text{op}}, N]} [\Delta^{\text{op}}, \text{sSet}] \xrightarrow{T} \text{sSet} ,$$

where

- $[\Delta^{\text{op}}, \mathbf{B}] : [\Delta^{\text{op}}, \text{Grp}] \rightarrow [\Delta^{\text{op}}, \text{Grpd}]$ is the functor from simplicial groups to simplicial groupoids that sends degreewise a group to the corresponding one-object groupoid;
- $T : [\Delta^{\text{op}}, \text{sSet}] \rightarrow \text{sSet}$ is the total simplicial set functor, def. 2.3.23.

This simplicial delooping \overline{W} was originally introduced in components in [EM53], now a classical construction. The above formulation is due to [Dus75], see lemma 15 in [St11].

Remark 3.6.123. This functor takes values in *reduced* simplicial sets $\text{sSet}_{\geq 1} \hookrightarrow \text{sSet}$, those with precisely one vertex.

Remark 3.6.124. For G a simplicial group, the simplicial set $\overline{W}G$ is, by corollary 2.3.27, the homotopy colimit over a simplicial diagram in simplicial sets. Below in 3.6.10.4 we see that this simplicial diagram is that presenting the groupoid object $*//G$ which is the action groupoid of G acting trivially on the point.

Proposition 3.6.125. *The category sGrpd of simplicial groups carries a cofibrantly generated model structure for which the fibrations and the weak equivalences are those of $\text{sSet}_{\text{Quillen}}$ under the forgetful functor $\text{sGrpd} \rightarrow \text{sSet}$.*

Proof. This is theorem 2.3 in [GoJa99]. Since model structure is therefore transferred along the forgetful functor, it inherits generating (acyclic) cofibrations from those of $\text{sSet}_{\text{Quillen}}$. \square

Theorem 3.6.126. *The functor \overline{W} is the right adjoint of a Quillen equivalence*

$$(L \dashv \overline{W}) : \text{sGrp} \begin{array}{c} \xleftarrow{L} \\ \xrightarrow{\overline{W}} \end{array} \text{sSet}_{\geq 1} ,$$

with respect to the model structures of prop. 3.6.125 and prop. 3.6.84. In particular

- the adjunction unit is a weak equivalence

$$Y \xrightarrow{\sim} \overline{W}LY$$

for every $Y \in \text{sSet}_0 \hookrightarrow \text{sSet}_{\text{Quillen}}$

- $\overline{W}LY$ is always a Kan complex.

This is discussed for instance in chapter V of [GoJa99]. A new proof is given in [St11].

Definition 3.6.127. For G a simplicial group, write

$$WG \rightarrow \overline{W}G$$

for the décalage, def. 2.3.31, on $\overline{W}G$.

This characterization by décalage of the object going by the classical name WG is made fairly explicit on p. 85 of [Dus75]. The fully explicit statement is in [RoSt12].

Proposition 3.6.128. *The morphism $WG \rightarrow \overline{WG}$ is a Kan fibration resolution of the point inclusion $* \rightarrow \overline{WG}$.*

Proof. This follows directly from the characterization of $WG \rightarrow \overline{WG}$ by décalage. \square
 Pieces of this statement appear in [May67]: lemma 18.2 there gives the fibration property, prop. 21.5 the contractibility of WG .

Corollary 3.6.129. *For G a simplicial group, the sequence of simplicial sets*

$$G \longrightarrow WG \twoheadrightarrow \overline{WG}$$

is a presentation in $\mathbf{sSet}_{\text{Quillen}}$ by a pullback of a Kan fibration of the looping fiber sequence, theorem. 3.6.113,

$$G \rightarrow * \rightarrow \mathbf{BG}$$

in ∞Grpd .

Proof. One finds that G is the 1-categorical fiber of $WG \rightarrow \overline{WG}$. The statement then follows using prop. 3.6.128 in prop. 2.3.8. \square

The explicit statement that the sequence $G \rightarrow WG \rightarrow \overline{WG}$ is a model for the looping fiber sequence appears on p. 239 of [Por]. The universality of $WG \rightarrow \overline{WG}$ for G -principal simplicial bundles is the topic of section 21 in [May67], where however it is not made explicit that the “twisted cartesian products” considered there are precisely the models for the pullbacks as above. This is made explicit for instance on page 148 of [Por].

Corollary 3.6.130. *The Quillen equivalence $(L \dashv \overline{W})$ from theorem 3.6.126 is a presentation of the looping/delooping equivalence, theorem 3.6.113.*

We now lift all these statements from simplicial sets to simplicial presheaves.

Proposition 3.6.131. *If the cohesive ∞ -topos \mathbf{H} has site of definition C with a terminal object, then*

- *every ∞ -group object has a presentation by a presheaf of simplicial groups*

$$G \in [C^{\text{op}}, \mathbf{sGrp}] \xrightarrow{U} [C^{\text{op}}, \mathbf{sSet}]$$

which is fibrant in $[C^{\text{op}}, \mathbf{sSet}]_{\text{proj}}$;

- *the corresponding delooping object is presented by the presheaf*

$$\overline{WG} \in [C^{\text{op}}, \mathbf{sSet}_0] \hookrightarrow [C^{\text{op}}, \mathbf{sSet}]$$

which is given over each $U \in C$ by $\overline{W}(G(U))$.

Proof. By theorem 3.6.113 every ∞ -group is the loop space object of a pointed connected object. By prop. 3.6.83 every such is presented by a presheaf X of reduced simplicial sets. By the simplicial looping/delooping Quillen equivalence, theorem 3.6.126, the presheaf

$$\overline{WLX} \in [C^{\text{op}}, \mathbf{sSet}]_{\text{proj}}$$

is weakly equivalent to the simplicial presheaf X . From this the statement follows with corollary 3.6.129, combined with prop. 2.3.13, which together say that the presheaf LX of simplicial groups presents the given ∞ -group. \square

Remark 3.6.132. We may read this as saying that every ∞ -group may be *strictified*.

Example 3.6.133. Every 2-group in \mathbf{H} (1-truncated group object) has a presentation by a crossed module, def. 1.2.74, in simplicial presheaves.

3.6.9 Cohomology

There is an intrinsic notion of *cohomology* in every ∞ -topos. It is the joint generalization of the definition of cohomology in \mathbf{Top} in terms of maps into classifying spaces and of *sheaf cohomology* over any site of definition of the ∞ -topos.

For the case of abelian coefficients, as discussed in 2.2.6, this perspective of (sheaf) cohomology as the cohomology intrinsic to an ∞ -topos is essentially made explicit already in [Br73]. In more modern language analogous discussion is in section 7.2.2 of [L-Topos].

Here we review central concepts and discuss further aspects that will be needed later on.

3.6.9.1 General abstract

Definition 3.6.134. For $X, A \in \mathbf{H}$ two objects, we say that

$$H(X, A) := \pi_0 \mathbf{H}(X, A)$$

is the *cohomology set* of X with coefficients in A . If $A = G$ is an ∞ -group we write

$$H^1(X, G) := \pi_0 \mathbf{H}(X, \mathbf{B}G)$$

for cohomology with coefficients in its delooping. Generally, if $K \in \mathbf{H}$ has a p -fold delooping for some $p \in \mathbb{N}$, we write

$$H^p(X, K) := \pi_0 \mathbf{H}(X, \mathbf{B}^p K).$$

In the context of cohomology on X with coefficients in A we say that

- the hom-space $\mathbf{H}(X, A)$ is the *cocycle ∞ -groupoid*;
- a morphism $g : X \rightarrow A$ is a *cocycle*;
- a 2-morphism $g \Rightarrow h$ is a *coboundary* between cocycles.
- a morphism $c : A \rightarrow B$ represents the *characteristic class*

$$[c] : H(-, A) \rightarrow H(-, B).$$

Remark 3.6.135. Traditionally attention is often concentrated on the case that $K \in \tau_0 \mathbf{Grp}(\mathbf{H})$ is an abelian 0-truncated group object and $A := \mathbf{B}^p K$ is the Eilenber-MacLane object with K in degree p . The corresponding cohomology $H^p(-, K) \simeq \pi_0 \mathbf{H}(-, \mathbf{B}^p K)$ is sometimes called *ordinary cohomology* with coefficients in K , to distinguish it from the generalizations obtained by allowing more general K , which traditionally go by the term *hypercohomology* (if K is not necessarily concentrated in a single degree but is still an abelian ∞ -group, def. 3.6.117) and more generally *nonabelian cohomology* (if A is allowed to be any homotopy type).

Below in 3.6.10 we discuss the notion of an ∞ -group G acting on a space X and the corresponding (homotopy) quotient $X//G$. Then we say

Definition 3.6.136. The cohomology of $X//G$ is the *G -equivariant cohomology* of X with respect to the given action. .

Remark 3.6.137. There is also a notion of cohomology in the *petit* ∞ -topos of $X \in \mathbf{H}$, the slice of \mathbf{H} over X

$$\mathcal{X} := \mathbf{H}/_X.$$

This is canonically equipped with the étale geometric morphism, prop. 3.6.13

$$(X! \dashv X^* \dashv X_*) : \mathbf{H}/X \begin{array}{c} \xrightarrow{X!} \\ \xleftarrow{X^*} \\ \xrightarrow{X_*} \end{array} \mathbf{H},$$

where $X_!$ simply forgets the morphism to X and where $X^* = X \times (-)$ forms the product with X . Accordingly $X^*(\ast_{\mathbf{H}}) \simeq \ast_{\mathcal{X}} =: X$ and $X_!(\ast_{\mathcal{X}}) = X \in \mathbf{H}$. Therefore cohomology over X with coefficients of the form X^*A is equivalently the cohomology in \mathbf{H} of X with coefficients in A :

$$\mathcal{X}(X, X^*A) \simeq \mathbf{H}(X, A).$$

For a general coefficient object $A \in \mathcal{X}$ the A -cohomology over X in \mathcal{X} is a *twisted* cohomology of X in \mathbf{H} , discussed below in 3.6.12.

Typically one thinks of a morphism $A \rightarrow B$ in \mathbf{H} as presenting a *characteristic class* of A if B is “simpler” than A , notably if B is an Eilenberg-MacLane object $B = \mathbf{B}^n K$ for K a 0-truncated abelian group in \mathbf{H} . In this case the characteristic class may be regarded as being in the degree- n K -cohomology of A

$$[c] \in H^n(A, K).$$

Definition 3.6.138. For every morphism $c : \mathbf{B}G \rightarrow \mathbf{B}H \in \mathbf{H}$ define the *long fiber sequence to the left*

$$\cdots \rightarrow \Omega G \rightarrow \Omega H \rightarrow F \rightarrow G \rightarrow H \rightarrow \mathbf{B}F \rightarrow \mathbf{B}G \xrightarrow{c} \mathbf{B}H$$

to be given by the consecutive pasting diagrams of ∞ -pullbacks

$$\begin{array}{ccccccc} & & \cdots & & \cdots & & \cdots \\ & & \vdots & & \vdots & & \vdots \\ \cdots & \rightarrow & F & \rightarrow & G & \rightarrow & * \\ & & \downarrow & & \downarrow & & \downarrow \\ & & * & \rightarrow & H & \rightarrow & \mathbf{B}F \rightarrow * \\ & & & & \downarrow & & \downarrow \\ & & & & * & \rightarrow & \mathbf{B}G \xrightarrow{c} \mathbf{B}H \end{array}$$

Proposition 3.6.139. *This is well-defined, in that the objects in the fiber sequence are indeed as indicated.*

Proof. Repeatedly apply the pasting law 2.3.2 and definition 3.6.111. □

Proposition 3.6.140. 1. *The long fiber sequence to the left of $c : \mathbf{B}G \rightarrow \mathbf{B}H$ becomes constant on the point after n iterations if H is n -truncated.*

2. *For every object $X \in \mathbf{H}$ we have a long exact sequence of pointed cohomology sets*

$$\cdots \rightarrow H^0(X, G) \rightarrow H^0(X, H) \rightarrow H^1(X, F) \rightarrow H^1(X, G) \rightarrow H^1(X, H).$$

Proof. The first statement follows from the observation that a loop space object $\Omega_x A$ is a fiber of the free loop space object $\mathcal{L}A$ and that this may equivalently be computed by the ∞ -powering A^{S^1} , where $S^1 \in \mathbf{Top} \simeq \infty\mathbf{Grpd}$ is the circle.

The second statement follows by observing that the ∞ -hom-functor $\mathbf{H}(X, -)$ preserves all ∞ -limits, so that we have ∞ -pullbacks

$$\begin{array}{ccc} \mathbf{H}(X, F) & \longrightarrow & * \\ \downarrow & & \downarrow \\ \mathbf{H}(X, G) & \longrightarrow & \mathbf{H}(X, H) \end{array}$$

etc. in $\infty\mathbf{Grpd}$ at each stage of the fiber sequence. The statement then follows with the familiar long exact sequence for homotopy groups in $\mathbf{Top} \simeq \infty\mathbf{Grpd}$. □

Remark 3.6.141. To every cocycle $g : X \rightarrow \mathbf{BG}$ is canonically associated its homotopy fiber $P \rightarrow X$, the ∞ -pullback

$$\begin{array}{ccc} P & \longrightarrow & * \\ \downarrow & & \downarrow \\ X & \xrightarrow{g} & \mathbf{BG} . \end{array}$$

We discuss below in 3.6.10 that such P canonically has the structure of a G -principal ∞ -bundle and that \mathbf{BG} is the fine moduli space – the moduli ∞ -stack – for G -principal ∞ -bundles.

Proposition 3.6.142 (Mayer-Vietoris fiber sequence). *Let \mathbf{H} be an ∞ -topos with a 1-site of definition (for instance an ∞ -cohesive site as in def. 3.4.17) and let B be an ∞ -group object in \mathbf{H} . Then for any two morphisms $f : X \rightarrow B$ and $g : Y \rightarrow B$ the ∞ -pullback $X \times_B Y$ is equivalently the ∞ -pullback*

$$\begin{array}{ccc} X \times_B Y & \longrightarrow & * \\ \downarrow & & \downarrow \\ X \times Y & \xrightarrow{f \cdot g^{-1}} & B \end{array} ,$$

where the bottom morphism is the composite

$$f \cdot g^{-1} : X \times Y \xrightarrow{(f,g)} B \times B \xrightarrow{(\text{id}, (-)^{-1})} B \times B \longrightarrow B$$

of the pair (f, g) with the morphism that inverts the second factor and the morphism that exhibits the group product on B .

We have then a fiber sequence that starts out as

$$\dots \longrightarrow \Omega B \longrightarrow X \times_B Y \longrightarrow X \times Y \xrightarrow{f \cdot g^{-1}} B .$$

Proof. By prop 3.6.131 there is a presheaf of simplicial groups presenting B over the site C , which we shall denote by the same symbol, $B \in [C^{\text{op}}, \text{sGrp}] \rightarrow [C^{\text{op}}, \text{sSet}]$. In terms of this the morphism $- : B \times B \rightarrow B$ is, objectwise over $U \in C$, given by the simplicial morphism $-_U : B(U) \times B(U) \rightarrow B(U)$ that sends k -cells $(a, b) : \Delta[k] \rightarrow B(U) \times B(U)$ to $a \cdot b^{-1}$, using the degreewise group structure.

We observe first that this morphism is objectwise a Kan fibration and hence a fibration in $[S^{\text{op}}, \text{sSet}]_{\text{proj}}$. To see this, let

$$\begin{array}{ccc} \Lambda[k]_i & \xrightarrow{(ha, hb)} & B(U) \times B(U) \\ \downarrow j & & \downarrow - \\ \Delta[k] & \xrightarrow{\sigma} & B(U) \end{array}$$

be a lifting problem. Since $B(U)$, being the simplicial set underlying a simplicial group, is a Kan complex, there is a filler $b : \Delta[k] \rightarrow B(U)$ of the horn hb . Define then a k -cell

$$a := \sigma \cdot b .$$

This is a filler of ha , since the face maps are group homomorphisms:

$$\begin{aligned} \delta_l a &= \delta_l(\sigma \cdot b) \\ &= \delta_l(\sigma) \cdot \delta_l(b) \\ &= \delta_l(\sigma) \cdot (hb)_l \\ &= (ha)_l \end{aligned}$$

So we have a filler

$$\begin{array}{ccc} \Lambda[k]_i & \xrightarrow{(ha, hb)} & B(U) \times B(U) \\ \downarrow j & \nearrow (a, b) & \downarrow - \\ \Delta[k] & \xrightarrow{\sigma} & B(U) \end{array}$$

Observe then that there is a pullback diagram of simplicial presheaves

$$\begin{array}{ccc} B & \longrightarrow & * \\ \downarrow \Delta_B & & \downarrow e \\ B \times B & \xrightarrow{-} & B \end{array},$$

where the left morphism is the diagonal on B and where the right morphism picks the neutral element in B . Since, by the above, the bottom morphism is a fibration, this presents a homotopy pullback.

Next, by the *factorization lemma*, lemma 2.3.9, and using prop. 2.3.13, the homotopy pullback of f along g is presented by the ordinary pullback of simplicial presheaves

$$\begin{array}{ccc} Q & \longrightarrow & B^{\Delta[0]} \\ \downarrow & & \downarrow \\ X \times Y & \xrightarrow{(f, g)} & B \times B \end{array},$$

where the right morphism is endpoint evaluation out of the canonical path object of B , which is a fibration replacement of the diagonal Δ_B . Therefore this presents an ∞ -pullback

$$\begin{array}{ccc} Q & \longrightarrow & B \\ \downarrow & & \downarrow \Delta_B \\ X \times Y & \xrightarrow{(f, g)} & B \times B \end{array}.$$

Now by the pasting law, prop. 2.3.2, Q is also an ∞ -pullback for the total outer diagram in

$$\begin{array}{ccccc} Q & \longrightarrow & B & \longrightarrow & * \\ \downarrow & & \downarrow \Delta_B & & \downarrow e \\ X \times Y & \xrightarrow{(f, g)} & B \times B & \xrightarrow{-} & B \\ & \searrow & \text{---} & \searrow & \\ & & f \cdot g^{-1} & & \end{array}$$

□

3.6.9.2 Presentations We discuss explicit presentations of cocycles, cohomology classes and fiber sequences in an ∞ -topos.

3.6.9.2.1 Cocycle ∞ -groupoids and cohomology classes We discuss a useful presentation of cocycle ∞ -groupoids and of cohomology classes by a construction that exists when the ambient ∞ -topos is presented by a category with weak equivalences that is equipped with the structure of a *category of fibrant objects* [Br73].

Definition 3.6.143 (Brown). A *category of fibrant objects* is a category equipped with two distinguished classes of morphisms, called *fibrations* and *weak equivalences*, such that

1. the category has a terminal object $*$ and finite products;
2. fibrations and weak equivalences form subcategories that contain all isomorphisms; weak equivalences moreover satisfy the 2-out-of-3 property;
3. for any object B the map $B \rightarrow *$ is a fibration;
4. the classes of fibrations and of *acyclic fibrations* (the fibrations that are also weak equivalences) are stable under pullback. That means: given a diagram $A \xrightarrow{g} C \xleftarrow{f} B$ where f is a (acyclic) fibration then the pullback $A \times_C B$ exists and the morphism $A \times_C B \rightarrow A$ is again a (acyclic) fibration.
5. For every object B there is a path object B^I , i.e. a factorization of the diagonal $\Delta: B \rightarrow B \times B$ into

$$B \xrightarrow{\simeq} B^I \twoheadrightarrow B \times B$$

such that left map is weak equivalence and the right map a fibration. We assume here moreover for simplicity that this B^I can be chosen functorial in B .

Given a category of fibrant objects, we will denote the class of weak equivalence by W and the class of fibrations by F .

Examples 3.6.144. We have the following well known examples of categories of fibrant objects.

- For any model category (with functorial factorization) the full subcategory of fibrant objects is a category of fibrant objects.
- The category of stalkwise Kan simplicial presheaves on any site with enough points. In this case the fibrations are the stalkwise fibrations and the weak equivalences are the stalkwise weak equivalences.

Remark 3.6.145. Notice that (over a non-trivial site) the second example above is *not* a special case of the first: while there are model structures on categories of simplicial presheaves whose weak equivalences are the stalkwise weak equivalences, their fibrations (even between fibrant objects) are much more restricted than just being stalkwise fibrations.

Theorem 3.6.146. Let the ∞ -category \mathbf{H} be presented by a category with weak equivalences (\mathcal{C}, W) that carries a compatible structure of a category of fibrant objects, def. 3.6.143.

Then for X, A and two objects in \mathcal{C} , presenting two objects in \mathbf{H} , the ∞ -groupoid $\mathbf{H}(X, A)$ is presented in $\mathbf{sSet}_{\text{Quillen}}$ by the nerve of the category whose

- objects are spans (cocycles / ∞ -anafunctors)

$$X \xleftarrow{\simeq} \hat{X} \xrightarrow{g} A$$

in \mathcal{C} ;

- morphisms $f : (\hat{X}, g) \rightarrow (\hat{X}', g')$ are given by morphisms $f : \hat{X} \rightarrow \hat{X}'$ in \mathcal{C} such that the diagram

$$\begin{array}{ccccc} & & \hat{X} & & \\ & \simeq & \swarrow & g & \\ X & & & & A \\ & \simeq & \searrow & f & \\ & & \hat{X}' & g' & \end{array}$$

commutes.

This appears for instance as prop. 3.23 in [Ci10].

Example 3.6.147. By the discussion in 2.2.3, if \mathbf{H} has a 1-site of definition C with enough 1-topos points, then it is presented by the category $\mathrm{Sh}(C)^{\Delta^{\mathrm{op}}}$ of simplicial sheaves on C with weak equivalences the stalkwise weak equivalences of simplicial sets, and equivalently by its full subcategory of stalkwise Kan fibrant simplicial sheaves. With the local fibrations, def. 2.2.13 as fibrations, this is a category of fibrant objects. So in this case the cocycle ∞ -groupoid $\mathbf{H}(X, A)$ is presented by the Kan fibrant replacement of the category whose objects are spans

$$X \xleftarrow{\simeq} \hat{X} \xrightarrow{g} A$$

for $\hat{X} \rightarrow X$ a stalkwise acyclic Kan fibration, and whose morphisms are as above.

3.6.9.2.2 Fiber sequences We discuss explicit presentations of certain fiber sequences, def. 3.6.138, in an ∞ -topos.

Proposition 3.6.148. *Let $A \rightarrow \hat{G} \rightarrow G$ be a central extension of (ordinary) groups. Then there is a long fiber sequence in $\infty\mathrm{Grpd}$ of the form*

$$A \longrightarrow \hat{G} \longrightarrow G \xrightarrow{\Omega^c} \mathbf{B}A \longrightarrow \mathbf{B}\hat{G} \longrightarrow \mathbf{B}G \xrightarrow{c} \mathbf{B}^2A ,$$

where the connecting homomorphism is presented by the correspondence of crossed modules, def. 1.2.74, given by

$$(1 \rightarrow G) \xleftarrow{\simeq} (A \rightarrow \hat{G}) \longrightarrow (A \rightarrow 1) .$$

Here in the middle appears the crossed module defined by the central extension, def. 1.2.81.

3.6.10 Principal bundles

For G an ∞ -group object in a cohesive ∞ -topos \mathbf{H} and $\mathbf{B}G$ its delooping in \mathbf{H} , as discussed in 3.6.8, the cohomology over an object X with coefficients in $\mathbf{B}G$, as in 3.6.9, classifies maps $P \rightarrow X$ that are equipped with a G -action that is *principal*. We discuss here these G -*principal* ∞ -*bundles*.

3.6.10.1 Introduction and survey We give an exposition of some central ideas and phenomena of higher principal bundles, discussed in detail below.

This section draws from [NSS12a].

Let G be a topological group, or Lie group or some similar such object. The traditional definition of G -*principal bundle* is the following: there is a map

$$P \rightarrow X := P/G$$

which is the quotient projection induced by a *free* action

$$\rho : P \times G \rightarrow P$$

of G on a space (or manifold, depending on context) P , such that there is a cover $U \rightarrow X$ over which the quotient projection is isomorphic to the trivial one $U \times G \rightarrow U$.

In higher geometry, if G is a topological or smooth ∞ -group, the quotient projection must be replaced by the ∞ -quotient (homotopy quotient) projection

$$P \rightarrow X := P//G$$

for the action of G on a topological or smooth ∞ -groupoid (or ∞ -stack) P . It is a remarkable fact that this single condition on the map $P \rightarrow X$ already implies that G acts freely on P and that $P \rightarrow X$ is locally

trivial, when the latter notions are understood in the context of higher geometry. We will therefore define a G -principal ∞ -bundle to be such a map $P \rightarrow X$.

As motivation for this, notice that if a Lie group G acts properly, but not freely, then the quotient $P \rightarrow X := P/G$ differs from the homotopy quotient. Specifically, if precisely the subgroup $G_{\text{stab}} \hookrightarrow G$ acts trivially, then the homotopy quotient is instead the *quotient stack* $X//G_{\text{stab}}$ (sometimes written $[X//G_{\text{stab}}]$, which is an orbifold if G_{stab} is finite). The ordinary quotient coincides with the homotopy quotient if and only if the stabilizer subgroup G_{stab} is trivial, and hence if and only if the action of G is free.

Conversely this means that in the context of higher geometry a non-free action may also be principal: with respect not to a base space, but with respect to a base groupoid/stack. In the example just discussed, we have that the projection $P \rightarrow X//G_{\text{stab}}$ exhibits P as a G -principal bundle over the action groupoid $P//G \simeq X//G_{\text{stab}}$. For instance if $P = V$ is a vector space equipped with a G -representation, then $V \rightarrow V//G$ is a G -principal bundle over a groupoid/stack. In other words, the traditional requirement of freeness in a principal action is not so much a characterization of principality as such, as rather a condition that ensures that the base of a principal action is a 0-truncated object in higher geometry.

Beyond this specific class of 0-truncated examples, this means that we have the following noteworthy general statement: in higher geometry *every* ∞ -action is principal with respect to *some* base, namely with respect to its ∞ -quotient. In this sense the notion of principal bundles is (even) more fundamental to higher geometry than it is to ordinary geometry. Also, several constructions in ordinary geometry that are traditionally thought of as conceptually different from the notion of principality turn out to be special cases of principality in higher geometry. For instance a central extension of groups $A \rightarrow \hat{G} \rightarrow G$ turns out to be equivalently a higher principal bundle, namely a $\mathbf{B}A$ -principal 2-bundle of moduli stacks $\mathbf{B}\hat{G} \rightarrow \mathbf{B}G$. Following this through, one finds that the topics of principal ∞ -bundles, of ∞ -group extensions (3.6.14), of ∞ -representations (3.6.13), and of ∞ -group cohomology are all different aspects of just one single concept in higher geometry.

More is true: in the context of an ∞ -topos every ∞ -quotient projection of an ∞ -group action is locally trivial, with respect to the canonical intrinsic notion of cover, hence of locality. Therefore also the condition of local triviality in the classical definition of principality becomes automatic. This is a direct consequence of the third ∞ -Giraud axiom, Definition 2.2.2 that “all ∞ -quotients are effective”. This means that the projection map $P \rightarrow P//G$ is always a cover (an *effective epimorphism*) and so, since every G -principal ∞ -bundle trivializes over itself, it exhibits a local trivialization of itself; even without explicitly requiring it to be locally trivial.

As before, this means that the local triviality clause appearing in the traditional definition of principal bundles is not so much a characteristic of principality as such, as rather a condition that ensures that a given quotient taken in a category of geometric spaces coincides with the “correct” quotient obtained when regarding the situation in the ambient ∞ -topos.

Another direct consequence of the ∞ -Giraud axioms is the equivalence of the definition of principal bundles as quotient maps, which we discussed so far, with the other main definition of principality: the condition that the “shear map” $(\text{id}, \rho) : P \times G \rightarrow P \times_X P$ is an equivalence. It is immediate to verify in traditional 1-categorical contexts that this is equivalent to the action being properly free and exhibiting X as its quotient (we discuss this in detail in [NSS12c]). Simple as this is, one may observe, in view of the above discussion, that the shear map being an equivalence is much more fundamental even: notice that $P \times G$ is the first stage of the *action groupoid object* $P//G$, and that $P \times_X P$ is the first stage of the *Čech nerve groupoid object* $\check{C}(P \rightarrow X)$ of the corresponding quotient map. Accordingly, the shear map equivalence is the first stage in the equivalence of groupoid objects in the ∞ -topos

$$P//G \simeq \check{C}(P \rightarrow X).$$

This equivalence is just the explicit statement of the fact mentioned before: the groupoid object $P//G$ is effective – as is any groupoid object in an ∞ -topos – and, equivalently, its principal ∞ -bundle map $P \rightarrow X$ is an effective epimorphism.

Fairly directly from this fact, finally, springs the classification theorem of principal ∞ -bundles. For we have a canonical morphism of groupoid objects $P//G \rightarrow *//G$ induced by the terminal map $P \rightarrow *$. By the

∞ -Giraud theorem the ∞ -colimit over this sequence of morphisms of groupoid objects is a G -cocycle on X (Definition 3.6.134) canonically induced by P :

$$\varinjlim (\check{C}(P \rightarrow X)_\bullet \simeq (P//G)_\bullet \rightarrow (*//G)_\bullet) = (X \rightarrow \mathbf{B}G) \in \mathbf{H}(X, \mathbf{B}G).$$

Conversely, from any such G -cocycle one finds that one obtains a G -principal ∞ -bundle simply by forming its ∞ -fiber: the ∞ -pullback of the point inclusion $* \rightarrow \mathbf{B}G$. We show in [NSS12b] that in presentations of the ∞ -topos theory by 1-categorical tools, the computation of this homotopy fiber is *presented* by the ordinary pullback of a big resolution of the point, which turns out to be nothing but the universal G -principal bundle. This appearance of the universal ∞ -bundle as just a resolution of the point inclusion may be understood in light of the above discussion as follows. The classical characterization of the universal G -principal bundle $\mathbf{E}G$ is as a space that is homotopy equivalent to the point and equipped with a *free* G -action. But by the above, freeness of the action is an artefact of 0-truncation and not a characteristic of principality in higher geometry. Accordingly, in higher geometry the universal G -principal ∞ -bundle for any ∞ -group G may be taken to *be* the point, equipped with the trivial (maximally non-free) G -action. As such, it is a bundle not over the classifying *space* BG of G , but over the full moduli ∞ -stack $\mathbf{B}G$.

This way we have natural assignments of G -principal ∞ -bundles to cocycles in G -nonabelian cohomology, and vice versa. We find (see Theorem 3.6.167 below) that precisely the second ∞ -Giraud axiom of Definition 2.2.2, namely the fact that in an ∞ -topos ∞ -colimits are preserved by ∞ -pullback, implies that these constructions constitute an equivalence of ∞ -groupoids, hence that G -principal ∞ -bundles are classified by G -cohomology.

The following table summarizes the relation between ∞ -bundle theory and the ∞ -Giraud axioms as indicated above, and as proven in the following section.

∞ -Giraud axioms	principal ∞ -bundle theory
quotients are effective	every ∞ -quotient $P \rightarrow X := P//G$ is principal
colimits are preserved by pullback	G -principal ∞ -bundles are classified by $\mathbf{H}(X, \mathbf{B}G)$

3.6.10.2 Definition and classification We discuss the general definition and the central classification theorem of principal ∞ -bundles.

This section draws from [NSS12a].

Definition 3.6.149. For $G \in \text{Grp}(\mathbf{H})$ a group object, we say a G -action on an object $P \in \mathbf{H}$ is a groupoid object $P//G$ (Definition 3.6.88) of the form

$$\cdots \rightrightarrows P \times G \times G \rightrightarrows P \times G \xrightarrow[\substack{\rho:=d_0 \\ d_1}]{\substack{\rho:=d_0 \\ d_1}} P$$

such that $d_1 : P \times G \rightarrow P$ is the projection, and such that the degreewise projections $P \times G^n \rightarrow G^n$ constitute a morphism of groupoid objects

$$\begin{array}{ccccccc} \cdots & \rightrightarrows & P \times G \times G & \rightrightarrows & P \times G & \rightrightarrows & P \\ & & \downarrow & & \downarrow & & \downarrow \\ \cdots & \rightrightarrows & G \times G & \rightrightarrows & G & \rightrightarrows & * \end{array}$$

where the lower simplicial object exhibits G as a groupoid object over $*$.

With convenient abuse of notation we also write

$$P//G := \varinjlim(P \times G^{\times \bullet}) \in \mathbf{H}$$

for the corresponding ∞ -colimit object, the ∞ -quotient of this action.

Write

$$G\text{Action}(\mathbf{H}) \hookrightarrow \text{Grpd}(\mathbf{H})_{/(*/G)}$$

for the full sub- ∞ -category of groupoid objects over $*/G$ on those that are G -actions.

Remark 3.6.150. The remaining face map d_0

$$\rho := d_0 : P \times G \rightarrow P$$

is the action itself.

Remark 3.6.151. Using this notation in Proposition 3.6.118 we have

$$\mathbf{BG} \simeq */G.$$

We list examples of ∞ -actions below as Example 3.6.213. This is most conveniently done after establishing the theory of principal ∞ -actions, to which we now turn.

Definition 3.6.152. Let $G \in \infty\text{Grp}(\mathbf{H})$ be an ∞ -group and let X be an object of \mathbf{H} . A G -principal ∞ -bundle over X (or G -torsor over X) is

1. a morphism $P \rightarrow X$ in \mathbf{H} ;
2. together with a G -action on P ;

such that $P \rightarrow X$ is the colimiting cocone exhibiting the quotient map $X \simeq P//G$ (Definition 3.6.149).

A *morphism* of G -principal ∞ -bundles over X is a morphism of G -actions that fixes X ; the ∞ -category of G -principal ∞ -bundles over X is the homotopy fiber of ∞ -categories

$$G\text{Bund}(X) := G\text{Action}(\mathbf{H}) \times_{\mathbf{H}} \{X\}$$

over X of the quotient map

$$G\text{Action}(\mathbf{H}) \hookrightarrow \text{Grpd}(\mathbf{H})_{/(*/G)} \longrightarrow \text{Grpd}(\mathbf{H}) \xrightarrow{\varinjlim} \mathbf{H}.$$

Remark 3.6.153. By the third ∞ -Giraud axiom (Definition 2.2.2) this means in particular that a G -principal ∞ -bundle $P \rightarrow X$ is an effective epimorphism in \mathbf{H} .

Remark 3.6.154. Even though $G\text{Bund}(X)$ is by definition a priori an ∞ -category, Proposition 3.6.166 below says that in fact it happens to be ∞ -groupoid: all its morphisms are invertible.

Proposition 3.6.155. A G -principal ∞ -bundle $P \rightarrow X$ satisfies the principality condition: the canonical morphism

$$(\rho, p_1) : P \times G \xrightarrow{\simeq} P \times_X P$$

is an equivalence, where ρ is the G -action.

Proof. By the third ∞ -Giraud axiom (Definition 2.2.2) the groupoid object $P//G$ is effective, which means that it is equivalent to the Čech nerve of $P \rightarrow X$. In first degree this implies a canonical equivalence $P \times G \rightarrow P \times_X P$. Since the two face maps $d_0, d_1 : P \times_X P \rightarrow P$ in the Čech nerve are simply the projections out of the fiber product, it follows that the two components of this canonical equivalence are the two face maps $d_0, d_1 : P \times G \rightarrow P$ of $P//G$. By definition, these are the projection onto the first factor and the action itself. \square

Proposition 3.6.156. For $g : X \rightarrow \mathbf{B}G$ any morphism, its homotopy fiber $P \rightarrow X$ canonically carries the structure of a G -principal ∞ -bundle over X .

Proof. That $P \rightarrow X$ is the fiber of $g : X \rightarrow \mathbf{B}G$ means that we have an ∞ -pullback diagram

$$\begin{array}{ccc} P & \longrightarrow & * \\ \downarrow & & \downarrow \\ X & \xrightarrow{g} & \mathbf{B}G. \end{array}$$

By the pasting law for ∞ -pullbacks, Proposition 2.3.2, this induces a compound diagram

$$\begin{array}{ccccccc} \cdots & \rightrightarrows & P \times G \times G & \rightrightarrows & P \times G & \rightrightarrows & P \longrightarrow X \\ & & \downarrow & & \downarrow & & \downarrow \\ \cdots & \rightrightarrows & G \times G & \rightrightarrows & G & \rightrightarrows & * \longrightarrow \mathbf{B}G \end{array}$$

where each square and each composite rectangle is an ∞ -pullback. This exhibits the G -action on P . Since $* \rightarrow \mathbf{B}G$ is an effective epimorphism, so is its ∞ -pullback $P \rightarrow X$. Since, by the ∞ -Giraud theorem, ∞ -colimits are preserved by ∞ -pullbacks we have that $P \rightarrow X$ exhibits the ∞ -colimit $X \simeq P//G$. \square

Lemma 3.6.157. For $P \rightarrow X$ a G -principal ∞ -bundle obtained as in Proposition 3.6.156, and for $x : * \rightarrow X$ any point of X , we have a canonical equivalence

$$x^*P \xrightarrow{\simeq} G$$

between the fiber x^*P and the ∞ -group object G .

Proof. This follows from the pasting law for ∞ -pullbacks, which gives the diagram

$$\begin{array}{ccccc} G & \longrightarrow & P & \longrightarrow & * \\ \downarrow & & \downarrow & & \downarrow \\ * & \xrightarrow{x} & X & \xrightarrow{g} & \mathbf{B}G \end{array}$$

in which both squares as well as the total rectangle are ∞ -pullbacks. \square

Definition 3.6.158. The *trivial* G -principal ∞ -bundle $(P \rightarrow X) \simeq (X \times G \rightarrow X)$ is, up to equivalence, the one obtained via Proposition 3.6.156 from the morphism $X \rightarrow * \rightarrow \mathbf{B}G$.

Observation 3.6.159. For $P \rightarrow X$ a G -principal ∞ -bundle and $Y \rightarrow X$ any morphism, the ∞ -pullback $Y \times_X P$ naturally inherits the structure of a G -principal ∞ -bundle.

Proof. This uses the same kind of argument as in Proposition 3.6.156 (which is the special case of the pullback of what we will see is the universal G -principal ∞ -bundle $* \rightarrow \mathbf{B}G$ below in Proposition 3.6.163). \square

Definition 3.6.160. A G -principal ∞ -bundle $P \rightarrow X$ is called *locally trivial* if there exists an effective epimorphism $U \twoheadrightarrow X$ and an equivalence of G -principal ∞ -bundles

$$U \times_X P \simeq U \times G$$

from the pullback of P (Observation 3.6.159) to the trivial G -principal ∞ -bundle over U (Definition 3.6.158).

Proposition 3.6.161. *Every G -principal ∞ -bundle is locally trivial.*

Proof. For $P \rightarrow X$ a G -principal ∞ -bundle, it is, by Remark 3.6.153, itself an effective epimorphism. The pullback of the G -bundle to its own total space along this morphism is trivial, by the principality condition (Proposition 3.6.155). Hence setting $U := P$ proves the claim. \square

Remark 3.6.162. This means that every G -principal ∞ -bundle is in particular a G -fiber ∞ -bundle (in the evident sense of Definition 3.6.201 below). But not every G -fiber bundle is G -principal, since the local trivialization of a fiber bundle need not respect the G -action.

Proposition 3.6.163. *For every G -principal ∞ -bundle $P \rightarrow X$ the square*

$$\begin{array}{ccc}
 P & \longrightarrow & * \\
 \downarrow & & \downarrow \\
 X \simeq \varinjlim_n (P \times G^{\times n}) & \longrightarrow & \varinjlim_n G^{\times n} \simeq \mathbf{B}G
 \end{array}$$

is an ∞ -pullback diagram.

Proof. Let $U \rightarrow X$ be an effective epimorphism such that $P \rightarrow X$ pulled back to U becomes the trivial G -principal ∞ -bundle. By Proposition 3.6.161 this exists. By definition of morphism of G -actions and by functoriality of the ∞ -colimit, this induces a morphism in $\mathbf{H}^{\Delta[1]}_{/(* \rightarrow \mathbf{B}G)}$ corresponding to the diagram

$$\begin{array}{ccc}
 U \times G \longrightarrow P \longrightarrow * \\
 \downarrow \quad \downarrow \quad \downarrow \text{pt} \\
 U \longrightarrow X \longrightarrow \mathbf{B}G
 \end{array}
 \simeq
 \begin{array}{ccc}
 U \times G \longrightarrow * \\
 \downarrow \quad \downarrow \text{pt} \\
 U \longrightarrow * \xrightarrow{\text{pt}} \mathbf{B}G
 \end{array}$$

in \mathbf{H} . By assumption, in this diagram the outer rectangles and the square on the very left are ∞ -pullbacks. We need to show that the right square on the left is also an ∞ -pullback.

Since $U \rightarrow X$ is an effective epimorphism by assumption, and since these are stable under ∞ -pullback, $U \times G \rightarrow P$ is also an effective epimorphism, as indicated. This means that

$$P \simeq \varinjlim_n (U \times G)^{\times_P^{n+1}}.$$

We claim that for all $n \in \mathbb{N}$ the fiber products in the colimit on the right are naturally equivalent to $(U^{\times_x^{n+1}}) \times G$. For $n = 0$ this is clearly true. Assume then by induction that it holds for some $n \in \mathbb{N}$. Then with the pasting law (Proposition 2.3.2) we find an ∞ -pullback diagram of the form

$$\begin{array}{ccccc}
 (U^{\times_x^{n+1}}) \times G & \simeq & (U \times G)^{\times_P^{n+1}} & \longrightarrow & (U \times G)^{\times_P^n} \simeq (U^{\times_x^n}) \times G \\
 \downarrow & & \downarrow & & \downarrow \\
 U \times G & \longrightarrow & P & & \\
 \downarrow & & \downarrow & & \\
 U & \longrightarrow & X & &
 \end{array}$$

This completes the induction. With this the above expression for P becomes

$$\begin{aligned}
P &\simeq \varinjlim_n (U^{\times_X^{n+1}}) \times G \\
&\simeq \varinjlim_n \text{pt}^*(U^{\times_X^{n+1}}) \\
&\simeq \text{pt}^* \varinjlim_n (U^{\times_X^{n+1}}) \\
&\simeq \text{pt}^* X,
\end{aligned}$$

where we have used that by the second ∞ -Giraud axiom (Definition 2.2.2) we may take the ∞ -pullback out of the ∞ -colimit and where in the last step we used again the assumption that $U \rightarrow X$ is an effective epimorphism. \square

Example 3.6.164. The fiber sequence

$$\begin{array}{ccc}
G & \longrightarrow & * \\
& & \downarrow \\
& & \mathbf{B}G
\end{array}$$

which exhibits the delooping $\mathbf{B}G$ of G according to Theorem 3.6.113 is a G -principal ∞ -bundle over $\mathbf{B}G$, with *trivial* G -action on its total space $*$. Proposition 3.6.163 says that this is the *universal G -principal ∞ -bundle* in that every other one arises as an ∞ -pullback of this one. In particular, $\mathbf{B}G$ is a classifying object for G -principal ∞ -bundles.

Below in Theorem 3.6.252 this relation is strengthened: every *automorphism* of a G -principal ∞ -bundle, and in fact its full automorphism ∞ -group arises from pullback of the above universal G -principal ∞ -bundle: $\mathbf{B}G$ is the fine *moduli ∞ -stack* of G -principal ∞ -bundles.

The traditional definition of universal G -principal bundles in terms of contractible objects equipped with a free G -action has no intrinsic meaning in higher topos theory. Instead this appears in *presentations* of the general theory in model categories (or categories of fibrant objects) as *fibrant representatives* $\mathbf{E}G \rightarrow \mathbf{B}G$ of the above point inclusion. This we discuss in [NSS12b].

The main classification Theorem 3.6.167 below implies in particular that every morphism in $G\mathbf{Bund}(X)$ is an equivalence. For emphasis we note how this also follows directly:

Lemma 3.6.165. *Let \mathbf{H} be an ∞ -topos and let X be an object of \mathbf{H} . A morphism $f: A \rightarrow B$ in $\mathbf{H}/_X$ is an equivalence if and only if p^*f is an equivalence in $\mathbf{H}/_Y$ for any effective epimorphism $p: Y \rightarrow X$ in \mathbf{H} .*

Proof. It is clear, by functoriality, that p^*f is a weak equivalence if f is. Conversely, assume that p^*f is a weak equivalence. Since effective epimorphisms as well as equivalences are preserved by pullback we get a simplicial diagram of the form

$$\begin{array}{ccccc}
\cdots & \rightrightarrows & p^*A \times_A p^*A & \rightrightarrows & p^*A & \twoheadrightarrow & A \\
& & \downarrow \simeq & & \downarrow \simeq & & \downarrow f \\
\cdots & \rightrightarrows & p^*B \times_B p^*B & \rightrightarrows & p^*B & \twoheadrightarrow & B
\end{array}$$

where the rightmost horizontal morphisms are effective epimorphisms, as indicated. By definition of effective epimorphisms this exhibits f as an ∞ -colimit over equivalences, hence as an equivalence. \square

Proposition 3.6.166. *Every morphism between G -actions over X that are G -principal ∞ -bundles over X is an equivalence.*

Proof. Since a morphism of G -principal bundles $P_1 \rightarrow P_2$ is a morphism of Čech nerves that fixes their ∞ -colimit X , up to equivalence, and since $* \rightarrow \mathbf{B}G$ is an effective epimorphism, we are, by Proposition 3.6.163, in the situation of Lemma 3.6.165. \square

Theorem 3.6.167. *For all $X, \mathbf{B}G \in \mathbf{H}$ there is a natural equivalence of ∞ -groupoids*

$$GBund(X) \simeq \mathbf{H}(X, \mathbf{B}G)$$

which on vertices is the construction of Definition 3.6.156: a bundle $P \rightarrow X$ is mapped to a morphism $X \rightarrow \mathbf{B}G$ such that $P \rightarrow X \rightarrow \mathbf{B}G$ is a fiber sequence.

We therefore say

- $\mathbf{B}G$ is the *classifying object* or *moduli ∞ -stack* for G -principal ∞ -bundles;
- a morphism $c : X \rightarrow \mathbf{B}G$ is a *cocycle* for the corresponding G -principal ∞ -bundle and its class $[c] \in \mathbf{H}^1(X, G)$ is its *characteristic class*.

Proof. By Definitions 3.6.149 and 3.6.152 and using the refined statement of the third ∞ -Giraud axiom (Theorem 3.6.87), the ∞ -groupoid of G -principal ∞ -bundles over X is equivalent to the fiber over X of the sub- ∞ -category of the slice of the arrow ∞ -topos on those squares

$$\begin{array}{ccc} P & \longrightarrow & * \\ \downarrow & & \downarrow \\ X & \longrightarrow & \mathbf{B}G \end{array}$$

that exhibit $P \rightarrow X$ as a G -principal ∞ -bundle. By Proposition 3.6.156 and Proposition 3.6.163 these are the ∞ -pullback squares $\text{Cart}(\mathbf{H}^{\Delta[1]}_{/(* \rightarrow \mathbf{B}G)}) \hookrightarrow \mathbf{H}^{\Delta[1]}_{/(* \rightarrow \mathbf{B}G)}$, hence

$$GBund(X) \simeq \text{Cart}(\mathbf{H}^{\Delta[1]}_{/(* \rightarrow \mathbf{B}G)}) \times_{\mathbf{H}} \{X\}.$$

By the universality of the ∞ -pullback the morphisms between these are fully determined by their value on X , so that the above is equivalent to

$$\mathbf{H}_{/\mathbf{B}G} \times_{\mathbf{H}} \{X\}.$$

(For instance in terms of model categories: choose a model structure for \mathbf{H} in which all objects are cofibrant, choose a fibrant representative for $\mathbf{B}G$ and a fibration resolution $\mathbf{E}G \rightarrow \mathbf{B}G$ of the universal G -bundle. Then the slice model structure of the arrow model structure over this presents the slice in question and the statement follows from the analogous 1-categorical statement.) This finally is equivalent to

$$\mathbf{H}(X, \mathbf{B}G).$$

(For instance in terms of quasi-categories: the projection $\mathbf{H}_{/\mathbf{B}G} \rightarrow \mathbf{H}$ is a fibration by Proposition 2.1.2.1 and 4.2.1.6 in [L-Topos], hence the homotopy fiber $\mathbf{H}_{/\mathbf{B}G} \times_{\mathbf{H}} \{X\}$ is the ordinary fiber of quasi-categories. This is manifestly the $\text{Hom}_{\mathbf{H}}^R(X, \mathbf{B}G)$ from Proposition 1.2.2.3 of [L-Topos]. Finally, by Proposition 2.2.4.1 there, this is equivalent to $\mathbf{H}(X, \mathbf{B}G)$.) \square

Corollary 3.6.168. *Equivalence classes of G -principal ∞ -bundles over X are in natural bijection with the degree-1 G -cohomology of X :*

$$GBund(X)_{/\sim} \simeq H^1(X, G).$$

Proof. By Definition 3.6.134 this is the restriction of the equivalence $GBund(X) \simeq \mathbf{H}(X, \mathbf{B}G)$ to connected components. \square

3.6.10.3 Universal principal ∞ -bundles and the Borel construction By prop. 3.6.131 every ∞ -group in an ∞ -topos over an ∞ -cohesive site is presented by a (pre-)sheaf of simplicial groups, hence by a strict group object G in a 1-category of simplicial (pre-)sheaves. We have seen in 3.6.8.2 that for such a presentation the delooping $\mathbf{B}G$ is presented by $\bar{W}G$. By the above discussion in 3.6.10.2 the theory of G -principal ∞ -bundles is essentially that of homotopy fibers of morphisms into $\mathbf{B}G$, hence into $\bar{W}G$. By prop. 2.3.8 such homotopy fibers are computed as ordinary pullbacks of fibration resolutions of the point inclusion into $\bar{W}G$. Here we discuss these fibration resolutions. They turn out to be the classical *universal simplicial principal bundles* $WG \rightarrow \bar{W}G$.

This section draws from [NSS12b].

By prop. 3.6.131 every ∞ -group in an ∞ -topos over an ∞ -cohesive site is presented by a (pre-)sheaf of simplicial groups, hence by a strict group object G in a 1-category of simplicial (pre-)sheaves. We have seen in 3.6.8.2 that for such a presentation the delooping $\mathbf{B}G$ is presented by $\bar{W}G$. By the above discussion in 3.6.10.2 the theory of G -principal ∞ -bundles is essentially that of homotopy fibers of morphisms into $\mathbf{B}G$, hence into $\bar{W}G$. By prop. 2.3.8 such homotopy fibers are computed as ordinary pullbacks of fibration resolutions of the point inclusion into $\bar{W}G$. Here we discuss these fibration resolutions. They turn out to be the classical *universal simplicial principal bundles* $WG \rightarrow \bar{W}G$.

Let C be some site. We consider group objects in the category of simplicial presheaves $[C^{\text{op}}, \text{sSet}]$. Since sheafification preserves finite limits, all of the following statements hold verbatim also in the category $\text{Sh}(C)^{\Delta^{\text{op}}}$ of simplicial sheaves over C .

Definition 3.6.169. For G be a group object in $[C^{\text{op}}, \text{sSet}]$ and for $\rho : P \times G \rightarrow P$ a G -action, its *action groupoid object* is the simplicial object

$$P//G \in [\Delta^{\text{op}}, [C^{\text{op}}, \text{sSet}]]$$

whose value in degree n is

$$(P//G)_n := P \times G^{\times n} \in [C^{\text{op}}, \text{sSet}],$$

whose face maps are given by

$$d_i(p, g_1, \dots, g_n) = \begin{cases} (pg_1, g_2, \dots, g_n) & \text{if } i = 0, \\ (p, g_1, \dots, g_i g_{i+1}, \dots, g_n) & \text{if } 1 \leq i \leq n-1, \\ (p, g_1, \dots, g_{n-1}) & \text{if } i = n, \end{cases}$$

and whose degeneracy maps are given by

$$s_i(p, g_1, \dots, g_n) = (p, g_1, \dots, g_{i-1}, 1, g_i, \dots, g_n).$$

Definition 3.6.170. For $\rho : P \times G \rightarrow P$ an action, write

$$P/_h G := T(P//G) \in [C^{\text{op}}, \text{sSet}]$$

for the corresponding total simplicial object, def. 2.3.23.

Remark 3.6.171. According to corollary 2.3.27 the object $P/_h G$ presents the homotopy colimit over the simplicial object $P//G$. We say that $P/_h G$ is the *homotopy quotient* of P by the action of G .

Example 3.6.172. The unique trivial action of a group object G on the terminal object $*$ gives rise to a canonical action groupoid $*/_h G$. According to def. 3.6.122 we have

$$*/_h G = \bar{W}G.$$

The multiplication morphism $\cdot : G \times G \rightarrow G$ regarded as an action of G on itself gives rise to a canonical action groupoid $G//G$. The terminal morphism $G \rightarrow *$ induces a morphism of simplicial objects

$$G//G \rightarrow */_h G.$$

Defined this way $G//G$ carries a *left* G -action relative to this morphism. To stay with our convention that actions on bundles are from the right, we consider in the following instead the right action of G on itself given by

$$G \times G \xrightarrow{\sigma} G \times G \xrightarrow{((-)^{-1}, \text{id})} G \times G \xrightarrow{\cdot} G ,$$

where σ exchanges the two cartesian factors

$$(h, g) \mapsto g^{-1}h .$$

With respect to this action, the action groupoid object $G//G$ is canonically equipped with the right G -action by multiplication from the right. Whenever in the following we write

$$G//G \rightarrow *//G$$

we are referring to this latter definition.

Definition 3.6.173. Given a group object in $[C^{\text{op}}, \text{sSet}]$, write

$$(WG \rightarrow \bar{W}G) := (G/hG \rightarrow */_hG) \in [C^{\text{op}}, \text{sSet}]$$

for the morphism induced on homotopy quotients, def. 3.6.170, by the morphism of canonical action groupoid objects of example 3.6.172.

We will call this the *universal weakly G -principal bundle*.

This term will be justified by prop. 3.6.178, remark 3.6.179 and theorem 3.6.198 below. We now discuss some basic properties of this morphism.

Definition 3.6.174. For $\rho : P \times G \rightarrow P$ a G -action in $[C^{\text{op}}, \text{sSet}]$, we write

$$P \times_G WG := (P \times WG)/G \in [C^{\text{op}}, \text{sSet}]$$

for the quotient by the diagonal G -action with respect to the given right G action on P and the canonical right G -action on WG from prop. 3.6.178. We call this quotient the *Borel construction* of the G -action on P .

Proposition 3.6.175. For $P \times G \rightarrow P$ an action in $[C^{\text{op}}, \text{sSet}]$, there is an isomorphism

$$P/_hG \simeq P \times_G WG ,$$

between the homotopy quotient, def. 3.6.170, and the Borel construction. In particular, for all $n \in \mathbb{N}$ there are isomorphisms

$$(P/_hG)_n \simeq P_n \times G_{n-1} \times \cdots \times G_0 .$$

Proof. This follows by a straightforward computation.

Lemma 3.6.176. Let P be a Kan complex, G a simplicial group and $\rho : P \times G \rightarrow P$ an action. The following holds.

1. The quotient map $P \rightarrow P/G$ is a Kan fibration.
2. If the action is free, then P/G is a Kan complex.

The second statement is for instance lemma V3.7 in [GoJa99].

Lemma 3.6.177. For P a Kan complex and $P \times G \rightarrow P$ an action by a group object, the homotopy quotient $P/_hG$, def. 3.6.170, is itself a Kan complex.

Proof. By prop. 3.6.175 the homotopy quotient is isomorphic to the Borel construction. Since G acts freely on WG it acts freely on $P \times WG$. The statement then follows with lemma 3.6.176. \square

Proposition 3.6.178. *For G a group object in $[C^{\text{op}}, \text{sSet}]$, the morphism $WG \rightarrow \overline{WG}$ from def. 3.6.173 has the following properties.*

1. *It is isomorphic to the traditional morphism denoted by these symbols, e.g. [May67].*
2. *It is isomorphic to the décalage morphism $\text{Dec}_0 \overline{WG} \rightarrow \overline{WG}$, def. 2.3.31.*
3. *It is canonically equipped with a right G -action over \overline{WG} that makes it a weakly G -principal bundle (in fact the shear map is an isomorphism).*
4. *It is an objectwise Kan fibration replacement of the point inclusion $* \rightarrow \overline{WG}$.*

This is lemma 10 in [RoSt12].

Remark 3.6.179. Let $\hat{X} \rightarrow \overline{WG}$ be a morphism in $[C^{\text{op}}, \text{sSet}]$, presenting, by prop. 3.6.131, a morphism $X \rightarrow \mathbf{B}G$ in the ∞ -topos $\mathbf{H} = \text{Sh}_{\infty}(C)$. By prop. 3.6.163 every G -principal ∞ -bundle over X arises as the homotopy fiber of such a morphism. By using prop. 3.6.178 in prop. 2.3.8 it follows that the principal ∞ -bundle classified by $\hat{X} \rightarrow \overline{WG}$ is presented by the ordinary pullback of $WG \rightarrow \overline{WG}$. This is the defining property of the universal principal bundle.

In 3.6.10.4 below we show how this observation leads to a complete presentation of the theory of principal ∞ -bundles by simplicial weakly principal bundles.

3.6.10.4 Presentation in locally fibrant simplicial sheaves We discuss a presentation of the general notion of principal ∞ -bundles, 3.6.10.2 by weakly principal bundles in a 1-category of simplicial sheaves.

Let \mathbf{H} be a hypercomplete ∞ -topos (for instance a cohesive ∞ -topos), such that it admits a 1-site C with enough points.

Observation 3.6.180. By prop. 2.2.12 a category with weak equivalences that presents \mathbf{H} under simplicial localization, def. 2.1.25, is the category of simplicial 1-sheaves on C , $\text{sSh}(C)$, with the weak equivalences $W \subset \text{Mor}(\text{sSh}(C))$ being the stalkwise weak equivalences:

$$\mathbf{H} \simeq L_W \text{sSh}(C).$$

Also the full subcategory

$$\text{sSh}(C)_{\text{lfb}} \hookrightarrow \text{sSh}(C)$$

on the locally fibrant objects is a presentation.

Corollary 3.6.181. *Regard $\text{sSh}(C)_{\text{lfb}}$ as a category of fibrant objects, def. 3.6.143, with weak equivalences and fibrations the stalkwise weak equivalences and fibrations in $\text{sSet}_{\text{Quillen}}$, respectively, as in example 3.6.144.*

Then for any two objects $X, A \in \mathbf{H}$ there are simplicial sheaves, to be denoted by the same symbols, such that the hom ∞ -groupoid in \mathbf{H} from X to A is presented in $\text{sSet}_{\text{Quillen}}$ by the Kan complex of cocycles 3.6.9.2.

Proof. By theorem 3.6.146. \square

We now discuss for the general theory of principal ∞ -bundles in \mathbf{H} from 3.6.10.2 a corresponding realization in the presentation for \mathbf{H} given by $(\text{sSh}(C), W)$.

By prop. 3.6.131 every ∞ -group in \mathbf{H} is presented by an ordinary group in $\text{sSh}(C)$. It is too much to ask that also every G -principal ∞ -bundle is presented by a principal bundle in $\text{sSh}(C)$. But something close is true: every principal ∞ -bundle is presented by a *weakly principal* bundle in $\text{sSh}(C)$.

Definition 3.6.182. Let $X \in \text{sSh}(C)$ be any object, and let $G \in \text{sSh}(C)$ be equipped with the structure of a group object. A *weakly G -principal bundle* is

- an object $P \in \text{sSh}(C)$ (the *total space*);
- a local fibration $\pi: P \rightarrow X$ (the *bundle projection*);
- a right action

$$\begin{array}{ccc} P \times G & \xrightarrow{\rho} & P \\ & \searrow & \swarrow \\ & & X \end{array}$$

of G on P over X

such that

- the action of G is *weakly principal* in that the *shear map*

$$(p_1, \rho) : P \times G \rightarrow P \times_X P \quad (p, g) \mapsto (p, pg)$$

is a local weak equivalence.

Remark 3.6.183. We do not ask the G -action to be degreewise free as in [JaLu04], where a similar notion is considered. However we show in Corollary 3.6.200 below that each weakly G -principal bundle is equivalent to one with free G -action.

Definition 3.6.184. A morphism of weakly G -principal bundles $(\pi, \rho) \rightarrow (\pi', \rho')$ over X is a morphism $f: P \rightarrow P'$ in $\text{sSh}(C)$ that is G -equivariant and commutes with the bundle projections, hence such that it makes this diagram commute:

$$\begin{array}{ccc} P \times G & \xrightarrow{(f, \text{id})} & P' \times G \\ \downarrow \rho & & \downarrow \rho' \\ P & \xrightarrow{f} & P' \\ \searrow \pi & & \swarrow \pi' \\ & & X \end{array} .$$

Write

$$\text{wGBund}(X) \in \text{sSet}_{\text{Quillen}}$$

for the nerve of the category of weakly G -principal bundles and morphisms as above. The ∞ -groupoid that this presents under $\infty\text{Grpd} \simeq (\text{sSet}_{\text{Quillen}})^\circ$ we call the ∞ -*groupoid of weakly G -principal bundles over X* .

Lemma 3.6.185. Let $\pi: P \rightarrow X$ be a weakly G -principal bundle. Then the following statements are true:

1. For any point $p: * \rightarrow P$ the action of G induces a weak equivalence

$$G \longrightarrow P_x$$

where $x = \pi p$ and where P_x is the fiber of $P \rightarrow X$ over x .

2. For all $n \in \mathbb{N}$, the multi-shear maps

$$P \times G^n \rightarrow P^{\times_X^{n+1}} \quad (p, g_1, \dots, g_n) \mapsto (p, pg_1, \dots, pg_n)$$

are weak equivalences.

Proof. We consider the first statement. Regard the weak equivalence $P \times G \xrightarrow{\sim} P \times_X P$ as a morphism over P where in both cases the map to P is given by projection onto the first factor. By basic properties of categories of fibrant objects, both of these morphisms are fibrations. Therefore, by prop. 2.3.12 the pullback of the shear map along p is still a weak equivalence. But this pullback is just the map $G \rightarrow P_x$, which proves the claim.

For the second statement, we use induction on n . Suppose that $P \times G^n \rightarrow P^{\times_X^{n+1}}$ is a weak equivalence. By prop. 2.3.12, the pullback $P^{\times_X^n} \times_X (P \times G) \rightarrow P^{\times_X^{n+2}}$ of the shear map itself along $P^{\times_X^n} \rightarrow X$ is again a weak equivalence, as is the product $P \times G^n \times G \rightarrow P^{\times_X^{n+1}} \times G$ of the n -fold shear map with G . The composite of these two weak equivalences is the multi-shear map $P \times G^{n+1} \rightarrow P^{\times_X^{n+2}}$, which is hence a also weak equivalence.

Proposition 3.6.186. *Let $P \rightarrow X$ be a weakly G -principal bundle and let $f : Y \rightarrow X$ be an arbitrary morphism. Then the pullback $f^*P \rightarrow Y$ exists and is also canonically a weakly G -principal bundle. This operation extends to define a pullback morphism*

$$f^* : \text{wGBund}(X) \rightarrow \text{wGBund}(Y).$$

Proof. By basic properties of a category of fibrant objects:

The pullback f^*P exists and the morphism $f^*P \rightarrow Y$ is again a local fibration. Thus it only remains to show that f^*P is weakly principal, i.e. that the morphism $f^*P \times G \rightarrow f^*P \times_Y f^*P$ is a weak equivalence. This follows from prop. 2.3.12.

Remark 3.6.187. The functor f^* associated to the map $f : Y \rightarrow X$ above is the restriction of a functor $f^* : \text{sSh}(C)/X \rightarrow \text{sSh}(C)/Y$ mapping from simplicial sheaves over X to simplicial sheaves over Y . This functor f^* has a left adjoint $f_! : \text{sSh}(C)/Y \rightarrow \text{Sh}^{\Delta^{\text{op}}}/X$ given by composition along f , in other words

$$f_!(E \rightarrow Y) = E \rightarrow Y \xrightarrow{f} X.$$

Note that the functor $f_!$ does not usually restrict to a functor $f_! : \text{wGBund}(Y) \rightarrow \text{wGBund}(X)$. But when it does, we say that principal ∞ -bundles *satisfy descent along f* . In this situation, if P is a weakly G -principal bundle on Y , then P is weakly equivalent to the pulled-back principal ∞ -bundle $f^*f_!P$ on Y , in other words P ‘descends’ to $f_!P$.

The next result says that weakly G -principal bundles satisfy descent along local acyclic fibrations (hypercovers).

Proposition 3.6.188. *Let $p : Y \rightarrow X$ be a local acyclic fibration in $\text{sSh}(C)$. Then the functor $p_!$ defined above restricts to a functor $p_! : \text{wGBund}(Y) \rightarrow \text{wGBund}(X)$, left adjoint to $p^* : \text{wGBund}(X) \rightarrow \text{wGBund}(Y)$, hence to a homotopy equivalence in $\text{sSet}_{\text{Quillen}}$.*

Proof. Given a weakly G -principal bundle $P \rightarrow Y$, the first thing we have to check is that the map $P \times G \rightarrow P \times_X P$ is a weak equivalence. This map can be factored as $P \times G \rightarrow P \times_Y P \rightarrow P \times_X P$. Hence it suffices to show that the map $P \times_Y P \rightarrow P \times_X P$ is a weak equivalence. But this follows by prop. 2.3.12, since both pullbacks are along local fibrations and $Y \rightarrow X$ is a local weak equivalence by assumption.

This establishes the existence of the functor $p_!$. It is easy to see that it is left adjoint to p^* . This implies that it induces a homotopy equivalence in $\text{sSet}_{\text{Quillen}}$.

Corollary 3.6.189. *For $f : Y \rightarrow X$ a local weak equivalence, the induced functor $f^* : \text{wGBund}(X) \rightarrow \text{wGBund}(Y)$ is a homotopy equivalence.*

Proof. By lemma 2.3.9 we can factor the weak equivalence f into a composite of a local acyclic fibration and a left inverse to a local acyclic fibration. Therefore, by prop. 3.6.188, f^* may be factored as the composite of two homotopy equivalences, hence is itself a homotopy equivalence.

We discuss now how weakly G -principal bundles arise from the universal G -principal bundle, def. 3.6.173 by pullback, and how this establishes their equivalence with G -cocycles.

Proposition 3.6.190. For G a group object in $\text{sSh}(C)$, the map $WG \rightarrow \overline{W}G$ from def. 3.6.173 equipped with the G -action of prop. 3.6.178 is a weakly G -principal bundle.

Indeed, it is a strictly G -principal bundle. This is a classical fact, for instance around lemma V4.1 in [GoJa99]. In terms of the total simplicial set functor it is observed in section 4 of [RoSt12].

Proof. By inspection one finds that

$$\begin{array}{ccc} (G//G) \times G & \longrightarrow & G//G \\ \downarrow & & \downarrow \\ G//G & \longrightarrow & *//G \end{array}$$

is a pullback diagram in $[\Delta^{\text{op}}, \text{sSh}(C)]$. Since the total simplicial object functor T of def. 2.3.23 is right adjoint it preserves this pullback. This shows the principality of the shear map.

Definition 3.6.191. For $Y \rightarrow X$ a morphism in $\text{sSh}(C)$, write

$$\check{C}(Y) \in [\Delta^{\text{op}}, \text{sSh}(C)]$$

for its Čech nerve, given in degree n by the n -fold fiber product of Y over X

$$\check{C}(Y)_n := Y \times_X^{n+1}.$$

Observation 3.6.192. The canonical morphism of simplicial objects $\check{C}(Y) \rightarrow X$, with X regarded as a constant simplicial object induces under totalization, def. 2.3.23, and by prop. 2.3.26 a canonical morphism

$$T\check{C}(Y) \rightarrow X \in \text{sSh}(C).$$

Lemma 3.6.193. For $p : Y \rightarrow X$ a local acyclic fibration, the morphism $T\check{C}(Y) \rightarrow X$ from observation 3.6.192 is a local weak equivalence.

Proof. By pullback stability of local acyclic fibrations, for each $n \in \mathbb{N}$ the morphism $Y \times_X^n \rightarrow X$ is a local weak equivalence. By remark. 2.3.25 and prop. 2.3.26 this degreewise local weak equivalence is preserved by the functor T .

The main statement now is the following.

Theorem 3.6.194. For $P \rightarrow X$ a weakly G -principal bundle in $\text{sSh}(C)$, the canonical morphism

$$P/_hG \longrightarrow X$$

is a local acyclic fibration.

Proof. To see that the morphism is a local weak equivalence, factor $P//G \rightarrow X$ in $[\Delta^{\text{op}}, \text{sSh}(C)]$ via the multi-shear maps from lemma 3.6.185 through the Čech nerve, def. 3.6.191, as

$$P//G \rightarrow \check{C}(P) \rightarrow X.$$

Applying to this the total simplicial object functor T , def. 2.3.23, yields a factorization

$$P/_hG \rightarrow T\check{C}(P) \rightarrow X.$$

The left morphism is a weak equivalence because, by lemma 3.6.185, the multi-shear maps are weak equivalences and by corollary 2.3.27 T preserves sends degreewise weak equivalences to weak equivalences. The right map is a weak equivalence by lemma 3.6.193.

We now prove that $P/hG \rightarrow X$ is a local fibration. We need to show that for each topos point p of $\text{Sh}(C)$ the morphism of stalks $p(P/hG) \rightarrow p(X)$ is a Kan fibration of simplicial sets. By prop. 3.6.175 this means equivalently that the morphism

$$p(P \times_G WG) \rightarrow p(X)$$

is a Kan fibration. By definition of topos point, p commutes with all the finite products and colimits involved here. Therefore equivalently we need to show that

$$p(P) \times_{p(G)} Wp(G) \rightarrow p(X)$$

is a Kan fibration for all topos points p .

Observe that this morphism factors the projection $p(P) \times W(p(G)) \rightarrow p(X)$ as

$$p(P) \times W(p(G)) \rightarrow p(P) \times_{p(G)} W(p(G)) \rightarrow p(X)$$

in sSet . Here the first morphism is a Kan fibration by lemma 3.6.176, which in particular is also surjective on vertices. Also the total composite morphism is a Kan fibration, since $W(p(G))$ is Kan fibrant. From this the desired result follows with the next lemma 3.6.195.

Lemma 3.6.195. *Suppose that $X \xrightarrow{p} Y \xrightarrow{q} Z$ is a diagram of simplicial sets such that p is a Kan fibration surjective on vertices and qp is a Kan fibration. Then q is also a Kan fibration.*

Proof. Consider a lifting problem of the form

$$\begin{array}{ccc} \Lambda^k[n] & \longrightarrow & Y \\ \downarrow & & \downarrow q \\ \Delta[n] & \longrightarrow & Z. \end{array}$$

Choose a 0-simplex of X which projects to the 0-simplex of Y corresponding to the image of the vertex 0 under the map $\Lambda^k[n] \rightarrow Y$. Since $\Delta[0] \rightarrow \Lambda^k[n]$ is an acyclic cofibration, we may choose a map $\Lambda^k[n] \rightarrow X$ such that the diagram

$$\begin{array}{ccc} \Delta[0] & \longrightarrow & X \\ \downarrow & \nearrow & \downarrow p \\ \Lambda^k[n] & \longrightarrow & Y \end{array}$$

commutes. This map gives rise to a commutative diagram

$$\begin{array}{ccc} \Lambda^k[n] & \longrightarrow & X \\ \downarrow & & \downarrow qp \\ \Delta[n] & \longrightarrow & Z \end{array}$$

and any diagonal filler in this diagram gives a solution of the original lifting problem.

We now discuss the equivalence between weakly G -principal bundles and G -cocycles. For $X, A \in \text{sSh}(C)$, write $\text{Cocycle}(X, A)$ for the category of cocycles from X to A , according to 3.6.9.2.

Definition 3.6.196. Let $X, G \in \text{sSh}(C)$ with G equipped with the structure of a group object (hence necessarily locally fibrant) and also with X being locally fibrant.

Define a functor

$$\text{Extr} : \text{wGBund}(X) \rightarrow \text{Cocycle}(X, \overline{WG})$$

(“extracting” a cocycle) on objects by sending a weakly G -principal bundle $P \rightarrow X$ to the cocycle

$$X \xleftarrow{\sim} P/hG \longrightarrow \overline{WG} ,$$

where the left morphism is the local acyclic fibration from theorem 3.6.194, and where the right morphism is the image under the total simplicial object functor, def. 2.3.23, of the canonical morphism $P//G \rightarrow *//G$ of simplicial objects.

Define also a functor

$$\text{Rec} : \text{Cocycle}(X, \overline{WG}) \rightarrow \text{wGBund}(X)$$

(“reconstruction” of the bundle) which on objects takes a cocycle $X \xleftarrow{\pi} Y \xrightarrow{g} \overline{WG}$ to the weakly G -principal bundle

$$g^*WG \rightarrow Y \xrightarrow{\pi} X ,$$

which is the pullback of the universal G -principal bundle, def. 3.6.173, along g , and which on morphisms takes a coboundary to the morphism between pullbacks induced from the corresponding morphism of pullback diagrams.

Observation 3.6.197. The functor Extr sends the universal G -principal bundle $WG \rightarrow \overline{WG}$ to the cocycle

$$\overline{WG} \simeq * \times_G WG \xrightarrow{\sim} WG \times_G WG \xrightarrow{\sim} WG \times_G * \simeq \overline{WG} .$$

Write

$$q : \text{Cocycle}(X, \overline{WG}) \rightarrow \text{Cocycle}(X, \overline{WG})$$

for the functor given by postcomposition with this universal cocycle. This has an evident left and right adjoint \bar{q} . Therefore under the simplicial nerve these functors induce homotopy equivalences in $\text{sSet}_{\text{Quillen}}$.

Theorem 3.6.198. *The functors Extr and Rec from def. 3.6.196 induce weak equivalences*

$$N\text{wGBund}(X) \simeq N\text{Cocycle}(X, \overline{WG}) \in \text{sSet}_{\text{Quillen}}$$

between the simplicial nerves of the category of weakly G -principal bundles and of cocycles, respectively.

Proof. We construct natural transformations

$$\text{Extr} \circ \text{Rec} \Rightarrow q$$

and

$$\text{Rec} \circ \text{Extr} \Rightarrow \text{id} ,$$

where q is the homotopy equivalence from observation 3.6.197.

For

$$X \xleftarrow{\pi} Y \xrightarrow{f} \overline{WG} .$$

a cocycle, its image under $\text{Extr} \circ \text{Rec}$ is

$$X \leftarrow (f^*WG)/hG \rightarrow \overline{WG} .$$

The morphism $(f^*WG)/hG$ factors through Y by construction, so that the left triangle in the diagram

$$\begin{array}{ccc} & (f^*WG)/hG & \\ \swarrow \sim & \downarrow & \searrow \\ X & & \overline{WG} \\ \swarrow \sim & \uparrow & \nearrow q(f) \\ & Y & \end{array}$$

commutes. The top right morphism is by definition the image under the total simplicial set functor, def. 2.3.23, of $(f^*WG)//G \rightarrow *//G$. This factors the top horizontal morphism in

$$\begin{array}{ccccc} (f^*WG)//G & \longrightarrow & (WG)//G & \longrightarrow & *//G \\ \downarrow & & \downarrow & & \\ Y & \xrightarrow{f} & \overline{WG} & & \end{array}$$

Applying the total simplicial object functor to this diagram gives the above commuting triangle on the right. Clearly this construction is natural and hence provides a natural transformation $\text{Extr Rec} \Rightarrow q$.

For the other natural transformation, let now $P \rightarrow X$ be a weakly G -principal bundle. This induces the following commutative diagram of simplicial objects (with P and X regarded as constant simplicial objects)

$$\begin{array}{ccccccc} P & \longleftarrow & P \times_X (P//G) & \xleftarrow[\sim]{\phi} & (P \times G)//G & \longrightarrow & G//G \\ \downarrow & & \downarrow & & \downarrow & & \downarrow \\ X & \longleftarrow & P//G & \xlongequal{\quad} & P//G & \longrightarrow & *//G \end{array},$$

where the left and the right square are pullbacks, and where the top horizontal morphism ϕ is the degreewise local weak equivalence which is degreewise induced by the shear map, composed with exchange of the two factors.

Explicitly, in degree 0 the morphism ϕ is given on generalized elements by

$$(p', g) \xleftarrow{\phi_0} (p'g, p')$$

and in degree 1 by

$$\begin{array}{ccc} (p'g, (p', h)) & \xleftarrow{\phi_1} & ((p', g), h) \\ \downarrow d_0 & & \downarrow d_0 \\ (p'g, p'h) & \xleftarrow{\phi_0} & ((p'h, h^{-1}g)) \end{array},$$

etc. Here the top horizontal morphisms also respect the right G -actions ρ induced from the weakly G -principal bundle structure on $P \rightarrow X$ and on $G//G \rightarrow *//G$. For instance the respect of the right G -action of ϕ in degree 0 is on elements verified by

$$\begin{array}{ccc} ((p'g, p'), k) & \xleftarrow{\phi_0} & ((p', g), k) \\ \downarrow \rho & & \downarrow \rho \\ (p'gk, p') & \xleftarrow{\phi_0} & ((p', gk)) \end{array}$$

The image of the above diagram under the total simplicial object functor, which preserves all the pullbacks and weak equivalences involved, is

$$\begin{array}{ccccccc} P & \xleftarrow{\sim} & P \times_X P/hG & \xleftarrow{\sim} & (P \times G)/hG & \longrightarrow & WG \\ \downarrow & & \downarrow & & \downarrow & & \downarrow \\ X & \xleftarrow{\sim} & P/hG & \xlongequal{\quad} & P/hG & \longrightarrow & \overline{WG} \end{array}$$

Here the total bottom span is the cocycle $\text{Extr}(P)$, and so the object $(P \times G)/hG$ over X is $\text{Rec}(\text{Extr}(P))$. Therefore this exhibits a natural morphism $\text{Rec Extr}P \rightarrow P$.

Remark 3.6.199. By theorem 3.6.146 the simplicial set $\mathrm{NCocycle}(X, \overline{WG})$ is a presentation of the intrinsic cocycle ∞ -groupoid $\mathbf{H}(X, \mathbf{B}G)$ of the hypercomplete ∞ -topos $\mathbf{H} = \mathrm{Sh}_{\infty}^{\mathrm{hc}}(C)$. Therefore the equivalence of theorem 3.6.198 is a presentation of that of theorem 3.6.167,

$$GBund_{\infty}(X) \simeq \mathbf{H}(X, \mathbf{B}G)$$

between the ∞ -groupoid of G -principal ∞ -bundles in \mathbf{H} and the intrinsic cocycle ∞ -groupoid of \mathbf{H} .

Corollary 3.6.200. *For each weakly G -principal bundle $P \rightarrow X$ there is a weakly G -principal bundle P^f with a levelwise free G -action and a weak equivalence $P^f \xrightarrow{\sim} P$ of weakly G -principal bundles over X . In fact, the assignment $P \mapsto P^f$ is an homotopy inverse to the full inclusion of weakly G -principal bundles with free action into all weakly G -principal bundles.*

Proof. Note that the universal bundle $WG \rightarrow \overline{WG}$ carries a free G -action, in the sense that the levelwise action of G_n on $(WG)_n$ is free. This means that the functor Rec from the proof of theorem 3.6.198 indeed takes values in weakly G -principal bundles with free action. Hence we can set

$$P^f := \mathrm{Rec}(\mathrm{Extr}(P)) = (P \times G) /_h G.$$

By the discussion there we have a natural morphism $P^f \rightarrow P$ and one checks that this exhibits the homotopy inverse.

3.6.11 Associated fiber bundles

We discuss the notion of representations/actions/modules of ∞ -groups in an ∞ -topos and the structures directly induced by this: the corresponding twisted cohomology is cohomology with coefficients in *modules* (the generalization of group cohomology with coefficients in a module) and the corresponding notion of *associated ∞ -bundles*.

3.6.11.1 General abstract This section draws from [NSS12a].

Let \mathbf{H} be an ∞ -topos, $G \in \mathrm{Grp}(\mathbf{H})$ an ∞ -group. Fix an action $\rho : V \times G \rightarrow V$ (Definition 3.6.149) on an object $V \in \mathbf{H}$. We discuss the induced notion of ρ -associated V -fiber ∞ -bundles. We show that there is a *universal* ρ -associated V -fiber bundle over $\mathbf{B}G$ and observe that under Theorem 3.6.167 this is effectively identified with the action itself. Accordingly, we also further discuss ∞ -actions as such.

Definition 3.6.201. For $V, X \in \mathbf{H}$ any two objects, a V -fiber ∞ -bundle over X is a morphism $E \rightarrow X$, such that there is an effective epimorphism $U \twoheadrightarrow X$ and an ∞ -pullback of the form

$$\begin{array}{ccc} U \times V & \longrightarrow & E \\ \downarrow & & \downarrow \\ U & \twoheadrightarrow & X. \end{array}$$

We say that $E \rightarrow X$ locally trivializes with respect to U . As usual, we often say V -bundle for short.

Definition 3.6.202. For $P \rightarrow X$ a G -principal ∞ -bundle, we write

$$P \times_G V := (P \times V) // G$$

for the ∞ -quotient of the diagonal ∞ -action of G on $P \times V$. Equipped with the canonical morphism $P \times_G V \rightarrow X$ we call this the ∞ -bundle ρ -associated to P .

Remark 3.6.203. The diagonal G -action on $P \times V$ is the product in $G\text{Action}(\mathbf{H})$ of the given actions on P and on V . Since $G\text{Action}(\mathbf{H})$ is a full sub- ∞ -category of a slice category of a functor category, the product is given by a degreewise pullback in \mathbf{H} :

$$\begin{array}{ccc} P \times V \times G^{\times n} & \longrightarrow & V \times G^{\times n} \\ \downarrow & & \downarrow \\ P \times G^{\times n} & \longrightarrow & G^{\times n}. \end{array}$$

and so

$$P \times_G V \simeq \varinjlim_n (P \times V \times G^{\times n}).$$

The canonical bundle morphism of the corresponding ρ -associated ∞ -bundle is the realization of the left morphism of this diagram:

$$\begin{array}{ccc} P \times_G V & := & \varinjlim_n (P \times V \times G^{\times n}) \\ \downarrow & & \downarrow \\ X & \simeq & \varinjlim_n (P \times G^{\times n}). \end{array}$$

Example 3.6.204. By Theorem 3.6.167 every ∞ -group action $\rho : V \times G \rightarrow V$ has a classifying morphism \mathbf{c} defined on its homotopy quotient, which fits into a fiber sequence of the form

$$\begin{array}{ccc} V & \longrightarrow & V//G \\ & & \downarrow \mathbf{c} \\ & & \mathbf{B}G. \end{array}$$

Regarded as an ∞ -bundle, this is ρ -associated to the universal G -principal ∞ -bundle $* \longrightarrow \mathbf{B}G$ from Example 3.6.164:

$$V//G \simeq * \times_G V.$$

Lemma 3.6.205. *The realization functor $\varinjlim : \text{Grpd}(\mathbf{H}) \rightarrow \mathbf{H}$ preserves the ∞ -pullback of Remark 3.6.203:*

$$P \times_G V \simeq \varinjlim_n (P \times V \times G^{\times n}) \simeq (\varinjlim_n P \times G^{\times n}) \times_{(\varinjlim_n G^{\times n})} (\varinjlim_n V \times G^{\times n}).$$

Proof. Generally, let $X \rightarrow Y \leftarrow Z \in \text{Grpd}(\mathbf{H})$ be a diagram of groupoid objects, such that in the induced diagram

$$\begin{array}{ccccc} X_0 & \longrightarrow & Y_0 & \longleftarrow & Z_0 \\ \downarrow & & \downarrow & & \downarrow \\ \varinjlim_n X_n & \longrightarrow & \varinjlim_n Y_n & \longleftarrow & \varinjlim_n Z_n \end{array}$$

the left square is an ∞ -pullback. By the third ∞ -Giraud axiom (Definition 2.2.2) the vertical morphisms are effective epi, as indicated. By assumption we have a pasting of ∞ -pullbacks as shown on the left of the

following diagram, and by the pasting law (Proposition 2.3.2) this is equivalent to the pasting shown on the right:

$$\begin{array}{ccc}
X_0 \times_{Y_0} Z_0 & \longrightarrow & Z_0 \\
\downarrow & & \downarrow \\
X_0 & \longrightarrow & Y_0 \\
\downarrow & & \downarrow \\
\varinjlim_n X_n & \longrightarrow & \varinjlim_n Y_n
\end{array}
\quad \simeq \quad
\begin{array}{ccc}
X_0 \times_{Y_0} Z_0 & \longrightarrow & Z_0 \\
\downarrow & & \downarrow \\
(\varinjlim_n X_n) \times (\varinjlim_n Y_n) & \longrightarrow & \varinjlim_n Z_n \\
\downarrow & & \downarrow \\
\varinjlim_n X_n & \longrightarrow & \varinjlim_n Y_n
\end{array}$$

Since effective epimorphisms are stable under ∞ -pullback, this identifies the canonical morphism

$$X_0 \times_{Y_0} Z_0 \rightarrow (\varinjlim_n X_n) \times (\varinjlim_n Y_n) \rightarrow (\varinjlim_n Z_n)$$

as an effective epimorphism, as indicated.

Since ∞ -limits commute over each other, the Čech nerve of this morphism is the groupoid object $[n] \mapsto X_n \times_{Y_n} Z_n$. Therefore the third ∞ -Giraud axiom now says that \varinjlim preserves the ∞ -pullback of groupoid objects:

$$\varinjlim(X \times_Y Z) \simeq \varinjlim_n(X_n \times_{Y_n} Z_n) \simeq (\varinjlim_n X_n) \times (\varinjlim_n Y_n) \rightarrow (\varinjlim_n Z_n).$$

Consider this now in the special case that $X \rightarrow Y \leftarrow Z$ is $(P \times G^{\times \bullet}) \rightarrow G^{\times \bullet} \leftarrow (V \times G^{\times \bullet})$. Theorem 3.6.167 implies that the initial assumption above is met, in that $P \simeq (P//G) \times_{*/G} * \simeq X \times_{\mathbf{B}G} *$, and so the claim follows. \square

Proposition 3.6.206. *For $g_X : X \rightarrow \mathbf{B}G$ a morphism and $P \rightarrow X$ the corresponding G -principal ∞ -bundle according to Theorem 3.6.167, there is a natural equivalence*

$$g_X^*(V//G) \simeq P \times_G V$$

over X , between the pullback of the ρ -associated ∞ -bundle $V//G \xrightarrow{c} \mathbf{B}G$ of Example 3.6.204 and the ∞ -bundle ρ -associated to P by Definition 3.6.202.

Proof. By Remark 3.6.203 the product action is given by the pullback

$$\begin{array}{ccc}
P \times V \times G^{\times \bullet} & \longrightarrow & V \times G^{\times \bullet} \\
\downarrow & & \downarrow \\
P \times G^{\times \bullet} & \longrightarrow & G^{\times \bullet}
\end{array}$$

in $\mathbf{H}^{\Delta^{\text{op}}}$. By Lemma 3.6.205 the realization functor preserves this ∞ -pullback. By Remark 3.6.203 it sends the left morphism to the associated bundle, and by Theorem 3.6.167 it sends the bottom morphism to g_X . Therefore it produces an ∞ -pullback diagram of the form

$$\begin{array}{ccc}
V \times_G P & \longrightarrow & V//G \\
\downarrow & & \downarrow c \\
X & \xrightarrow{g_X} & \mathbf{B}G
\end{array}$$

\square

Remark 3.6.207. This says that $V//G \xrightarrow{c} \mathbf{BG}$ is both, the V -fiber ∞ -bundle ρ -associated to the universal G -principal ∞ -bundle, Observation 3.6.204, as well as the universal ∞ -bundle for ρ -associated ∞ -bundles.

Proposition 3.6.208. *Every ρ -associated ∞ -bundle is a V -fiber ∞ -bundle, Definition 3.6.201.*

Proof. Let $P \times_G V \rightarrow X$ be a ρ -associated ∞ -bundle. By the previous Proposition 3.6.206 it is the pullback $g_X^*(V//G)$ of the universal ρ -associated bundle. By Proposition 3.6.161 there exists an effective epimorphism $U \twoheadrightarrow X$ over which P trivializes, hence such that $g_X|_U$ factors through the point, up to equivalence. In summary and by the pasting law, Proposition 2.3.2, this gives a pasting of ∞ -pullbacks of the form

$$\begin{array}{ccccc} U \times V & \longrightarrow & P \times_G V & \longrightarrow & V//G \\ \downarrow & & \downarrow & & \downarrow \\ U & \twoheadrightarrow & X & \xrightarrow{g_X} & \mathbf{BG} \\ & \searrow & \downarrow & \nearrow & \\ & & * & & \end{array}$$

which exhibits $P \times_G V \rightarrow X$ as a V -fiber bundle by a local trivialization over U . □

So far this shows that every ρ -associated ∞ -bundle is a V -fiber bundle. We want to show that, conversely, every V -fiber bundle is associated to a principal ∞ -bundle.

Definition 3.6.209. Let $V \in \mathbf{H}$ be a κ -compact object, for some regular cardinal κ . By the characterization of Definition 2.2.3, there exists an ∞ -pullback square in \mathbf{H} of the form

$$\begin{array}{ccc} V & \longrightarrow & \widehat{\mathbf{Obj}}_\kappa \\ \downarrow & & \downarrow \\ * & \xrightarrow{\vdash V} & \mathbf{Obj}_\kappa \end{array}$$

Write

$$\mathbf{BAut}(V) := \mathrm{im}(\vdash V)$$

for the 1-image, Definition 3.6.37, of the classifying morphism $\vdash V$ of V . By definition this comes with an effective epimorphism

$$* \twoheadrightarrow \mathbf{BAut}(V) \hookrightarrow \mathbf{Obj}_\kappa,$$

and hence, by Proposition 3.6.118, it is the delooping of an ∞ -group

$$\mathbf{Aut}(V) \in \mathrm{Grp}(\mathbf{H})$$

as indicated. We call this the *internal automorphism ∞ -group* of V .

By the pasting law, Proposition 2.3.2, the image factorization gives a pasting of ∞ -pullback diagrams of the form

$$\begin{array}{ccccc} V & \longrightarrow & V//\mathbf{Aut}(V) & \longrightarrow & \widehat{\mathbf{Obj}}_\kappa \\ \downarrow & & \downarrow c_V & & \downarrow \\ * & \xrightarrow{\vdash V} & \mathbf{BAut}(V) & \hookrightarrow & \mathbf{Obj}_\kappa \end{array}$$

By Theorem 3.6.167 this defines a canonical ∞ -action

$$\rho_{\mathbf{Aut}(V)} : V \times \mathbf{Aut}(V) \rightarrow V$$

of $\mathbf{Aut}(V)$ on V with homotopy quotient $V//\mathbf{Aut}(V)$ as indicated.

Proposition 3.6.210. *Every V -fiber ∞ -bundle is $\rho_{\mathbf{Aut}(V)}$ -associated to an $\mathbf{Aut}(V)$ -principal ∞ -bundle.*

Proof. Let $E \rightarrow V$ be a V -fiber ∞ -bundle. By Definition 3.6.201 there exists an effective epimorphism $U \twoheadrightarrow X$ along which the bundle trivializes locally. It follows by the second Axiom in Definition 2.2.3 that on U the morphism $X \xrightarrow{\vdash E} \mathbf{Obj}_\kappa$ which classifies $E \rightarrow X$ factors through the point

$$\begin{array}{ccccc} U \times V & \longrightarrow & E & \longrightarrow & \widehat{\mathbf{Obj}}_\kappa \\ \downarrow & & \downarrow & & \downarrow \\ U & \twoheadrightarrow & X & \xrightarrow{\vdash E} & \mathbf{Obj}_\kappa \\ & \searrow & \downarrow & \nearrow & \\ & & * & \xrightarrow{\vdash V} & \end{array}$$

Since the point inclusion, in turn, factors through its 1-image $\mathbf{BAut}(V)$, Definition 3.6.209, this yields the outer commuting diagram of the following form

$$\begin{array}{ccccc} U & \longrightarrow & * & \longrightarrow & \mathbf{BAut}(V) \\ \downarrow & & \nearrow g & & \downarrow \\ X & \xrightarrow{\vdash E} & & & \mathbf{Obj}_\kappa \end{array}$$

By the epi/mono factorization system of Proposition 3.6.33 there is a diagonal lift g as indicated. Using again the pasting law and by Definition 3.6.209 this factorization induces a pasting of ∞ -pullbacks of the form

$$\begin{array}{ccccc} E & \longrightarrow & V//\mathbf{Aut}(V) & \longrightarrow & \widehat{\mathbf{Obj}}_\kappa \\ \downarrow & & \downarrow c_V & & \downarrow \\ X & \xrightarrow{g} & \mathbf{BAut}(V) & \hookrightarrow & \mathbf{Obj}_\kappa \end{array}$$

Finally, by Proposition 3.6.206, this exhibits $E \rightarrow X$ as being $\rho_{\mathbf{Aut}(V)}$ -associated to the $\mathbf{Aut}(V)$ -principal ∞ -bundle with class $[g] \in H^1(X, G)$. \square

Theorem 3.6.211. *V -fiber ∞ -bundles over $X \in \mathbf{H}$ are classified by $H^1(X, \mathbf{Aut}(V))$.*

Under this classification, the V -fiber ∞ -bundle corresponding to $[g] \in H^1(X, \mathbf{Aut}(V))$ is identified, up to equivalence, with the $\rho_{\mathbf{Aut}(V)}$ -associated ∞ -bundle (Definition 3.6.202) to the $\mathbf{Aut}(V)$ -principal ∞ -bundle corresponding to $[g]$ by Theorem 3.6.167.

Proof. By Proposition 3.6.210 every morphism $X \xrightarrow{\vdash E} \mathbf{Obj}_\kappa$ that classifies a small ∞ -bundle $E \rightarrow X$ which happens to be a V -fiber ∞ -bundle factors via some g through the moduli for $\mathbf{Aut}(V)$ -principal ∞ -bundles

$$\begin{array}{ccccc} X & \xrightarrow{g} & \mathbf{BAut}(V) & \hookrightarrow & \mathbf{Obj}_\kappa \\ & \searrow & \downarrow & \nearrow & \\ & & * & \xrightarrow{\vdash E} & \end{array}$$

Therefore it only remains to show that also every homotopy $(\vdash E_1) \Rightarrow (\vdash E_2)$ factors through a homotopy $g_1 \Rightarrow g_2$. This follows by applying the epi/mono lifting property of Proposition 3.6.33 to the diagram

$$\begin{array}{ccccc} X \amalg X & \xrightarrow{(g_1, g_2)} & \mathbf{BAut}(V) & & \\ \downarrow & \nearrow & \downarrow & & \\ X & \longrightarrow & \mathbf{Obj}_\kappa & & \end{array}$$

The outer diagram exhibits the original homotopy. The left morphism is an effective epi (for instance immediately by Proposition 3.6.39), the right morphism is a monomorphism by construction. Therefore the dashed lift exists as indicated and so the top left triangular diagram exhibits the desired factorizing homotopy. \square

Remark 3.6.212. In the special case that $\mathbf{H} = \text{Grpd}_\infty$, the classification Theorem 3.6.211 is classical [St63a, May67], traditionally stated in (what in modern terminology is) the presentation of Grpd_∞ by simplicial sets or by topological spaces. Recent discussions include [BlCh12]. For \mathbf{H} a general 1-localic ∞ -topos (meaning: with a 1-site of definition), the statement of Theorem 3.6.211 appears in [We11], formulated there in terms of the presentation of \mathbf{H} by simplicial presheaves. (We discuss the relation of these presentations to the above general abstract result in [NSS12b].) Finally, one finds that the classification of G -gerbes [Gir71] and G -2-gerbes in [Br94] is the special case of the general statement, for $V = \mathbf{B}G$ and G a 1-truncated ∞ -group. This we discuss below in Section 3.6.15.

We close this section with a list of some fundamental classes of examples of ∞ -actions, or equivalently, by Remark 3.6.207, of universal associated ∞ -bundles. For doing so we use again that, by Theorem 3.6.167, to give an ∞ -action of G on V is equivalent to giving a fiber sequence of the form $V \rightarrow V//G \rightarrow \mathbf{B}G$.

Example 3.6.213. The following is a list of examples for ∞ -actions of ∞ -groups $G \in \text{Grp}(\mathbf{H})$ on objects in \mathbf{H} .

We display the universal associated ∞ -bundles, remark 3.6.207, over the moduli $\mathbf{B}G$ of G -principal ∞ -bundles, that characterize these ∞ -actions according to theorem 3.6.167, as discussed in 3.6.11.

So an ∞ -action of some ∞ -group G on an object V is displayed as

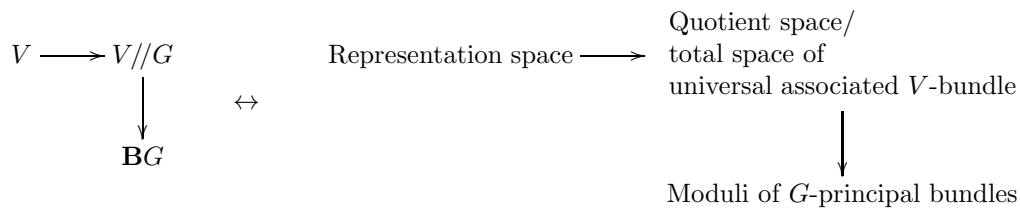

The examples are listed roughly ordered by generality. The first are classes of examples that exist in every ∞ -topos. The more axioms on the ambient ∞ -topos are needed, the further down the list the example appears.

1. For every $V \in \mathbf{H}$, the fiber sequence

$$\begin{array}{ccc}
 V & \xrightarrow{(\text{id}_V, \text{pt}_{\mathbf{B}G})} & V \times \mathbf{B}G \\
 & & \downarrow p_2 \\
 & & \mathbf{B}G
 \end{array}$$

is the *trivial* ∞ -action of G on V .

2. For every $G \in \text{Grp}(\mathbf{H})$, the fiber sequence

$$\begin{array}{ccc}
 G & \longrightarrow & * \\
 & & \downarrow \\
 & & \mathbf{B}G
 \end{array}$$

which defines $\mathbf{B}G$ by Theorem 3.6.113 induces the *right action of G on itself*

$$* \simeq G//G.$$

At the same time this sequence, but now regarded as a bundle over $\mathbf{B}G$, is the universal G -principal ∞ -bundle, Remark 3.6.164.

3. For every object $X \in \mathbf{H}$ write

$$\mathbf{L}X := X \times_{X \times X} X$$

for its *free loop space* object, the ∞ -fiber product of the diagonal on X along itself

$$\begin{array}{ccc} \mathbf{L}X & \longrightarrow & X \\ \text{ev}_* \downarrow & & \downarrow \\ X & \longrightarrow & X \times X \end{array} .$$

For every $G \in \text{Grp}(\mathbf{H})$ there is a fiber sequence

$$\begin{array}{ccc} G & \longrightarrow & \mathbf{L}BG \\ & & \downarrow \text{ev}_* \\ & & \mathbf{B}G \end{array} .$$

This exhibits the *adjoint action of G on itself*

$$\mathbf{L}BG \simeq G //_{\text{ad}} G .$$

4. For every $V \in \mathbf{H}$ there is the canonical ∞ -action *by automorphisms* of the *automorphism ∞ -group* $\mathbf{Aut}(V)$, def. 3.6.209, on V , exhibited by the fiber sequence on the left of the pasting diagram of ∞ -pullbacks

$$\begin{array}{ccccc} V & \longrightarrow & V // \mathbf{Aut}(V) & \longrightarrow & \widehat{\text{Obj}} \\ \downarrow & & \downarrow & & \downarrow \\ * & \longrightarrow & \mathbf{BAut}(V) & \hookrightarrow & \text{Obj} \end{array} ,$$

$\underbrace{\hspace{10em}}_{\vdash V}$

5. For $\rho_1, \rho_2 \in \mathbf{H}_{/\mathbf{B}G}$ two G - ∞ -actions on objects $V_1, V_2 \in \mathbf{H}$, respectively, their internal hom $[\rho_1, \rho_2] \in \mathbf{H}_{/\mathbf{B}G}$ in the slice over $\mathbf{B}G$ is a G - ∞ -action on the internal hom $[V_1, V_2] \in \mathbf{H}$:

$$\begin{array}{ccc} [V_1, V_2] & \longrightarrow & [V_1, V_2] // G \simeq \sum_{\mathbf{B}G} [\rho_1, \rho_2] \\ & & \downarrow \\ & & \mathbf{B}G \end{array} ,$$

hence $[V_1, V_2] // G \simeq \sum_{\mathbf{B}G} [\rho_1, \rho_2]$ (this follows by the fact that the inverse image of base change along $\text{pt}_{\mathbf{B}G} : * \rightarrow \mathbf{B}G$ is a cartesian closed ∞ -functor and hence preserves internal homs¹⁰) This is the *conjugation ∞ -action* of G on morphisms $V_1 \rightarrow V_2$ by pre- and postcomposition with the action of G on V_1 and V_2 , respectively.

6. The *precomposition action* of the automorphism ∞ -group $\mathbf{Aut}(V)$ on a mapping space $[V, A]$ is given by

$$\begin{array}{ccc} [V, A] & \longrightarrow & \sum_{\mathbf{B}G} [\rho_{\text{aut}}, \mathbf{B}G^* A] \\ & & \downarrow \\ & & \mathbf{BAut}(V) \end{array} .$$

¹⁰U.S. thanks Mike Shulman for discussion of this point.

7. Let now \mathbf{H} be a differential cohesive ∞ -topos, 3. Let $\mathbb{G} \in \text{Grp}(\mathbf{H})$ be a braided ∞ -group, def. 3.6.116, and write $\Omega_{\text{cl}}^2(-, \mathbb{G}) \rightarrow \mathbf{B}\mathbb{G}_{\text{conn}}$ for the corresponding moduli of \mathbb{G} -differential cocycles, 3.9.6.2.

Let furthermore

$$\begin{array}{ccc} & & \mathbf{B}\mathbb{G}_{\text{conn}} \\ & \nearrow \nabla & \downarrow F_{(-)} \\ X & \xrightarrow{\omega} & \mathbf{B}\mathbb{G} \end{array}$$

a pre-symplectic structure ω with prequantization ∇ , 3.9.13 and let ρ be an action of \mathbb{G} on some V . Then the (higher Heisenberg group-) ∞ -action of higher prequantum operators on the space $\Gamma_X(E)$ of higher prequantum states is

$$\begin{array}{c} \Gamma_X(E) \longrightarrow \prod_{\mathbf{B}\mathbb{G}} \left(\left[\sum_U \nabla, \rho \right] // \prod_U \mathbf{Aut}(\nabla) \right) \\ \downarrow \\ \mathbf{Aut}_{\mathbf{H}}(\nabla) \end{array}$$

where E is the ρ -associated V -bundle to $\sum_U \nabla$.

8. Let specifically $\mathbf{H} = \text{Smooth}\infty\text{Grpd}$, 4.4.

There we have

- (a) the ∞ -action of the moduli of circle principal bundles (the circle 2-group) $\mathbf{B}U(1)$ on the moduli of unitary bundles, 5.2.3,

$$\begin{array}{ccc} \mathbf{B}U(n) & \longrightarrow & \mathbf{B}PU(n) \\ & & \downarrow \text{dd}_n \\ & & \mathbf{B}^2U(1) \end{array}$$

- (b) the ∞ -action of the moduli of circle principal 2-bundles (the circle 3-group) $\mathbf{B}^2U(1)$ on the moduli for String-principal 2-bundles, 5.1.4,

$$\begin{array}{ccc} \mathbf{B}\text{String} & \longrightarrow & \mathbf{B}\text{Spin} \\ & & \downarrow \frac{1}{2}\mathbf{P}_1 \\ & & \mathbf{B}^3U(1) \end{array}$$

- (c) the ∞ -action of the moduli of circle principal 6-bundles (the circle 7-group) $\mathbf{B}^6U(1)$ on the moduli for Fivebrane-principal 6-bundles, 5.1.5,

$$\begin{array}{ccc} \mathbf{B}\text{Fivebrane} & \longrightarrow & \mathbf{B}\text{String} \\ & & \downarrow \frac{1}{6}\mathbf{P}_2 \\ & & \mathbf{B}^7U(1) \end{array}$$

For more examples along these lines see 5.2.1.

3.6.11.2 Presentation in locally fibrant simplicial sheaves We discuss associated ∞ -bundles in an ∞ -topos $\mathbf{H} = \mathrm{Sh}_\infty(C)$ in terms of the presentation of \mathbf{H} by locally fibrant simplicial sheaves, corresponding to the respective presentation of principal ∞ -bundles from 3.6.10.4.

This section draws from [NSS12b].

Let C be a site with terminal object.

By prop. 3.6.131 every ∞ -group over C has a presentation by a sheaf of simplicial groups $G \in \mathrm{Grp}(\mathrm{sSh}(C)_{\mathrm{lfb}})$. Moreover, by theorem 3.6.198 every ∞ -action of G on an object V , def. 3.6.149, is exhibited by a weakly principal simplicial bundle

$$\begin{array}{ccc} V & \longrightarrow & V/_hG \\ & & \downarrow \rho \\ & & \overline{WG} \end{array} .$$

By example 3.6.206 this is a presentation for the *universal ρ -associated V -bundle*.

We now spell out what this means in the presentation.

Lemma 3.6.214. *The morphism $V/_hG \rightarrow \overline{WG}$ is a local fibration.*

Proof. By the same argument as in the proof of theorem 3.6.194. □

Proposition 3.6.215. *Let $P \rightarrow X$ in $\mathrm{sSh}(C)_{\mathrm{lfb}}$ be a weakly G -principal bundle with classifying cocycle $X \xrightarrow{\sim} \hat{X} \xrightarrow{g} \overline{WG}$. Then the corresponding ρ -associated ∞ -bundle, def. 3.6.206, is presented by the ordinary V -associated bundle $P \times_G V$ formed in $\mathrm{sSh}(C)_{\mathrm{lfb}}$.*

Proof. By def. 3.6.206 the associated ∞ -bundle is the ∞ -pullback of $V//G \rightarrow \mathbf{BG}$ along g . Using lemma 3.6.214 in prop. 2.3.12 we find that this is presented already by the ordinary pullback of $V/_hG \rightarrow \overline{WG}$ along g . By prop. 3.6.175 this in turn is isomorphic to the pullback of $V \times_G WG \rightarrow \overline{WG}$. Since $\mathrm{sSh}(C)$ is a 1-topos, pullbacks preserve quotients, and so this pullback finally is

$$g^*(WG \times_G V) \simeq (g^*WG) \times_G V \simeq P \times_G WG .$$

□

3.6.12 Sections and twisted cohomology

We discuss here how the general notion of cohomology in an ∞ -topos considered above in 3.6.9, already subsumes the notion of *twisted cohomology* and we discuss the corresponding geometric structure classified by twisted cohomology: *twisted ∞ -bundles*.

Where ordinary cohomology is given by a derived hom- ∞ -groupoid, twisted cohomology is given by the ∞ -groupoid of *sections of a local coefficient bundle* in an ∞ -topos. This is a geometric and unstable variant of the picture of twisted cohomology developed in [ABG10a] [MaSi07]. It is fairly immediate that given a *universal coefficient bundle*, the induced twisted cohomology is equivalently the ordinary cohomology in the corresponding slice ∞ -topos. This identification provides a clean formulation of the contravariance of twisted cocycles. Finally, we observe that twisted cohomology in an ∞ -topos equivalently classifies extensions of structure groups of principal ∞ -bundles.

This section draws from [NSS12a] and [NSS12b].

3.6.12.1 General abstract

Definition 3.6.216. Let $p : E \rightarrow X$ be any morphism in \mathbf{H} , to be regarded as an ∞ -bundle over X . A *section* of E is a diagram

$$\begin{array}{ccc} & & E \\ & \nearrow \sigma & \downarrow p \\ X & \xrightarrow{\text{id}} & X \end{array}$$

$\Downarrow \simeq$

(where for emphasis we display the presence of the homotopy filling the diagram). The ∞ -groupoid of *sections* of $E \xrightarrow{p} X$ is the homotopy fiber

$$\Gamma_X(E) := \mathbf{H}(X, E) \times_{\mathbf{H}(X, X)} \{\text{id}_X\}$$

of the space of all morphisms $X \rightarrow E$ on those that cover the identity on X .

We record two elementary but important observations about spaces of sections.

Observation 3.6.217. There is a canonical identification

$$\Gamma_X(E) \simeq \mathbf{H}_{/X}(\text{id}_X, p)$$

of the space of sections of $E \rightarrow X$ with the hom- ∞ -groupoid in the slice ∞ -topos $\mathbf{H}_{/X}$ between the identity on X and the bundle map p .

Proof. By prop. 3.6.5. □

Lemma 3.6.218. *Let*

$$\begin{array}{ccc} E_1 & \longrightarrow & E_2 \\ \downarrow p_1 & & \downarrow p_2 \\ B_1 & \xrightarrow{f} & B_2 \end{array}$$

be an ∞ -pullback diagram in \mathbf{H} and let $X \xrightarrow{g_X} B_1$ be any morphism. Then post-composition with f induces a natural equivalence of hom- ∞ -groupoids

$$\mathbf{H}_{/B_1}(g_X, p_1) \simeq \mathbf{H}_{/B_2}(f \circ g_X, p_2).$$

Proof. By Proposition 3.6.5, the left hand side is given by the homotopy pullback

$$\begin{array}{ccc} \mathbf{H}_{/B_1}(g_X, p_1) & \longrightarrow & \mathbf{H}(X, E_1) \\ \downarrow & & \downarrow \mathbf{H}(X, p_1) \\ \{g_X\} & \longrightarrow & \mathbf{H}(X, B_1). \end{array}$$

Since the hom- ∞ -functor $\mathbf{H}(X, -) : \mathbf{H} \rightarrow \text{Grpd}_\infty$ preserves the ∞ -pullback $E_1 \simeq f^*E_2$, this extends to a pasting of ∞ -pullbacks, which by the pasting law (Proposition 2.3.2) is

$$\begin{array}{ccccc} \mathbf{H}_{/B_1}(g_X, p_1) & \longrightarrow & \mathbf{H}(X, E_1) & \longrightarrow & \mathbf{H}(X, E_2) \\ \downarrow & & \downarrow \mathbf{H}(X, p_1) & & \downarrow \mathbf{H}(X, p_2) \\ \{g_X\} & \longrightarrow & \mathbf{H}(X, B_1) & \xrightarrow{\mathbf{H}(X, f)} & \mathbf{H}(X, B_2) \end{array} \simeq \begin{array}{ccc} \mathbf{H}_{/B_2}(f \circ g_X, p_2) & \longrightarrow & \mathbf{H}(X, E_2) \\ \downarrow & & \downarrow \mathbf{H}(X, p_2) \\ \{f \circ g_X\} & \longrightarrow & \mathbf{H}(X, B_2). \end{array}$$

□

Fix now an ∞ -group $G \in \text{Grp}(\mathbf{H})$ and an ∞ -action $\rho : V \times G \rightarrow V$. Write

$$\begin{array}{ccc} V & \longrightarrow & V//G \\ & & \downarrow \mathbf{c} \\ & & \mathbf{B}G \end{array}$$

for the corresponding *universal ρ -associated ∞ -bundle* as discussed in Section 3.6.13.

Proposition 3.6.219. *For $g_X : X \rightarrow \mathbf{B}G$ a cocycle and $P \rightarrow X$ the corresponding G -principal ∞ -bundle according to Theorem 3.6.167, there is a natural equivalence*

$$\Gamma_X(P \times_G V) \simeq \mathbf{H}_{/\mathbf{B}G}(g_X, \mathbf{c})$$

between the space of sections of the corresponding ρ -associated V -bundle (Definition 3.6.202) and the hom- ∞ -groupoid of the slice ∞ -topos of \mathbf{H} over $\mathbf{B}G$, between g_X and \mathbf{c} . Schematically:

$$\left\{ \begin{array}{ccc} & & E \\ & \nearrow \sigma & \downarrow p \\ X & \xrightarrow{\text{id}} & X \end{array} \right\} \simeq \left\{ \begin{array}{ccc} & & V//G \\ & \nearrow \sigma & \downarrow \mathbf{c} \\ X & \xrightarrow{g_X} & \mathbf{B}G \end{array} \right\}$$

Proof. By Observation 3.6.217 and Lemma 3.6.218. □

Observation 3.6.220. If in the above the cocycle g_X is trivializable, in the sense that it factors through the point $* \rightarrow \mathbf{B}G$ (equivalently if its class $[g_X] \in H^1(X, G)$ is trivial) then there is an equivalence

$$\mathbf{H}_{/\mathbf{B}G}(g_X, \mathbf{c}) \simeq \mathbf{H}(X, V).$$

Proof. In this case the homotopy pullback on the right in the proof of Proposition 3.6.219 is

$$\begin{array}{ccccc} \mathbf{H}_{/\mathbf{B}G}(g_X, \mathbf{c}) & \simeq & \mathbf{H}(X, V) & \longrightarrow & \mathbf{H}(X, V//G) \\ & & \downarrow & & \downarrow \mathbf{H}(X, \mathbf{c}) \\ \{g_X\} & \simeq & \mathbf{H}(X, *) & \longrightarrow & \mathbf{H}(X, \mathbf{B}G) \end{array}$$

using that $V \rightarrow V//G \xrightarrow{\mathbf{c}} \mathbf{B}G$ is a fiber sequence by definition, and that $\mathbf{H}(X, -)$ preserves this fiber sequence. □

Remark 3.6.221. Since by Proposition 3.6.161 every cocycle g_X trivializes locally over some cover $U \longrightarrow X$ and equivalently, by Proposition 3.6.208, every ∞ -bundle $P \times_G V$ trivializes locally, Observation 3.6.220 says that elements $\sigma \in \Gamma_X(P \times_G V) \simeq \mathbf{H}_{/\mathbf{B}G}(g_X, \mathbf{c})$ *locally* are morphisms $\sigma|_U : U \rightarrow V$ with values in V . They fail to be so *globally* to the extent that $[g_X] \in H^1(X, G)$ is non-trivial, hence to the extent that $P \times_G V \rightarrow X$ is non-trivial.

This motivates the following definition.

Definition 3.6.222. We say that the ∞ -groupoid $\Gamma_X(P \times_G V) \simeq \mathbf{H}/_{\mathbf{B}G}(g_X, \mathbf{c})$ from Proposition 3.6.219 is the ∞ -groupoid of $[g_X]$ -twisted cocycles with values in V , with respect to the local coefficient ∞ -bundle $V//G \xrightarrow{\mathbf{c}} \mathbf{B}G$.

Accordingly, its set of connected components we call the $[g_X]$ -twisted V -cohomology with respect to the local coefficient bundle \mathbf{c} and write:

$$H^{[g_X]}(X, V) := \pi_0 \mathbf{H}/_{\mathbf{B}G}(g_X, \mathbf{c}).$$

Remark 3.6.223. The perspective that twisted cohomology is the theory of sections of associated bundles whose fibers are classifying spaces is maybe most famous for the case of twisted K-theory, where it was described in this form in [Ros89]. But already the old theory of *ordinary cohomology with local coefficients* is of this form, as is made manifest in [BFG] (we discuss this in detail in [NSS12c]).

A proposal for a comprehensive theory in terms of bundles of topological spaces is in [MaSi07] and a systematic formulation in ∞ -category theory and for the case of multiplicative generalized cohomology theories is in [ABG10a]. The formulation above refines this, unstably, to geometric cohomology theories/(nonabelian) sheaf hypercohomology, hence from bundles of classifying spaces to ∞ -bundles of moduli ∞ -stacks.

A wealth of examples and applications of such geometric nonabelian twisted cohomology of relevance in quantum field theory and in string theory is discussed in 3.9.8.

Remark 3.6.224. Of special interest is the case where V is pointed connected, hence (by Theorem 3.6.113) of the form $V = \mathbf{B}A$ for some ∞ -group A , and so (by Definition 3.6.134) the coefficient for degree-1 A -cohomology, and hence itself (by Theorem 3.6.167) the moduli ∞ -stack for A -principal ∞ -bundles. In this case $H^{[g_X]}(X, \mathbf{B}A)$ is *degree-1 twisted A -cohomology*. Generally, if $V = \mathbf{B}^n A$ it is *degree- n twisted A -cohomology*. In analogy with Definition 3.6.134 this is sometimes written

$$H^{n+[g_X]}(X, A) := H^{[g_X]}(X, \mathbf{B}^n A).$$

Moreover, in this case $V//G$ is itself pointed connected, hence of the form $\mathbf{B}\hat{G}$ for some ∞ -group \hat{G} , and so the universal local coefficient bundle

$$\begin{array}{ccc} \mathbf{B}A & \longrightarrow & \mathbf{B}\hat{G} \\ & & \downarrow \mathbf{c} \\ & & \mathbf{B}G \end{array}$$

exhibits \hat{G} as an *extension of ∞ -groups* of G by A . This case we discuss below in Section 3.6.14.

In this notation the local coefficient bundle \mathbf{c} is left implicit. This convenient abuse of notation is justified to some extent by the fact that there is a *universal local coefficient bundle*:

Example 3.6.225. The classifying morphism of the $\mathbf{Aut}(V)$ -action on some $V \in \mathbf{H}$ from Definition 3.6.209 according to Theorem 3.6.167 yields a local coefficient ∞ -bundle of the form

$$\begin{array}{ccc} V & \longrightarrow & V//\mathbf{Aut}(V) \\ & & \downarrow \\ & & \mathbf{BAut}(V) \end{array}$$

which we may call the *universal local V -coefficient bundle*. In the case that V is pointed connected and hence of the form $V = \mathbf{B}G$

$$\begin{array}{ccc} \mathbf{B}G & \longrightarrow & (\mathbf{B}G)//\mathbf{Aut}(\mathbf{B}G) \\ & & \downarrow \\ & & \mathbf{BAut}(\mathbf{B}G) \end{array}$$

the universal twists of the corresponding twisted G -cohomology are the G - ∞ -gerbes. These we discuss below in section 3.6.15.

We now internalize the formulation of spaces of sections, to obtain objects of sections in the ambient ∞ -topos.

Definition 3.6.226. For $p : E \rightarrow X$ a ρ -associated V -fiber bundle, its object of sections is the dependent product, def. 3.6.2:

$$\Gamma_X(E) \simeq \prod_X p.$$

Proposition 3.6.227. For $p : E \rightarrow X$ a ρ -associated V -fiber bundle, its object of sections is equivalently given by

$$\Gamma_X(E) \simeq \prod_{\mathbf{BG}} [g, \rho],$$

where $g : X \rightarrow \mathbf{BG}$ is the modulus of the G -principal bundle to which E is associated.

Proof. By functoriality we have

$$\begin{aligned} \prod_X g^* \rho &\simeq \prod_{\mathbf{BG}} \prod_g g^* \rho \\ &\simeq \prod_{\mathbf{BG}} [g, \rho] \end{aligned},$$

where the second step is prop. 3.6.15. □

3.6.12.2 Presentations

Remark 3.6.228. When the ∞ -topos \mathbf{H} is presented by a model structure on simplicial presheaves as in 2.2.3 and presentations for X and C have been chosen, then the cocycle ∞ -groupoid $\mathbf{H}(X, C)$ is presented by an explicit simplicial set $\mathbf{H}(X, C)_{\text{simp}} \in \text{sSet}$. Once these choices are made, there is therefore the inclusion of simplicial presheaves

$$\text{const}(\mathbf{H}(X, C)_{\text{simp}})_0 \rightarrow \mathbf{H}(X, C)_{\text{simp}},$$

where on the left we have the simplicially constant object on the vertices of $\mathbf{H}(X, C)_{\text{simp}}$. This morphism, in turn, presents a morphism in ∞Grpd that in general contains a multitude of copies of the components of any $H(X, C) \rightarrow \mathbf{H}(X, C)$, a multitude of representatives of twists for each cohomology class of twists. Since the twisted cohomology does not depend, up to equivalence, on the choice of representative of the twist, the corresponding ∞ -pullback yields in general a larger coproduct of ∞ -groupoids as the corresponding twisted cohomology. This however just contains copies of the homotopy types already present in $\mathbf{H}_{\text{tw}}(X, A)$ as defined above and therefore constitutes no additional information.

However, the choice of effective epimorphism $H(X, C) \rightarrow \mathbf{H}(X, C)$, while unique up to equivalence, can usually not be made functorially in X . Therefore twisted cohomology can have a *representing object* only if one does consider multiple twist representatives in a suitable way. An example of this situation appears in the discussion of differential cohomology below in 3.9.6.

3.6.13 Representations and group cohomology

We further discuss the notion of representations/actions/modules of ∞ -groups in an ∞ -topos and the related notions of quotients, invariants and group cohomology

3.6.13.1 General abstract. Let $G \in \text{Grp}(\mathbf{H})$ be a group object. By the discussion in 3.6.11 we may identify the slice ∞ -topos over its delooping with the ∞ -category of G -actions:

Proposition 3.6.229. *We have an equivalence of ∞ -categories*

$$G\text{Act} \simeq \mathbf{H}/_{\mathbf{B}G},$$

under which an action of G on some $V \in \mathbf{H}$ is identified with a morphism $V//G \rightarrow \mathbf{B}G$, regarded as an object in $\mathbf{H}/_{\mathbf{B}G}$, whose ∞ -fiber is V :

$$V \longrightarrow V//G \longrightarrow \mathbf{B}G .$$

It is useful to identify the structure seen here more formally: write

$$\begin{array}{ccc} & \xrightarrow{\Sigma_{\mathbf{B}G}} & \\ \mathbf{H}/_{\mathbf{B}G} & \xleftarrow{(\mathbf{B}G) \times (-)} & \mathbf{H} \\ & \xrightarrow{\prod_{\mathbf{B}G}} & \end{array}$$

for the induced étale geometric morphism, prop. 3.6.13. We introduce some basic terminology on G -actions and analyze some properties.

Definition 3.6.230. For $\rho \in \mathbf{H}/_{\mathbf{B}G}$ a G -action on some $V \in \mathbf{H}$, we say that

1. its dependent sum $\sum_{\mathbf{B}G} \rho \in \mathbf{H}$ is the *quotient object* of the action;
2. its dependent product $\prod_{\mathbf{B}G} \rho \in \mathbf{H}$ is the *object of invariants* of the action.

Moreover, for $V \in \mathbf{H}$ any object, we say that $(\mathbf{B}G)^*V \in \mathbf{H}/_{\mathbf{B}G}$ is the *trivial action* of G on V . .

Proposition 3.6.231. *1. The quotient object in the sense of def. 3.6.230 coincides with the quotient in the sense of def. 3.6.202:*

$$\sum_{\mathbf{B}G} \rho \simeq V//G .$$

2. *The object of invariants coincides with the object of sections of the universal V -associated bundle, def. 3.6.219:*

$$\prod_{\mathbf{B}G} \rho \simeq \Gamma_{\mathbf{B}G}(V//G) .$$

Definition 3.6.232. For $\rho_1, \rho_2 \in \mathbf{H}/_{\mathbf{B}G}$ two G -actions on objects $V_1, V_2 \in \mathbf{H}$, respectively, write $[\rho_1, \rho_2] \in \mathbf{H}/_{\mathbf{B}G}$ for their internal hom in the slice. This we call the *conjugation action* of G on morphisms $V_1 \rightarrow V_2$. We say its direct image under the above étale geometric morphism is the object of *action homomorphisms* and write

$$\mathbf{Hom}_G(\rho_1, \rho_2) := \prod_{\mathbf{B}G} [\rho_1, \rho_2] \in \mathbf{H} .$$

Remark 3.6.233. In words this says that a G -action homomorphism is a morphism $V_1 \rightarrow V_2$ which is an invariant (up to homotopy) of the conjugation action of G .

Proposition 3.6.234. *The conjugation action $[\rho_1, \rho_2]$, def. 3.6.232, is a G -action on the internal hom object $[V_1, V_2] \in \mathbf{H}$.*

Proof. By def. 3.6.202 we need to show that the internal hom $[\rho_1, \rho_2]$ in the slice sits in a fiber sequence in \mathbf{H} of the form

$$\begin{array}{ccc} [V_1, V_2] & \longrightarrow & \sum_{\mathbf{B}G} [\rho_1, \rho_2] . \\ & & \downarrow \\ & & \mathbf{B}G \end{array}$$

Observe that forming the homotopy fiber is applying the inverse image of base change along the point inclusion $\text{pt}_{\mathbf{B}G} : * \rightarrow \mathbf{B}G$ and that base change inverse images are cartesian closed functors¹¹, hence preserve fibers. Using this we compute

$$\begin{aligned} (\text{pt}_{\mathbf{B}G})^*[\rho_1, \rho_2] &\simeq [(\text{pt}_{\mathbf{B}G})^*(V_1, \rho_1), (\text{pt}_{\mathbf{B}G})^*(V_2, \rho_2)] \\ &\simeq [V_1, V_2] \end{aligned}$$

□

Definition 3.6.235. For $G_1, G_2 \in \text{Grp}(\mathbf{H})$ two groups and $f : G_1 \rightarrow G_2$ a group homomorphism, hence $\mathbf{B}f : \mathbf{B}G_1 \rightarrow \mathbf{B}G_2$ a morphism in \mathbf{H} we say that

1. the base change

$$(\mathbf{B}f)^* : \text{Act}(G_2) \simeq \mathbf{H}/_{\mathbf{B}G_2} \longrightarrow \mathbf{H}/_{\mathbf{B}G_1} \simeq \text{Act}(G_1)$$

is the *pullback representation* functor (or *restricted representation* functor if f is a monomorphism);

2. the dependent sum

$$\sum_{\mathbf{B}f} : \text{Act}(G_1) \simeq \mathbf{H}/_{\mathbf{B}G_1} \longrightarrow \mathbf{H}/_{\mathbf{B}G_2} \simeq \text{Act}(G_2)$$

is the *induced representation* functor.

3. the dependent product

$$\prod_{\mathbf{B}f} : \text{Act}(G_1) \simeq \mathbf{H}/_{\mathbf{B}G_1} \longrightarrow \mathbf{H}/_{\mathbf{B}G_2} \simeq \text{Act}(G_2)$$

is the *coinduced representation* functor.

Remark 3.6.236. For the case of permutation representations of discrete groups, this identification of dependent sum/dependent product along contexts of pointed connected discrete groupoids has been mentioned on p. 14 of [Law06].

Example 3.6.237. For $X \in \mathbf{H}$ any object, the automorphism group $\mathbf{Aut}(X)$ of def. 3.6.209 has a canonical action $\rho_{\mathbf{aut}(X)}$ on X , given by the pasting of ∞ -pullback diagrams

$$\begin{array}{ccccc} X & \longrightarrow & V//\mathbf{Aut}(X) & \longrightarrow & \widehat{\text{Obj}} \\ \downarrow & & \downarrow \rho_{\mathbf{aut}(X)} & & \downarrow \\ * & \longrightarrow & \mathbf{BAut}(X) & \hookrightarrow & \text{Obj} \\ & \searrow & \downarrow \vdash X & \nearrow & \\ & & & & \end{array},$$

where the morphism on the right is the universal small object bundle.

Example 3.6.238. For $X, Y \in \mathbf{H}$ two objects, the automorphism group $\mathbf{Aut}(X)$ of X , def. 3.6.209 has a canonical action ρ_{prec} by *precomposition* on the internal hom $[X, Y] \in \mathbf{H}$, given itself by the internal hom

$$\rho_{\text{prec}} := [\rho_{\mathbf{aut}(X)}, \mathbf{BAut}(X)^*Y]$$

¹¹Thanks to Mike Shulman for discussion of this point.

in $\text{Act}(\mathbf{Aut}(X))$, hence by the conjugation action on morphisms from X to Y with Y regarded as equipped with the trivial $\mathbf{Aut}(X)$ -action; we have a fiber sequence

$$\begin{array}{ccc} [X, Y] & \longrightarrow & [X, Y] // \mathbf{Aut}(X) \\ & & \downarrow \rho_{\text{prec}} \\ & & \mathbf{BAut}(X) \end{array}$$

in \mathbf{H} .

Definition 3.6.239. For $*$ the point equipped with the (necessarily) trivial G -action, and for $(V, \rho) \in \mathbf{H}/\mathbf{BG}$ we say that

$$\mathbf{Hom}_G(*, V) \in \mathbf{H}$$

is the *cocycle* ∞ -groupoid of G -group cohomology with coefficients in V . We say that

$$H_{\text{Grp}}(G, V) := \pi_0 \mathbf{Hom}_G(*, V)$$

is the *group cohomology* of G with coefficients in V .

Remark 3.6.240. By remark 3.6.233 and since the action on $*$ is trivial, this says in words that group cohomology with coefficients in V is the collection of equivalence classes of invariants of V .

3.6.13.2 Presentations.

Remark 3.6.241. In the case that $V \in \mathbf{H}$ is presented by a chain complex under the Dold-Kan correspondence, def. 2.2.31 and that $G \in \text{Grp}(\mathbf{H})$ is a 0-truncated group, def. 3.6.239 of group cohomology of G with coefficients in V manifestly reduces to the traditional definition of group cohomology in homological algebra, given by the derived functor of the invariants functor of G -modules.

3.6.14 Extensions and twisted bundles

We discuss the notion of *extensions* of ∞ -groups (see Section 3.6.8), generalizing the traditional notion of group extensions. This is in fact a special case of the notion of principal ∞ -bundle, Definition 3.6.152, for base space objects that are themselves deloopings of ∞ -groups. For every extension of ∞ -groups, there is the corresponding notion of *lifts of structure ∞ -groups* of principal ∞ -bundles. These are classified equivalently by trivializations of an *obstruction class* and by the twisted cohomology with coefficients in the extension itself, regarded as a local coefficient ∞ -bundle.

Moreover, we show that principal ∞ -bundles with an extended structure ∞ -group are equivalent to principal ∞ -bundles with unextended structure ∞ -group but carrying a principal ∞ -bundle for the *extending* ∞ -group on their total space, which on fibers restricts to the given ∞ -group extension. We formalize these *twisted (principal) ∞ -bundles* and observe that they are classified by twisted cohomology, Definition 3.6.222.

Definition 3.6.242. We say a sequence of ∞ -groups,

$$A \rightarrow \hat{G} \rightarrow G$$

in $\text{Grp}(\mathbf{H})$ exhibits \hat{G} as an *extension of G by A* if the delooping

$$\mathbf{BA} \rightarrow \mathbf{B}\hat{G} \rightarrow \mathbf{B}G$$

is a fiber sequence in \mathbf{H} , def. 3.6.138.

Remark 3.6.243. By continuing the fiber sequence to the left

$$A \rightarrow \hat{G} \rightarrow G \rightarrow \mathbf{B}A \rightarrow \mathbf{B}\hat{G} \rightarrow \mathbf{B}G$$

this implies by theorem 3.6.167 that $\hat{G} \rightarrow G$ is an A -principal bundle and that

$$G \simeq \hat{G} \rightarrow A$$

is the quotient of the A -action.

Definition 3.6.244. For A a braided ∞ -group, def. 3.6.116, a *central extension* \hat{G} of G by A is an extension $A \rightarrow \hat{G} \rightarrow G$, such that the defining delooping extends one step further to the right:

$$\mathbf{B}A \longrightarrow \mathbf{B}\hat{G} \xrightarrow{\mathbf{p}} \mathbf{B}G \xrightarrow{\mathbf{c}} \mathbf{B}^2A.$$

We write

$$\mathrm{Ext}(G, A) := \mathbf{H}(\mathbf{B}G, \mathbf{B}^2A) \simeq (\mathbf{B}A)\mathrm{Bund}(\mathbf{B}G)$$

for the ∞ -groupoid of extensions of G by A .

Definition 3.6.245. Given an ∞ -group extension $A \longrightarrow \hat{G} \xrightarrow{\Omega\mathbf{c}} G$ and given a G -principal ∞ -bundle $P \rightarrow X$ in \mathbf{H} , we say that a *lift* \hat{P} of P to a \hat{G} -principal ∞ -bundle is a lift \hat{g}_X of its classifying cocycle $g_X : X \rightarrow \mathbf{B}G$, under the equivalence of Theorem 3.6.167, through the extension:

$$\begin{array}{ccc} & & \mathbf{B}\hat{G} \\ & \nearrow \hat{g}_X & \downarrow \mathbf{p} \\ X & \xrightarrow{g_X} & \mathbf{B}G. \end{array}$$

Accordingly, the ∞ -groupoid of lifts of P with respect to \mathbf{p} is

$$\mathrm{Lift}(P, \mathbf{p}) := \mathbf{H}_{/\mathbf{B}G}(g_X, \mathbf{p}).$$

Observation 3.6.246. By the universal property of the ∞ -pullback, a lift exists precisely if the cohomology class

$$[\mathbf{c}(g_X)] := [\mathbf{c} \circ g_X] \in H^2(X, A)$$

is trivial.

This is implied by Theorem 3.6.248, to which we turn after introducing the following terminology.

Definition 3.6.247. In the above situation, we call $[\mathbf{c}(g_X)]$ the *obstruction class* to the extension; and we call $[\mathbf{c}] \in H^2(\mathbf{B}G, A)$ the *universal obstruction class* of extensions through \mathbf{p} .

We say that a *trivialization* of the obstruction cocycle $\mathbf{c}(g_X)$ is a morphism $\mathbf{c}(g_X) \rightarrow *_X$ in $\mathbf{H}(X, \mathbf{B}^2A)$, where $*_X : X \rightarrow * \rightarrow \mathbf{B}^2A$ is the trivial cocycle. Accordingly, the ∞ -groupoid of trivializations of the obstruction is

$$\mathrm{Triv}(\mathbf{c}(g_X)) := \mathbf{H}_{/\mathbf{B}^2A}(\mathbf{c} \circ g_X, *_X).$$

We give now three different characterizations of spaces of extensions of ∞ -bundles. The first two, by spaces of twisted cocycles and by spaces of trivializations of the obstruction class, are immediate consequences of the previous discussion:

Theorem 3.6.248. Let $P \rightarrow X$ be a G -principal ∞ -bundle corresponding by Theorem 3.6.167 to a cocycle $g_X : X \rightarrow \mathbf{B}G$.

1. There is a natural equivalence

$$\mathrm{Lift}(P, \mathbf{p}) \simeq \mathrm{Triv}(\mathbf{c}(g_X))$$

between the ∞ -groupoid of lifts of P through \mathbf{p} , Definition 3.6.245, and the ∞ -groupoid of trivializations of the obstruction class, Definition 3.6.247.

2. There is a natural equivalence $\mathrm{Lift}(P, \mathbf{p}) \simeq \mathbf{H}/_{\mathbf{B}G}(g_X, \mathbf{p})$ between the ∞ -groupoid of lifts and the ∞ -groupoid of g_X -twisted cocycles relative to \mathbf{p} , Definition 3.6.222, hence a classification

$$\pi_0 \mathrm{Lift}(P, \mathbf{p}) \simeq H^{1+[g_X]}(X, A)$$

of equivalence class of lifts by the $[g_X]$ -twisted A -cohomology of X relative to the local coefficient bundle

$$\begin{array}{ccc} \mathbf{B}A & \longrightarrow & \mathbf{B}\hat{G} \\ & & \downarrow \mathbf{p} \\ & & \mathbf{B}G. \end{array}$$

Proof. The first statement is the special case of Lemma 3.6.218 where the ∞ -pullback $E_1 \simeq f^*E_2$ in the notation there is identified with $\mathbf{B}\hat{G} \simeq \mathbf{c}^{**}$. The second is evident after unwinding the definitions. \square

Remark 3.6.249. For the special case that A is 0-truncated, we may, by the discussion in [NW11a, NSS12c], identify $\mathbf{B}A$ -principal ∞ -bundles with A -bundle gerbes, [Mur96]. Under this identification the ∞ -bundle classified by the obstruction class $[\mathbf{c}(g_X)]$ above is what is called the *lifting bundle gerbe* of the lifting problem, see for instance [CBMMS02] for a review. In this case the first item of Theorem 3.6.248 reduces to Theorem 2.1 in [Wal09] and Theorem A (5.2.3) in [NW11b]. The reduction of this statement to connected components, hence the special case of Observation 3.6.246, was shown in [Br90].

While, therefore, the discussion of extensions of ∞ -groups and of lifts of structure ∞ -groups is just a special case of the discussion in the previous sections, this special case admits geometric representatives of cocycles in the corresponding twisted cohomology by twisted principal ∞ -bundles. This we turn to now.

Definition 3.6.250. Given an extension of ∞ -groups $A \rightarrow \hat{G} \xrightarrow{\Omega \mathbf{c}} G$ and given a G -principal ∞ -bundle $P \rightarrow X$, with class $[g_X] \in H^1(X, G)$, a $[g_X]$ -twisted A -principal ∞ -bundle on X is an A -principal ∞ -bundle $\hat{P} \rightarrow P$ such that the cocycle $q : P \rightarrow \mathbf{B}A$ corresponding to it under Theorem 3.6.167 is a morphism of G - ∞ -actions.

The ∞ -groupoid of $[g_X]$ -twisted A -principal ∞ -bundles on X is

$$\mathrm{ABund}^{[g_X]}(X) := G\mathrm{Action}(P, \mathbf{B}A) \subset \mathbf{H}(P, \mathbf{B}A).$$

Observation 3.6.251. Given an ∞ -group extension $A \rightarrow \hat{G} \xrightarrow{\Omega \mathbf{c}} G$, an extension of a G -principal ∞ -bundle $P \rightarrow X$ to a \hat{G} -principal ∞ -bundle, Definition 3.6.245, induces an A -principal ∞ -bundle $\hat{P} \rightarrow P$ fitting into a pasting diagram of ∞ -pullbacks of the form

$$\begin{array}{ccccc} \hat{G} & \longrightarrow & \hat{P} & \longrightarrow & * \\ \downarrow \Omega \mathbf{c} & & \downarrow & & \downarrow \\ G & \longrightarrow & P & \xrightarrow{q} & \mathbf{B}A & \longrightarrow & * \\ \downarrow & & \downarrow & & \downarrow & & \downarrow \\ * & \xrightarrow{x} & X & \xrightarrow{\hat{g}} & \mathbf{B}\hat{G} & \xrightarrow{\mathbf{c}} & \mathbf{B}G. \\ & & & \searrow \hat{g} & & & \\ & & & & & & g \end{array}$$

In particular, it has the following properties:

1. $\hat{P} \rightarrow P$ is a $[g_X]$ -twisted A -principal bundle, Definition 3.6.250;
2. for all points $x : * \rightarrow X$ the restriction of $\hat{P} \rightarrow P$ to the fiber P_x is equivalent to the ∞ -group extension $\hat{G} \rightarrow G$.

Proof. This follows from repeated application of the pasting law for ∞ -pullbacks, Proposition 2.3.2.

The bottom composite $g : X \rightarrow \mathbf{B}G$ is a cocycle for the given G -principal ∞ -bundle $P \rightarrow X$ and it factors through $\hat{g} : X \rightarrow \mathbf{B}\hat{G}$ by assumption of the existence of the extension $\hat{P} \rightarrow P$.

Since also the bottom right square is an ∞ -pullback by the given ∞ -group extension, the pasting law asserts that the square over \hat{g} is also an ∞ -pullback, and then that so is the square over g . This exhibits \hat{P} as an A -principal ∞ -bundle over P classified by the cocycle q on P . By Proposition 3.6.252 this $\hat{P} \rightarrow P$ is twisted G -equivariant.

Now choose any point $x : * \rightarrow X$ of the base space as on the left of the diagram. Pulling this back upwards through the diagram and using the pasting law and the definition of loop space objects $G \simeq \Omega \mathbf{B}G \simeq * \times_{\mathbf{B}G} *$ the diagram completes by ∞ -pullback squares on the left as indicated, which proves the claim. \square

Theorem 3.6.252. *The construction of Observation 3.6.251 extends to an equivalence of ∞ -groupoids*

$$\mathbf{ABund}^{[g_X]}(X) \simeq \mathbf{H}_{/\mathbf{B}G}(g_X, \mathbf{c})$$

between that of $[g_X]$ -twisted A -principal bundles on X , Definition 3.6.250, and the cocycle ∞ -groupoid of degree-1 $[g_X]$ -twisted A -cohomology, Definition 3.6.222.

In particular the classification of $[g_X]$ -twisted A -principal bundles is

$$\mathbf{ABund}^{[g_X]}(X)_{/\sim} \simeq H^{1+[g_X]}(X, A).$$

Proof. For $G = *$ the trivial group, the statement reduces to Theorem 3.6.167. The general proof works along the same lines as the proof of that theorem. The key step is the generalization of the proof of Proposition 3.6.163. This proceeds verbatim as there, only with $\text{pt} : * \rightarrow \mathbf{B}G$ generalized to $i : \mathbf{B}A \rightarrow \mathbf{B}\hat{G}$. The morphism of G -actions $P \rightarrow \mathbf{B}A$ and a choice of effective epimorphism $U \rightarrow X$ over which $P \rightarrow X$ trivializes gives rise to a morphism in $\mathbf{H}_{/(* \rightarrow \mathbf{B}G)}^{\Delta[1]}$ which involves the diagram

$$\begin{array}{ccc} U \times G & \twoheadrightarrow & P & \longrightarrow & \mathbf{B}A & & U \times G & \twoheadrightarrow & \mathbf{B}A \\ \downarrow & & \downarrow & & \downarrow i & \simeq & \downarrow & & \downarrow i \\ U & \twoheadrightarrow & X & \longrightarrow & \mathbf{B}\hat{G} & & U & \longrightarrow & * & \xrightarrow{\text{pt}} & \mathbf{B}\hat{G} \end{array}$$

in \mathbf{H} . (We are using that for the 0-connected object $\mathbf{B}\hat{G}$ every morphism $* \rightarrow \mathbf{B}G$ factors through $\mathbf{B}\hat{G} \rightarrow \mathbf{B}G$.) Here the total rectangle and the left square on the left are ∞ -pullbacks, and we need to show that the right square on the left is then also an ∞ -pullback. Notice that by the pasting law the rectangle on the right is indeed equivalent to the pasting of ∞ -pullbacks

$$\begin{array}{ccccc} U \times G & \longrightarrow & G & \longrightarrow & \mathbf{B}A \\ \downarrow & & \downarrow & & \downarrow i \\ U & \longrightarrow & * & \xrightarrow{\text{pt}} & \mathbf{B}\hat{G} \end{array}$$

so that the relation

$$U^{\times_X^{n+1}} \times G \simeq i^*(U^{\times_X^{n+1}})$$

holds. With this the proof finishes as in the proof of Proposition 3.6.163, with pt^* generalized to i^* . \square

Remark 3.6.253. Aspects of special cases of this theorem can be identified in the literature. For the special case of ordinary extensions of ordinary Lie groups, the equivalence of the corresponding extensions of a principal bundle with certain equivariant structures on its total space is essentially the content of [Mac88, An04]. In particular the twisted unitary bundles or *gerbe modules* of twisted K-theory [CBMMS02] are equivalent to such structures.

For the case of $\mathbf{BU}(1)$ -extensions of Lie groups, such as the String-2-group, the equivalence of the corresponding String-principal 2-bundles, by the above theorem, to certain bundle gerbes on the total spaces of principal bundles underlies constructions such as in [Redd06]. Similarly the bundle gerbes on double covers considered in [SSW05] are $\mathbf{BU}(1)$ -principal 2-bundles on \mathbb{Z}_2 -principal bundles arising by the above theorem from the extension $\mathbf{BU}(1) \rightarrow \mathbf{Aut}(\mathbf{BU}(1)) \rightarrow \mathbb{Z}_2$, a special case of the extensions that we consider in the next Section 3.6.15.

These and more examples we discuss in detail below.

3.6.15 Gerbes

We discuss the general notion of (nonabelian) *gerbes* and higher gerbes in an ∞ -topos.

This section draws from [NSS12a].

Remark 3.6.224 above indicates that of special relevance are those V -fiber ∞ -bundles $E \rightarrow X$ in an ∞ -topos \mathbf{H} whose typical fiber V is pointed connected, and hence is the moduli ∞ -stack $V = \mathbf{BG}$ of G -principal ∞ -bundles for some ∞ -group G . Due to their local triviality, when regarded as objects in the slice ∞ -topos $\mathbf{H}/_X$, these \mathbf{BG} -fiber ∞ -bundles are themselves *connected objects*. Generally, for \mathcal{X} an ∞ -topos regarded as an ∞ -topos of ∞ -stacks over a given space X , it makes sense to consider its connected objects as ∞ -bundles over X . Here we discuss these ∞ -gerbes.

In the following discussion it is useful to consider two ∞ -toposes:

1. an “ambient” ∞ -topos \mathbf{H} as before, to be thought of as an ∞ -topos “of all geometric homotopy types” for a given notion of geometry, in which ∞ -bundles are given by *morphisms* and the terminal object plays the role of the geometric point $*$;
2. an ∞ -topos \mathcal{X} , to be thought of as the topos-theoretic incarnation of a single geometric homotopy type (space) X , hence as an ∞ -topos of “geometric homotopy types étale over X ”, in which an ∞ -bundle over X is given by an *object* and the terminal object plays the role of the base space X .

In practice, \mathcal{X} is the slice $\mathbf{H}/_X$ of the previous ambient ∞ -topos over $X \in \mathbf{H}$, or the smaller ∞ -topos $\mathcal{X} = \mathbf{Sh}_\infty(X)$ of (internal) ∞ -stacks over X .

In topos-theory literature the role of \mathbf{H} above is sometimes referred to as that of a *gros* topos and then the role of \mathcal{X} is referred to as that of a *petit* topos. The reader should beware that much of the classical literature on gerbes is written from the point of view of only the *petit* topos \mathcal{X} .

The original definition of a *gerbe* on X [Gir71] is: a stack E (i.e. a 1-truncated ∞ -stack) over X that is 1. *locally non-empty* and 2. *locally connected*. In the more intrinsic language of higher topos theory, these two conditions simply say that E is a *connected object* (Definition 6.5.1.10 in [L-Topos]): 1. the terminal morphism $E \rightarrow *$ is an effective epimorphism and 2. the 0th homotopy sheaf is trivial, $\pi_0(E) \simeq *$. This reformulation is made explicit in the literature for instance in Section 5 of [JaLu04] and in Section 7.2.2 of [L-Topos]. Therefore:

Definition 3.6.254. For \mathcal{X} an ∞ -topos, a *gerbe* in \mathcal{X} is an object $E \in \mathcal{X}$ which is

1. connected;
2. 1-truncated.

For $X \in \mathbf{H}$ an object, a *gerbe E over X* is a gerbe in the slice $\mathbf{H}/_X$. This is an object $E \in \mathbf{H}$ together with an effective epimorphism $E \rightarrow X$ such that $\pi_i(E) = X$ for all $i \neq 1$.

Remark 3.6.255. Notice that conceptually this is different from the notion of *bundle gerbe* introduced in [Mur96] (see [NW11a] for a review). We discuss in [NSS12c] that bundle gerbes are presentations of *principal* ∞ -bundles (Definition 3.6.152). But gerbes – at least the *G-gerbes* considered in a moment in Definition 3.6.261 – are *V-fiber* ∞ -bundles (Definition 3.6.201) hence *associated* to principal ∞ -bundles (Proposition 3.6.210) with the special property of having pointed connected fibers. By Theorem 3.6.211 *V-fiber* ∞ -bundles may be identified with their underlying $\mathbf{Aut}(V)$ -principal ∞ -bundles and so one may identify *G-gerbes* with nonabelian $\mathbf{Aut}(\mathbf{BG})$ -bundle gerbes (see also around Proposition 3.6.264 below), but considered generally, neither of these two notions is a special case of the other. Therefore the terminology is slightly unfortunate, but it is standard.

Definition 3.6.254 has various obvious generalizations. The following is considered in [L-Topos].

Definition 3.6.256. For $n \in \mathbb{N}$, an *EM n-gerbe* is an object $E \in \mathcal{X}$ which is

1. $(n - 1)$ -connected;
2. n -truncated.

Remark 3.6.257. This is almost the definition of an *Eilenberg-Mac Lane object* in \mathcal{X} , only that the condition requiring a global section $* \rightarrow E$ (hence $X \rightarrow E$) is missing. Indeed, the Eilenberg-Mac Lane objects of degree n in \mathcal{X} are precisely the EM n -gerbes of *trivial class*, according to Proposition 3.6.264 below.

There is also an earlier established definition of *2-gerbes* in the literature [Br94], which is more general than EM 2-gerbes. Stated in the above fashion it reads as follows.

Definition 3.6.258 (Breen [Br94]). A *2-gerbe* in \mathcal{X} is an object $E \in \mathcal{X}$ which is

1. connected;
2. 2-truncated.

This definition has an evident generalization to arbitrary degree, which we adopt here.

Definition 3.6.259. An *n-gerbe* in \mathcal{X} is an object $E \in \mathcal{X}$ which is

1. connected;
2. n -truncated.

In particular an ∞ -gerbe is a connected object.

The real interest is in those ∞ -gerbes which have a prescribed typical fiber:

Remark 3.6.260. By the above, ∞ -gerbes (and hence EM n -gerbes and 2-gerbes and hence gerbes) are much like deloopings of ∞ -groups (Theorem 3.6.113) only that there is no requirement that there exists a global section. An ∞ -gerbe for which there exists a global section $X \rightarrow E$ is called *trivializable*. By Theorem 3.6.113 trivializable ∞ -gerbes are equivalent to ∞ -group objects in \mathcal{X} (and the ∞ -groupoids of all of these are equivalent when transformations are required to preserve the canonical global section).

But *locally* every ∞ -gerbe E is of this form. For let

$$(x^* \dashv x_*) : \mathbf{Grpd}_\infty \begin{array}{c} \xleftarrow{x^*} \\ \xrightarrow{x_*} \end{array} \mathcal{X}$$

be a topos point. Then the stalk $x^*E \in \mathbf{Grpd}_\infty$ of the ∞ -gerbe is connected: because inverse images preserve the finite ∞ -limits involved in the definition of homotopy sheaves, and preserve the terminal object. Therefore

$$\pi_0 x^*E \simeq x^* \pi_0 E \simeq x^* * \simeq *.$$

Hence for every point x we have a stalk ∞ -group G_x and an equivalence

$$x^*E \simeq \mathbf{BG}_x.$$

Therefore one is interested in the following notion.

Definition 3.6.261. For $G \in \text{Grp}(\mathcal{X})$ an ∞ -group object, a G - ∞ -gerbe is an ∞ -gerbe E such that there exists

1. an effective epimorphism $U \twoheadrightarrow X$;
2. an equivalence $E|_U \simeq \mathbf{B}G|_U$.

Equivalently: a G - ∞ -gerbe is a $\mathbf{B}G$ -fiber ∞ -bundle, according to Definition 3.6.201.

In words this says that a G - ∞ -gerbe is one that locally looks like the moduli ∞ -stack of G -principal ∞ -bundles.

Example 3.6.262. For X a topological space and $\mathcal{X} = \text{Sh}_\infty(X)$ the ∞ -topos of ∞ -sheaves over it, these notions reduce to the following.

- a 0-group object $G \in \tau_0\text{Grp}(\mathcal{X}) \subset \text{Grp}(\mathcal{X})$ is a sheaf of groups on X (here $\tau_0\text{Grp}(\mathcal{X})$ denotes the 0-truncation of $\text{Grp}(\mathcal{X})$);
- for $\{U_i \rightarrow X\}$ any open cover, the canonical morphism $\coprod_i U_i \rightarrow X$ is an effective epimorphism to the terminal object;
- $(\mathbf{B}G)|_{U_i}$ is the stack of $G|_{U_i}$ -principal bundles ($G|_{U_i}$ -torsors).

It is clear that one way to construct a G - ∞ -gerbe should be to start with an $\mathbf{Aut}(\mathbf{B}G)$ -principal ∞ -bundle, Remark 3.6.225, and then canonically *associate* a fiber ∞ -bundle to it.

Example 3.6.263. For $G \in \tau_0\text{Grp}(\text{Grpd}_\infty)$ an ordinary group, $\mathbf{Aut}(\mathbf{B}G)$ is usually called the *automorphism 2-group* of G . Its underlying groupoid is equivalent to

$$\mathbf{Aut}(G) \times G \rightrightarrows \mathbf{Aut}(G),$$

the action groupoid for the action of G on $\mathbf{Aut}(G)$ via the homomorphism $\text{Ad}: G \rightarrow \mathbf{Aut}(G)$.

Corollary 3.6.264. Let \mathcal{X} be a 1-localic ∞ -topos (i.e. one that has a 1-site of definition). Then for $G \in \text{Grp}(\mathcal{X})$ any ∞ -group object, G - ∞ -gerbes are classified by $\mathbf{Aut}(\mathbf{B}G)$ -cohomology:

$$\pi_0 G\text{Gerbe} \simeq \pi_0 \mathcal{X}(X, \mathbf{BAut}(\mathbf{B}G)) =: H_{\mathcal{X}}^1(X, \mathbf{Aut}(\mathbf{B}G)).$$

Proof. This is the special case of Theorem 3.6.211 for $V = \mathbf{B}G$. □
For the case that G is 0-truncated (an ordinary group object) this is the content of Theorem 23 in [JaLu04].

Example 3.6.265. For $G \in \text{Grp}(\mathcal{X}) \subset \tau_{\leq 0}\text{Grp}(\mathcal{X})$ an ordinary 1-group object, this reproduces the classical result of [Gir71], which originally motivated the whole subject: by Example 3.6.263 in this case $\mathbf{Aut}(\mathbf{B}G)$ is the traditional automorphism 2-group and $H_{\mathcal{X}}^1(X, \mathbf{Aut}(\mathbf{B}G))$ is Giraud's nonabelian G -cohomology that classifies G -gerbes (for arbitrary *band*, see Definition 3.6.271 below).

For $G \in \tau_{\leq 1}\text{Grp}(\mathcal{X}) \subset \text{Grp}(\mathcal{X})$ a 2-group, we recover the classification of 2-gerbes as in [Br94, Br06].

Remark 3.6.266. In Section 7.2.2 of [L-Topos] the special case that here we called *EM- n -gerbes* is considered. Beware that there are further differences: for instance the notion of morphisms between n -gerbes as defined in [L-Topos] is more restrictive than the notion considered here. For instance with our definition (and hence also that in [Br94]) each group automorphism of an abelian group object A induces an automorphism of the trivial A -2-gerbe $\mathbf{B}^2 A$. But, except for the identity, this is not admitted in [L-Topos] (manifestly so by the diagram above Lemma 7.2.2.24 there). Accordingly, the classification result in [L-Topos] is different: it involves the cohomology group $H_{\mathcal{X}}^{n+1}(X, A)$. Notice that there is a canonical morphism

$$H_{\mathcal{X}}^{n+1}(X, A) \rightarrow H_{\mathcal{X}}^1(X, \mathbf{Aut}(\mathbf{B}^n A))$$

induced from the morphism $\mathbf{B}^{n+1} A \rightarrow \mathbf{Aut}(\mathbf{B}^n A)$.

We now discuss how the ∞ -group extensions, Definition 3.6.242, given by the Postnikov stages of $\mathbf{Aut}(\mathbf{B}G)$ induces the notion of *band* of a gerbe, and how the corresponding twisted cohomology, according to Remark 3.6.248, reproduces the original definition of nonabelian cohomology in [Gir71] and generalizes it to higher degree.

Definition 3.6.267. Fix $k \in \mathbb{N}$. For $G \in \infty\text{Grp}(\mathcal{X})$ a k -truncated ∞ -group object (a $(k+1)$ -group), write

$$\mathbf{Out}(G) := \tau_k \mathbf{Aut}(\mathbf{B}G)$$

for the k -truncation of $\mathbf{Aut}(\mathbf{B}G)$. (Notice that this is still an ∞ -group, since by Lemma 6.5.1.2 in [L-Topos] τ_n preserves all ∞ -colimits and additionally all products.) We call this the *outer automorphism n -group* of G .

In other words, we write

$$\mathbf{c} : \mathbf{BAut}(\mathbf{B}G) \rightarrow \mathbf{BOut}(G)$$

for the top Postnikov stage of $\mathbf{BAut}(\mathbf{B}G)$.

Example 3.6.268. Let $G \in \tau_0\text{Grp}(\text{Grpd}_\infty)$ be a 0-truncated group object, an ordinary group,. Then by Example 3.6.263, $\mathbf{Out}(G) = \mathbf{Out}(G)$ is the coimage of $\text{Ad} : G \rightarrow \text{Aut}(G)$, which is the traditional group of outer automorphisms of G .

Definition 3.6.269. Write $\mathbf{B}^2\mathbf{Z}(G)$ for the ∞ -fiber of the morphism \mathbf{c} from Definition 3.6.267, fitting into a fiber sequence

$$\begin{array}{ccc} \mathbf{B}^2\mathbf{Z}(G) & \longrightarrow & \mathbf{BAut}(\mathbf{B}G) \ . \\ & & \downarrow \mathbf{c} \\ & & \mathbf{BOut}(G) \end{array}$$

We call $\mathbf{Z}(G)$ the *center* of the ∞ -group G .

Example 3.6.270. For G an ordinary group, so that $\mathbf{Aut}(\mathbf{B}G)$ is the automorphism 2-group from Example 3.6.263, $\mathbf{Z}(G)$ is the center of G in the traditional sense.

By theorem 3.6.264 there is an induced morphism

$$\text{Band} : \pi_0 G\text{Gerbe} \rightarrow H^1(X, \mathbf{Out}(G)).$$

Definition 3.6.271. For $E \in G\text{Gerbe}$ we call $\text{Band}(E)$ the *band* of E .

By using Definition 3.6.269 in Definition 3.6.222, given a band $[\phi_X] \in H^1(X, \mathbf{Out}(G))$, we may regard it as a twist for twisted $\mathbf{Z}(G)$ -cohomology, classifying G -gerbes with this band:

$$\pi_0 G\text{Gerbe}^{[\phi_X]}(X) \simeq H^{2+[\phi_X]}(X, \mathbf{Z}(G)).$$

Remark 3.6.272. The original definition of *gerbe with band* in [Gir71] is slightly more general than that of G -gerbe (with band) in [Br94]: in the former the local sheaf of groups whose delooping is locally equivalent to the gerbe need not descend to the base. These more general Giraud gerbes are 1-gerbes in the sense of Definition 3.6.259, but only the slightly more restrictive G -gerbes of Breen have the good property of being connected fiber ∞ -bundles. From our perspective this is the decisive property of gerbes, and the notion of band is relevant only in this case.

Example 3.6.273. For G a 0-group this reduces to the notion of band as introduced in [Gir71], for the case of G -gerbes as in [Br94].

3.6.16 Relative cohomology

We discuss the notion of *relative cohomology* internal to any ∞ -topos \mathbf{H} .

Definition 3.6.274. Let $i : Y \rightarrow X$ and $f : B \rightarrow A$ be two morphisms in \mathbf{H} . We say that the ∞ -groupoid of *relative cocycles* on i with coefficients in f is the hom ∞ -groupoid $\mathbf{H}^I(i, f)$, where $\mathbf{H}^I := \text{Funct}(\Delta[1], \mathbf{H})$. The corresponding set of equivalence classes / homotopy classes we call the *relative cohomology*

$$H_Y^B(X, A) := \pi_0 \mathbf{H}^I(i, f).$$

When A is understood to be a pointed object, $B = *$ is the terminal object and $f : B \simeq * \rightarrow A$ is the point inclusion, we speak for short of the *cohomology of X with coefficients in A relative to Y* and write

$$H_Y(X, A) := H_Y^*(X, A).$$

Proposition 3.6.275. *The ∞ -groupoid of relative cocycles fits into an ∞ -pullback diagram of the form*

$$\begin{array}{ccc} \mathbf{H}^I(i, f) & \longrightarrow & \mathbf{H}(X, A) \\ \downarrow & & \downarrow i^* \\ \mathbf{H}(Y, B) & \xrightarrow{f_*} & \mathbf{H}(Y, A) \end{array} .$$

Proof. Let C be an ∞ -site of definition of \mathbf{H} and

$$\mathbf{H} \simeq ([C^{\text{op}}, \text{sSet}]_{\text{proj,loc}})^\circ$$

be a presentatin by simplicial presheaves as in 2.2.3. Then \mathbf{H}^I is presented by the, say, Reedy model structure on simplicial functors from $\Delta[1]$ to simplicial presheaves

$$\mathbf{H}^I \simeq ([\Delta[1], [C^{\text{op}}, \text{sSet}]_{\text{proj,loc}}]_{\text{Reedy}})^\circ .$$

We may find for $i : Y \rightarrow X$ in \mathbf{H} a presentation by a cofibration between cofibrant objects in $[C^{\text{op}}, \text{sSet}]_{\text{proj,loc}}$, and similarly for $f : B \rightarrow A$ a presentation by a fibration between fibrant objects. Let these same symbols now denote these presentations. Then i is also cofibrant in the above presentation for \mathbf{H}^I and similarly f is fibrant there.

This implies that the ∞ -categorical hom space in question is given by the hom-simplicial set

$$\mathbf{H}^I(i, f) \simeq [\Delta[1], [C^{\text{op}}, \text{sSet}(i, f)] .$$

This in turn is computed as the 1-categorical pullback of simplicial sets

$$\begin{array}{ccc} [\Delta[1], [C^{\text{op}}, \text{sSet}(i, f)] & \longrightarrow & [C^{\text{op}}, \text{sSet}(X, A)] . \\ \downarrow & & \downarrow i^* \\ [C^{\text{op}}, \text{sSet}(Y, A)] & \xrightarrow{f_*} & [C^{\text{op}}, \text{sSet}(Y, A)] \end{array}$$

Since $[C^{\text{op}}, \text{sSet}]$ is a simplicial model category, and by assumption on our presentations for i and f , here the bottom and the right morphism are Kan fibrations. Therefore by prop. 2.3.8 this presents a homotopy pullback diagram, which proves the claim. \square

Remark 3.6.276. This says in words that a cocycle relative to $Y \rightarrow X$ with coefficients in $B \rightarrow A$ is an A -cocycle on X whose pullback to Y is equipped with a coboundary to a B -cocycle. In particular, in the case that $B \simeq *$ it is an A -cocycle on X equipped with a trivialization of its pullback to Y .

In the case that B is not trivial, this definition of relative cohomology is a generalization of the twisted cohomology discussed in 3.6.12.

Observation 3.6.277. Let $\mathbf{c} : X \rightarrow A$ be a fixed A -cocycle on X . Then the fiber of the ∞ -groupoid of (i, f) -relative cocycles over \mathbf{c} is equivalently the ∞ -groupoid of $[i^*\mathbf{c}]$ -twisted cohomology on Y , according to def. 3.6.222.

Proof. By the pasting law, prop. 2.3.2 the relative cocycles over \mathbf{c} sitting in the top ∞ -pullback square of

$$\begin{array}{ccc} \mathbf{H}^I(i, f)|_{\mathbf{c}} & \longrightarrow & * \\ \downarrow & & \downarrow \mathbf{c} \\ \mathbf{H}^I(i, f) & \longrightarrow & \mathbf{H}(X, A) \\ \downarrow & & \downarrow i^* \\ \mathbf{H}(Y, B) & \xrightarrow{f_*} & \mathbf{H}(Y, A) \end{array}$$

also form the ∞ -pullback of the total rectangle, which is the ∞ -groupoid of $[i^*\mathbf{c}]$ -twisted cocycles on Y . \square

Remark 3.6.278. In the special case that the coefficients B and A have a presentation by sheaves of chain complexes in the image of the Dold-Kan correspondence, prop. 2.2.31, the morphism $i^* : \mathbf{H}(X, A) \rightarrow \mathbf{H}(Y, A)$ has a presentation by a morphism of cochain complexes and the above ∞ -pullback may be computed in terms of the dual mapping cone on this morphism. Specially in the case that $B \simeq *$ the homotopy pullback is presented by that dual mapping cone itself, and hence the relative cohomology is the cochain cohomology of the mapping cone on i^* . In this form relative cohomology is traditionally defined in the literature.

3.7 Structures in a local ∞ -topos

We discuss structures present in a *local ∞ -topos*, def. 3.2.1.

- 3.7.1 – Codiscrete objects;
- 3.7.2 – Concrete objects.

3.7.1 Codiscrete objects

Observation 3.7.1. The cartesian internal hom $[-, -] : \mathbf{H}^{\text{op}} \times \mathbf{H} \rightarrow \mathbf{H}$ is related to the external hom $\mathbf{H}(-, -) : \mathbf{H}^{\text{op}} \times \mathbf{H} \rightarrow \infty\text{Grpd}$ by

$$\mathbf{H}(-, -) \simeq \Gamma[-, -] ..$$

Proof. The ∞ -Yoneda lemma implies, by the same argument as for 1-categorical sheaf toposes, that the internal hom is the ∞ -stack given on any test object U by

$$[X, A](U) \simeq \mathbf{H}(U, [X, A]) \simeq \mathbf{H}(X \times U, A).$$

By prop. 2.2.5 the global section functor Γ is given by evaluation on the point, so that

$$\Gamma([X, A]) \simeq \mathbf{H}(*, [X, A]) \simeq \mathbf{H}(X \times *, A) \simeq \mathbf{H}(X, A).$$

\square

Proposition 3.7.2. *The codiscrete objects in a local ∞ -topos, hence in a cohesive ∞ -topos, \mathbf{H} are stable under internal exponentiation: for all $X \in \mathbf{H}$ and $A \in \infty\text{Grpd}$ we have*

$$[X, \text{coDisc}A] \in \mathbf{H}$$

is codiscrete. Specifically, the internal hom into a codiscrete object is the codiscretification of the external hom

$$[X, \text{coDisc}A] \simeq \text{coDisc}\mathbf{H}(X, \text{coDisc}A).$$

Proof. The internal hom is the ∞ -stack given by the assignment

$$[X, \text{coDisc}A] : U \mapsto \mathbf{H}(X \times U, \text{coDisc}A).$$

By the $(\Gamma \dashv \text{Disc})$ -adjunction the right hand is

$$\simeq \infty\text{Grpd}(\Gamma(X \times U), A).$$

Since Γ is also a right adjoint it preserves the product, so that

$$\cdots \simeq \infty\text{Grpd}(\Gamma(X) \times \Gamma(U), A).$$

Using the cartesian closure of ∞Grpd this is

$$\cdots \simeq \infty\text{Grpd}(\Gamma(U), [\Gamma(X), A]).$$

Using again the $(\Gamma \dashv \text{coDisc})$ -adjunction this is

$$\cdots \simeq \mathbf{H}(U, \text{coDisc}[\Gamma(X), A]).$$

Since all of these equivalence are natural, with the ∞ -Yoneda lemma it finally follows that

$$[X, \text{coDisc}A] \simeq \text{coDisc}\infty\text{Grpd}(\Gamma(X), A) \simeq \text{coDisc}\mathbf{H}(X, \text{coDisc}A).$$

□

3.7.2 Concrete objects

The cohesive structure on an object in a cohesive ∞ -topos need not be supported by points. We discuss a general abstract characterization of objects that do have an interpretation as bare n -groupoids equipped with cohesive structure. Further refinements of these constructions are discussed further below in 3.9.6.4 for objects that serve as moduli of differential cocycles.

The content of this section is partly taken from [CaSc].

3.7.2.1 General abstract

Proposition 3.7.3. *On a cohesive ∞ -topos \mathbf{H} both Disc and coDisc are full and faithful ∞ -functors and coDisc exhibits ∞Grpd as a sub- ∞ -topos of \mathbf{H} by an ∞ -geometric embedding*

$$\infty\text{Grpd} \xleftarrow{\Gamma} \mathbf{H} \xrightarrow{\text{coDisc}}$$

Proof. The full and faithfulness of Disc was shown in prop. 3.3.4 and that for coDisc follows from the same kind of argument. Since Γ is also a right adjoint it preserves in particular finite ∞ -limits, so that $(\Gamma \dashv \text{coDisc})$ is indeed an ∞ -geometric morphism. □

Recall that we write

$$\sharp := \text{coDisc} \circ \Gamma$$

Corollary 3.7.4. *The ∞ -topos ∞Grpd is equivalent to the full sub- ∞ -category of \mathbf{H} on those objects $X \in \mathbf{H}$ for which the canonical morphism $X \rightarrow \sharp X$ is an equivalence.*

Proof. This follows by general facts about reflective sub- ∞ -categories ([L-Topos], section 5.5.4). \square

Proposition 3.7.5. *Let \mathbf{H} be the ∞ -topos over an ∞ -cohesive site C . For a 0-truncated object X in \mathbf{H} the morphism*

$$X \rightarrow \sharp X$$

is a monomorphism precisely if X is a concrete sheaf in the traditional sense of [Dub79].

Proof. Monomorphisms of sheaves are detected objectwise. So by the Yoneda lemma and using the $(\Gamma \dashv \text{coDisc})$ -adjunction we have that $X \rightarrow \text{coDisc } \Gamma X$ is a monomorphism precisely if for all $U \in C$ the morphism

$$X(U) \simeq \mathbf{H}(U, X) \rightarrow \mathbf{H}(U, \text{coDisc } \Gamma X) \simeq \mathbf{H}(\Gamma(U), \Gamma(X))$$

is a monomorphism. This is the traditional definition. \square

Definition 3.7.6. For $X \in \mathbf{H}$, write

$$X =: \sharp_{\infty} X \longrightarrow \cdots \longrightarrow \sharp_2 X \longrightarrow \sharp_1 X \longrightarrow \sharp_0 X := \sharp X$$

for the tower of n -image factorizations, def. 3.6.31, of $X \rightarrow \sharp X$, hence with

$$\sharp_n X := \text{im}_n(X \rightarrow \sharp X)$$

for all $n \in \mathbb{N}$.

Definition 3.7.7. For $n \in \mathbb{N}$ and $X \in \mathbf{H}$ an n -truncated object, we say that $X \rightarrow \sharp_{n+1} X$ is its *n -concretification*. If this is an equivalence we say that X is *n -concrete*.

3.7.2.2 Presentations We discuss presentations of n -concrete objects for low n .

Proposition 3.7.8. *Let C be an ∞ -cohesive site, 3.4.2.1, and let $A \in \text{Sh}_{\infty}(C)$ be a 1-truncated object that has a presentation by a groupoid-valued presheaf on C which is fibrant as a simplicial presheaf. Then it is 1-concrete if in degree 1 this is a concrete sheaf. Moreover, its 1-concretification, def. 3.7.7, has a presentation by a presheaf of groupoids which in degree 1 is a concrete sheaf.*

Proof. Any functor $f : X \rightarrow Y$ between groupoids has a factorization $X \rightarrow \text{im}_1 f \rightarrow Y$, where the groupoid $\text{im}_1 f$ has the same objects as X and has as morphisms equivalence classes $[\xi]$ of morphisms ξ in X under the relation $[\xi_1] = [\xi_2]$ precisely if $f(\xi_1) = f(\xi_2)$. The evident functor $\text{im}_1 f \rightarrow Y$ is manifestly faithful and this factorization is natural. Therefore if now f is a morphism of presheaves of groupoids, it, too, has a factorization which is objectwise of this form.

By the discussion in 3.4.2.1, over an ∞ -cohesive site the units $\eta_X : X \rightarrow \sharp X$ of the $(\Gamma \dashv \text{coDisc})$ - ∞ -adjunction are presented for fibrant simplicial presheaf representatives X by morphisms of simplicial presheaves that object- and degreewise send the value set of a presheaf to the set of concrete values. By the previous paragraph and prop. 3.6.51 it follows that the 1-image factorization $X \rightarrow \text{im}_1 \eta_X \rightarrow \sharp X$ is in the second morphism objectwise a faithful functor. This means that the hom-presheaf $(\text{im}_1 \eta_X)_1$ is a concrete sheaf on C . \square

3.8 Structures in a locally ∞ -connected ∞ -topos

We discuss here homotopical, cohomological and geometrical structures that are canonically present in a locally ∞ -connected ∞ -topos \mathbf{H} , 3.3.1. The existence of the extra left adjoint Π for a locally ∞ -connected ∞ -topos encodes an intrinsic notion of *geometric paths* in the objects of \mathbf{H} .

If \mathbf{H} is in addition *cohesive*, then these Π -geometric structures combine with the cohomological structures of a local ∞ -topos, discussed in 3.7 to produce differential geometry and differential cohomological structures. This we discuss below in 3.9.

- 3.8.1 – Geometric homotopy / Étale homotopy
- 3.8.2 – Concordance
- 3.8.3 – Paths and geometric Postnikov towers
- 3.8.4 – Universal coverings and geometric Whitehead towers
- 3.8.5 – Flat connections and local systems
- 3.8.6 – Galois theory

3.8.1 Geometric homotopy / Étale homotopy

We discuss internal realizations of the notions of *geometric realization*, and *geometric homotopy* in any cohesive ∞ -topos \mathbf{H} .

Definition 3.8.1. For \mathbf{H} a locally ∞ -connected ∞ -topos and $X \in \mathbf{H}$ an object, we call $\Pi(X) \in \infty\text{Grpd}$ the *fundamental ∞ -groupoid* of X .

The ordinary homotopy groups of $\Pi(X)$ we call the *geometric homotopy groups* of X

$$\pi_{\bullet}^{\text{geom}}(X \in \mathbf{H}) := \pi_{\bullet}(\Pi(X \in \infty\text{Grpd})).$$

Definition 3.8.2. For $|-| : \infty\text{Grpd} \xrightarrow{\cong} \text{Top}$ the canonical equivalence of ∞ -toposes, we write

$$|X| := |\Pi X| \in \text{Top}$$

and call this the *geometric realization* of X .

Remark 3.8.3. In presentations of \mathbf{H} by simplicial presheaves, as in prop. 3.4.18, aspects of this abstract notion are more or less implicit in the literature. See for instance around remark 2.22 of [SiTe]. The key insight is already in [ArMa69], if somewhat implicitly. This we discuss in detail in 4.3.4.

In some applications we need the following characterization of geometric homotopies in a cohesive ∞ -topos.

Definition 3.8.4. We say a *geometric homotopy* between two morphisms $f, g : X \rightarrow Y$ in \mathbf{H} is a diagram

$$\begin{array}{ccc} X & & \\ \text{(Id, } i \text{)} \downarrow & \searrow f & \\ X \times I & \xrightarrow{\eta} & Y \\ \text{(Id, } o \text{)} \uparrow & \nearrow g & \\ X & & \end{array}$$

such that I is geometrically connected, $\pi_0^{\text{geom}}(I) = *$.

Proposition 3.8.5. *If two morphism $f, g : X \rightarrow Y$ in a cohesive ∞ -topos \mathbf{H} are geometrically homotopic then their images $\Pi(f), \Pi(g)$ are equivalent in ∞Grpd .*

Proof. By the condition that Π preserves products in a strongly ∞ -connected ∞ -topos we have that the image of the geometric homotopy in ∞Grpd is a diagram of the form

$$\begin{array}{ccc}
 \Pi(X) & & \\
 (\text{Id}, \Pi(i)) \downarrow & \searrow \Pi(f) & \\
 \Pi(X) \times \Pi(I) & \xrightarrow{\Pi(\eta)} & \Pi(Y) \\
 (\text{Id}, \Pi(o)) \uparrow & \nearrow \Pi(g) & \\
 \Pi(X) & &
 \end{array}$$

Since $\Pi(I)$ is connected by assumption, there is a diagram

$$\begin{array}{ccc}
 & * & \\
 & \nearrow & \downarrow \Pi(i) \\
 * & \longrightarrow & \Pi(I) \\
 & \searrow & \uparrow \Pi(o) \\
 & & *
 \end{array}$$

in ∞Grpd (filled with homotopies, which we do not display, as usual, that connect the three points in $\Pi(I)$). Taking the product of this diagram with $\Pi(X)$ and pasting the result to the above image $\Pi(\eta)$ of the geometric homotopy constructs the equivalence $\Pi(f) \Rightarrow \Pi(g)$ in ∞Grpd . \square

We consider a refinement of these kinds of considerations below in 3.9.1.

Proposition 3.8.6. *For \mathbf{H} a locally ∞ -connected ∞ -topos, also all its objects $X \in \mathbf{H}$ are locally ∞ -connected, in the sense that their over- ∞ -toposes \mathbf{H}/X are locally ∞ -connected $(\Pi_X \dashv \Delta_X \dashv \Gamma_X) : \mathbf{H}/X \rightarrow \infty\text{Grpd}$.*

The two notions of fundamental ∞ -groupoids of any object X induced this way do agree, in that there is a natural equivalence

$$\Pi_X(X \in \mathbf{H}/X) \simeq \Pi(X \in \mathbf{H}).$$

Proof. By the general properties of over- ∞ -toposes ([L-Topos], prop 6.3.5.1) we have a a composite essential ∞ -geometric morphism

$$(\Pi_X \dashv \Delta_X \dashv \Gamma_X) : \mathbf{H}/X \begin{array}{c} \xrightarrow{X_!} \\ \xleftarrow{X^*} \\ \xrightarrow{X_*} \end{array} \mathbf{H} \begin{array}{c} \xrightarrow{\Pi} \\ \xleftarrow{\Delta} \\ \xrightarrow{\Gamma} \end{array} \infty\text{Grpd}$$

and $X_!$ is given by sending $(Y \rightarrow X) \in \mathbf{H}/X$ to $Y \in \mathbf{H}$. \square

3.8.2 Concordance

We formulate the notion of *concordance* (of bundles or cocycles) abstractly internal to a cohesive ∞ -topos.

Definition 3.8.7. For \mathbf{H} a cohesive ∞ -topos and $X, A \in \mathbf{H}$ two objects, we say that the ∞ -groupoid of *concordances* from X to A is

$$\text{Concord}(X, A) := \Pi[X, A],$$

where $[-, -] : \mathbf{H}^{\text{op}} \times \mathbf{H} \rightarrow \mathbf{H}$ is the internal hom.

Observation 3.8.8. For $X, A, B \in \mathbf{H}$ three objects, there is a canonical composition ∞ -functor of concordances between them

$$\text{Concord}(X, A) \times \text{Concord}(A, B) \rightarrow \text{Concord}(X, B).$$

Using that, by the axioms of cohesion, Π preserves products, this is the image under Π of the composition on internal homs

$$[X, A] \times [A, B] \rightarrow [X, B].$$

3.8.3 Paths and geometric Postnikov towers

The fundamental ∞ -groupoid ΠX of objects X in \mathbf{H} may be reflected back into \mathbf{H} , where it gives a notion of *geometric homotopy path n -groupoids* and a geometric notion of Postnikov towers of objects in \mathbf{H} .

Recall from def. 3.4.4 the pair of adjoint endofunctors

$$(\Pi \dashv b) : \mathbf{H} \rightarrow \mathbf{H}$$

on any locally connected ∞ -topos \mathbf{H} .

We say for any $X, A \in \mathbf{H}$

- $\Pi(X)$ is the *path ∞ -groupoid* of X – the reflection of the fundamental ∞ -groupoid from 3.8.1 back into the cohesive context of \mathbf{H} ;
- bA (“flat A ”) is the coefficient object for *flat differential A -cohomology* or for *A -local systems* (discussed below in 3.8.5).

Write

$$(\tau_n \dashv i_n) : \mathbf{H}_{\leq n} \xrightleftharpoons[i]{\tau_n} \mathbf{H}$$

for the reflective sub- ∞ -category of n -truncated objects ([L-Topos], section 5.5.6) and

$$\tau_n : \mathbf{H} \xrightarrow{\tau_n} \mathbf{H}_{\leq n} \hookrightarrow \mathbf{H}$$

for the localization functor. We say

$$\Pi_n : \mathbf{H} \xrightarrow{\Pi_n} \mathbf{H} \xrightarrow{\tau_n} \mathbf{H}$$

is the *homotopy path n -groupoid* functor. The (truncated) components of the $(\Pi \dashv \text{Disc})$ -unit

$$X \rightarrow \Pi_n(X)$$

we call the *constant path inclusion*. Dually we have canonical morphisms

$$bA \rightarrow A$$

natural in $A \in \mathbf{H}$.

Definition 3.8.9. For $X \in \mathbf{H}$ we say that the *geometric Postnikov tower* of X is the categorical Postnikov tower ([L-Topos] def. 5.5.6.23) of $\Pi(X) \in \mathbf{H}$:

$$\Pi(X) \rightarrow \cdots \rightarrow \Pi_2(X) \rightarrow \Pi_1(X) \rightarrow \Pi_0(X).$$

The main purpose of geometric Postnikov towers for us is the notion of *geometric Whitehead towers* that they induce, discussed in the next section.

3.8.4 Universal coverings and geometric Whitehead towers

We discuss an intrinsic notion of Whitehead towers in a locally ∞ -connected ∞ -topos \mathbf{H} .

Definition 3.8.10. For $X \in \mathbf{H}$ a pointed object, the *geometric Whitehead tower* of X is the sequence of objects

$$X^{(\infty)} \rightarrow \dots \rightarrow X^{(2)} \rightarrow X^{(1)} \rightarrow X^{(0)} \simeq X$$

in \mathbf{H} , where for each $n \in \mathbb{N}$ the object $X^{(n+1)}$ is the homotopy fiber of the canonical morphism $X \rightarrow \mathbf{\Pi}_{n+1}X$ to the path $(n+1)$ -groupoid of X (3.8.3). We call $X^{(n+1)}$ the $(n+1)$ -fold *universal covering space* of X . We write $X^{(\infty)}$ for the homotopy fiber of the untruncated constant path inclusion.

$$X^{(\infty)} \rightarrow X \rightarrow \mathbf{\Pi}(X).$$

Here the morphisms $X^{(n)} \rightarrow X^{(n-1)}$ are those induced from this pasting diagram of ∞ -pullbacks

$$\begin{array}{ccccc} X^{(n)} & \longrightarrow & * & & \\ \downarrow & & \downarrow & & \\ X^{(n-1)} & \longrightarrow & \mathbf{B}^n \pi_n(X) & \longrightarrow & * \\ \downarrow & & \downarrow & & \downarrow \\ X & \longrightarrow & \mathbf{\Pi}_n(X) & \xrightarrow{\tau_{\leq(n-1)}} & \mathbf{\Pi}_{(n-1)}(X) \end{array},$$

where the object $\mathbf{B}^n \pi_n(X)$ is defined as the homotopy fiber of the bottom right morphism.

Proposition 3.8.11. *Every object X in a cohesive ∞ -topos \mathbf{H} is covered by objects of the form $X^{(\infty)}$ for different choices of base points in X , in the sense that every X is the ∞ -colimit over a diagram whose vertices are of this form.*

Proof. Consider the diagram

$$\begin{array}{ccc} \lim_{\rightarrow s \in \mathbf{\Pi}(X)} (i^* *_s) & \longrightarrow & \lim_{\rightarrow s \in \mathbf{\Pi}(X)} *_s \\ \downarrow \simeq & & \downarrow \simeq \\ X & \xrightarrow{i} & \mathbf{\Pi}(X) \end{array}$$

The bottom morphism is the constant path inclusion, the $(\mathbf{\Pi} \dashv \text{Disc})$ -unit. The right morphism is the equivalence that is the image under Disc of the decomposition $\lim_{\rightarrow S} * \xrightarrow{\simeq} S$ of every ∞ -groupoid as the ∞ -colimit over itself of the ∞ -functor constant on the point. The left morphism is the ∞ -pullback along i of this equivalence, hence itself an equivalence. By universality of ∞ -colimits in the ∞ -topos \mathbf{H} , the top left object is the ∞ -colimit over the single homotopy fibers $i^* *_s$ of the form $X^{(\infty)}$ as indicated. \square

We would like claim that moreover each of the patches $i^* *_s$ of the object X in a cohesive ∞ -topos is geometrically contractible, thus exhibiting a generic cover of any object by contractibles. The following states something slightly weaker.

Proposition 3.8.12. *The inclusion $\mathbf{\Pi}(i^* *) \rightarrow \mathbf{\Pi}(X)$ of the fundamental ∞ -groupoid $\mathbf{\Pi}(i^* *)$ of each of these patches into $\mathbf{\Pi}(X)$ is homotopic to the point.*

Proof. We apply $\mathbf{\Pi}(-)$ to the above diagram over a single vertex s and attach the $(\mathbf{\Pi} \dashv \text{Disc})$ -counit to get

$$\begin{array}{ccccc} \mathbf{\Pi}(i^* *) & \longrightarrow & * & & \\ \downarrow & & \downarrow & & \\ \mathbf{\Pi}(X) & \xrightarrow{\mathbf{\Pi}(i)} & \mathbf{\Pi} \text{Disc } \mathbf{\Pi}(X) & \longrightarrow & \mathbf{\Pi}(X) \end{array}$$

Then the bottom morphism is an equivalence by the $(\mathbf{\Pi} \dashv \text{Disc})$ -zig-zag-identity. □
This implies that in a cohesive ∞ -topos every principal

3.8.5 Flat connections and local systems

We describe for a locally ∞ -connected ∞ -topos \mathbf{H} a canonical intrinsic notion of *flat connections on ∞ -bundles*, *flat higher parallel transport* and *∞ -local systems*.

Let $\mathbf{\Pi} : \mathbf{H} \rightarrow \mathbf{H}$ be the path ∞ -groupoid functor from def. 3.4.4, discussed in 3.8.3.

Definition 3.8.13. For $X, A \in \mathbf{H}$ we write

$$\mathbf{H}_{\text{flat}}(X, A) := \mathbf{H}(\mathbf{\Pi}X, A)$$

and call $H_{\text{flat}}(X, A) := \pi_0 \mathbf{H}_{\text{flat}}(X, A)$ the *flat (nonabelian) differential cohomology* of X with coefficients in A . We say a morphism $\nabla : \mathbf{\Pi}(X) \rightarrow A$ is a *flat ∞ -connection* on the principal ∞ -bundle corresponding to $X \rightarrow \mathbf{\Pi}(X) \xrightarrow{\nabla} A$, or an *A -local system* on X .

The induced morphism

$$\mathbf{H}_{\text{flat}}(X, A) \rightarrow \mathbf{H}(X, A)$$

we say is the forgetful functor that *forgets flat connections*.

The object $\mathbf{\Pi}(X)$ has the interpretation of the path ∞ -groupoid of X : it is a cohesive ∞ -groupoid whose k -morphisms may be thought of as generated from the k -morphisms in X and k -dimensional cohesive paths in X . Accordingly a morphism $\mathbf{\Pi}(X) \rightarrow A$ may be thought of as assigning

- to each point of X a fiber in A ;
- to each path in X an equivalence between these fibers;
- to each disk in X a 2-equivalence between these equivalences associated to its boundary
- and so on.

This we think of as encoding a flat *higher parallel transport* on X , coming from some flat ∞ -connection and *defining* this flat ∞ -connection.

Observation 3.8.14. By the $(\mathbf{\Pi} \dashv \flat)$ -adjunction we have a natural equivalence

$$\mathbf{H}_{\text{flat}}(X, A) \simeq \mathbf{H}(X, \flat A).$$

A cocycle $g : X \rightarrow A$ for a principal ∞ -bundle on X is in the image of

$$\mathbf{H}_{\text{flat}}(X, A) \rightarrow \mathbf{H}(X, A)$$

precisely if there is a lift ∇ in the diagram

$$\begin{array}{ccc} & & \flat A \\ & \nearrow \nabla & \downarrow \\ X & \xrightarrow{g} & A \end{array} .$$

We call $\flat A$ the *coefficient object for flat A -connections*.

Proposition 3.8.15. For $G := \text{Disc}(G_0) \in \mathbf{H}$ discrete ∞ -group (3.6.8) the canonical morphism $\mathbf{H}_{\text{flat}}(X, \mathbf{B}G) \rightarrow \mathbf{H}(X, \mathbf{B}G)$ is an equivalence.

Proof. This follows by definition 3.4.4 $\flat = \text{Disc} \Gamma$ and using that Disc is full and faithful. \square
This says that for discrete structure ∞ -groups G there is an essentially unique flat ∞ -connection on any G -principal ∞ -bundle. Moreover, the further equivalence

$$\mathbf{H}(\mathbf{\Pi}(X), \mathbf{B}G) \simeq \mathbf{H}_{\text{flat}}(X, \mathbf{B}G) \simeq \mathbf{H}(X, \mathbf{B}G)$$

may be read as saying that the G -principal ∞ -bundle for discrete G is entirely characterized by the flat higher parallel transport of this unique ∞ -connection.

Below in 3.8.6 we discuss in more detail the total spaces classified by ∞ -local systems.

3.8.6 Galois theory

We discuss a canonical internal realization of *locally constant ∞ -stacks* and their classification by *Galois theory* inside any cohesive ∞ -topos.

Classical Galois theory is the classification of certain extensions of a field K . Viewing the formal dual $\text{Spec}(K)$ as a space, this generalizes to *Galois theory of schemes*, which classifies κ -compact étale morphisms $E \rightarrow X$ over a connected scheme X by functors

$$\mathbf{\Pi}_1(X) \simeq \mathbf{B}\pi_1(X) \rightarrow \text{Set}_\kappa$$

from the classifying groupoid of the fundamental group of X (defined thereby) to the category of κ -small sets. See for instance [Len85] for an account.

From the point of view of topos theory over the étale site, κ -compact étale morphisms are equivalently sheaves (namely the sheaves of local sections of the étale morphism) that are locally constant on κ -small sets. The notion of locally constant sheaves of course exists over any site and in any topos whatsoever, and hence *topos theoretic Galois theory* more generally classifies locally constant sheaves. A general abstract category theoretic discussion of such generalized Galois theory is given by Janelidze, whose construction in the form of [CJKP97] we generalize below to locally connected ∞ -toposes.

A generalization of Galois theory from topos theory to ∞ -topos theory as a classification of *locally constant ∞ -stacks* was envisioned by Grothendieck and, for the special case over topological spaces, first formalized in [Toë00], where it is shown that the homotopy type of a connected locally contractible topological space X is the automorphism ∞ -group of the fiber functor on locally constant ∞ -stacks over X . Similar discussion appeared later in [PoWa05] and [Shu07].

We show below that this central statement of *higher Galois theory* holds generally in every ∞ -connected ∞ -topos.

For κ an uncountable regular cardinal, write

$$\text{Core } \infty\text{Grpd}_\kappa \in \infty\text{Grpd}$$

for the ∞ -groupoid of κ -small ∞ -groupoids, def. 4.2.19.

Definition 3.8.16. For $X \in \mathbf{H}$ write

$$\text{LConst}(X) := \mathbf{H}(X, \text{Disc}(\text{Core } \infty\text{Grpd}_\kappa))$$

for the cocycle ∞ -groupoid on X with coefficients in the discretely cohesive ∞ -groupoid on the ∞ -groupoid of κ -small ∞ -groupoids. We call this the ∞ -groupoid of *locally constant ∞ -stacks* on X .

Observation 3.8.17. Since Disc is left adjoint and right adjoint, it commutes with coproducts and with delooping, def. 3.6.113, so that by remark 4.2.20 we have

$$\text{Disc}(\text{Core } \infty\text{Grpd}_\kappa) \simeq \coprod_i \mathbf{B} \text{Disc}(\text{Aut}(F_i)).$$

Therefore, by the discussion in 3.6.10, a locally constant ∞ -stack $P \in \mathbf{LConst}(X)$ may be identified on each geometric connected component of X with the total space of a $\mathrm{Disc}\,\mathrm{Aut}(F_i)$ -principal ∞ -bundle $P \rightarrow X$.

Moreover, by the discussion in 3.6.13, to each such $\mathrm{Aut}(F_i)$ -principal ∞ -bundle is canonically associated a $\mathrm{Disc}(F_i)$ -fiber ∞ -bundle $E \rightarrow X$. This is the ∞ -pullback

$$\begin{array}{ccc} E & \longrightarrow & \mathrm{Disc}(F_i) // \mathrm{Disc}(\mathrm{Aut}(F_i)) \\ \downarrow & & \downarrow \\ X & \longrightarrow & \mathbf{B}\mathrm{Disc}(\mathrm{Aut}(F_i)) \end{array} .$$

Since by corollary 4.2.25 every discrete ∞ -bundle with κ -small fibers over connected X arises this way, essentially uniquely, we may canonically identify the morphism $E \rightarrow X$ with an object $E \in \mathbf{H}/_X$ in the little topos over X , which interprets as the ∞ -topos of ∞ -stacks over X , as discussed at the beginning of 3.6.15. This way the objects of $\mathbf{LConst}(X)$ are indeed identified with ∞ -stacks over X .

The following proposition says that the central statement of Galois theory holds for the notion of locally constant ∞ -stacks in a cohesive ∞ -topos.

Proposition 3.8.18. *For \mathbf{H} locally and globally ∞ -connected, we have*

1. a natural equivalence

$$\mathbf{LConst}(X) \simeq \infty\mathrm{Grpd}(\Pi(X), \infty\mathrm{Grpd}_\kappa)$$

of locally constant ∞ -stacks on X with ∞ -permutation representations of the fundamental ∞ -groupoid of X (local systems on X);

2. for every point $x : * \rightarrow X$ a natural equivalence of the endomorphisms of the fiber functor

$$x^* : \mathbf{LConst}(X) \rightarrow \infty\mathrm{Grpd}_\kappa$$

and the loop space of $\Pi(X)$ at x

$$\mathrm{End}(x^*) \simeq \Omega_x \Pi(X) .$$

Proof. The first statement is essentially the $(\Pi \dashv \mathrm{Disc})$ -adjunction :

$$\begin{aligned} \mathbf{LConst}(X) &:= \mathbf{H}(X, \mathrm{Disc}(\mathrm{Core}\,\infty\mathrm{Grpd}_\kappa)) \\ &\simeq \infty\mathrm{Grpd}(\Pi(X), \mathrm{Core}\,\infty\mathrm{Grpd}_\kappa) . \\ &\simeq \infty\mathrm{Grpd}(\Pi(X), \infty\mathrm{Grpd}_\kappa) \end{aligned}$$

Using this and that Π preserves the terminal object, so that the adjunct of $(* \rightarrow X \rightarrow \mathrm{Disc}\,\mathrm{Core}\,\infty\mathrm{Grpd}_\kappa)$ is $(* \rightarrow \Pi(X) \rightarrow \infty\mathrm{Grpd}_\kappa)$, the second statement follows with an iterated application of the ∞ -Yoneda lemma:

The fiber functor $x^* : \mathrm{Func}_\infty(\Pi(X), \infty\mathrm{Grpd}) \rightarrow \infty\mathrm{Grpd}$ evaluates an ∞ -presheaf on $\Pi(X)^{\mathrm{op}}$ at $x \in \Pi(X)$. By the ∞ -Yoneda lemma this is the same as homming out of $j(x)$, where $j : \Pi(X)^{\mathrm{op}} \rightarrow \mathrm{Func}(\Pi(X), \infty\mathrm{Grpd})$ is the ∞ -Yoneda embedding:

$$x^* \simeq \mathrm{Hom}_{\mathrm{PSh}(\Pi(X)^{\mathrm{op}})}(j(x), -) .$$

This means that x^* itself is a representable object in $\mathrm{PSh}_\infty(\mathrm{PSh}_\infty(\Pi(X)^{\mathrm{op}})^{\mathrm{op}})$. If we denote by $\tilde{j} : \mathrm{PSh}_\infty(\Pi(X)^{\mathrm{op}})^{\mathrm{op}} \rightarrow \mathrm{PSh}_\infty(\mathrm{PSh}_\infty(\Pi(X)^{\mathrm{op}})^{\mathrm{op}})$ the corresponding Yoneda embedding, then

$$x^* \simeq \tilde{j}(j(x)) .$$

With this, we compute the endomorphisms of x^* by applying the ∞ -Yoneda lemma two more times:

$$\begin{aligned} \mathrm{End}(x^*) &\simeq \mathrm{End}_{\mathrm{PSh}(\mathrm{PSh}(\Pi(X)^{\mathrm{op}})^{\mathrm{op}})}(\tilde{j}(j(x))) \\ &\simeq \mathrm{End}(\mathrm{PSh}(\Pi(X)^{\mathrm{op}})^{\mathrm{op}})(j(x)) \\ &\simeq \mathrm{End}_{\Pi(X)^{\mathrm{op}}}(x, x) \\ &\simeq \mathrm{Aut}_x \Pi(X) \\ &=: \Omega_x \Pi(X) \end{aligned} .$$

□

Next we discuss how this intrinsic Galois theory in a cohesive ∞ -topos is in line with the *categorical Galois theory* of Janelidze, as treated in [CJKP97]. This revolves around factorization systems associated with the path functor $\mathbf{\Pi}$ from 3.8.3.

Theorem 3.8.19. *If \mathbf{H} has an ∞ -cohesive site of definition, def. 3.4.17, the functor $\mathbf{\Pi} : \mathbf{H} \rightarrow \infty\text{Grpd}$ preserves ∞ -pullbacks over discrete objects.*

This was pointed out by Mike Shulman.

Proof. By prop. 5.2.5.1 in [L-Topos] the $(\mathbf{\Pi} \dashv \text{Disc})$ -adjunction passes for each $A \in \infty\text{Grpd}$ to the slice as

$$(\mathbf{\Pi}_{/\text{Disc}A} \dashv \text{Disc}_{/\text{Disc}A}) : \mathbf{H}_{/\text{Disc}A} \rightarrow \infty\text{Grpd}_{/A} .$$

Under the parameterized ∞ -Grothendieck construction, prop. 3.4.20, we have that $\mathbf{\Pi}_{/\text{Disc}A}$ becomes

$$\mathbf{\Pi}^A : \mathbf{H}^A \rightarrow \infty\text{Grpd}^A .$$

Since ∞ -limits of functor ∞ -categories are computed objectwise, and since $\mathbf{\Pi}$ preserves finite products by the axioms of cohesion, $\mathbf{\Pi}^A$ preserves finite products and hence so does $\mathbf{\Pi}_{/\text{Disc}A}$. Since a binary product in $\mathbf{H}_{/\text{Disc}A}$ is an ∞ -pullback over $\text{Disc}A$ in \mathbf{H} , this completes the proof. □

Remark 3.8.20. We find below that over some ∞ -cohesive sites of interest $\mathbf{\Pi}$ preserves further ∞ -pullbacks. See prop. 4.3.47.

Definition 3.8.21. For $f : X \rightarrow Y$ a morphism in \mathbf{H} , write

$$c_{\mathbf{\Pi}}f := Y \times_{\mathbf{\Pi}Y} \mathbf{\Pi}(X) \rightarrow Y$$

for the ∞ -pullback in

$$\begin{array}{ccc} c_{\mathbf{\Pi}}f & \longrightarrow & \mathbf{\Pi}X \\ \downarrow & & \downarrow \mathbf{\Pi}f \\ Y & \longrightarrow & \mathbf{\Pi}Y \end{array} ,$$

where the bottom morphism is the $(\mathbf{\Pi} \dashv \text{Disc})$ -unit. We say that $c_{\mathbf{\Pi}}f$ is the $\mathbf{\Pi}$ -closure of f , and that f is $\mathbf{\Pi}$ -closed if $X \simeq c_{\mathbf{\Pi}}f$.

Remark 3.8.22. In the discussion of *differential cohesion* below in 3.5 we see that the *infinitesimal* analog of $\mathbf{\Pi}$ -closeness is *formal étaleness*, see def. 3.10.19 below. There is a close conceptual relation: as we now discuss (prop. 3.8.30 below) morphisms $X \xrightarrow{f} Y$ that are $\mathbf{\Pi}$ -closed may be identified with the total space projections of *locally constant ∞ -stacks over Y* . Accordingly in a context of differential cohesion, $\mathbf{\Pi}_{\text{inf}}$ -closed such morphisms may be interpreted as projections out of total spaces of general ∞ -stacks over Y .

Definition 3.8.23. Call a morphism $f : X \rightarrow Y$ in \mathbf{H} a $\mathbf{\Pi}$ -equivalence if $\mathbf{\Pi}(f)$ is an equivalence in ∞Grpd .

Remark 3.8.24. Since $\text{Disc} : \infty\text{Grpd} \rightarrow \mathbf{H}$ is full and faithful, we may equivalently speak of $\mathbf{\Pi}$ -equivalences.

Proposition 3.8.25. *If \mathbf{H} has an ∞ -connected site of definition, then every morphism $f : X \rightarrow Y$ in \mathbf{H} factors as*

$$\begin{array}{ccc} X & \xrightarrow{f} & Y \\ & \searrow f' & \nearrow \\ & & c_{\mathbf{\Pi}}f \end{array} ,$$

where f' is a $\mathbf{\Pi}$ -equivalence.

Proof. The naturality of the adjunction unit together with the universality of the ∞ -pullback that defines $c_{\mathbf{\Pi}}f$ gives the factorization

$$\begin{array}{ccccc} X & \xrightarrow{f'} & Y \times_{\mathbf{\Pi}Y} \mathbf{\Pi}X & \longrightarrow & \mathbf{\Pi}X \\ & \searrow f & \downarrow & & \downarrow \mathbf{\Pi}f \\ & & Y & \longrightarrow & \mathbf{\Pi}Y \end{array} .$$

By theorem 3.8.19 the functor $\mathbf{\Pi}$ preserves the above ∞ -pullback. Since $\mathbf{\Pi}(X \rightarrow \mathbf{\Pi}X)$ is an equivalence, it follows that $\mathbf{\Pi}X$ is also a pullback of the $\mathbf{\Pi}$ -image of the diagram, and hence $\mathbf{\Pi}(f')$ is an equivalence. \square

Proposition 3.8.26. *For \mathbf{H} with an ∞ -cohesive site of definition, the pair of classes of morphisms*

$$(\mathbf{\Pi}\text{-equivalences, } \mathbf{\Pi}\text{-closed morphisms}) \subset \text{Mor}(\mathbf{H}) \times \text{Mor}(\mathbf{H})$$

constitutes an orthogonal factorization system (5.2.8 in [L-Topos]).

Proof. The factorization is given by prop. 3.8.25. It remains to check orthogonality. Let therefore

$$\begin{array}{ccc} A & \longrightarrow & X \\ \downarrow & & \downarrow \\ B & \longrightarrow & Y \end{array}$$

be any commuting diagram in \mathbf{H} , where the left morphism is a $\mathbf{\Pi}$ -equivalence and the right morphism is $\mathbf{\Pi}$ -closed. Then, by assumption, there exists a pullback diagram on the right in

$$\begin{array}{ccccc} A & \longrightarrow & X & \longrightarrow & \mathbf{\Pi}X \\ \downarrow & & \downarrow & & \downarrow \\ B & \longrightarrow & Y & \longrightarrow & \mathbf{\Pi}Y \end{array} .$$

By the naturality of the $(\mathbf{\Pi} \dashv \text{Disc})$ -unit, the outer rectangle above is equivalent to the outer rectangle of

$$\begin{array}{ccccc} A & \longrightarrow & \mathbf{\Pi}A & \longrightarrow & \mathbf{\Pi}X \\ \downarrow & & \downarrow \simeq & & \downarrow \\ B & \longrightarrow & \mathbf{\Pi}B & \longrightarrow & \mathbf{\Pi}Y \end{array} ,$$

where now, again by assumption, the middle vertical morphism is an equivalence. Therefore there exists an essentially unique lift in the right square of this diagram. This induces a lift in the outer rectangle. By the universality of the adjunction unit, such lifts factor essentially uniquely through $\mathbf{\Pi}B$ and hence this lift, too, is essentially unique. Finally by the universal property of the pullback $X \simeq c_{\mathbf{\Pi}}f$, this gives the required essentially unique lift on the left of

$$\begin{array}{ccccc} A & \longrightarrow & X & \longrightarrow & \mathbf{\Pi}X \\ \downarrow & \nearrow & \downarrow & & \downarrow \\ B & \longrightarrow & Y & \longrightarrow & \mathbf{\Pi}Y \end{array} .$$

\square

We now identify the $\mathbf{\Pi}$ -closed morphisms with covering spaces, hence with total spaces of locally constant ∞ -stacks.

Observation 3.8.27. For $f : X \rightarrow Y$ a $\mathbf{\Pi}$ -closed morphism, its fibers X_y over global points $y : * \rightarrow Y$ are discrete objects.

Proof. By assumption and using the pasting law, prop. 2.3.2, it follows that the fibers of f are the fibers of $\mathbf{\Pi}f$. Since the terminal object is discrete and since Disc preserves ∞ -pullbacks, these are the images under Disc of fibers of $\mathbf{\Pi}f$, and hence are discrete. \square
 Conversely we have:

Example 3.8.28. Let $X \in \mathbf{H}$ be any object, and let $A \in \infty\text{Grpd}$ be any discrete ∞ -groupoid. Then the projection morphism $p : X \times \text{Disc}(A) \rightarrow X$ out of the product is $\mathbf{\Pi}$ -closed.

Proof. Since $\mathbf{\Pi}$ preserves products, by the axioms of cohesion, and Disc preserves products as a right adjoint and is moreover full and faithful, we have that $\mathbf{\Pi}(p)$ is the projection

$$\mathbf{\Pi}(p) : \mathbf{\Pi}(X) \times \text{Disc}(A) \rightarrow \mathbf{\Pi}(X) .$$

Since ∞ -limits commute with ∞ -limits, it follows that

$$\begin{array}{ccc} X \times \text{Disc}(A) & \longrightarrow & \mathbf{\Pi}(X) \times \text{Disc}(A) \\ \downarrow & & \downarrow \\ X & \longrightarrow & \mathbf{\Pi}(X) \end{array}$$

is an ∞ -pullback. \square

Remark 3.8.29. Morphisms of the form $X \times \text{Disc}(A) \rightarrow X$ fit into pasting diagrams of ∞ -pullbacks of the form

$$\begin{array}{ccccc} X \times \text{Disc}(A) & \longrightarrow & \text{Disc}(A) & \longrightarrow & \text{Disc}(A//\text{Aut}(A)) \\ \downarrow & & \downarrow & & \downarrow \\ X & \longrightarrow & * & \longrightarrow & \mathbf{B}\text{Disc}(\text{Aut}(A)) \end{array} ,$$

where the square on the right is the universal discrete A -bundle, by the discussion in 3.6.13. According to def. 3.8.16 the composite morphism on the bottom classifies the *trivial* locally constant ∞ -stack with fiber A over X , hence the *constant* ∞ -stack with fiber A over X . Therefore the above ∞ -pullback exhibits $X \times \text{Disc}(A) \rightarrow X$ as the total space incarnation of that constant ∞ -stack on X .

The following proposition generalizes this statement to all locally constant ∞ -stacks over X .

Proposition 3.8.30. *Let \mathbf{H} have an ∞ -cohesive site of definition, 3.4.2.1. Then for any $X \in \mathbf{H}$ the locally constant ∞ -stacks $E \in \text{LConst}(X)$, regarded as ∞ -bundle morphisms $p : E \rightarrow X$ by observation 3.8.17, are precisely the $\mathbf{\Pi}$ -closed morphisms into X .*

Proof. We may without restriction of generality assume that X has a single geometric connected component. Then $E \rightarrow X$ is given by an ∞ -pullback of the form

$$\begin{array}{ccc} E & \longrightarrow & \text{Disc}(F_i//\text{Aut}(F_i)) . \\ \downarrow p & & \downarrow \\ X & \xrightarrow{g} & \mathbf{B}\text{DiscAut}(F_i) \end{array}$$

By theorem 3.8.19 the functor $\mathbf{\Pi}$ preserves this ∞ -pullback, so that also

$$\begin{array}{ccc} \mathbf{\Pi}E & \longrightarrow & \text{Disc}(F_i//\text{Aut}(F_i)) \\ \downarrow & & \downarrow \\ \mathbf{\Pi}X & \xrightarrow{\mathbf{\Pi}g} & \mathbf{B}\text{DiscAut}(F_i) \end{array}$$

is an ∞ -pullback, where we used that, by the axioms of cohesion, $\mathbf{\Pi}$ sends discrete objects to themselves.

By def. 3.8.21 the factorization in question is given by forming the ∞ -pullback on the left of

$$\begin{array}{ccccc} X \times_{\mathbf{\Pi}X} \mathbf{\Pi}E & \longrightarrow & \mathbf{\Pi}E & \longrightarrow & \text{Disc}(F_i // \text{Aut}(F_i)) \\ \downarrow & & \downarrow & & \downarrow \\ X & \longrightarrow & \mathbf{\Pi}X & \xrightarrow{\mathbf{\Pi}g} & \mathbf{B}\text{DiscAut}(F_i) \end{array} .$$

By the universal property of the $(\mathbf{\Pi} \dashv \text{Disc})$ -reflection, the bottom composite is again equivalent to g , hence by the pasting law, prop. 2.3.2, it follows that the pullback on the left is equivalent to $E \rightarrow X$.

Conversely, if the ∞ -pullback diagram on the left is given, it follows with prop. 4.2.23 and using, by definition of cohesion, that Disc is full and faithful, that an ∞ -pullback square as on the right exists. Again by the pasting law, this implies that the morphism on the left is the total space projection of a locally constant ∞ -stack over X . \square

Remark 3.8.31. In the “1-categorical Galois theory” of [CJKP97] only the trivial discrete ∞ -bundles arise as pullbacks this way, and much of the theory deals with getting around this restriction. In our language, this is because in the context of 1-categorical cohesion, as in [Law07], the ∞ -functor $\mathbf{\Pi}$ reduces to the 1-functor $\mathbf{\Pi}_0 \simeq \tau_0 \circ \mathbf{\Pi}$, discussed in 3.8.3, on a locally connected and connected 1-topos, which assigns only the set of connected components, instead of the full path ∞ -groupoid.

Clearly, the pullback over an object of the form $\mathbf{\Pi}_0 K$ is indeed a locally constant ∞ -stack that is trivial as a discretely fibered ∞ -bundle. But this restriction is lifted by passing from cohesive 1-toposes to cohesive ∞ -toposes.

We now characterize locally constant ∞ -stacks over X as precisely the “relatively discrete” objects over X . To that end, recall, by prop. 3.8.6, that for \mathbf{H} a locally ∞ -connected ∞ -topos also all the slice ∞ -toposes $\mathcal{X} := \mathbf{H}/_X$ for all objects $X \in \mathbf{H}$ are locally ∞ -connected.

Definition 3.8.32. For $X \in \mathbf{H}$ an object in a cohesive ∞ -topos \mathbf{H} and

$$\mathbf{H}/_X \begin{array}{c} \xrightarrow{p_!} \\ \xleftarrow{p^*} \\ \xrightarrow{p_*} \end{array} \infty\text{Grpd}$$

the corresponding locally ∞ -connected terminal geometric morphism, write

$$\mathbf{H}/_X \begin{array}{c} \xrightarrow{p_!/X} \\ \xleftarrow{p^*/X} \end{array} \infty\text{Grpd}/_{\mathbf{\Pi}(X)}$$

for the induced ∞ -adjunction on the slices, by prop. 5.2.5.1 in [L-Topos], where the left adjoint $p_!/X$ sends $(E \rightarrow X)$ to $(\mathbf{\Pi}(E) \rightarrow \mathbf{\Pi}(X))$.

Proposition 3.8.33. *Let the cohesive ∞ -topos H have an ∞ -cohesive site of definition, def. 3.4.17 and let $X \in \mathbf{H}$ be any object.*

The full sub- ∞ -category of $\mathbf{H}/_X$ on the $\mathbf{\Pi}$ -closed morphisms into X , def. 3.8.21, hence on the locally constant ∞ -stacks over X , prop. 3.8.30, is equivalent to the image of the morphism $p^/X : \infty\text{Grpd}/_{\mathbf{\Pi}(X)} \rightarrow \mathbf{H}/_X$.*

Proof. By prop 5.2.5.1 in [L-Topos], the ∞ -functor p^*/X is the composite

$$p^*/X : \infty\text{Grpd}/_{\mathbf{\Pi}(X)} \xrightarrow{\text{Disc}} \mathbf{H}/_{\mathbf{\Pi}} \xrightarrow{X \times_{\mathbf{\Pi}(X)} (-)} \mathbf{H}/_X .$$

This sends a morphism $Q \rightarrow \Pi(X)$ to the pullback on the left of the pullback square

$$\begin{array}{ccc} E & \longrightarrow & \text{Disc}(Q) \\ \downarrow & & \downarrow \\ X & \longrightarrow & \mathbf{\Pi}(X) \end{array} .$$

Since Π preserves this ∞ -pullback, by theorem 3.8.19, and sends $X \rightarrow \mathbf{\Pi}(X)$ to an equivalence, it follows that $\Pi(E \rightarrow X)$ is equivalent to $Q \rightarrow \Pi(X)$ and hence the above pullback diagram looks like

$$\begin{array}{ccc} E & \longrightarrow & \mathbf{\Pi}(E) \\ \downarrow & & \downarrow \\ X & \longrightarrow & \mathbf{\Pi}(X) \end{array} .$$

The naturality of the $(\Pi \dashv \text{Disc})$ -unit and the universality of the pullback imply that the top horizontal morphism here is indeed the E -component of the $(\Pi \dashv \text{Disc})$ unit.

This shows that, up to equivalence, precisely the $\mathbf{\Pi}$ -closed morphism $E \rightarrow X$ arise this way. \square

Remark 3.8.34. A definition of locally constant objects in general ∞ -toposes is given in section A.1 of [L-Alg]. The above prop. 3.8.33 together with theorem A.1.15 in [L-Topos] shows that restricted to the slices $\mathbf{H}/_X$ it coincides with the definition discussed here.

3.9 Structures in a cohesive ∞ -topos

We discuss differential geometric and differential cohomological structures that exist in any *cohesive ∞ -topos*, def. 3.4.1. These are obtained from the Π -geometric structures of a locally ∞ -connected ∞ -topos, discussed in 3.8 by interpreting them in the *gros* cohomological context of a local ∞ -topos, discussed in 3.7.

- 3.9.1 – \mathbb{A}^1 -Homotopy / The Continuum
- 3.9.2 – Manifolds
- 3.9.3 – de Rham cohomology
- 3.9.4 – Exponentiated Lie algebras
- 3.9.5 – Maurer-Cartan forms and curvature characteristic forms
- 3.9.6 – Differential cohomology
- 3.9.7 – Chern-Weil homomorphism
- 3.9.8 – Twisted differential structures
- 3.9.9 – Higher holonomy
- 3.9.10 – Transgression
- 3.9.11 – Chern-Simons functionals
- 3.9.12 – Wess-Zumino-Witten functionals
- 3.9.13 – Prequantum geometry
- 3.9.14 – Local prequantum field theory

3.9.1 \mathbb{A}^1 -Homotopy / The Continuum

We formalize in a cohesive ∞ -topos \mathbf{H} the notion of *the continuum* in the sense in which the standard real line \mathbb{R} is traditionally called *the continuum*. Abstractly this is an object $\mathbb{A}^1 \in \mathbf{H}$ which, when regarded as a *line object*, induces the geometric homotopy in \mathbf{H} as discussed in 3.8.1. Explicitly this means that $\Pi : \mathbf{H} \xrightarrow{\Pi} \infty\text{Grpd} \xleftarrow{\text{Disc}} \mathbf{H}$ exhibits the *localization* of \mathbf{H} which inverts all those morphisms that are products of an object with the terminal morphism $\mathbb{A}^1 \rightarrow *$. Since by cohesion $\Pi(*) \simeq *$, this means in particular that such an \mathbb{A}^1 is a geometrically contractible object in that $\Pi(\mathbb{A}^1) \simeq *$. Together this are the characterizing property of the archetypical “continuum” \mathbb{R} . Below in 3.9.2 we discuss how a continuum line object induces a notion of *manifold* objects in \mathbf{H} .

Remark 3.9.1. The ∞ -topos \mathbf{H} , being in particular a presentable ∞ -category, admits a choice of a small set $\{c_i \in \mathbf{H}\}_i$ of generating objects, and every small set of morphisms in \mathbf{H} induces a full reflective sub- ∞ -category of objects that are *local* with respect to these morphisms.

This is [L-Topos], section 5.

Definition 3.9.2. For \mathbf{H} a cohesive ∞ -topos, we say an object $I \in \mathbf{H}$ is a *continuum line object exhibiting the cohesion* of \mathbf{H} if the reflective inclusion of the discrete objects

$$(\Pi \dashv \text{Disc}) : \infty\text{Grpd} \xleftarrow[\text{Disc}]{\Pi} \mathbf{H}$$

is induced by the localization at the set of morphisms

$$S := \{c_i \times (I \rightarrow *)\}_i, ,$$

for $\{c_i\}_i$ some small set of generators of \mathbf{H} .

Remark 3.9.3. In this situation, for $X \in \mathbf{H}$ we may think of $\Pi(X)$ also as the *I-localization* of X .

A class of examples of this situation is the following.

Proposition 3.9.4. *Let C be an ∞ -cohesive site, def. 3.4.17, which moreover is the syntactic category of a Lawvere algebraic theory (see chapter 3, volume 2 of [Borc94]), in that it has finite products and there is an object*

$$\mathbb{A}^1 \in C$$

such that every other object is isomorphic to an n -fold cartesian product $\mathbb{A}^n = (\mathbb{A}^1)^n$.

Then $\mathbb{A}^1 \in C \hookrightarrow \text{Sh}_\infty(C)$ is a geometric interval exhibiting the cohesion of the ∞ -topos over C .

Proof. A set of generating objects of $\mathbf{H} = \text{Sh}_\infty(C)$ is given by the set of isomorphism classes of objects of C , hence, by assumption, by $\{\mathbb{A}^n\}_{n \in \mathbb{N}}$. The set of localizing morphisms is therefore

$$S := \{\mathbb{A}^{n+1} \rightarrow \mathbb{A}^n \mid n \in \mathbb{N}\}.$$

By prop. 3.4.18, \mathbf{H} is presented by the model category $[C^{\text{op}}, \text{sSet}]_{\text{proj,loc}}$. By the proof of [L-Topos] cor. A.3.7.10 the localization of \mathbf{H} as S is presented by the left Bousfield localization of this model category at S , given by a Quillen adjunction to be denoted

$$(L_{\mathbb{A}^1} \dashv R_{\mathbb{A}^1}) : [C^{\text{op}}, \text{sSet}]_{\text{proj,loc},\mathbb{A}^1} \xleftarrow[\text{id}]{\text{id}} [C^{\text{op}}, \text{sSet}]_{\text{proj,loc}} .$$

Observe that we also have a Quillen adjunction

$$(\text{const} \dashv (-)_*) : [C^{\text{op}}, \text{sSet}]_{\text{proj,loc},\mathbb{A}^1} \xleftarrow[(-)_*]{\text{const}} \text{sSet}_{\text{Quillen}} ,$$

where the right adjoint evaluates at the terminal object \mathbb{A}^0 , and where the left adjoint produces constant simplicial presheaves. This is because the two functors are clearly a Quillen adjunction before localization (on $[C^{\text{op}}, \text{sSet}]_{\text{proj}}$) and so by [L-Topos] cor. A.3.7.2 it is sufficient to observe that on the local structure the right adjoint still preserves fibrant objects, which it does because the fibrant objects in the localization are in particular fibrant in the unlocalized structure.

Moreover, we claim that $(\text{const } \dashv (-)_*)$ is in fact a Quillen equivalence, by observing that the derived adjunction unit and counit are equivalences. For the derived adjunction unit, notice that by the proof of prop. 3.4.18 a constant simplicial presheaf is fibrant in $[C^{\text{op}}, \text{sSet}]_{\text{proj,loc}}$, and so it is clearly fibrant in $[C^{\text{op}}, \text{sSet}]_{\text{proj,loc},\mathbb{A}^1}$. Therefore the plain adjunction unit, which is the identity, is already the derived adjunction unit. For the derived counit, let $X \in [C^{\text{op}}, \text{sSet}]_{\text{proj,loc},\mathbb{A}^1}$ be fibrant. Then also the adjunction counit

$$\eta : \text{const}(X(\mathbb{A}^0)) \rightarrow X$$

is already the derived counit (since $X(\mathbb{A}^1) \in \text{sSet}_{\text{Quillen}}$ is necessarily cofibrant). At every $\mathbb{A}^n \in C$ it is isomorphic to the sequence of morphisms

$$\eta(\mathbb{A}^n); X(\mathbb{A}^0) \rightarrow X(\mathbb{A}^1) \rightarrow \cdots \rightarrow X(\mathbb{A}^n),$$

each of which is a weak equivalence by the \mathbb{A}^1 -locality of X .

Now observe that we have an equivalence of ∞ -functors

$$\text{Disc} \simeq \mathbb{R}R_{\mathbb{A}^1} \circ \mathbb{L}\text{const} : \infty\text{Grpd} \rightarrow \mathbf{H}.$$

Because for $A \in \text{sSet}$ fibrant, $\mathbb{L}\text{const}(A) \simeq A$ is still fibrant, by the proof of prop. 3.4.18, and so $(\mathbb{R}R_{\mathbb{A}^1})(\mathbb{L}\text{const}(A)) \simeq \text{const}A$ is presented simply by the constant simplicial presheaf on A , which indeed is a presentation for $\text{Disc}A$, again by the proof of prop. 3.4.18.

Finally, since by the above $\mathbb{L}\text{const}$ is in fact an equivalence, by essential uniqueness of ∞ -adjoints it follows now that $\mathbb{L}L_{\mathbb{A}^1}$ is left adjoint to the ∞ -functor Disc , and this proves the claim. \square

Remark 3.9.5. Below in 4.3.5 we show that in the models of Euclidean-topological cohesion and of smooth cohesion the standard real line is indeed the continuum line object in the above abstract sense.

3.9.2 Manifolds (unseparated)

We discuss a general abstract realization of the notion of *unseparated manifolds* internal to a cohesive ∞ -topos. In order to formalize separated manifolds (Hausdorff manifolds) we need the extra axioms of differential cohesion. This is discussed below in 3.10.6.

Remark 3.9.6. The theory of principal ∞ -bundles in 3.6.10 extensively used two of the three Giraud-Rezk-Lurie axioms characterizing ∞ -toposes, def. 2.2.2 (universal coproducts and effective groupoid objects). Here we now use the third one, that *coproducts are disjoint*.

Proposition 3.9.7. *If $A \in \mathbf{H}$ is 0-truncated, def. 3.6.22 is geometrically connected in that $\Pi(A) \in \infty\text{Grpd}$ is connected, then morphisms $A \rightarrow X \coprod Y$ into a coproduct of 0-truncated objects in \mathbf{H} factor through one of the two inclusions $X \hookrightarrow X \coprod Y$ or $Y \hookrightarrow X \coprod Y$.*

Proof. The 1-topos $\tau_{\leq 0}\mathbf{H}$ of 0-truncated objects of a locally ∞ -connected ∞ -topos is a locally connected 1-topos by prop. 3.3.3. Under this identification, $A \in \tau_0\mathbf{H}$ as above is a connected object, and hence is in particular not a coproduct of two non-initial objects. Since moreover coproducts in \mathbf{H} and in $\tau_{\leq 0}\mathbf{H}$ are disjoint and since truncation (being a left adjoint) preserves them, the statement reduces to a standard fact in topos theory (for instance [Joh02], p. 34). \square

Let now $\mathbb{A}^1 \in \mathbf{H}$ be a continuum line object that *exhibits the cohesion of \mathbf{H}* in the sense of def. 3.9.2. For $n \in \mathbb{N}$, write

$$\mathbb{A}^n := \underbrace{\mathbb{A}^1 \times \cdots \times \mathbb{A}^1}_{n \text{ factors}}.$$

Proposition 3.9.8. *For all $n \in \mathbb{N}$ the objects $\mathbb{A}^n \in \mathbf{H}$ are geometrically connected.*

Proof. By cohesion, $\Pi : \mathbf{H} \rightarrow \infty\text{Grpd}$ preserves finite products and so the statement reduces to the fact that the product of two connected ∞ -groupoids is itself a connected ∞ -groupoid. \square

Definition 3.9.9. Given an object $\mathbb{A}^1 \in \mathbf{H}$ exhibiting the cohesion of the cohesive topos \mathbf{H} , an object $X \in \mathbf{H}$ is an *unseparated \mathbb{A} -manifold of dimension $n \in \mathbb{N}$* if there exists a small set of monomorphisms of the form

$$\{\mathbb{A}^n \xrightarrow{\phi_j} X\}_j$$

such that for the corresponding

$$\phi : \coprod_j \mathbb{A}^n \xrightarrow{(\phi_j)_j} X$$

we have

1. ϕ is an effective epimorphism, def. 2.3.3;
2. the nerve simplicial object $C_\bullet(\phi)$ of ϕ is degreewise a coproduct of copies of \mathbb{A}^n .

Remark 3.9.10. Since monomorphisms are stable under pullback and since by the Giraud-Rezk-Lurie axioms coproducts are preserved under pullback, it follows that the simplicial object in def. 3.9.9 is such that all components $\mathbb{A}^n \rightarrow \mathbb{A}^n$ of all face maps (given by prop. 3.9.7 and prop. 3.9.8) are monomorphisms.

Remark 3.9.11. Below in 4.3.6 and 4.4.11 is discussed that in the standard model of Euclidean-topological and of smooth cohesion this abstract definition reproduces the traditional definition of topological and of smooth manifolds, respectively.

3.9.3 de Rham cohomology

We discuss how in every locally ∞ -connected ∞ -topos \mathbf{H} there is an intrinsic notion of *nonabelian de Rham cohomology*.

We have already seen the notions of *Principal bundles*, 3.6.10, and of flat ∞ -connections on principal ∞ -bundles, 3.8.5, in any locally ∞ -connected ∞ -topos. In traditional differential geometry, flat connection on the *trivial* principal bundle may be canonically identified with flat differential 1-forms on the base space. In the following we take this idea to be the *definition* of flat ∞ -group/ ∞ -Lie algebra valued forms: flat ∞ -connections on trivial principal ∞ -bundles.

Definition 3.9.12. Let \mathbf{H} be a locally ∞ -connected ∞ -topos. For $X \in \mathbf{H}$ an object, write $\mathbf{\Pi}_{\text{dR}}X := * \amalg_X \mathbf{\Pi}X$ for the ∞ -pushout

$$\begin{array}{ccc} X & \longrightarrow & * \\ \downarrow & & \downarrow \\ \mathbf{\Pi}(X) & \longrightarrow & \mathbf{\Pi}_{\text{dR}}X \end{array} .$$

We call this the *cohesive de Rham homotopy type* of X (see remark 3.9.19 below).

For $\text{pt}_A : * \rightarrow A$ any pointed object in \mathbf{H} , write $b_{\text{dR}}A := * \prod_A bA$ for the ∞ -pullback

$$\begin{array}{ccc} b_{\text{dR}}A & \longrightarrow & bA \\ \downarrow & & \downarrow \\ * & \longrightarrow & A \end{array} .$$

We call this the *de Rham coefficient object* of $\text{pt}_A : * \rightarrow A$.

Proposition 3.9.13. *This construction yields a pair of adjoint ∞ -functors*

$$(\Pi_{\text{dR}} \dashv b_{\text{dR}}) : * / \mathbf{H} \begin{array}{c} \xleftarrow{\Pi_{\text{dR}}} \\ \xrightarrow{b_{\text{dR}}} \end{array} \mathbf{H} .$$

Proof. We check the defining natural hom-equivalence

$$* / \mathbf{H}(\Pi_{\text{dR}}X, A) \simeq \mathbf{H}(X, b_{\text{dR}}A) .$$

The hom-space in the under- ∞ -category $* / \mathbf{H}$ is computed by prop. 3.6.5 as the ∞ -pullback

$$\begin{array}{ccc} * / \mathbf{H}(\Pi_{\text{dR}}X, A) & \longrightarrow & \mathbf{H}(\Pi_{\text{dR}}X, A) \\ \downarrow & & \downarrow \\ * & \xrightarrow{\text{pt}_A} & \mathbf{H}(*, A) \end{array} .$$

By the fact that the hom-functor $\mathbf{H}(-, -) : \mathbf{H}^{\text{op}} \times \mathbf{H} \rightarrow \infty\text{Grpd}$ preserves ∞ -limits in both arguments we have a natural equivalence

$$\begin{aligned} \mathbf{H}(\Pi_{\text{dR}}X, A) &:= \mathbf{H}(* \prod_X \Pi(X), A) \\ &\simeq \mathbf{H}(*, A) \prod_{\mathbf{H}(X, A)} \mathbf{H}(\Pi(X), A) . \end{aligned}$$

We paste this pullback to the above pullback diagram to obtain

$$\begin{array}{ccccc} * / \mathbf{H}(\Pi_{\text{dR}}X, A) & \longrightarrow & \mathbf{H}(\Pi_{\text{dR}}X, A) & \longrightarrow & \mathbf{H}(\Pi(X), A) \\ \downarrow & & \downarrow & & \downarrow \\ * & \xrightarrow{\text{pt}_A} & \mathbf{H}(*, A) & \longrightarrow & \mathbf{H}(X, A) \end{array} .$$

By the pasting law for ∞ -pullbacks, prop. 2.3.2, the outer diagram is still a pullback. We may evidently rewrite the bottom composite as in

$$\begin{array}{ccc} * / \mathbf{H}(\Pi_{\text{dR}}X, A) & \longrightarrow & \mathbf{H}(\Pi(X), A) \\ \downarrow & & \downarrow \\ * & \xrightarrow{\simeq} & \mathbf{H}(X, *) \xrightarrow{(\text{pt}_A)^*} \mathbf{H}(X, A) \end{array} .$$

This exhibits the hom-space as the pullback

$$* / \mathbf{H}(\Pi_{\text{dR}}(X), A) \simeq \mathbf{H}(X, *) \prod_{\mathbf{H}(X, A)} \mathbf{H}(X, bA) ,$$

where we used the $(\mathbf{\Pi} \dashv b)$ -adjunction. Now using again that $\mathbf{H}(X, -)$ preserves pullbacks, this is

$$\dots \simeq \mathbf{H}(X, * \coprod_A bA) \simeq \mathbf{H}(X, b_{\text{dR}}A).$$

□

Observation 3.9.14. If \mathbf{H} is also local, then there is a further right adjoint $\mathbf{\Gamma}_{\text{dR}}$

$$(\mathbf{\Pi}_{\text{dR}} \dashv b_{\text{dR}} \dashv \mathbf{\Gamma}_{\text{dR}}) : \mathbf{H} \begin{array}{c} \xleftarrow{-\mathbf{\Pi}_{\text{dR}}} \\ \xrightarrow{\mathbf{\Gamma}_{\text{dR}}} \\ \xrightarrow{b_{\text{dR}}} \end{array} */\mathbf{H}$$

given by

$$\mathbf{\Gamma}_{\text{dR}}X := * \coprod_X \mathbf{\Gamma}(X).$$

Definition 3.9.15. For $X, A \in \mathbf{H}$ we write

$$\mathbf{H}_{\text{dR}}(X, A) := \mathbf{H}(\mathbf{\Pi}_{\text{dR}}X, A) \simeq \mathbf{H}(X, b_{\text{dR}}A).$$

A cocycle $\omega : X \rightarrow b_{\text{dR}}A$ we call a *flat A -valued differential form* on X .

We say that $H_{\text{dR}}(X, A) := \pi_0 \mathbf{H}_{\text{dR}}(X, A)$ is the *de Rham cohomology* of X with coefficients in A .

Observation 3.9.16. A cocycle in de Rham cohomology

$$\omega : \mathbf{\Pi}_{\text{dR}}X \rightarrow A$$

is precisely a flat ∞ -connection on a *trivializable* A -principal ∞ -bundle. More precisely, $\mathbf{H}_{\text{dR}}(X, A)$ is the homotopy fiber of the forgetful functor from ∞ -bundles with flat ∞ -connection to ∞ -bundles: we have an ∞ -pullback diagram

$$\begin{array}{ccc} \mathbf{H}_{\text{dR}}(X, A) & \longrightarrow & * \\ \downarrow & & \downarrow \\ \mathbf{H}_{\text{flat}}(X, A) & \longrightarrow & \mathbf{H}(X, A) \end{array} .$$

Proof. This follows by the fact that the hom-functor $\mathbf{H}(X, -)$ preserves the defining ∞ -pullback for $b_{\text{dR}}A$. □

Just for emphasis, notice the dual description of this situation: by the universal property of the ∞ -colimit that defines $\mathbf{\Pi}_{\text{dR}}X$ we have that ω corresponds to a diagram

$$\begin{array}{ccc} X & \longrightarrow & * \\ \downarrow & & \downarrow \\ \mathbf{\Pi}(X) & \xrightarrow{\omega} & A \end{array} .$$

The bottom horizontal morphism is a flat connection on the ∞ -bundle which in turn is given by the composite cocycle $X \rightarrow \mathbf{\Pi}(X) \xrightarrow{\omega} A$. The diagram says that this is equivalent to the trivial bundle given by the trivial cocycle $X \rightarrow * \rightarrow A$.

Proposition 3.9.17. *The de Rham cohomology with coefficients in discrete objects is trivial: for all $S \in \infty\text{Grpd}$ we have*

$$b_{\text{dR}}\text{Disc}S \simeq *.$$

Proof. Using that in a ∞ -connected ∞ -topos the functor Disc is a full and faithful ∞ -functor so that unit $\text{Id} \rightarrow \Gamma \text{Disc}$ is an equivalence and using that by the zig-zag identity the counit component $\flat \text{Disc} S := \text{Disc} \Gamma \text{Disc} S \rightarrow \text{Disc} S$ is also an equivalence, we have

$$\begin{aligned} \flat_{\text{dR}} \text{Disc} S &:= * \prod_{\text{Disc} S} \flat \text{Disc} S \\ &\simeq * \prod_{\text{Disc} S} \text{Disc} S , \\ &\simeq * \end{aligned}$$

since the pullback of an equivalence is an equivalence. \square

Proposition 3.9.18. *For every X in a cohesive ∞ -topos \mathbf{H} , the object $\mathbf{\Pi}_{\text{dR}} X$ is globally connected in that $\pi_0 \mathbf{H}(*, \mathbf{\Pi}_{\text{dR}} X) = *$.*

*If X has at least one point ($\pi_0(\Gamma X) \neq \emptyset$) and is geometrically connected ($\pi_0(\Pi X) = *$) then $\mathbf{\Pi}_{\text{dR}}(X)$ is also locally connected: $\tau_0 \mathbf{\Pi}_{\text{dR}} \simeq * \in \mathbf{H}$.*

Proof. Since Γ preserves ∞ -colimits in a cohesive ∞ -topos we have

$$\begin{aligned} \mathbf{H}(*, \mathbf{\Pi}_{\text{dR}} X) &\simeq \Gamma \mathbf{\Pi}_{\text{dR}} X \\ &\simeq * \prod_{\Gamma X} \Gamma \Pi X , \\ &\simeq * \prod_{\Gamma X} \Pi X \end{aligned}$$

where in the last step we used that Disc is full and faithful, so that there is an equivalence $\Gamma \Pi X := \Gamma \text{Disc} \Pi X \simeq \Pi X$.

To analyse this ∞ -pushout we present it by a homotopy pushout in $\text{sSet}_{\text{Quillen}}$. Denoting by ΓX and ΠX any representatives in $\text{sSet}_{\text{Quillen}}$ of the objects of the same name in ∞Grpd , this may be computed by the ordinary pushout of simplicial sets

$$\begin{array}{ccc} \Gamma X & \longrightarrow & (\Gamma X) \times \Delta[1] \amalg_{\Gamma X} * , \\ \downarrow & & \downarrow \\ \Pi X & \longrightarrow & Q \end{array}$$

where on the right we have inserted the cone on ΓX in order to turn the top morphism into a cofibration. From this ordinary pushout it is clear that the connected components of Q are obtained from those of ΠX by identifying all those in the image of a connected component of ΓX . So if the left morphism is surjective on π_0 then $\pi_0(Q) = *$. This is precisely the condition that *pieces have points* in \mathbf{H} .

For the local analysis we consider the same setup objectwise in the injective model structure $[C^{\text{op}}, \text{sSet}]_{\text{inj,loc}}$. For any $U \in C$ we then have the pushout Q_U in

$$\begin{array}{ccc} X(U) & \longrightarrow & (X(U)) \times \Delta[1] \amalg_{X(U)} * , \\ \downarrow & & \downarrow \\ \text{sSet}(\Gamma(U), \Pi X) & \longrightarrow & Q_U \end{array}$$

as a model for the value of the simplicial presheaf presenting $\mathbf{\Pi}_{\text{dR}}(X)$. If X is geometrically connected then $\pi_0 \text{sSet}(\Gamma(U), \Pi(X)) = *$ and hence for the left morphism to be surjective on π_0 it suffices that the top left object is not empty. Since the simplicial set $X(U)$ contains at least the vertices $U \rightarrow * \rightarrow X$ of which there is by assumption at least one, this is the case. \square

Remark 3.9.19. In summary we see that in any cohesive ∞ -topos the objects $\mathbf{\Pi}_{\mathrm{dR}}(X)$ of def. 3.9.12 have the essential abstract properties of pointed *geometric de Rham homotopy types* ([Toë06], section 3.5.1). In section 4 we will see that, indeed, the intrinsic de Rham cohomology of the cohesive ∞ -topos $\mathbf{H} = \mathrm{Smooth}\infty\mathrm{Grpd}$

$$H_{\mathrm{dR}}(X, A) := \pi_0 \mathbf{H}(\mathbf{\Pi}_{\mathrm{dR}} X, A)$$

reproduces ordinary de Rham cohomology in degree $d > 1$.

In degree 0 the intrinsic de Rham cohomology is necessarily trivial, while in degree 1 we find that it reproduces closed 1-forms, not divided out by exact forms. This difference to ordinary de Rham cohomology in the lowest two degrees may be understood in terms of the obstruction-theoretic meaning of de Rham cohomology by which we essentially characterized it above: we have that the intrinsic $H_{\mathrm{dR}}^n(X, K)$ is the home for the obstructions to flatness of $\mathbf{B}^{n-2}K$ -principal ∞ -bundles. For $n = 1$ this are groupoid-principal bundles over the *groupoid* with K as its space of objects. But the 1-form curvatures of groupoid bundles are not to be regarded modulo exact forms.

We turn now to identifying certain de Rham cocycles that are adapted to intrinsic manifolds, as discussed in 3.9.2. In general a cocycle $\omega : X \rightarrow \mathfrak{b}_{\mathrm{dR}}\mathbf{B}A$ is to be thought of as what traditionally is called a cocycle in de Rham *hypercohomology*. The following definition models the idea of picking in de Rham hypercohomology over a manifold those cycles that are given by globally defined differential forms.

Fix a line object $\mathbb{A}^1 \in \mathbf{H}$ which *exhibits the cohesion* of \mathbf{H} in the sense of def. 3.9.2.

Definition 3.9.20. For $A \in \mathrm{Grp}(\mathbf{H})$ an ∞ -group, a choice of *A-valued differential forms* is a morphism

$$\Omega_{\mathrm{cl}}(-, A) \rightarrow \mathfrak{b}_{\mathrm{dR}}\mathbf{B}A$$

in \mathbf{H} , which is an *atlas over manifolds* of $\mathfrak{b}_{\mathrm{dR}}\mathbf{B}A$, in that:

1. $\Omega_{\mathrm{cl}}(-, A)$ is 0-truncated;
2. for each intrinsic \mathbb{A}^1 -manifold Σ , def. 3.9.9, the morphism $[\Sigma, \Omega_{\mathrm{cl}}^n(-, A)] \rightarrow [\Sigma, \mathfrak{b}_{\mathrm{dR}}\mathbf{B}^n A]$ is an effective epimorphism, def. 2.3.3.

Remark 3.9.21. We discuss below in 4.4.53 how in the standard model of smooth cohesion this notion reproduces the traditional notion of smooth differential forms.

3.9.4 Exponentiated ∞ -Lie algebras

We consider an intrinsic notion of *exponentiated* ∞ -Lie algebras in every cohesive ∞ -topos. In order to have a general abstract notion of the ∞ -Lie algebras themselves we need the further axiomatics of *infinitesimal cohesion*, discussed below in 3.5 and 3.10.9.

Definition 3.9.22. For a connected object $\mathbf{B} \exp(\mathfrak{g})$ in \mathbf{H} that is *geometrically contractible*

$$\Pi(\mathbf{B} \exp(\mathfrak{g})) \simeq *$$

we call its loop space object (see 3.6.8) $\exp(\mathfrak{g}) := \Omega_* \mathbf{B} \exp(\mathfrak{g})$ a *Lie integrated ∞ -Lie algebra* in \mathbf{H} .

Definition 3.9.23. Set

$$\exp \mathrm{Lie} := \mathbf{\Pi}_{\mathrm{dR}} \circ \mathfrak{b}_{\mathrm{dR}} : */\mathbf{H} \rightarrow */\mathbf{H}.$$

Observation 3.9.24. If \mathbf{H} is cohesive, then $\exp \mathrm{Lie}$ is a left adjoint.

Proof. By the construction in def. 3.4.4. □

Example 3.9.25. For all $X \in \mathbf{H}$ the object $\mathbf{\Pi}_{\mathrm{dR}}(X)$ is geometrically contractible.

Proof. Since on the locally ∞ -connected and ∞ -connected \mathbf{H} the functor Π preserves ∞ -colimits and the terminal object, we have

$$\begin{aligned} \Pi\Pi_{\mathrm{dR}}X &:= \Pi(*) \coprod_{\Pi X} \Pi\Pi X \\ &\simeq * \coprod_{\Pi X} \Pi\mathrm{Disc}\Pi X \quad , \\ &\simeq * \coprod_{\Pi X} \Pi X \quad \simeq * \end{aligned}$$

where we used that on the ∞ -connected \mathbf{H} the functor Disc is full and faithful. \square

Corollary 3.9.26. *We have for every $(* \rightarrow A) \in */\mathbf{H}$ that $\exp\mathrm{Lie}A$ is geometrically contractible.*

We shall write $\mathbf{B}\exp(\mathfrak{g})$ for $\exp\mathrm{Lie}\mathbf{B}G$, when the context is clear.

Proposition 3.9.27. *Every de Rham cocycle (3.9.3) $\omega : \Pi_{\mathrm{dR}}X \rightarrow \mathbf{B}G$ factors through the Lie integrated ∞ -Lie algebra of G*

$$\begin{array}{ccc} & \mathbf{B}\exp(\mathfrak{g}) & . \\ & \nearrow & \downarrow \\ \Pi_{\mathrm{dR}}X & \xrightarrow{\omega} & \mathbf{B}G \end{array}$$

Proof. By the universality of the $(\Pi_{\mathrm{dR}} \dashv \flat_{\mathrm{dR}})$ -counit we have that ω factors through the counit $\epsilon : \exp\mathrm{Lie}\mathbf{B}G \rightarrow \mathbf{B}G$

$$\begin{array}{ccc} & \Pi_{\mathrm{dR}}X & , \\ \Pi_{\mathrm{dR}}\tilde{\omega} \swarrow & & \searrow \omega \\ \Pi_{\mathrm{dR}}\flat_{\mathrm{dR}}\mathbf{B}G & \xrightarrow{\epsilon} & \mathbf{B}G \end{array}$$

where $\tilde{\omega} : X \rightarrow \flat_{\mathrm{dR}}\mathbf{B}G$ is the adjunct of ω . \square

Therefore instead of speaking of a G -valued de Rham cocycle, it is less redundant to speak of an $\exp(\mathfrak{g})$ -valued de Rham cocycle. In particular we have the following.

Corollary 3.9.28. *Every morphism $\mathbf{B}\exp(\mathfrak{h}) := \exp\mathrm{Lie}\mathbf{B}H \rightarrow \mathbf{B}G$ from a Lie integrated ∞ -Lie algebra to an ∞ -group factors through the Lie integrated ∞ -Lie algebra of that ∞ -group*

$$\begin{array}{ccc} \mathbf{B}\exp(\mathfrak{h}) & \longrightarrow & \mathbf{B}\exp(\mathfrak{g}) \quad . \\ & \searrow & \downarrow \\ & & \mathbf{B}G \end{array}$$

3.9.5 Maurer-Cartan forms and curvature characteristic forms

In the intrinsic de Rham cohomology of the cohesive ∞ -topos \mathbf{H} there exist canonical cocycles that we may identify with *Maurer-Cartan forms* and with universal *curvature characteristic forms*.

Definition 3.9.29. For $G \in \mathrm{Group}(\mathbf{H})$ an ∞ -group in the cohesive ∞ -topos \mathbf{H} , write

$$\theta : G \rightarrow \flat_{\mathrm{dR}}\mathbf{B}G$$

for the G -valued de Rham cocycle on G induced by this pasting of ∞ -pullbacks

$$\begin{array}{ccc}
 G & \longrightarrow & * \\
 \theta \downarrow & & \downarrow \\
 \mathfrak{b}_{\mathrm{dR}}\mathbf{B}G & \longrightarrow & \mathfrak{b}\mathbf{B}G \\
 \downarrow & & \downarrow \\
 * & \longrightarrow & \mathbf{B}G
 \end{array}$$

using prop. 3.9.27.

We call θ the *Maurer-Cartan form* on G .

Remark 3.9.30. For any object X , postcomposition the Maurer-Cartan form sends G -valued functions on X to \mathfrak{g} -valued forms on X

$$[\theta_*] : H^0(X, G) \rightarrow H_{\mathrm{dR}}^1(X, G).$$

Remark 3.9.31. For $G = \mathbf{B}^n A$ an Eilenberg-MacLane object, we also write

$$\mathrm{curv} : \mathbf{B}^n A \rightarrow \mathfrak{b}_{\mathrm{dR}}\mathbf{B}^{n+1} A$$

for its intrinsic Maurer-Cartan form and call this the intrinsic *universal curvature characteristic form* on $\mathbf{B}^n A$.

These curvature characteristic forms serve to define differential cohomology in the next section.

3.9.6 Differential cohomology

We discuss an intrinsic realization of *differential cohomology* (see for instance [Bun12]) with coefficients in braided ∞ -groups in any cohesive ∞ -topos.

We first give a general discussion in 3.9.6.1 and then consider a special class of cases in 3.9.6.2. Finally we discuss issues of constructing differential moduli objects in 3.9.6.4.

In the case that the homotopy type is not just braided, hence twice deloopable, but is in fact stable (a spectrum object), then there is a strengthening of the theory of differential cohomology to differential stable cohomology, which enjoys very good properties. This we come to below in the discussion of the models of Goodwillie-tangent cohesion 4.1.2.

Notice that for many of the applications in 5 it is crucial to have available also generally the non-stable differential cohomology discussed here. This is necessary specifically for the discussion of Wess-Zumino-Witten-type prequantum field theory in 5.6.

3.9.6.1 General

Definition 3.9.32. For \mathbb{G} a braided ∞ -group, def. 3.6.116, write

$$\mathrm{curv}_{\mathbb{G}} := \theta_{\mathbf{B}\mathbb{G}} : \mathbf{B}\mathbb{G} \rightarrow \mathfrak{b}_{\mathrm{dR}}\mathbf{B}^2\mathbb{G}$$

for the Maurer-Cartan form, def. 3.9.29, on its delooping ∞ -group $\mathbf{B}\mathbb{G}$. We call this the *universal curvature characteristic* of \mathbb{G} .

We say that the cohomology in the slice ∞ -topos $\mathbf{H}/_{\mathfrak{b}_{\mathrm{dR}}\mathbf{B}^2\mathbb{G}}$ with coefficients in $\mathrm{curv}_{\mathbb{G}}$ is the *differential cohomology* with coefficients in $\mathbf{B}\mathbb{G}$.

Remark 3.9.33. A domain object $(X, F) \in \mathbf{H}/_{\mathfrak{b}_{\mathrm{dR}}\mathbf{B}^2\mathbb{G}}$ is an object $X \in \mathbf{H}$ equipped with a de Rham cocycle $F : X \rightarrow \mathfrak{b}_{\mathrm{dR}}\mathbf{B}^2\mathbb{G}$, to be thought of as a prescribed *curvature differential form*.

A differential cocycle $\nabla \in \mathbf{H}/\flat_{\mathrm{dR}}\mathbf{B}^2\mathbb{G}((X, F), \mathrm{curv}_{\mathbb{G}})$ on such a pair is a diagram of the form

$$\begin{array}{ccc} X & \xrightarrow{g} & \mathbf{B}\mathbb{G} \\ & \searrow F & \swarrow \mathrm{curv}_{\mathbb{G}} \\ & & \flat_{\mathrm{dR}}\mathbf{B}^2\mathbb{G} \end{array}$$

∇ (represented by a double arrow from X to $\flat_{\mathrm{dR}}\mathbf{B}^2\mathbb{G}$)

in \mathbf{H} . This is

1. a cocycle $g : X \rightarrow \mathbf{B}\mathbb{G}$ in \mathbf{H} for a \mathbb{G} -principal ∞ -bundle over X ;
2. a choice of equivalence

$$g^* \mathrm{curv}_{\mathbb{G}} \xrightarrow[\simeq]{\nabla} F$$

between the pullback of the universal \mathbb{G} -curvature characteristic, def. 3.9.32 and the prescribed curvature differential form.

This choice of equivalence is to be interpreted as a *connection* on the \mathbb{G} -principal bundle modulated by g .

Often one is of interested in demanding that the curvature $F : X \rightarrow \flat_{\mathrm{dR}}\mathbf{B}^2\mathbb{G}$ in the above factors through a prescribed morphism $C \rightarrow \flat_{\mathrm{dR}}\mathbf{B}^2\mathbb{G}$, notably through an inclusion of differential forms as in def. 3.9.20. This means that one is interested in cocycles as in remark 3.9.33 above which factor as diagrams

$$\begin{array}{ccc} X & \xrightarrow{g} & \mathbf{B}\mathbb{G} \\ \downarrow F & \swarrow \nabla & \swarrow \mathrm{curv}_{\mathbb{G}} \\ C & \longrightarrow & \flat_{\mathrm{dR}}\mathbf{B}^2\mathbb{G} \end{array}$$

This in turn means equivalently that the cocycle is given by a morphism $\nabla : X \rightarrow \mathbf{B}\mathbb{G}_{\mathrm{conn}}$ into the ∞ -pullback $\mathbf{B}\mathbb{G}_{\mathrm{conn}} \simeq C \times_{\flat_{\mathrm{dR}}\mathbf{B}^2\mathbb{G}} \mathbf{B}\mathbb{G}$. This object we may then regard as a *moduli stack for differential cohomology* with coefficients in A and curvatures in C .

This we now discuss in 3.9.6.2 below.

3.9.6.2 Global curvature forms We consider the subcase of the general notion of differential cohomology as in 3.9.6.1 above, where now the curvatures are required to be globally defined differential forms according to def. 3.9.20. The resulting definition essentially reproduces that of differential cohomology in terms of homotopy pullbacks as discussed in [HoSi05], but is formulated entirely internal to a cohesive ∞ -topos. Therefore it refines the construction of [HoSi05] in two ways¹²:

1. The coefficient object may be a cohesive ∞ -groupoid, where in [HoSi05] it is just a topological space, hence, as explained below in 4.2, a *discrete* ∞ -groupoid.
2. The domain object may also be a cohesive ∞ -groupoid, where in [HoSi05] it is restricted to be a manifold. In particular it can be an orbifold, or itself a moduli stack.

We give below an intrinsic characterization of domain objects that are manifolds in the sense of def. 3.9.9. On more general objects our definition subsumes also a notion of *equivariant* differential cohomology.

Definition 3.9.34. For \mathbb{G} a braided ∞ -group in \mathbf{H} , def. 3.6.116, the *moduli of closed 2-forms* with values in \mathbb{G} is a morphism

$$\Omega_{\mathrm{cl}}^2(-, \mathbb{G}) \longrightarrow \flat_{\mathrm{dR}}\mathbf{B}^2\mathbb{G}$$

characterized as follows:

¹² After we had proposed this refinement, in [Ho11] it says that this is the context to which the article [HoSi05] was intended to be refined.

1. $\Omega_{\text{cl}}^2(-, \mathbb{G}) \in \mathbf{H}$ is 0-truncated;
2. for every \mathbb{A}^1 -manifold $\Sigma \in \mathbf{H}$, def. 3.6.116, we have that

$$[\Sigma, \iota] : [\Sigma, \Omega_{\text{cl}}^2(-, \mathbb{G})] \longrightarrow [\Sigma, \mathfrak{b}_{\text{dR}} \mathbf{B}^2 \mathbb{G}]$$

is an epimorphism

3. ι is universal with the above two properties.

A morphism $\omega_X : \Omega_{\text{cl}}^2(-, \mathbb{G})$ we call a *closed Lie(\mathbb{G})-valued differential 2-form on X* , or a *pre-symplectic structure on X* , with values in $\text{Lie}(\mathbb{G})$.

Definition 3.9.35. For \mathbb{G} a braided ∞ -group, we write

$$\mathbf{B}\mathbb{G}_{\text{conn}} := \mathbf{B}\mathbb{G} \times_{\mathfrak{b}_{\text{dR}} \mathbf{B}^2 \mathbb{G}} \Omega^2(-, \mathbb{G})$$

for the ∞ -fiber product in

$$\begin{array}{ccc} \mathbf{B}\mathbb{G}_{\text{conn}} & \xrightarrow{F(-)} & \Omega^2(-, \mathbb{G}) \\ \downarrow U & & \downarrow \\ \mathbf{B}\mathbb{G} & \xrightarrow{\text{curv}_{\mathbb{G}}} & \mathfrak{b}_{\text{dR}} \mathbf{B}^2 \mathbb{G} \end{array} .$$

We say that

1. $\mathbf{B}\mathbb{G}_{\text{conn}}$ is the *moduli object for differential cocycles with coefficients in \mathbb{G}* or equivalently for \mathbb{G} -*principal connections*;
2. For $\nabla : X \rightarrow \mathbf{B}\mathbb{G}_{\text{conn}}$ we say that
 - (a) $F_{\nabla} : X \rightarrow \Omega^2(-, \mathbb{G})$ is the *curvature form* of ∇
 - (b) that $U(\nabla) : X \rightarrow \mathbf{B}\mathbb{G}$ is (the morphism modulation) the *underlying \mathbb{G} -principal bundle* of ∇ .

Proposition 3.9.36. For $\mathbb{G} \in \text{Grp}(\mathbf{H})$ a braided ∞ -group, the loop space object, def. 3.6.111, of $\mathbf{B}\mathbb{G}_{\text{conn}}$ is equivalent to the flat coefficient object $\mathfrak{b}\mathbb{G}$

$$\Omega \mathbf{B}\mathbb{G}_{\text{conn}} \simeq \mathfrak{b}\mathbb{G} .$$

Proof. Using that $\Omega_{\text{cl}}(-, \mathbb{G})$ is 0-truncated by definition, using that \mathfrak{b} is right adjoint and hence commutes with ∞ -pullbacks and repeatedly using the pasting law, prop. 2.3.2, we find a pasting diagram of ∞ -pullbacks of the form

$$\begin{array}{ccccccc} \mathfrak{b}\mathbb{G} & \longrightarrow & \mathbb{G} & \longrightarrow & * & & \\ \downarrow & & \downarrow & & \downarrow & & \\ * & \longrightarrow & \mathfrak{b}_{\text{dR}} \mathbf{B}\mathbb{G} & \longrightarrow & \mathfrak{b}\mathbf{B}\mathbb{G} & \longrightarrow & * \\ \downarrow & & \downarrow & & \downarrow & & \downarrow \\ * & \longrightarrow & \mathbf{B}\mathbb{G}_{\text{conn}} & \longrightarrow & \Omega_{\text{cl}}(-, \mathbb{G}) & & \\ \downarrow & & \downarrow & & \downarrow & & \\ * & \longrightarrow & \mathbf{B}\mathbb{G} & \longrightarrow & \mathfrak{b}_{\text{dR}} \mathbf{B}^2 \mathbb{G} & & \end{array}$$

□

3.9.6.3 Ordinary differential cohomology We now spell out the constructions of 3.9.6.2 in more detail for the special case that \mathbb{G} is an Eilenberg-MacLane object, hence for the case there is a 0-truncated abelian group object $A \in \text{Grp}(\tau_{\leq 0}\mathbf{H}) \hookrightarrow \mathbf{H}$ and $n \in \mathbb{N}$ such that

$$\mathbf{B}\mathbb{G} \simeq \mathbf{B}^n A.$$

This is the case of *ordinary differential cohomology* that refines what the *ordinary cohomology* with coefficients in A , according to remark 3.6.135. The explicit realization of this construction in smooth cohesion is discussed below in 4.4.16.

By the discussion in 3.6.8 we have for all $n \in \mathbb{N}$ the corresponding Eilenberg-MacLane object $\mathbf{B}^n A$. By the discussion in 3.6.10 this classifies $\mathbf{B}^{n-1}A$ -principal ∞ -bundles in that for any $X \in \mathbf{H}$ we have an equivalence of n -groupoids

$$\mathbf{B}^{n-1}A\text{Bund}(X) \simeq \mathbf{H}(X, \mathbf{B}^n A)$$

whose objects are $\mathbf{B}^{n-1}A$ -principal ∞ -bundles on X , whose morphisms are gauge transformations between these, and so on. The following definition refines this by equipping these ∞ -bundles with the structure of a *connection*.

Let $A^1 \in \mathbf{H}$ be a line object *exhibiting the cohesion* of \mathbf{H} in the sense of def. 3.9.2. Let then furthermore for each $n \in \mathbb{N}$

$$\Omega_{\text{cl}}^n(-, A) \rightarrow \mathfrak{b}_{\text{dR}}\mathbf{B}^n A$$

be a choice of differential form objects, according to def. 3.9.20.

Definition 3.9.37. For $X \in \mathbf{H}$ any object and $n \geq 1$ write

$$\mathbf{H}_{\text{diff}}(X, \mathbf{B}^n A) := \mathbf{H}(X, \mathbf{B}^n A) \prod_{\mathbf{H}_{\text{dR}}(X, \mathbf{B}^n A)} H_{\text{dR}}^{n+1}(X, A)$$

for the cocycle ∞ -groupoid of *twisted cohomology*, 3.6.12, of X with coefficients in A relative to the canonical curvature characteristic morphism $\text{curv} : \mathbf{B}^n A \rightarrow \mathfrak{b}_{\text{dR}}\mathbf{B}^{n+1}A$ (3.9.5). By prop. 3.6.218 this is the ∞ -pullback

$$\begin{array}{ccc} \mathbf{H}_{\text{diff}}(X, \mathbf{B}^n A) & \xrightarrow{[F]} & H_{\text{dR}}^{n+1}(X, A) \\ \downarrow c & & \downarrow \\ \mathbf{H}(X, \mathbf{B}^n A) & \xrightarrow{\text{curv}_*} & \mathbf{H}_{\text{dR}}(X, \mathbf{B}^{n+1}A) \end{array},$$

where the right vertical morphism $\pi_0\mathbf{H}_{\text{dR}}(X, \mathbf{B}^{n+1}A) \rightarrow \mathbf{H}_{\text{dR}}(X, \mathbf{B}^{n+1}A)$ is the unique, up to equivalence, effective epimorphism out of a 0-truncated object: a choice of cocycle representative in each cohomology class, equivalently a choice of point in every connected component.

We call

$$H_{\text{diff}}^n(X, A) := \pi_0\mathbf{H}_{\text{diff}}(X, \mathbf{B}^n A)$$

the degree- n *differential cohomology* of X with coefficient in A .

For $\nabla \in \mathbf{H}_{\text{diff}}(X, \mathbf{B}^n A)$ a cocycle, we call

- $[c(\nabla)] \in H^n(X, A)$ the *characteristic class* of the *underlying $\mathbf{B}^{n-1}A$ -principal ∞ -bundle*;
- $[F](\nabla) \in H_{\text{dR}}^{n+1}(X, A)$ the *curvature class* of c (this is the *twist*).

We also say that ∇ is an ∞ -*connection* on the principal ∞ -bundle $\eta(\nabla)$.

Observation 3.9.38. The differential cohomology $H_{\text{diff}}^n(X, A)$ does not depend on the choice of morphism $H_{\text{dR}}^{n+1}(X, A) \rightarrow \mathbf{H}_{\text{dR}}(X, \mathbf{B}^{n+1}A)$ (as long as it is an isomorphism on π_0 , as required). In fact, for different choices the corresponding cocycle ∞ -groupoids $\mathbf{H}_{\text{diff}}(X, \mathbf{B}^n A)$ are equivalent.

Proof. The set

$$H_{\text{dR}}^{n+1}(X, A) = \coprod_{H_{\text{dR}}^{n+1}(X, A)} *$$

is, as a 0-truncated ∞ -groupoid, an ∞ -coproduct of the terminal object ∞Grpd . By universal colimits in this ∞ -topos we have that ∞ -colimits are preserved by ∞ -pullbacks, so that $\mathbf{H}_{\text{diff}}(X, \mathbf{B}^n A)$ is the coproduct

$$\mathbf{H}_{\text{diff}}(X, \mathbf{B}^n A) \simeq \coprod_{H_{\text{dR}}^{n+1}(X, A)} \left(\mathbf{H}(X, \mathbf{B}^n A)_{\mathbf{H}_{\text{dR}} \times (X, \mathbf{B}^{n+1} A)}^* \right)$$

of the homotopy fibers of curv_* over each of the chosen points $* \rightarrow \mathbf{H}_{\text{dR}}(X, \mathbf{B}^{n+1} A)$. These homotopy fibers only depend, up to equivalence, on the connected component over which they are taken. \square

Proposition 3.9.39. *When restricted to vanishing curvature, differential cohomology coincides with flat differential cohomology, 3.8.5,*

$$H_{\text{diff}}^n(X, A)|_{[F]=0} \simeq H_{\text{flat}}(X, \mathbf{B}^n A).$$

Moreover this is true at the level of cocycle ∞ -groupoids

$$\left(\mathbf{H}_{\text{diff}}(X, \mathbf{B}^n A) \times_{H_{\text{dR}}^{n+1}(X, A)} \{[F] = 0\} \right) \simeq \mathbf{H}_{\text{flat}}(X, \mathbf{B}^n A),$$

hence there is a canonical embedding by a full and faithful morphism

$$\mathbf{H}_{\text{flat}}(X, \mathbf{B}^n A) \hookrightarrow \mathbf{H}_{\text{diff}}(X, \mathbf{B}^n A)$$

Proof. By the pasting law for ∞ -pullbacks, prop. 2.3.2, the claim is equivalently that we have a pasting of ∞ -pullback diagrams

$$\begin{array}{ccc} \mathbf{H}_{\text{flat}}(X, \mathbf{B}^n A) & \longrightarrow & * \\ \downarrow & & \downarrow [F]=0 \\ \mathbf{H}_{\text{diff}}(X, \mathbf{B}^n A) & \xrightarrow{[F]} & H_{\text{dR}}^{n+1}(X, A) \\ \downarrow \eta & & \downarrow \\ \mathbf{H}(X, \mathbf{B}^n A) & \xrightarrow{\text{curv}_*} & \mathbf{H}_{\text{dR}}(X, \mathbf{B}^{n+1} A) \end{array} .$$

By definition of flat cohomology, def. 3.8.13 and of intrinsic de Rham cohomology, def. 3.9.15, in \mathbf{H} , the outer rectangle is

$$\begin{array}{ccc} \mathbf{H}(X, \mathbf{b}\mathbf{B}^n A) & \longrightarrow & * \\ \downarrow & & \downarrow \\ \mathbf{H}(X, \mathbf{B}^n A) & \xrightarrow{\text{curv}_*} & \mathbf{H}(X, \mathbf{b}_{\text{dR}}\mathbf{B}^{n+1} A) \end{array} .$$

Since the hom-functor $\mathbf{H}(X, -)$ preserves ∞ -limits this is a pullback if

$$\begin{array}{ccc} \mathbf{b}\mathbf{B}^n A & \longrightarrow & * \\ \downarrow & & \downarrow \\ \mathbf{B}^n A & \xrightarrow{\text{curv}} & \mathbf{b}_{\text{dR}}\mathbf{B}^{n+1} A \end{array}$$

is. Indeed, this is one step in the fiber sequence

$$\dots \rightarrow \mathbf{b}\mathbf{B}^n A \rightarrow \mathbf{B}^n A \xrightarrow{\text{curv}} \mathbf{b}_{\text{dR}}\mathbf{B}^{n+1} A \rightarrow \mathbf{b}\mathbf{B}^{n+1} A \rightarrow \mathbf{B}^{n+1} A$$

that defines curv (using that \flat preserves limits and hence looping and delooping).

Finally, $* \xrightarrow{[F]=0} H_{\text{dR}}^{n-1}(X, A)$ is, trivially, a monomorphism of sets, hence a full and faithful morphism of ∞ -groupoids, and since these are stable under ∞ -pullback, it follows that the canonical inclusion of flat ∞ -connections into all ∞ -connections is also full and faithful. \square

The following establishes the characteristic short exact sequences that characterizes intrinsic differential cohomology as an extension of curvature forms by flat ∞ -bundles and of bare ∞ -bundles by connection forms.

Proposition 3.9.40. *Let $\text{im}F \subset H_{\text{dR}}^{n+1}(X, A)$ be the image of the curvatures. Then the differential cohomology group $H_{\text{diff}}^n(X, A)$ fits into a short exact sequence*

$$0 \rightarrow H_{\text{flat}}^n(X, A) \rightarrow H_{\text{diff}}^n(X, A) \rightarrow \text{im}F \rightarrow 0$$

Proof. Form the long exact sequence in homotopy groups of the fiber sequence

$$\mathbf{H}_{\text{flat}}(X, \mathbf{B}^n A) \rightarrow \mathbf{H}_{\text{diff}}(X, \mathbf{B}^n A) \xrightarrow{[F]} H_{\text{dR}}^{n+1}(X, A)$$

of prop. 3.9.39 and use that $H_{\text{dR}}^{n+1}(X, A)$ is, as a set – a homotopy 0-type – to get the short exact sequence on the bottom of this diagram

$$\begin{array}{ccccccc} \pi_1(H_{\text{dR}}(X, A)) & \longrightarrow & \pi_0(\mathbf{H}_{\text{flat}}(X, \mathbf{B}^n A)) & \longrightarrow & \pi_0(\mathbf{H}_{\text{diff}}(X, \mathbf{B}^n A)) & \xrightarrow{[F]} & \pi_0(H_{\text{dR}}^{n+1}(X, A)) \\ \parallel & & \parallel & & \parallel & & \downarrow \\ 0 & \longrightarrow & H_{\text{flat}}^n(X, A) & \longrightarrow & H_{\text{diff}}^n(X, A) & \longrightarrow & \text{im}[F] \end{array}$$

\square

Proposition 3.9.41. *The differential cohomology group $H_{\text{diff}}^n(X, A)$ fits into a short exact sequence of abelian groups*

$$0 \rightarrow H_{\text{dR}}^n(X, A)/H^{n-1}(X, A) \rightarrow H_{\text{diff}}^n(X, A) \xrightarrow{\text{c}} H^n(X, A) \rightarrow 0.$$

Proof. We claim that for all $n \geq 1$ we have a fiber sequence

$$\mathbf{H}(X, \mathbf{B}^{n-1} A) \rightarrow \mathbf{H}_{\text{dR}}(X, \mathbf{B}^n A) \rightarrow \mathbf{H}_{\text{diff}}(X, \mathbf{B}^n A) \rightarrow \mathbf{H}(X, \mathbf{B}^n A)$$

in ∞Grpd . This implies the short exact sequence using that by construction the last morphism is surjective on connected components (because in the defining ∞ -pullback for \mathbf{H}_{diff} the right vertical morphism is by assumption surjective on connected components).

To see that we do have the fiber sequence as claimed, consider the pasting composite of ∞ -pullbacks

$$\begin{array}{ccccc} \mathbf{H}_{\text{dR}}(X, \mathbf{B}^{n-1} A) & \longrightarrow & \mathbf{H}_{\text{diff}}(X, \mathbf{B}^n A) & \longrightarrow & H_{\text{dR}}(X, \mathbf{B}^{n+1} A) \\ \downarrow & & \downarrow & & \downarrow \\ * & \longrightarrow & \mathbf{H}(X, \mathbf{B}^n A) & \xrightarrow{\text{curv}} & H_{\text{dR}}(X, \mathbf{B}^{n+1} A) \end{array}$$

The square on the right is a pullback by def. 3.9.37. Since also the square on the left is assumed to be an ∞ -pullback it follows by the pasting law for ∞ -pullbacks, prop. 2.3.2, that the top left object is the ∞ -pullback of the total rectangle diagram. That total diagram is

$$\begin{array}{ccc} \Omega\mathbf{H}(X, \flat_{\text{dR}} \mathbf{B}^{n+1} A) & \longrightarrow & H(X, \flat_{\text{dR}} \mathbf{B}^{n+1} A) \\ \downarrow & & \downarrow \\ * & \longrightarrow & \mathbf{H}(X, \flat_{\text{dR}} \mathbf{B}^{n+1} A) \end{array},$$

because, as before, this ∞ -pullback is the coproduct of the homotopy fibers, and they are empty over the connected components not in the image of the bottom morphism and are the loop space object over the single connected component that is in the image.

Finally using that

$$\Omega \mathbf{H}(X, \flat_{\mathrm{dR}} \mathbf{B}^{n+1} A) \simeq \mathbf{H}(X, \Omega \flat_{\mathrm{dR}} \mathbf{B}^{n+1} A)$$

and

$$\Omega \flat_{\mathrm{dR}} \mathbf{B}^{n+1} A \simeq \flat_{\mathrm{dR}} \Omega \mathbf{B}^{n+1} A$$

since both $\mathbf{H}(X, -)$ as well as \flat_{dR} preserve ∞ -limits and hence formation of loop space objects, the claim follows. \square

Often it is desirable to restrict attention to differential cohomology over domains on which the twisting cocycles can be chosen functorially. This we consider now.

Definition 3.9.42. For any $n \in \mathbb{N}$ write $\mathbf{B}^n A_{\mathrm{conn}}$ for the ∞ -pullback

$$\begin{array}{ccc} \mathbf{B}^n A_{\mathrm{conn}} & \longrightarrow & \Omega_{\mathrm{cl}}^{n+1}(-, A) \\ \downarrow & & \downarrow \\ \mathbf{B}^n A & \xrightarrow{\mathrm{curv}} & \flat_{\mathrm{dR}} \mathbf{B}^{n+1} A \end{array}$$

in \mathbf{H} .

For X an A -dR-projective object we write

$$H_{\mathrm{conn}}^n(X, A) := \pi_0 \mathbf{H}(X, \mathbf{B}^n A_{\mathrm{conn}})$$

for the cohomology group on X with coefficients in $\mathbf{B}^n A_{\mathrm{conn}}$.

The objects $\mathbf{B}^n A_{\mathrm{conn}}$ represent differential cohomology in the following sense.

Observation 3.9.43. For every A -dR-projective object X there is a full and faithful morphism

$$\mathbf{H}_{\mathrm{diff}}(X, \mathbf{B}^n A) \hookrightarrow \mathbf{H}(X, \mathbf{B}^n A_{\mathrm{conn}}),$$

hence in particular an inclusion

$$H_{\mathrm{diff}}^n(X, A) \hookrightarrow H_{\mathrm{conn}}^n(X, A).$$

Proof. Since $\Omega_{\mathrm{cl}}^{n+1}(X, A) \rightarrow H_{\mathrm{dR}}^{n+1}(X, A)$ is a surjection by definition, there exists a factorization

$$H_{\mathrm{dR}}^{n+1}(X, A) \hookrightarrow \Omega_{\mathrm{cl}}^{n+1}(X, A) \rightarrow \mathbf{H}(X, \flat_{\mathrm{dR}} \mathbf{B}^{n+1} A)$$

of the canonical effective epimorphism (well defined up to homotopy), where the first morphism is an injection of sets, hence a monomorphism of ∞ -groupoids. Since these are stable under ∞ -pullback, it follows that also the top left morphism in the pasting diagram of ∞ -pullbacks

$$\begin{array}{ccc} \mathbf{H}_{\mathrm{diff}}(X, \mathbf{B}^n A) & \longrightarrow & H_{\mathrm{dR}}^{n+1}(X, A) \\ \downarrow & & \downarrow \\ \mathbf{H}(X, \mathbf{B}^n A_{\mathrm{conn}}) & \longrightarrow & \Omega_{\mathrm{cl}}^{n+1}(X, A) \\ \downarrow & & \downarrow \\ \mathbf{H}(X, \mathbf{B}^n A) & \xrightarrow{\mathrm{curv}} & \mathbf{H}(X, \flat_{\mathrm{dR}} \mathbf{B}^{n+1} A) \end{array}$$

is a monomorphism.

Notice that here the bottom square is indeed an ∞ -pullback, by def. 3.9.42 combined with the fact that the hom-functor $\mathbf{H}(X, -) : \mathbf{H} \rightarrow \infty\text{Grpd}$ preserves ∞ -pullbacks, and that with the top square defined to be an ∞ -pullback the total outer rectangle is an ∞ -pullback by prop. 2.3.2. This identifies the top left object as $\mathbf{H}_{\text{diff}}(X, \mathbf{B}^n A)$ by def. 3.9.37. \square

The reason that prop. 3.9.43 gives inclusion is that $H_{\text{conn}}^n(X, A)$ contains connections for all possible curvature forms, while $H_{\text{diff}}^n(X, A)$ contains only connections for one curvature representative in each de Rham cohomology class. This is made precise by the following refinement of the exact sequences from prop. 3.9.40 and prop. 3.9.41.

Definition 3.9.44. Write

$$\Omega_{\text{cl,int}}^n(-, A) \hookrightarrow \Omega_{\text{cl}}^n(-, A)$$

for the image factorization of the canonical morphism $\mathbf{B}^n A_{\text{conn}} \rightarrow \Omega_{\text{cl}}^n(-, A)$ from def. 3.9.42.

Proposition 3.9.45. For X an A -dR-projective object we have a short exact sequence of groups

$$H_{\text{flat}}^n(X, A) \longrightarrow H_{\text{conn}}^n(X, A) \xrightarrow{\text{curv}} \Omega_{\text{cl,int}}^{n+1}(X, A) .$$

Proof. As in the proof of prop. 3.9.39 we have a pasting diagram of ∞ -pullbacks

$$\begin{array}{ccccc} * & \longrightarrow & \mathbf{H}(X, \mathbf{b}\mathbf{B}^n A) & \longrightarrow & * \\ \downarrow & & \downarrow & & \downarrow 0 \\ * & \longrightarrow & \mathbf{H}(X, \mathbf{B}^n A_{\text{conn}}) & \longrightarrow & \Omega_{\text{cl,int}}^{n+1}(X, A) \hookrightarrow \Omega_{\text{cl}}^{n+1}(X, A) \\ & & \downarrow & & \downarrow \\ & & \mathbf{H}(X, \mathbf{B}^n A) & \xrightarrow{\text{curv}} & \mathbf{H}(X, \mathbf{b}_{\text{dR}}\mathbf{B}^{n+1} A) \end{array} .$$

After passing to connected components, this implies the claim. \square

Details on how traditional ordinary differential cohomology is recovered by implementing the above in the context of smooth cohesion are discussed in 4.4.16.

3.9.6.4 Differential moduli We discuss issues related to the formulation of *moduli objects* in a cohesive ∞ -topos for differential cocycles as discussed above, over a fixed base object.

To motivate this consider the following. Given a coefficient object $\mathbf{B}\mathbb{G}_{\text{conn}} \in \mathbf{H}$ for differential cohomology as discussed above, and given any object $X \in \mathbf{H}$, the mapping space object $[X, \mathbf{B}\mathbb{G}_{\text{conn}}] \in \mathbf{H}$ is a kind of moduli object for \mathbb{G} -differential cocycles on X , in that its global points are precisely such cocycles. However, for any $U \in \mathbf{H}$ a U -plot of $[X, \mathbf{B}\mathbb{G}_{\text{conn}}]$ may be more general than just a cohesively parameterized U -collection of such cocycles on X , because it is actually a differential cocycle on $U \times X$ and hence may contain nontrivial differential/connection data along U , not just along X .

In some applications this behaviour of $[X, \mathbf{B}\mathbb{G}_{\text{conn}}]$ is exactly what is needed. This is notably the case for the construction of extended Chern-Simons action functionals in all codimensions, discussed below in 3.9.11. But in other applications, such as the construction of the extended phase spaces of Chern-Simons functionals, one rather needs to have an object of genuine *differential moduli*, which is such that its U -plots are genuine U -parameterized collections of differential cocycles (and their gauge transformations) just on X . This issue is discussed in more detail with illustrative examples in the model of smooth cohesion below in 4.4.16.3.

Here we discuss how such differential moduli objects are obtained general abstractly in a cohesive ∞ -topos from a *degreewise concretification* of the mapping space objects $[X, \mathbf{B}\mathbb{G}_{\text{conn}}]$ in the sense of 3.7.2.

Definition 3.9.46. Let $\mathbb{G} \in \text{Grp}(\mathbf{H})$ be a braided ∞ -group, def. 3.6.116, which is exactly $n - 1$ -truncated, def. 3.6.22. Then for $k \leq n + 1 \in \mathbb{N}$ write $\mathbf{B}\mathbb{G}_{\text{conn}^k}$ for the ∞ -pullback in

$$\begin{array}{ccc} \mathbf{B}\mathbb{G}_{\text{conn}^k} & \longrightarrow & \Omega^{n+1 \leq \bullet \leq k}(-, \mathbb{G}) \\ \downarrow & & \downarrow \\ \mathbf{B}\mathbb{G} & \xrightarrow{\text{curv}_{\mathbb{G}}} & \mathfrak{b}_{\text{dR}}\mathbf{B}^2\mathbb{G} \end{array}$$

Remark 3.9.47. For A a 0-truncated abelian group and $\mathbb{G} \simeq \mathbf{B}A$, the objects $\mathbf{B}^2A_{\text{conn}^1}$ of def. 3.9.46 modulates what in the literature is oft known as a *bundle gerbe with connective data but without curving*. In this context then the structures modulated by $\mathbf{B}^2_{\text{conn}^2} \simeq \mathbf{B}^2A_{\text{conn}}$ would be called *bundles gerbes with connective data and with curving*. We discuss this in more detail in 4.4.16 below.

Remark 3.9.48. The objects $\mathbf{B}\mathbb{G}_{\text{conn}^k}$ of def. 3.9.46 play two key roles:

1. They appear as an ingredient in the construction of differential moduli stacks in def. 3.9.50 below. Here their role is mainly a technical one: the object of interest is really $\mathbf{B}\mathbb{G}_{\text{conn}}$ and the $\mathbf{B}\mathbb{G}_{\text{conn}^k}$ just serve to refine its structure.
2. They appear as variant differential coefficients in their own right in various contexts, for instance in the context of higher Atiyah Lie algebroids and Courant Lie algebroids in 3.9.13.6 below.

Remark 3.9.49. By the universal property of the ∞ -pullback, the canonical tower of morphisms

$$\Omega_{\text{cl}}^{n+1} \longrightarrow \Omega_{\text{cl}}^{n+1 \leq \bullet \leq n} \longrightarrow \dots \longrightarrow \Omega_{\text{cl}}^{n+1 \leq \bullet \leq 1} \xrightarrow{\simeq} \mathfrak{b}_{\text{dR}}\mathbf{B}^2\mathbb{G}$$

induces a tower of morphisms

$$\mathbf{B}\mathbb{G}_{\text{conn}} \xrightarrow{\simeq} \mathbf{B}\mathbb{G}_{\text{conn}^n} \longrightarrow \mathbf{B}\mathbb{G}_{\text{conn}^{n-1}} \longrightarrow \dots \longrightarrow \mathbf{B}\mathbb{G}_{\text{conn}^0} \xrightarrow{\simeq} \mathbf{B}\mathbb{G} .$$

Definition 3.9.50. For $X \in \mathbf{H}$ and $n \in \mathbb{N}$, $n \geq 1$, $\mathbb{G} \in \text{Grp}(\mathbf{H})$ a braided ∞ -group which is precisely $(n - 1)$ -truncated, then the *moduli of \mathbb{G} -principal connections* on X is the iterated ∞ -fiber product

$$\begin{aligned} & \mathbb{G}\text{Conn}(X) \\ & := \#_1[X, \mathbf{B}\mathbb{G}_{\text{conn}^n}] \times_{\#_1[X, \mathbf{B}\mathbb{G}_{\text{conn}^{n-1}}]} \#_2[X, \mathbf{B}\mathbb{G}_{\text{conn}^{n-1}}] \times_{\#_2[X, \mathbf{B}\mathbb{G}_{\text{conn}^{n-2}}]} \dots \times_{\#_n[X, \mathbf{B}\mathbb{G}_{\text{conn}^0}]} [X, \mathbf{B}\mathbb{G}_{\text{conn}^0}] , \end{aligned}$$

of the morphisms

$$\#_k[X, \mathbf{B}\mathbb{G}_{\text{conn}^{n-k+1}}] \longrightarrow \#_k[X, \mathbf{B}\mathbb{G}_{\text{conn}^{n-k}}]$$

which are the image under $\#_k$, def. 3.7.6, of the image under the internal hom $[X, -]$ of the canonical projections of remark 3.9.49, and of the morphisms

$$\#_{k+1}[X, \mathbf{B}^n U(1)_{\text{conn}^{n-k}}] \longrightarrow \#_k[X, \mathbf{B}^n U(1)_{\text{conn}^{n-k}}]$$

of def. 3.7.6.

Remark 3.9.51. By the universal property of the ∞ -pullback, the commuting naturality diagrams

$$\begin{array}{ccc} \#_{k_2}[X, \mathbf{B}\mathbb{G}_{\text{conn}^{n_2}}] & \longrightarrow & \#_{k_2}[X, \mathbf{B}\mathbb{G}_{\text{conn}^{n_1}}] \\ \downarrow & & \downarrow \\ \#_{k_1}[X, \mathbf{B}\mathbb{G}_{\text{conn}^{n_2}}] & \longrightarrow & \#_{k_1}[X, \mathbf{B}\mathbb{G}_{\text{conn}^{n_1}}] \end{array}$$

induce a canonical projection

$$\text{conc} : [X, \mathbf{BG}_{\text{conn}}] \longrightarrow G\text{Conn}(X)$$

from the mapping space object into the object of differential moduli. We call this *differential concretification*.

We need the analogous construction also for the $\mathbf{BG}_{\text{conn}^k}$ regarded as coefficient objects themselves. The following straightforwardly generalizes def. 3.9.50 from $k = n$ to arbitrary $k \leq n$.

Definition 3.9.52. For $X \in \mathbf{H}$ and $n \in \mathbb{N}$, $n \geq 1$, $0 \leq k \leq n$, $\mathbb{G} \in \text{Grp}(\mathbf{H})$ a braided ∞ -group which is precisely $(n - 1)$ -truncated, then the *moduli of \mathbb{G} -principal k -connections* on X is the iterated ∞ -fiber product

$$\mathbb{G}\text{Conn}_k(X) := \#_{n-k+1}[X, \mathbf{BG}_{\text{conn}^k}] \times_{\#_{n-k+1}[X, \mathbf{BG}_{\text{conn}^{k-1}}]} \#_{n-k+2}[X, \mathbf{BG}_{\text{conn}^{k-1}}] \times_{\#_{n-k+2}[X, \mathbf{BG}_{\text{conn}^{k-2}}]} \cdots \times_{\#_n[X, \mathbf{BG}_{\text{conn}^0}]} [X, \mathbf{BG}_{\text{conn}^0}] .$$

Remark 3.9.53. The projection maps out of the iterated ∞ -pullbacks induce a canonical sequence of projections

$$\mathbb{G}\text{Conn}(X) \simeq \mathbb{G}\text{Conn}_n(X) \longrightarrow \mathbb{G}\text{Conn}_{n-1}(X) \longrightarrow \cdots \longrightarrow \mathbb{G}\text{Conn}_1(X) \longrightarrow \mathbb{G}\text{Conn}_0(X) \simeq \mathbf{BG} .$$

3.9.6.5 Flat Differential moduli We now turn to defining moduli for *flat* differential cocycles.

Definition 3.9.54. For \mathbb{G} a braided ∞ -group which is precisely $(n - 1)$ -truncated, and for any $X \in \mathbf{H}$, we call the iterated ∞ -fiber product

$$\mathbb{G}\text{FlatConn}(X) := \#_1[X, \mathbf{bBG}] \times_{\#_1[X, \Omega(\mathbf{BG}_{\text{conn}^{n-1}})]} \#_1[X, \Omega(\mathbf{BG}_{\text{conn}^{n-1}})] \times_{\#_1[X, \Omega(\mathbf{BG}_{\text{conn}^{n-2}})]} \cdots \times_{\#_n[X, \Omega(\mathbf{BG}_{\text{conn}^0})]} [X, \mathbb{G}]$$

the *moduli object for flat \mathbb{G} -connections* on X .

Proposition 3.9.55. For \mathbf{BG} a truncated braided ∞ -group we have a natural equivalence

$$\mathbb{G}\text{FlatConn}(X) \simeq \Omega_0((\mathbf{BG})\text{Conn}(X)) .$$

Moreover, if \mathbf{H} has a set of generators being concrete objects (in particular if it has an ∞ -cohesive site of definition, def. 3.4.17) then for \mathbb{G} a 0-truncated ∞ -group and X geometrically connected (meaning that $\tau_0\Pi(X) \simeq *$), we have

$$\mathbb{G} \simeq \Omega_0(\mathbb{G}\text{Conn}(X))$$

Proof. Since forming loops is an ∞ -pullback operation, it commutes with the iterated ∞ -fiber product. Moreover, by prop. 3.6.47 it passes through the $\#_k$, while lowering their degree by one. Finally by prop. 3.9.36 we have

$$\Omega(\mathbf{B}^2G_{\text{conn}}) \simeq \mathbf{bBG} .$$

This gives the first claim. For the second, observe that with the same reasoning we obtain

$$\begin{aligned} \Omega(\mathbb{G}\text{Conn}(X)) &\simeq \Omega\left(\#_1[X, \mathbf{BG}_{\text{conn}}] \times_{\#_1[X, \mathbf{BG}]} [X, \mathbf{BG}]\right) \\ &\simeq \#_1[X, \mathbf{bG}] \times_{\#_1[X, \mathbb{G}]} [X, \mathbb{G}] \end{aligned}$$

Hence for any concrete $U \in \mathbf{H}$ we have

$$\begin{aligned}
\mathbf{H}(U, \Omega(\mathbb{G}\mathbf{Conn}(X))) &\simeq \infty\mathrm{Grpd}(\Gamma(U), \mathbf{H}(X, \flat\mathbb{G})) \times_{\infty\mathrm{Grpd}(\Gamma(U), \mathbf{H}(X, \mathbb{G}))} \mathbf{H}(U \times X, \mathbb{G}) \\
&\simeq \infty\mathrm{Grpd}(\Gamma(U) \times \Pi(X), \Gamma(\mathbb{G})) \times_{\infty\mathrm{Grpd}(\Gamma(U), \mathbf{H}(X, \mathbb{G}))} \mathbf{H}(U \times X, \mathbb{G}) \\
&\simeq \mathrm{Set}(\tau_0\Gamma(U), \Gamma(\mathbb{G})) \times_{\mathrm{Set}(\tau_0\Gamma(U), \mathbf{H}(X, \mathbb{G}))} \mathbf{H}(U \times X, \mathbb{G}) \\
&\simeq \mathbf{H}(U, \mathbb{G})
\end{aligned}$$

Here we used the defining adjunctions of cohesion and that \mathbb{G} is 0-truncated by assumption, so that $\mathbf{H}(-, \mathbb{G})$ takes values in sets. In the last step we used that U is concrete so that maps out of it are determined by their value on all global points of U . So the second but last row says in words “those maps out of $U \times X$ which for every point of U are independent of X ” and the last equivalence identifies that with the maps out of just U . Since these equivalences are all natural in U the claim follows by the assumption that the U s range over a set of generators (hence with the ∞ -Yoneda lemma, prop. 2.1.16, if the U s range over the objects of a site of definition). \square

3.9.7 Chern-Weil theory

We discuss an intrinsic realization of the Chern-Weil homomorphism [GHV73] in cohesive ∞ -toposes.

Definition 3.9.56. For G an ∞ -group and

$$\mathbf{c} : \mathbf{B}G \rightarrow \mathbf{B}^n A$$

a representative of a characteristic class $[\mathbf{c}] \in H^n(\mathbf{B}G, A)$ we say that the composite

$$\mathbf{c}_{\mathrm{dR}} : \mathbf{B}G \xrightarrow{\mathbf{c}} \mathbf{B}^n A \xrightarrow{\mathrm{curv}} \flat_{\mathrm{dR}} \mathbf{B}^{n+1} A$$

represents the *curvature characteristic class* $[\mathbf{c}_{\mathrm{dR}}] \in H_{\mathrm{dR}}^{n+1}(\mathbf{B}G, A)$. The induced map on cohomology

$$(\mathbf{c}_{\mathrm{dR}})_* : H^1(-, G) \rightarrow H_{\mathrm{dR}}^{n+1}(-, A)$$

we call the (unrefined) ∞ -Chern-Weil homomorphism induced by \mathbf{c} .

The following construction universally lifts the ∞ -Chern-Weil homomorphism from taking values in the de Rham cohomology to values in the differential cohomology of \mathbf{H} .

Definition 3.9.57. For $X \in \mathbf{H}$ any object, define the ∞ -groupoid $\mathbf{H}_{\mathrm{conn}}(X, \mathbf{B}G)$ as the ∞ -pullback

$$\begin{array}{ccc}
\mathbf{H}_{\mathrm{conn}}(X, \mathbf{B}G) & \xrightarrow{(\hat{\mathbf{c}}_i)_i} & \prod_{[\mathbf{c}_i] \in H^{n_i}(\mathbf{B}G, A); i \geq 1} \mathbf{H}_{\mathrm{diff}}(X, \mathbf{B}^{n_i} A) \\
\downarrow \eta & & \downarrow \\
\mathbf{H}(X, \mathbf{B}G) & \xrightarrow{(\mathbf{c}_i)_i} & \prod_{[\mathbf{c}_i] \in H^{n_i}(\mathbf{B}G, A); i \geq 1} \mathbf{H}(X, \mathbf{B}^{n_i} A)
\end{array}$$

We say

- a cocycle in $\nabla \in \mathbf{H}_{\mathrm{conn}}(X, \mathbf{B}G)$ is an ∞ -connection
- on the principal ∞ -bundle $\eta(\nabla)$;

- a morphism in $\mathbf{H}_{\text{conn}}(X, \mathbf{B}G)$ is a *gauge transformation* of connections;
- for each $[\mathbf{c}] \in H^n(\mathbf{B}G, A)$ the morphism

$$[\hat{\mathbf{c}}] : H_{\text{conn}}(X, \mathbf{B}G) \rightarrow H_{\text{diff}}^n(X, A)$$

is the (full/refined) ∞ -Chern-Weil homomorphism induced by the characteristic class $[\mathbf{c}]$.

Observation 3.9.58. Under the curvature projection $[F] : H_{\text{diff}}^n(X, A) \rightarrow H_{\text{dR}}^{n+1}(X, A)$ the refined Chern-Weil homomorphism for \mathbf{c} projects to the unrefined Chern-Weil homomorphism.

Proof. This is due to the existence of the pasting composite

$$\begin{array}{ccccc} \mathbf{H}_{\text{conn}}(X, \mathbf{B}G) & \xrightarrow{(\hat{\mathbf{c}})_i} & \prod_{[\mathbf{c}_i] \in H^{n_i}(\mathbf{B}G, A); i \geq 1} \mathbf{H}_{\text{diff}}(X, \mathbf{B}^{n_i} A) & \xrightarrow{[F]} & \prod_{[\mathbf{c}_i] \in H^{n_i}(\mathbf{B}G, A); i \geq 1} H_{\text{dR}}^{n_i+1}(X, A) \\ \downarrow \eta & & \downarrow & & \downarrow \\ \mathbf{H}(X, \mathbf{B}G) & \xrightarrow{(\mathbf{c})_i} & \prod_{[\mathbf{c}_i] \in H^{n_i}(\mathbf{B}G, A); i \geq 1} \mathbf{H}(X, \mathbf{B}^{n_i} A) & \xrightarrow{\text{curv}_*} & \prod_{[\mathbf{c}_i] \in H^{n_i}(\mathbf{B}G, A); i \geq 1} \mathbf{H}_{\text{dR}}(X, \mathbf{B}^{n_i+1}, A) \end{array}$$

of the defining ∞ -pullback for $\mathbf{H}_{\text{conn}}(X, \mathbf{B}G)$ with the products of the definition ∞ -pullbacks for the $\mathbf{H}_{\text{diff}}(X, \mathbf{B}^{n_i} A)$. \square

As before for abelian differential cohomology in 3.9.6, nonabelian differential cohomology is in general not representable, but becomes representable on a suitable collection of domains. To reflect this we expand def. 3.9.42 as follows.

Definition 3.9.59. Let $\mathbf{c} : \mathbf{B}G \rightarrow \mathbf{B}^n A$ be a characteristic map, and let $\mathbf{B}^n A_{\text{conn}}$ be a differential refinement as in def. 3.9.42. Then we write $\mathbf{B}G_{\text{conn}}$ for an object that fits into a factorization

$$\begin{array}{ccc} \mathbf{b}G & \xrightarrow{\mathbf{b}c} & \mathbf{b}B^n A \\ \downarrow & & \downarrow \\ \mathbf{B}G_{\text{conn}} & \xrightarrow{\hat{\mathbf{c}}} & \mathbf{B}^n A_{\text{conn}} \\ \downarrow & & \downarrow \\ \mathbf{B}G & \xrightarrow{\mathbf{c}} & \mathbf{B}^n A \end{array}$$

of the naturality diagram of the $(\text{Disc} \dashv \Gamma)$ -counit.

Warning 3.9.60. The object $\mathbf{B}G_{\text{conn}}$ here depends, in general, on the choices involved. But for the moment we find it convenient not to indicate this in the notation but have it be implied by the corresponding context.

3.9.8 Twisted differential structures

We discuss the differential refinement of *twisted cohomology*, def. 3.6.12. Following [SSS09c] we speak of *twisted differential \mathbf{c} -structures*.

Definition 3.9.61. For $\mathbf{c} : \mathbf{B}G \rightarrow \mathbf{B}^n A$ a characteristic map in a cohesive ∞ -topos \mathbf{H} , define for any $X \in \mathbf{H}$ the ∞ -groupoid $\mathbf{cStruc}_{\text{tw}}(X)$ to be the ∞ -pullback

$$\begin{array}{ccc} \mathbf{cStruc}_{\text{tw}}(X) & \xrightarrow{\text{tw}} & H^n(X, A) \\ \downarrow & & \downarrow \\ \mathbf{H}(X, \mathbf{B}G) & \xrightarrow{\mathbf{c}} & \mathbf{H}(X, \mathbf{B}^n A) \end{array} ,$$

where the vertical morphism on the right is the essentially unique effective epimorphism that picks on point in every connected component.

Let now \mathbf{H} be a cohesive ∞ -topos that canonically contains the circle group $A = U(1)$, such as $\text{Smooth}\infty\text{Grpd}$ and its variants. Then by 4.4.16 the intrinsic differential cohomology with $U(1)$ -coefficients reproduces traditional ordinary differential cohomology and by 4.4.17 we have models for the ∞ -connection coefficients $\mathbf{B}G_{\text{conn}}$. Using this we consider the differential refinement of def. 3.9.61 as follows.

Definition 3.9.62. For $\mathbf{c} : \mathbf{B}G \rightarrow \mathbf{B}^n U(1)$ a characteristic map as above, and for $\hat{\mathbf{c}} : \mathbf{B}G_{\text{conn}} \rightarrow \mathbf{B}^n U(1)_{\text{conn}}$ a differential refinement, we write $\hat{\mathbf{c}}\text{Struc}_{\text{tw}}(X)$ for the corresponding twisted cohomology, def. 3.6.222,

$$\begin{array}{ccc} \hat{\mathbf{c}}\text{Struc}_{\text{tw}}(X) & \xrightarrow{\text{tw}} & H_{\text{diff}}^n(X, U(1)) \\ \downarrow \chi & & \downarrow \\ \mathbf{H}(X, \mathbf{B}G_{\text{conn}}) & \xrightarrow{\hat{\mathbf{c}}} & \mathbf{H}(X, \mathbf{B}^n U(1)_{\text{conn}}) \end{array} \quad ,$$

We say $\hat{\mathbf{c}}\text{Struc}_{\text{tw}}(X)$ is the ∞ -groupoid of *twisted differential \mathbf{c} -structures* on X .

3.9.9 Higher holonomy

The notion of ∞ -connections in a cohesive ∞ -topos induces a notion of *higher holonomy*.

Definition 3.9.63. We say an object $\Sigma \in \mathbf{H}$ has *cohomological dimension* $\leq n \in \mathbb{N}$ if for all Eilenberg-MacLane objects $\mathbf{B}^{n+1}A$ the corresponding cohomology on Σ is trivial

$$H(\Sigma, \mathbf{B}^{n+1}A) \simeq *.$$

Let $\dim(\Sigma)$ be the maximum n for which this is true.

Observation 3.9.64. If Σ has cohomological dimension $\leq n$ then its de Rham cohomology, def. 3.9.15, vanishes in degree $k > n$

$$H_{\text{dR}}^{k>n}(\Sigma, A) \simeq *.$$

Proof. Since \flat is a right adjoint it preserves delooping and hence $\flat\mathbf{B}^k A \simeq \mathbf{B}^k \flat A$. It follows that

$$\begin{aligned} H_{\text{dR}}^k(\Sigma, A) &:= \pi_0 \mathbf{H}(\Sigma, \flat_{\text{dR}} \mathbf{B}^k A) \\ &\simeq \pi_0 \mathbf{H}(\Sigma, * \prod_{\mathbf{B}^k A} \mathbf{B}^k \flat A) \\ &\simeq \pi_0 \left(\mathbf{H}(\Sigma, *) \prod_{\mathbf{H}(\Sigma, \mathbf{B}^k A)} \mathbf{H}(\Sigma, \mathbf{B}^k \flat A) \right) \\ &\simeq \pi_0(*) \end{aligned}$$

□

Let now A be fixed as in 3.9.6.

Definition 3.9.65. Let $\Sigma \in \mathbf{H}$, $n \in \mathbb{N}$ with $\dim \Sigma \leq n$. We say that the composite

$$\int_{\Sigma} : \mathbf{H}_{\text{flat}}(\Sigma, \mathbf{B}^n A) \xrightarrow{\simeq} \infty\text{Gprd}(\Pi(\Sigma), \Pi(\mathbf{B}^n A)) \xrightarrow{\tau_{\leq n - \dim(\Sigma)}} \tau_{n - \dim(\Sigma)} \infty\text{Gprd}(\Pi(\Sigma), \Pi(\mathbf{B}^n A))$$

of the adjunction equivalence followed by truncation as indicated is the *flat holonomy* operation on flat ∞ -connections.

More generally, let

- $\nabla \in \mathbf{H}_{\text{diff}}(X, \mathbf{B}^n A)$ be a differential cocycle on some $X \in \mathbf{H}$

- $\phi : \Sigma \rightarrow X$ a morphism.

Write

$$\phi^* : \mathbf{H}_{\text{diff}}(X, \mathbf{B}^{n+1}A) \rightarrow \mathbf{H}_{\text{diff}}(\Sigma, \mathbf{B}^n A) \simeq \mathbf{H}_{\text{flat}}(\Sigma, \mathbf{B}^n A)$$

(using prop. 3.9.39) for the morphism on ∞ -pullbacks induced by the morphism of diagrams

$$\begin{array}{ccccc} \mathbf{H}(X, \mathbf{B}^n A) & \longrightarrow & \mathbf{H}_{\text{dR}}(X, \mathbf{B}^{n+1}A) & \longleftarrow & H_{\text{dR}}^{n+1}(X, A) \\ \downarrow \phi^* & & \downarrow \phi^* & & \downarrow \\ \mathbf{H}(\Sigma, \mathbf{B}^n A) & \longrightarrow & \mathbf{H}_{\text{dR}}(\Sigma, \mathbf{B}^{n+1}A) & \longleftarrow & * \end{array}$$

The *holonomy* of ∇ over σ is the flat holonomy of $\phi^*\nabla$:

$$\int_{\phi} \nabla := \int_{\Sigma} \phi^* \nabla.$$

This is a special case of the more general notion of transgression, 3.9.10.

3.9.10 Transgression

We discuss an intrinsic notion of *transgression* of differential cocycles to mapping spaces. This generalizes the notion of holonomy from 3.9.9 to the case of higher codimension.

Let $A \in \infty\text{Grp}(\mathbf{H})$ be an abelian group object and $\mathbf{B}^n A_{\text{conn}}$ a differential coefficient object, as in 3.9.6, for $n \in \mathbb{N}$.

Let $\Sigma \in \mathbf{H}$ be of cohomological dimension $k \leq n$, def. 3.9.63.

Definition 3.9.66. For $\hat{c} : \mathbf{B}G_{\text{conn}} \rightarrow \mathbf{B}^n A_{\text{conn}}$ a differential characteristic map as in def. 3.9.59, we say that the *transgression* of \hat{c} to $[\Sigma, \mathbf{B}G_{\text{conn}}]$ is the composite

$$\text{tg}_{\Sigma} \hat{c} : [\Sigma, \mathbf{B}G_{\text{conn}}] \xrightarrow{[\Sigma, \hat{c}]} [\Sigma, \mathbf{B}^n A_{\text{conn}}] \longrightarrow \text{conc}_{n-k} \tau_{n-k} [\Sigma, \mathbf{B}^n A_{\text{conn}}],$$

where $[-, -] : \mathbf{H} \times \mathbf{H} \rightarrow \mathbf{H}$ is the cartesian internal hom, where τ_{n-k} is $(n-k)$ -truncation, prop. 3.6.25, and where conc_{n-k} is $(n-k)$ -concretification from def. 3.7.7.

Remark 3.9.67. In the models we consider we find inclusions

$$\mathbf{B}^{n-k} A_{\text{conn}} \hookrightarrow \text{conc}_{n-k} \tau_{n-k} [\Sigma, \mathbf{B}^n A_{\text{conn}}].$$

In these cases truncation takes A -principal n -connections \hat{c} on $\mathbf{B}G_{\text{conn}}$ to A -principal $(n-k)$ -connections $\text{tg}_{\Sigma} \hat{c}$ on $[\Sigma, \mathbf{B}G_{\text{conn}}]$.

In particular for $k = n$ in this case the transgression is of the form

$$\text{tg}_{\Sigma} \hat{c} : [\Sigma, \mathbf{B}G_{\text{conn}}] \rightarrow A.$$

3.9.11 Chern-Simons functionals

Combining the refined ∞ -Chern-Weil homomorphism, 3.9.7 with the higher holonomy, 3.9.9, of the resulting ∞ -connections produces a notion of higher *Chern-Simons functionals* internal to any cohesive ∞ -topos. For a review of standard Chern-Simons functionals see [Fr95].

Definition 3.9.68. Let $\Sigma \in \mathbf{H}$ be of cohomological dimension $\dim \Sigma = n \in \mathbb{N}$ and let $\mathbf{c} : X \rightarrow \mathbf{B}^n A$ a representative of a characteristic class $[\mathbf{c}] \in H^n(X, A)$ for some object X . We say that the composite

$$\exp(S_{\mathbf{c}}(-)) : \mathbf{H}(\Sigma, X) \xrightarrow{\hat{\mathbf{c}}} \mathbf{H}_{\text{diff}}(\Sigma, \mathbf{B}^n A) \xrightarrow{\simeq} \mathbf{H}_{\text{flat}}(\Sigma, \mathbf{B}^n A) \xrightarrow{\int_{\Sigma}} \tau_{\leq 0} \infty \text{Grpd}(\Pi(\Sigma), \Pi \mathbf{B}^n A)$$

is the ∞ -Chern-Simons functional induced by \mathbf{c} on Σ .

Here $\hat{\mathbf{c}}$ denotes the refined Chern-Weil homomorphism, 3.9.7, induced by \mathbf{c} , and \int_{Σ} is the holonomy over Σ , 3.9.9, of the resulting n -bundle with connection.

Remark 3.9.69. In the language of σ -model quantum field theory the ingredients of this definition have the following interpretation

- Σ is the *worldvolume of a fundamental* $(\dim \Sigma - 1)$ -brane ;
- X is the *target space*;
- $\hat{\mathbf{c}}$ is the *background gauge field* on X ;
- the external hom $\mathbf{H}_{\text{conn}}(\Sigma, X)$ is the *space of worldvolume field configurations* $\phi : \Sigma \rightarrow X$ or *trajectories* of the brane in X ;
- $\exp(S_{\mathbf{c}}(\phi)) = \int_{\Sigma} \phi^* \hat{\mathbf{c}}$ is the value of the action functional on the field configuration ϕ .

Traditionally, σ -models have been considered for X an ordinary (Riemannian) manifold, or at most an orbifold, see for instance [DeMo99]. The observation that it makes sense to allow target objects X to be more generally a gerbe, 3.6.15, is explored in [PaSh05] [HeSh10]. Here we see that once we pass to fully general (higher) stacks, then also all (higher) gauge theories are subsumed as σ -models.

For if there is an ∞ -group G such that the target space object X is the moduli ∞ -stack of G - ∞ -connections, def. 3.9.59, $X \simeq \mathbf{B}G_{\text{conn}}$, then a “trajectory” $\Sigma \rightarrow X \simeq \mathbf{B}G_{\text{conn}}$ is in fact a G -gauge field on Σ . Hence in the context of ∞ -stacks, the notions of gauge theories and of σ -models unify.

More in detail, assume that \mathbf{H} has a canonical line object \mathbb{A}^1 and a natural numbers object \mathbb{Z} . Then the action functional $\exp(iS(-))$ may lift to the internal hom with respect to the canonical cartesian closed monoidal structure on any ∞ -topos to a morphism of the form

$$\exp(iS_{\mathbf{c}}(-)) : [\Sigma, \mathbf{B}G_{\text{conn}}] \rightarrow \mathbf{B}^{n-\dim \Sigma} \mathbb{A}^1 / \mathbb{Z}.$$

We call the internal hom $[\Sigma, \mathbf{B}G_{\text{conn}}]$ the *moduli ∞ -stack* of field configurations on Σ of the ∞ -Chern-Simons theory defined by \mathbf{c} and $\exp(iS_{\mathbf{c}}(-))$ the action functional in codimension $(n - \dim \Sigma)$ defined on it.

A list of examples of Chern-Simons action functionals defined on moduli stacks obtained this way is given in 4.4.19.

3.9.12 Wess-Zumino-Witten functionals

We discuss a canonical realization of Wess-Zumino-Witten action functionals and their higher analogs in every cohesive ∞ -topos.

For a review of traditional WZW functionals see for instance [Ga00] and see below in 5.6.

In higher (super-)differential geometry every (super-) L_{∞} -algebra \mathfrak{g} has *Lie integrations* to higher smooth (super-)groups G ; see [FSS10] for details. For instance, the abelian L_{∞} -algebra $\mathbb{R}[n]$ integrates to the *circle $n+1$ -group* $\mathbf{B}^n U(1)$. This is at the same time the higher *moduli stack* for circle n -bundles (also called $(n - 1)$ -bundle gerbes).

Recall then from the Introduction that a perturbative higher WZW model of dimension n is all encoded by a morphism of (super-) L_{∞} -algebras of the form

$$\mu : \mathfrak{g} \longrightarrow \mathbb{R}[n] .$$

Therefore, its non-perturbative refinement is to be an n -form connection on a circle n -bundle over the higher group G . The latter is given by a morphism of higher smooth (super-)groups the form

$$\Omega \mathbf{c} : G \longrightarrow \mathbf{B}^n U(1) .$$

(This is the higher and smooth analog of the canonical morphism $G \rightarrow K(\mathbb{Z}, 3)$ defining the fundamental class $[\omega_G] \in H^3(G; \mathbb{Z})$ for a compact, simple and simply connected Lie group G , in the traditional WZW model.) Equivalently, this is a morphism of the corresponding delooping stacks

$$\mathbf{c} : \mathbf{B}G \longrightarrow \mathbf{B}^{n+1}U(1) .$$

It is shown in [FSS10] that this always and canonically exists, it is just the Lie integration $\mathbf{c} = \exp(\mu)$ of the original L_∞ -cocycle.¹³

Now, as indicated in the Introduction, the local Lagrangian for the non-perturbative WZW model is to be an n -connection on this n -bundle whose curvature $n+1$ -form is $\mu(\theta_{\text{global}})$, the value of the original cocycle applied to a *globally defined* Maurer-Cartan form on G . Every higher group in cohesive geometry does carry a higher Maurer-Cartan form (see also [FRS13a]), given by a canonical map $\theta_G : G \rightarrow \mathfrak{b}_{\text{dR}}\mathbf{B}G$ with values in the (nonabelian) *de Rham hypercohomology* stack $\mathfrak{b}_{\text{dR}}\mathbf{B}G$. Exactly as $[\omega_G]$ for a Lie group is represented by the closed left-invariant 3-form $\omega_G = \mu(\theta_G \wedge \theta_G \wedge \theta_G)$, where θ_G is the Maurer-Cartan form of G , the morphism $\Omega \mathbf{c}$ has a canonical factorization

$$\begin{array}{ccc} G & \xrightarrow{\theta_G} & \mathfrak{b}_{\text{dR}}\mathbf{B}G & \xrightarrow{\mathfrak{b}_{\text{dR}}\mathbf{c}} & \mathfrak{b}_{\text{dR}}\mathbf{B}^{n+1}U(1) \\ & \searrow \Omega \mathbf{c} & & & \uparrow \text{curv} \\ & & & & \mathbf{B}^n U(1) , \end{array}$$

where $\mathfrak{b}_{\text{dR}}\mathbf{B}G$ and $\mathfrak{b}_{\text{dR}}\mathbf{B}^n U(1)$ are the higher smooth stacks of flat G -valued and of flat $\mathbf{B}^n U(1)$ -valued differential forms, respectively, θ_G is the Maurer-Cartan form, and $\text{curv} : \mathbf{B}^n U(1) \rightarrow \mathfrak{b}_{\text{dR}}\mathbf{B}^{n+1}U(1)$ is the canonical curvature morphism (see [FSS10, FRS13a] for details).

There is, however, a fundamental difference between the general case of a higher smooth group and the classical case of a compact Lie group. Namely, the higher Maurer-Cartan form $\theta_G : \mathbf{B}G \rightarrow \mathfrak{b}_{\text{dR}}\mathbf{B}G$ will not, in general, be represented by a globally defined flat differential form with coefficients in the L_∞ -algebra \mathfrak{g} . In other words, we do not have, in general, a factorization

$$\begin{array}{ccc} & & \Omega_{\text{flat}}^1(-; \mathfrak{g}) \\ & \nearrow \text{dotted} & \downarrow \\ G & \xrightarrow{\theta_G} & \mathfrak{b}_{\text{dR}}\mathbf{B}G \end{array}$$

as in the case of compact Lie groups. Rather, in general θ_G is a genuine hyper-cocycle: a collection of local differential forms on an atlas for G , with gauge transformations where their domain of definition overlaps and higher gauge transformations on higher intersections. The universal way to force a globally defined curvature form is to consider the smooth stack \tilde{G} which is the universal solution to the above factorization problem. That is, we consider the (higher) smooth stack \tilde{G} defined as the following homotopy pullback

$$\begin{array}{ccc} \tilde{G} & \xrightarrow{\theta_{\text{global}}} & \Omega_{\text{flat}}^1(-; \mathfrak{g}) \\ \downarrow \lrcorner & & \downarrow \\ G & \xrightarrow{\theta_G} & \mathfrak{b}_{\text{dR}}\mathbf{B}G \end{array}$$

¹³Here and in the following we use $U(1) = \mathbb{R}/\mathbb{Z}$ for brevity, but in general what appears is \mathbb{R}/Γ , for $\Gamma \hookrightarrow \mathbb{R}$ the discrete subgroup of *periods* of μ ; see [FSS10] for details.

in higher supergeometric smooth stacks. In conclusion then the non-perturbative WZW-model induced by the cocycle μ is to be an n -connection local Lagrangian of the form

$$\mathcal{L}_{\text{WZW}} : \tilde{G} \longrightarrow \mathbf{B}^n U(1)_{\text{conn}} ,$$

satisfying two conditions:

1. its curvature $(n + 1)$ -form is the evaluation of μ on the globally defined Maurer-Cartan form;
2. the underlying n -bundle is the higher group cocycle $\Omega \mathbf{c}$ given by Lie integration of μ .

The following proposition now asserts that this indeed exists canonically and is essentially uniquely.

Proposition 3.9.70. *On \tilde{G} there is an essentially unique factorization of the globally defined invariant form $\mu(\theta_{\text{global}})$ through an extended WZW action functional \mathcal{L}_{WZW}*

$$\begin{array}{ccc} \tilde{G} & \xrightarrow{\theta_{\text{global}}} & \Omega_{\text{flat}}(-, \mathfrak{g}) & \xrightarrow{\mu} & \Omega_{\text{cl}}^{n+1} \\ & \searrow \mathcal{L}_{\text{WZW}} & & \nearrow F_{(-)} & \\ & & \mathbf{B}^n U(1)_{\text{conn}} & & \end{array}$$

such that the underlying smooth class $G \rightarrow \mathbf{B}^n U(1)$ is the looping of the exponentiated cocycle $\mathbf{c} = \exp(\mu)$.

Proof. One considers the smooth stacks $\mathfrak{b}\mathbf{B}G$ and $\mathfrak{b}\mathbf{B}^{n+1}U(1)$ of G -principal bundles and $U(1)$ -principal $(n+1)$ -bundles with flat connections, respectively, together with the canonical morphisms $\mathfrak{b}_{\text{dR}}\mathbf{B}G \rightarrow \mathfrak{b}\mathbf{B}G$ and $\mathfrak{b}_{\text{dR}}\mathbf{B}^{n+1}U(1) \rightarrow \mathfrak{b}\mathbf{B}^{n+1}U(1)$ (again, see [FSS10, FRS13a] for definitions). By naturality of these morphisms one has a homotopy commutative diagram of the form

$$\begin{array}{ccc} \mathfrak{b}_{\text{dR}}\mathbf{B}G & \xrightarrow{\mathfrak{b}_{\text{dR}}\mathbf{c}} & \mathfrak{b}_{\text{dR}}\mathbf{B}^{n+1}U(1) \\ \downarrow & & \downarrow \\ \mathfrak{b}\mathbf{B}G & \xrightarrow{\mathbf{c}} & \mathbf{B}^{n+1}U(1) . \end{array}$$

Then, by naturality of the inclusions $\Omega_{\text{flat}}^1(-; \mathfrak{g}) \rightarrow \mathfrak{b}_{\text{dR}}\mathbf{B}G$ and $\Omega_{\text{cl}}^{n+1} = \Omega_{\text{flat}}^1(-; \mathbb{R}[n]) \rightarrow \mathfrak{b}_{\text{dR}}\mathbf{B}^{n+1}U(1)$, one has a homotopy commutative diagram

$$\begin{array}{ccc} \Omega_{\text{flat}}^1(-; \mathfrak{g}) & \xrightarrow{\mu} & \Omega_{\text{cl}}^{n+1} \\ \downarrow & & \downarrow \\ \mathfrak{b}_{\text{dR}}\mathbf{B}G & \xrightarrow{\mathfrak{b}_{\text{dR}}\mathbf{c}} & \mathfrak{b}_{\text{dR}}\mathbf{B}^{n+1}U(1) . \end{array}$$

Finally, since by definition $\mathfrak{b}_{\text{dR}}\mathbf{B}G$ is the homotopy fiber of the forgetful morphism $\mathfrak{b}\mathbf{B}G \rightarrow \mathbf{B}G$, we have a homotopy pullback diagram of the form

$$\begin{array}{ccc} G \simeq \Omega \mathbf{B}G & \longrightarrow & \mathfrak{b}_{\text{dR}}\mathbf{B}G \\ \downarrow & & \downarrow \\ * & \longrightarrow & \mathfrak{b}\mathbf{B}G . \end{array}$$

Pasting together the above three diagrams and the homotopy commutative diagram defining \tilde{G} we obtain the big homotopy commutative diagram

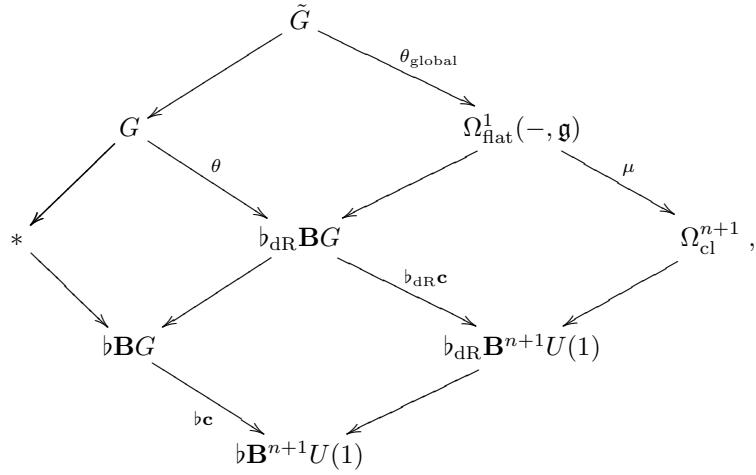

and hence the homotopy commutative diagram

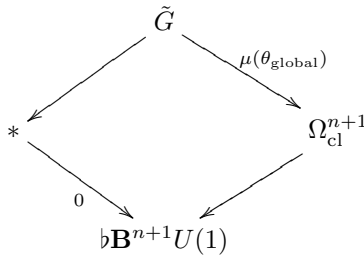

as the outermost part of the above big diagram. Then, by the universal property of the homotopy pullback, this factors essentially uniquely as

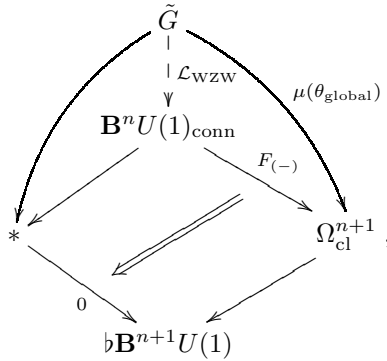

where we have used the fact that the stack $\mathbf{B}^n U(1)_{\text{conn}}$ of $U(1)$ - n -bundles with connection is naturally the homotopy fiber of the inclusion $\Omega_{\text{cl}}^{n+1} \rightarrow b\mathbf{B}^{n+1}U(1)$; see [FSS10]. \square

Remark 3.9.71. The above proposition has been stated having in mind a cocycle with integral periods, so that $\mathbb{R}/\mathbb{Z} \cong U(1)$. The generalization to an arbitrary subgroup of periods $\Gamma \hookrightarrow \mathbb{R}$ is immediate.

Remark 3.9.72. The construction of the full higher WZW term \mathcal{L}_{WZW} in Prop. 3.9.70 turns out to canonically exhibit the higher WZW-type theory as the boundary theory of a higher Chern-Simons-type theory, in the precise sense of Def. Prop. 5.6.13. To see this, first recall that an $(n + 1)$ -dimensional local Chern-Simons-type prequantum field theory for a cocycle $\mathbf{c} : \mathbf{B}G \rightarrow \mathbf{B}^{n+1}U(1)$ as above is a map of smooth higher moduli stacks of the form

$$\mathcal{L}_{\text{CS}} : \mathbf{B}G_{\text{conn}} \rightarrow \mathbf{B}^{n+1}U(1)_{\text{conn}}$$

which fits into a homotopy commutative diagram of the form

$$\begin{array}{ccc} \mathfrak{b}\mathbf{B}G & \xrightarrow{\mathfrak{b}\mathbf{c}} & \mathfrak{b}\mathbf{B}^{n+1}U(1) \\ \downarrow & & \downarrow \\ \mathbf{B}G_{\text{conn}} & \xrightarrow{\mathcal{L}_{\text{CS}}} & \mathbf{B}^{n+1}U(1)_{\text{conn}} \\ \downarrow & & \downarrow \\ \mathbf{B}G & \xrightarrow{\mathbf{c}} & \mathbf{B}^{n+1}U(1) . \end{array}$$

This hence is a refinement to differential cohomology that respects both the inclusion of flat higher connections as well as the underlying universal principal n -bundles. In [FSS10] is given a general construction of such \mathcal{L}_{CS} by a stacky/higher version of Chern-Weil theory, which applies whenever the cocycle μ is in transgression with an invariant polynomial on the L_∞ -algebra \mathfrak{g} . For instance ordinary 3d Chern-Simons theory is induced this way from the transgressive 3-cocycle $\langle -, [-, -] \rangle$ on a semisimple Lie algebra, and the nonabelian 7d Chern-Simons theory on String 2-connections which appears in quantum corrected 11d supergravity is induced by the corresponding 7-cocycle [FSS12b].

Now by pasting this diagram below the diagram

$$\begin{array}{ccccc} \tilde{G} & \xrightarrow{\theta_{\text{global}}} & \Omega_{\text{flat}}^1(-, \mathfrak{g}) & \xrightarrow{\mu} & \Omega_{\text{cl}}^{n+1} \\ \downarrow \lrcorner & & \downarrow & & \downarrow \\ G & \xrightarrow{\theta_G} & \mathfrak{b}_{\text{dR}}\mathbf{B}G & \xrightarrow{\mathfrak{b}_{\text{dR}}\mathbf{c}} & \mathfrak{b}_{\text{dR}}\mathbf{B}^{n+1}U(1) \end{array}$$

appearing in the proof of Prop. 3.9.70 we obtain the homotopy commutative diagram of smooth higher moduli stacks

$$\begin{array}{ccccc} \tilde{G} & \xrightarrow{\theta_{\text{global}}} & \Omega_{\text{flat}}^1(-, \mathfrak{g}) & \xrightarrow{\mu} & \Omega_{\text{cl}}^{n+1} \\ \downarrow \lrcorner & & \downarrow & & \downarrow \\ G & \xrightarrow{\theta_G} & \mathfrak{b}_{\text{dR}}\mathbf{B}G & \xrightarrow{\mathfrak{b}_{\text{dR}}\mathbf{c}} & \mathfrak{b}_{\text{dR}}\mathbf{B}^{n+1}U(1) \\ \downarrow \lrcorner & & \downarrow & & \downarrow \\ * & \longrightarrow & \mathfrak{b}\mathbf{B}G & \xrightarrow{\mathfrak{b}\mathbf{c}} & \mathfrak{b}\mathbf{B}^{n+1}U(1) \\ \downarrow \lrcorner & & \downarrow & & \downarrow \\ * & \longrightarrow & \mathbf{B}G_{\text{conn}} & \xrightarrow{\mathcal{L}_{\text{CS}}} & \mathbf{B}^{n+1}U(1)_{\text{conn}} . \end{array}$$

Remark 3.9.73. Inside the above diagram one reads the correspondence

$$\begin{array}{ccc}
 & \tilde{G} & \\
 & \swarrow & \searrow \theta_{\text{global}} \\
 * & & \mathbf{B}G_{\text{conn}} \\
 & \swarrow \mathcal{L}_{\text{WZW}} & \swarrow \mathcal{L}_{\text{CS}} \\
 & 0 & \\
 & \searrow & \\
 & \mathbf{B}^{n+1}U(1)_{\text{conn}} &
 \end{array}$$

which equivalently expresses the higher WZW term as a cocycle in degree n differential cohomology twisted by the Chern-Simons term evaluated on the globally defined Maurer-Cartan form. According to definition 5.6.13 this precisely exhibits \mathcal{L}_{WZW} as a boundary condition for \mathcal{L}_{CS} .

This general mathematical statement seems to be well in line with the relation between higher Chern-Simons terms and higher WZW models found in [Wi97b]. Notice that with \mathcal{L}_{WZW} realized as a boundary theory of \mathcal{L}_{CS} this way, any further boundary of \mathcal{L}_{WZW} , notably as in Def. 5.6.14, makes that a *corner* of \mathcal{L}_{CS} . In fact, in [Sc13b] is shown that \mathcal{L}_{CS} itself is already naturally a boundary theory for a topological field theory of yet one dimension more, namely a universal higher topological Yang-Mills theory. Hence we find here a whole cascade of *corner field theories* of arbitrary codimension. For instance from the results above we have the sequence of higher order corner theories that looks like

$$\text{M2-brane} \xleftarrow{\text{ends on}} \text{M5-brane} \xleftarrow{\text{WZW boundary of}} \text{7d CS in 11d Suga} \xleftarrow{\text{boundary of}} \text{8d tYM} .$$

Such hierarchies of higher order corner field theories have previously been recognized and amplified in string theory and M-theory [Sa11a, Sa12]. More discussion of the above formalization of these hierarchies in local (multi-tiered) prequantum field theory is in [Sc13b]. Closely related considerations have appeared in [Fr12b].

To further appreciate the abstract construction of the higher WZW term \mathcal{L}_{WZW} in Prop. 3.9.70, it is helpful to notice the following two basic examples, which are in a way at opposites ends of the space of all examples.

Example 3.9.74. For \mathfrak{g} an ordinary (super-)Lie algebra and G an ordinary (super-)Lie group integrating it, we have $\mathfrak{b}_{\text{dR}}\mathbf{B}G \simeq \Omega_{\text{flat}}^1(-, \mathfrak{g})$. This implies that in this case $\tilde{G} \simeq G$, hence that there is no extra “differential extension”. Now for μ a 3-cocycle, the induced \mathcal{L}_{WZW} is the traditional WZW term, refined to a Deligne 2-cocycle/bundle gerbe with connection as in [Ga88, FrWi99].

Example 3.9.75. For $\mathfrak{g} = \mathbb{R}[n]$ we can take the smooth higher group integrating it to be the $(n+1)$ -group $G = \mathbf{B}^n U(1)$. In this case the definition of \tilde{G} is precisely the characterization of the moduli n -stack of $U(1)$ - n -bundles with connections, by def. 4.4.85, so that

$$\tilde{G} \simeq \mathbf{B}^n U(1)_{\text{conn}}$$

in this case. Then for $\mu : \mathfrak{g} \rightarrow \mathbb{R}[n]$ the canonical cocycle (the identity), it follows that \mathcal{L}_{WZW} is the identity, hence is the canonical $U(1)$ - n -connection on the moduli n -stack of all $U(1)$ - n -connections. This describes the extreme case of a higher WZW-type field theory with *no* σ -model fields and *only* a “tensor field” on its worldvolume, and whose action functional is simply the higher volume holonomy of that higher gauge field.

Generic examples of higher WZW theories are twisted products of the above two basic examples:

Example 3.9.76. Consider K a higher (super-)group extension of a Lie (super-)group G of the form

$$\mathbf{B}^n U(1) \longrightarrow K \longrightarrow G .$$

For instance G may be a translation super-group $\mathbb{R}^{d;N}$ and K the Lie integration of one of the extended superspaces such as **m2brane** considered above (spacetime filled with a brane condensate, Remark 5.6.23). This means that K is a *twisted product* of the (super-)Lie group G and the $(n + 1)$ -group $\mathbf{B}^n U(1)$, which appear in examples 3.9.74 and 3.9.75 above. Since the construction of \mathcal{L}_{WZW} in the proof of Prop. 3.9.70 suitably respects products, it follows that the field content of a higher WZW model on the higher smooth (super-)group K is a tuple consisting of

1. a σ -model field with values in G ;
2. an n -form higher gauge field,

both subject to a twisting condition which gives the higher gauge field a twisted Bianchi identity depending on the σ -model fields.

In particular, for the extended spacetime given by an M2-brane condensate in 11-dimensional ($N = 1$)-super spacetime, this says that the M5-brane higher WZW model according to Section 5.6.4.4 has fields given by a multiplet consisting of embedding fields into spacetime and a 2-form higher gauge field (“tensor field”) on its worldvolume. Notice that the higher gauge transformations of the 2-form field are correctly taken into account by this full (in particular non-perturbative) construction of the WZW term as a higher prequantum bundle.

3.9.13 Prequantum geometry

Traditional *prequantum geometry* (see for instance [EMRV98] for a standard account) is the differential geometry of smooth manifolds which are “twisted” by circle-principal bundles and circle-principal connections – thought of as “prequantum bundles” – or equivalently is the *contact geometry* [Et03] of the total spaces of these bundles thought of as *regular contact manifolds* [BoWa58]. Prequantum geometry studies the automorphisms of prequantum bundles covering diffeomorphisms of the base – the *prequantum operators* – and the action of these on the space of sections of the associated line bundle – the *prequantum states*. This is an intermediate step in the genuine *geometric quantization* of the curvature 2-form of these bundles, which is obtained by dividing the above data in half, important for instance in the *orbit method*. But prequantum geometry is of interest already in its own right. For instance the above automorphism group naturally provides the Lie integration of the *Poisson Lie algebra* of the underlying symplectic manifold. Moreover, it is canonically included into the group of bisections of the Lie integration of the Atiyah Lie algebroid of the given circle bundle.

We now formulate *geometric prequantum theory* internally to any cohesive ∞ -topos to obtain *higher prequantum geometry*.

This section draws from [FRS13a].

- 3.9.13.1 – Introduction and Survey
- 3.9.13.2 – Prequantization;
- 3.9.13.3 – Symplectomorphism group;
- 3.9.13.4 – Contactomorphism group;
- 3.9.13.5 – Qantomorphism group and Heisenberg group;
- 3.9.13.6 – Courant Lie algebroid;
- 3.9.13.8 – Prequantum states;
- 3.9.13.9 – Prequantum operators.

3.9.13.1 Introduction and survey Traditional prequantum geometry is the differential geometry of smooth manifolds which are equipped with a twist in the form of a $U(1)$ -principal bundle with a $U(1)$ -principal connection. (See section II of [Br93] for a modern account.) In the context of geometric quantization [Sou97] of symplectic manifolds these arise as *prequantizations* (whence the name): lifts of the symplectic form from de Rham cocycles to differential cohomology. Equivalently, prequantum geometry is the *contact geometry* of the total spaces of these bundles, equipped with their Ehresmann connection 1-form [BoWa58]. Prequantum geometry studies the automorphisms of prequantum bundles covering diffeomorphisms of the base – the prequantum operators or contactomorphisms – and the action of these on the space of sections of the associated line bundle – the prequantum states. This is an intermediate step in the genuine geometric quantization of symplectic manifolds, which is obtained by “dividing the above data in half” by a choice of polarization. While polarizations do play central role in geometric quantum theory, for instance in the orbit method in geometric representation theory [Kir04], to name just one example, geometric prequantum theory is of interest in its own right. For instance the quantomorphism group naturally provides a non-simply connected Lie integration of the Poisson bracket Lie algebra of the underlying symplectic manifold and the pullback of this extension along Hamiltonian actions induces central extensions of infinite-dimensional Lie groups (see for instance [RaSch81, Vi11]). Moreover, the quantomorphism group comes equipped with a canonical injection into the group of bisections of the groupoid which integrates the Atiyah Lie algebroid associated with the given principal bundle (this we discuss below in 3.9.13.6). These are fundamental objects in the study of principal bundles over manifolds.

We observe now that all this has a simple natural reformulation in terms of the maps into the smooth moduli stacks that classify – better: modulate – principal bundles and principal connections. This reformulation exhibits an abstract characterization of prequantum geometry which immediately generalizes to higher geometric contexts richer than traditional differential geometry.

To start with, if we write Ω_{cl}^2 for the sheaf of smooth closed differential 2-forms (on the site of all smooth manifolds), then by the Yoneda lemma a closed (for instance symplectic) 2-form ω on a smooth manifold X is equivalently a map of sheaves $\omega : X \longrightarrow \Omega_{\text{cl}}^2$. It is useful to think of this as a simple first instance of moduli stacks: Ω_{cl}^2 is the universal moduli stack of smooth closed 2-forms.

Similarly but more interestingly, there is a smooth moduli stack of circle-principal connections, def. 4.4.85. This we denote by $\mathbf{BU}(1)_{\text{conn}}$ in order to indicate that it is a differential refinement of the universal moduli stack $\mathbf{BU}(1)$ of just $U(1)$ -principal connections, which in turn is a smooth refinement of the traditional classifying space $BU(1) \simeq K(\mathbb{Z}, 2)$ of just equivalence classes of such bundles. Hence $\mathbf{BU}(1)_{\text{conn}}$ is the “smooth homotopy 1-type” which is uniquely characterized by the fact that maps $X \rightarrow \mathbf{BU}(1)_{\text{conn}}$ from a smooth manifold X are equivalently circle-principal connections on X , and that homotopies between such maps are equivalently smooth gauge transformations between such connections. This is a refinement of Ω_{cl}^2 : the map which sends a circle-principal connection to its curvature 2-form constitutes a map of universal moduli stacks $F_{(-)} : \mathbf{BU}(1)_{\text{conn}} \longrightarrow \Omega_{\text{cl}}^2$, hence a universal invariant 2-form on $\mathbf{BU}(1)_{\text{conn}}$. This universal curvature form characterizes traditional prequantization: for $\omega \in \Omega_{\text{cl}}^2(X)$ a (pre-)symplectic form as above, a *prequantization* of (X, ω) is equivalently a lift ∇ in the diagram

$$\begin{array}{ccc} X & \overset{\nabla}{\dashrightarrow} & \mathbf{BU}(1)_{\text{conn}} \\ \omega \searrow & & \swarrow F_{(-)} \\ & \Omega_{\text{cl}}^2 & \end{array} ,$$

where the commutativity of the diagram expresses the traditional prequantization condition $\omega = F_{\nabla}$.

A triangular diagram as above may naturally be interpreted as exhibiting a map *from* ω *to* $F_{(-)}$ *in the slice topos over* Ω_{cl}^2 . This means that the map $F_{(-)}$ is itself a universal moduli stack – the universal moduli stack of prequantizations. As such, $F_{(-)}$ lives not in the topos over all smooth manifolds, but in its slice over Ω_{cl}^2 , which is the topos of smooth stacks equipped with a map into Ω_{cl}^2 .

Now given a prequantization ∇ , then a *quantomorphism* or *integrated prequantum operator* is traditionally defined to be a pair (ϕ, η) , consisting of a diffeomorphism $\phi : X \xrightarrow{\cong} X$ together with an equivalence of prequantum connections $\eta : \phi^*\nabla \xrightarrow{\cong} \nabla$. A moment of reflection shows that such a pair is equivalently again a triangular diagram, now as on the right of

$$\mathbf{QuantMorph}(\nabla) = \left\{ \begin{array}{l} \phi \in \text{Diff}(X), \\ \eta : \phi^*\nabla \xrightarrow{\cong} \nabla \end{array} \right\} \simeq \left\{ \begin{array}{ccc} X & \xrightarrow{\phi} & X \\ & \swarrow \eta & \searrow \nabla \\ & \mathbf{BU}(1)_{\text{conn}} & \end{array} \right\}.$$

This also makes the group structure on these pairs manifest – the *quantomorphism group*: it is given by the evident pasting of triangular diagrams. In this form, the quantomorphism group is realized as an example of a very general construction that directly makes sense also in higher geometry: it is the automorphism group of a modulating morphism regarded as an object in the slice topos over the corresponding moduli stack – a relative automorphism group. Also in this form the central property of the quantomorphism group – the fact that over a connected manifold it is a $U(1)$ -extension of the group of Hamiltonian symplectomorphisms – is revealed to be just a special case of a very general extension phenomenon, expressed by the schematic diagrams below:

$$U(1) \quad \rightarrow \quad \mathbf{QuantMorph}(\nabla) \quad \rightarrow \quad \mathbf{HamSympl}(\nabla)$$

$$\left\{ \begin{array}{c} X \\ \nabla \left(\leftarrow \right) \nabla \\ \mathbf{BU}(1)_{\text{conn}} \end{array} \right\} \rightarrow \left\{ \begin{array}{ccc} X & \xrightarrow{\cong} & X \\ & \swarrow \eta & \searrow \nabla \\ & \mathbf{BU}(1)_{\text{conn}} & \end{array} \right\} \rightarrow \left\{ X \xrightarrow{\cong} X \right\}.$$

Our main theorems in 3.9.13.5 below are a general account of canonical extensions induced by (higher) automorphism groups in slices over (higher, differential) moduli stacks in this fashion.

This $U(1)$ -extension is the hallmark of quantization: under Lie differentiation the above sequence of (infinite-dimensional) Lie groups turns into the extension of Lie algebras

$$i\mathbb{R} \rightarrow \mathfrak{Poisson}(X, \omega) \rightarrow \mathfrak{X}_{\text{Ham}}(X, \omega)$$

that exhibits the Poisson bracket Lie algebra of the symplectic manifold as an $i\mathbb{R} \simeq \text{Lie}(U(1))$ -extension of the Lie algebra of Hamiltonian vector fields on X – the *Kostant-Souriau extension* (e.g section 2.3 of [Br93]). If we write $\hbar \in \mathbb{R}$ for the canonical basis element (“Planck’s constant”) then this expresses the quantum deformation of “classical commutators” in $\mathfrak{X}_{\text{Ham}}(X, \omega)$ by the central term $i\hbar$.

More widely known than the quantomorphism groups of all prequantum operators are a class of small subgroups of them, the *Heisenberg groups* of translational prequantum operators: if (X, ω) is a symplectic vector space of dimension $2n$, regarded as a symplectic manifold, then the translation group \mathbb{R}^{2n} canonically acts on it by Hamiltonian symplectomorphisms, hence by a group homomorphism $\mathbb{R}^{2n} \rightarrow \mathbf{HamSympl}(\nabla)$. The pullback of the above quantomorphism group extension along this map yields a $U(1)$ -extension of \mathbb{R}^{2n} , and this is the traditional Heisenberg group $H(n, \mathbb{R})$. More generally, for (X, ω) any (prequantized) symplectic manifold and G any Lie group, one considers *Hamiltonian G -actions*: smooth group homomorphisms $\phi : G \rightarrow \mathbf{HamSympl}(\nabla)$. Pulling back the quantomorphism group extension now yields a $U(1)$ -extension of G and this we may call, more generally, the Heisenberg group extension induced by the Hamiltonian G -action:

$$U(1) \rightarrow \mathbf{Heis}_\phi(\nabla) \rightarrow G.$$

The crucial property of the quantomorphism group and any of its Heisenberg subgroups, at least for the purposes of geometric quantization, is that these are canonically equipped with an action on the space of

prequantum states (the space of sections of the complex line bundle which is associated to the prequantum bundle), this is the action of the *exponentiated prequantum operators*. Under an *integrated moment map*, – a group homomorphism $G \rightarrow \mathbf{QuantMorph}(\nabla)$ covering a Hamiltonian G -action – this induces a representation of G on the space of prequantum states. After a choice of polarization this is the construction that makes geometric quantization a valuable tool in geometric representation theory.

This action of prequantum operators on prequantum states is naturally interpreted in terms of slicing, too: A prequantum operator is traditionally defined to be a function $H \in C^\infty(X)$ with action on prequantum states ψ traditionally given by the formula

$$O_H : \psi \mapsto i\nabla_{v_H}\psi + H \cdot \psi,$$

where the first term is the covariant derivative of the prequantum connection along the Hamiltonian vector field corresponding to H . To see how this formula together with its Lie integration, falls out naturally from the perspective of the slice over the moduli stack, write $\mathbb{C} // U(1)$ for the quotient stack of the canonical 1-dimensional complex representation of the circle group, and observe that this comes equipped with a canonical map $\rho : \mathbb{C} // U(1) \longrightarrow * // U(1) \simeq \mathbf{BU}(1)$ to the moduli stack of circle-principal bundles. This is the universal complex line bundle over the moduli stack of $U(1)$ -principal bundles, and it has a differential refinement compatible with that of its base stack to a map $\rho_{\text{conn}} : \mathbb{C} // U(1)_{\text{conn}} \longrightarrow \mathbf{BU}(1)_{\text{conn}}$. Now one can work out that maps $\psi : \nabla \rightarrow \rho_{\text{conn}}$ in the slice over $\mathbf{BU}(1)_{\text{conn}}$ are equivalently sections of the complex line bundle $P \times_{U(1)} \mathbb{C}$ which is ρ -associated to the $U(1)$ -principal prequantum bundle:

$$\Gamma_X (P \times_{U(1)} \mathbb{C}) \simeq \left\{ \begin{array}{ccc} X & \xrightarrow{\psi} & \mathbb{C} // U(1) \\ & \swarrow \nabla & \searrow \rho_{\text{conn}} \\ & & \mathbf{BU}(1)_{\text{conn}} \end{array} \right\}.$$

With this identification, the action of quantomorphisms on prequantum states

$$(O_h, \psi) \mapsto O_h(\psi)$$

is simply the precomposition action in the slice $\mathbf{H}/_{\mathbf{BU}(1)}$, hence the action by pasting of triangular diagrams in \mathbf{H} :

$$\left(\begin{array}{ccc} X & \xrightarrow{\phi} & X \\ & \swarrow \nabla & \searrow \nabla \\ & & \mathbf{BU}(1)_{\text{conn}} \end{array} \quad , \quad \begin{array}{ccc} X & \xrightarrow{\psi} & \mathbb{C} // U(1)_{\text{conn}} \\ & \swarrow \nabla & \searrow \rho_{\text{conn}} \\ & & \mathbf{BU}(1)_{\text{conn}} \end{array} \right) \mapsto \begin{array}{ccc} X & \xrightarrow{\phi} & X & \xrightarrow{\psi} & \mathbb{C} // U(1)_{\text{conn}} \\ & \swarrow \nabla & \downarrow & \swarrow \nabla & \searrow \rho_{\text{conn}} \\ & & \mathbf{BU}(1)_{\text{conn}} & & \end{array}$$

Once formulated this way as the geometry of stacks in the higher slice toposes over the smooth moduli stack of principal connections, it is clear that there is a natural generalization of traditional prequantum geometry, hence of regular contact geometry, obtained by interpreting these diagrams in higher differential geometry with smooth moduli stacks of principal bundles and principal connections refined to higher smooth moduli stacks. Moreover, by carefully abstracting the minimum number of axioms on the ambient toposes actually needed in order to express the relevant constructions (this we discuss in 3.9.13) one obtains generalizations to various other flavors of higher/derived geometry, such as higher/derived supergeometry.

Just as traditional prequantum geometry and contact geometry is of interest in itself, this natural refinement to higher geometry is of interest in itself, and is one motivation for studying higher prequantum geometry. For instance in 5.4 we indicate how various higher central extensions of interest in string geometry can be constructed as higher Heisenberg-group extensions in higher prequantum geometry.

But the strongest motivation for studying traditional prequantum geometry is, as the name indicates, as a means in quantum mechanics and quantum field theory. This we come to below in 6.

∞ -geometric quantization	cohesive homotopy type theory	twisted hyper-sheaf cohomology
pre- n -plectic cohesive ∞ -groupoid	$\omega : X \rightarrow \Omega_{\text{cl}}^2(-, \mathbb{G})$ (e.g. $\mathbb{G} = \mathbf{B}^{n-1}U(1)$ or $= \mathbf{B}^{n-1}\mathbb{C}^\times$)	twisting cocycle in de Rham cohomology
symplectomorphisms	$\mathbf{Aut}_{\mathbf{H}}(\omega) = \left\{ \begin{array}{ccc} X & \xrightarrow{\simeq} & X \\ & \searrow \omega & \swarrow \omega \\ & \Omega_{\text{cl}}^2(-, \mathbb{G}) & \end{array} \right\}$	twist automorphism ∞ -group
prequantum bundle	$\begin{array}{ccc} & \mathbf{B}\mathbb{G}_{\text{conn}} & \\ \nabla \nearrow & & \downarrow F_{(-)} \\ X & \xrightarrow{\omega} & \Omega_{\text{cl}}^2(-, \mathbb{G}) \end{array}$	twisting cocycle in differential cohomology
Planck's constant \hbar	$\frac{1}{\hbar}\nabla : X \rightarrow \mathbf{B}^n\mathbb{G}_{\text{conn}}$	divisibility of twist class
quantomorphism group \supset Heisenberg group	$\mathbf{Aut}_{\mathbf{H}}(\nabla) = \left\{ \begin{array}{ccc} X & \xrightarrow{\simeq} & X \\ & \swarrow \nabla & \searrow \nabla \\ & \mathbf{B}^n\mathbb{G}_{\text{conn}} & \end{array} \right\}$	twist automorphism ∞ -group
Hamiltonian G -action	$\mu : \mathbf{B}G \rightarrow \mathbf{Aut}_{\mathbf{H}}(\nabla)$	G - ∞ -action on the twisting cocycle
gauge reduction	$\nabla // G : X // G \rightarrow \mathbf{B}\mathbb{G}_{\text{conn}}$	G - ∞ -quotient of the twisting cocycle
Hamiltonian observables with Poisson bracket	$\text{Lie}(\mathbf{Aut}_{\mathbf{H}}(\nabla))$	infinitesimal twist automorphisms
Hamiltonian symplectomorphisms	$\text{image} \left(\mathbf{Aut}_{\mathbf{H}}(\nabla) \longrightarrow \mathbf{Aut}(X) \right)$	twists in de Rham cohomology that lift to differential cohomology
\mathbb{G} -representation	$\begin{array}{ccc} V & \longrightarrow & V // \mathbb{G} \\ & & \downarrow \rho \\ & & \mathbf{B}\mathbb{G} \end{array}$	local coefficient ∞ -bundle
prequantum space of states	$\Gamma_X(E) = \left\{ \begin{array}{ccc} X & \xrightarrow{\sigma} & V // \mathbb{G} \\ & \swarrow \simeq & \searrow \rho \\ & \mathbf{B}\mathbb{G} & \end{array} \right\}$	cocycles in [\mathbf{c}]-twisted cohomology
prequantum operator action	$\widehat{(-)} : \Gamma_X(E) \times \mathbf{Aut}_{\mathbf{H}} \rightarrow \Gamma_X(E)$	∞ -action of twist automorphisms on twisted cocycles
transgression	composition with: $\begin{array}{ccc} [S^1, V // \mathbb{G}_{\text{conn}}] & \xrightarrow{\text{tr hol}_{S^1}} & V // \Omega\mathbb{G}_{\text{conn}} \\ \downarrow \rho_{\text{conn}}^V & & \downarrow \rho_{\text{conn}}^V \\ \mathbf{B}\mathbb{G}_{\text{conn}} & \xrightarrow{\exp(2\pi i \int_{S^1} (-))} & \mathbb{G}_{\text{conn}} \end{array}$	fiber integration in (nonabelian) differential cohomology

3.9.13.2 Prequantization Let $X \in \mathbf{H}$ be a cohesive homotopy type. Let $\mathbb{G} \in \text{Grp}(\mathbf{H})$ be a braided cohesive group, def. 3.6.116. In the present context we say

Definition 3.9.77. 1. A morphism (def. 3.9.34)

$$\omega : X \longrightarrow \Omega_{\text{cl}}^2(-, \mathbb{G})$$

is a *pre-symplectic structure* on X .

2. Given a pre-symplectic structure, a lift ∇ in

$$\begin{array}{ccc} & & \mathbf{B}\mathbb{G}_{\text{conn}} \\ & \nearrow \nabla & \downarrow F_{(-)} \\ X & \xrightarrow{\omega} & \Omega_{\text{cl}}^2(-, \mathbb{G}) \end{array}$$

is a *prequantization* of (X, ω) .

3.9.13.3 Symplectomorphisms Let $X \in \mathbf{H}$ be a cohesive homotopy type. Let $\mathbb{G} \in \text{Grp}(\mathbf{H})$ be a braided cohesive group, def. 3.6.116. Let

$$\omega : X \longrightarrow \Omega_{\text{cl}}^2(-, \mathbb{G}) .$$

be a pre-symplectic structure, def. 3.9.34.

Definition 3.9.78. The *symplectomorphism group* $\mathbf{Sympl}(\omega)$ of the pre-symplectic geometry (X, ω) is the \mathbf{H} -valued automorphism group, def. 3.6.11, of $\omega \in \mathbf{H}/\Omega_{\text{cl}}^2(-, \mathbb{G})$:

$$\mathbf{Sympl}(\omega) := \mathbf{Aut}_{\mathbf{H}}(\omega) := \prod_{\Omega_{\text{cl}}^2(-, \mathbb{G})} \mathbf{Aut}(\omega) .$$

Remark 3.9.79. According to remark 3.6.7 a global element of $\mathbf{Sympl}(\omega)$ corresponds to a diagram in \mathbf{H} of the form

$$\begin{array}{ccc} X & \xrightarrow[\simeq]{\phi} & X \\ & \searrow \omega & \swarrow \omega \\ & \Omega_{\text{cl}}^2(-, \mathbb{G}) & \end{array} .$$

This is a diffeomorphism ϕ of X which preserves the pre-symplectic structure in that

$$\phi^* \omega = \omega .$$

Definition 3.9.80. Write

$$p_{\Omega_{\text{cl}}^2(-, \mathbb{G})} : \mathbf{Sympl}(\omega) \longrightarrow \mathbf{Aut}(X)$$

for the canonical morphism induced by restriction of the morphism of prop. 3.6.9.

Proposition 3.9.81. *The morphism $p_{\Omega_{\text{cl}}^2(-, \mathbb{G})}$ of def. 3.9.80 is a monomorphism*

Proof. By direct generalization of the proof of prop. 3.6.16 we find that for each $U \in \mathbf{H}$ the fibers of $p_{\Omega_{\text{cl}}^2(-, \mathbb{G})}$ are path space objects of $[X, \Omega_{\text{cl}}^2(-, \mathbb{G})]$. But since $\Omega_{\text{cl}}^2(-, \mathbb{G})$ is 0-truncated by def. 3.9.34, also $[X, \Omega_{\text{cl}}^2(-, \mathbb{G})]$ is 0-truncated, and so its path spaces are either contractible or empty. \square

3.9.13.4 Contactomorphisms

Definition 3.9.82. Given two \mathbb{G} -principal connections $\nabla_1 : X_1 \rightarrow \mathbf{B}\mathbb{G}_{\text{conn}}$ and $\nabla_2 : X_2 \rightarrow \mathbf{B}\mathbb{G}_{\text{conn}}$, a (strict) *contactomorphism between regular contact spaces* from ∇_1 to ∇_2 is a morphism between them in the slice $\mathbf{H}/_{\mathbf{B}\mathbb{G}_{\text{conn}}}$. The ∞ -groupoid of contactomorphisms between ∇_1 and ∇_2 is

$$\text{ContactMorph}(\nabla_1, \nabla_2) := \Gamma([\nabla_1, \nabla_2]_{\mathbf{H}}) := \Gamma \prod_{\mathbf{B}\mathbb{G}_{\text{conn}}} [\nabla_1, \nabla_2],$$

Remark 3.9.83. This means that a single contactomorphism from ∇_1 to ∇_2 is given by a diagram

$$\begin{array}{ccc} X & \xrightarrow{\quad \simeq \quad} & X \\ & \swarrow \nabla_1 & \searrow \nabla_2 \\ & \mathbf{B}\mathbb{G}_{\text{conn}} & \end{array}$$

in \mathbf{H} . However, in order to obtain the correct cohesive structure on the collection of all contactomorphisms we need to *concretify* the object $[\nabla_1, \nabla_2]_{\mathbf{H}}$, as in the discussion at 3.9.6.4.

3.9.13.5 Quantomorphism group and Heisenberg group Famously, quantum theory is governed by the appearance of a group of quantum observables/operators called a *Heisenberg group*. But in fact the Heisenberg group is but the subgroup on *linear* translations in phase space of the full group of prequantum operators. In standard textbooks on geometric quantization the latter is called the *quantomorphism group*. While standard in geometric quantization, that term is rather less wide-spread in the physics literature. Many physics textbooks know the quantomorphism group, if at all, just as *the Fréchet-Lie group which integrates the Poisson bracket*.

Here we take the opposite perspective: we give a general abstract formalization of quantomorphism ∞ -groups in a cohesive ∞ -topos. We work out concrete differential-geometric incarnations of this in the context of smooth cohesion in section 4.4.20 Then, further below in section 3.9.13.7, we *define* the *Poisson ∞ -Lie algebra* to be the ∞ -Lie algebra of the quantomorphism ∞ -group. Our main result below says that this reduces in the appropriate special cases not only to the traditional Poisson bracket Lie algebra in symplectic geometry, but also to the Poisson Lie- n -algebras of n -plectic geometry.

Let \mathbf{H} be a cohesive ∞ -topos (such as that of smooth ∞ -groupoids), let $\mathbb{G} \in \text{Grp}_2(\mathbf{H})$ be a braided ∞ -group in \mathbf{H} , let $\mathbf{B}\mathbb{G}_{\text{conn}}$ be the universal moduli ∞ -stack of \mathbb{G} -principal connections.

Definition 3.9.84. For $\nabla : X \rightarrow \mathbf{B}\mathbb{G}_{\text{conn}}$ the map modulating a \mathbb{G} -principal connection, the corresponding *higher quantomorphism groupoid* $\text{At}(\nabla)_\bullet \in \text{Grpd}(\mathbf{H})$ or *higher contactomorphism groupoid* induced by ∇ is the corresponding higher Atiyah-groupoid, hence under the equivalence of prop. 3.6.87 is the ∞ -groupoid with atlas which is the 1-image projection

$$X \twoheadrightarrow \text{At}(\nabla) := \text{im}_1(\nabla)$$

of ∇ .

Remark 3.9.85. The unconcretified ∞ -group of bisections of the higher quantomorphism groupoid $\text{At}(\nabla)_\bullet$ of def. 3.9.84 sits in a homotopy fiber sequence of the form

$$\mathbf{BiSect}(\text{At}(\nabla)_\bullet) \longrightarrow \mathbf{Aut}(X) \xrightarrow{\nabla \circ (-)} [X, \mathbf{B}\mathbb{G}_{\text{conn}}],$$

with the object on the right taken to be pointed by ∇ . But now that we are considering a differential cocycle, not just from a bundle cocycle, one finds that this ∞ -group of bisections does have the correct global points, but does not quite have the geometric structure on these that one would typically need in applications (such as in the theorems below in 3.9.13.5). Instead, one wants the *differentially concretified* version of $\mathbf{BiSect}(\text{At}(\nabla)_\bullet)$, along the lines of the above discussion around def. 3.9.6.4.

But in view of the above fiber sequence, there is a natural candidate of such differential concretification:

Definition 3.9.86. The *quantomorphism* ∞ -group of a \mathbb{G} -principal connection ∇ is the homotopy fiber $\mathbf{QuantMorph}(\nabla) \in \mathbf{Grp}(\mathbf{H})$ in

$$\mathbf{QuantMorph}(\nabla) \longrightarrow \mathbf{Aut}(X) \xrightarrow{\nabla \circ (-)} \mathbb{G}\mathbf{Conn}(X)$$

where the right morphism is the composite of $\nabla \circ (-)$ with the differential concretification projection $[X, \mathbf{B}\mathbb{G}_{\text{conn}}] \longrightarrow \mathbb{G}\mathbf{Conn}(X)$ of remark 3.9.51.

Remark 3.9.87. The canonical forgetful map $u_{\mathbf{B}\mathbb{G}} : \mathbf{B}\mathbb{G}_{\text{conn}} \rightarrow \mathbf{B}\mathbb{G}$ induces a morphism from the higher quantomorphism groupoid to the Atiyah groupoid of the underlying \mathbb{G} -principal bundle

$$\mathbf{At}(\nabla)_{\bullet} \longrightarrow \mathbf{At}(\nabla^0)_{\bullet}$$

which is the identity on objects. This in turn induces a canonical homomorphism

$$u_{\mathbf{B}\mathbb{G}} \circ (-) : \mathbf{QuantMorph}(\nabla) \longrightarrow \mathbf{BiSect}(\mathbf{At}(P)_{\bullet})$$

from the quantomorphism ∞ -group, def. 3.9.86, into that of bisections of the Atiyah groupoid, prop. 3.6.103. Thereby the quantomorphism ∞ -group acts on the space of sections of any associated V -fiber ∞ -bundle to ∇^0 . This is the *higher prequantum operator* action. It is the global version of the canonical action of the higher quantomorphism groupoid itself, in the sense of groupoid actions which is exhibited by the left square in the following pasting diagram of ∞ -pullbacks:

$$\begin{array}{ccccc} P \times_{\mathbb{G}} V & \longrightarrow & (P \times_{\mathbb{G}} V) // \mathbf{Qu}(\nabla) & \longrightarrow & V // G \\ \downarrow & & \downarrow & & \downarrow \rho \\ X & \longrightarrow & \mathbf{Qu}(\nabla) & \xrightarrow{\hookrightarrow} & \mathbf{B}\mathbb{G}_{\text{conn}} & \longrightarrow & \mathbf{B}\mathbb{G} \\ & & \searrow & & \nearrow & & \\ & & & \mathbf{At}(\nabla^0) & & & \end{array}$$

Given all of the above, we now have the following list of evident generalizations of traditional notions in prequantum theory.

Definition 3.9.88. Let $\nabla : X \rightarrow \mathbf{B}\mathbb{G}_{\text{conn}}$ be given, regarded as a prequantum ∞ -bundle. Then

1. the *Hamiltonian symplectomorphism group* $\mathbf{HamSympI}(\nabla) \in \mathbf{Grp}(\mathbf{H})$ is the sub- ∞ -group of the automorphisms of X which is the 1-image, def. 3.6.31, of the quantomorphisms:

$$\mathbf{QuantMorph}(\nabla) \longrightarrow \mathbf{HamSympI}(\nabla) \hookrightarrow \mathbf{Aut}(X)$$

2. for $G \in \mathbf{Grp}(\mathbf{H})$ an ∞ -group, a *Hamiltonian G -action* on X is an ∞ -group homomorphism

$$G \xrightarrow{\phi} \mathbf{HamSympI}(\nabla) \hookrightarrow \mathbf{Aut}(X) ;$$

3. an *integrated G -momentum map* is an action by quantomorphisms

$$G \xrightarrow{\hat{\phi}} \mathbf{QuantMorph}(\nabla) \hookrightarrow \mathbf{Aut}(X) ;$$

4. given a Hamiltonian G -action ϕ , the corresponding *Heisenberg* ∞ -group $\mathbf{Heis}_\phi(\nabla)$ is the homotopy fiber product in

$$\begin{array}{ccc} \mathbf{Heis}_\phi(\nabla) & \longrightarrow & \mathbf{QuantMorph}(\nabla) \\ \downarrow & & \downarrow \\ G & \xrightarrow{\phi} & \mathbf{HamSymp}(\nabla) \end{array} .$$

As in the discussion in 3.9.6, let \mathbf{H} be a cohesive ∞ -topos (such as $\mathbf{Smooth}\infty\mathbf{Grpd}$), let $\mathbb{G} \in \mathbf{Grp}_2(\mathbf{H})$ a braided ∞ -group, def. 3.6.116, let $X \in \mathbf{H}$ any object, let $\omega : X \rightarrow \Omega_{\text{cl}}^2(-, \mathbb{G})$ be a flat differential form datum and let $\nabla : X \rightarrow \mathbf{B}\mathbb{G}_{\text{conn}}$ a \mathbb{G} -prequantization of it. Then we have the following characterization of the corresponding quantomorphism ∞ -group of def. 3.9.86.

Theorem 3.9.89. *There is a long homotopy fiber sequence in $\mathbf{Grp}(\mathbf{H})$ of the form*

- if \mathbb{G} is 0-truncated:

$$\mathbb{G} \longrightarrow \mathbf{QuantMorph}(\nabla) \longrightarrow \mathbf{HamSymp}(\nabla) \xrightarrow{\nabla \circ (-)} \mathbf{B}(\mathbb{G}\mathbf{ConstFunct}(X))$$

- otherwise:

$$(\Omega\mathbb{G})\mathbf{FlatConn}(X) \longrightarrow \mathbf{QuantMorph}(\nabla) \longrightarrow \mathbf{HamSymp}(\nabla) \xrightarrow{\nabla \circ (-)} \mathbf{B}((\Omega\mathbb{G})\mathbf{FlatConn}(\nabla)) ,$$

which hence exhibits the quantomorphism group $\mathbf{QuantMorph}(\nabla) \in \mathbf{Grp}(\mathbf{H})$ as an ∞ -group extension, 3.6.14 of the ∞ -group of Hamiltonian symplectomorphisms, def. 3.9.88, by the differential moduli of flat $\Omega\mathbb{G}$ -principal connections on X , def. 3.9.54, classified by an ∞ -group cocycle which is given by postcomposition with ∇ itself.

Proof. This is an immediate variant, under the differential concretification, def. 3.9.50, of the higher Atiyah sequence Consider the natural 1-image factorization of the horizontal maps in the defining ∞ -pullback of def. 3.9.86:

$$\begin{array}{ccccc} \mathbf{QuanMorph}(\nabla) & \longrightarrow & \mathbf{HamSymp}(\nabla) & \hookrightarrow & \mathbf{Aut}(X) \\ \downarrow & & \downarrow \nabla \circ (-) & & \downarrow \nabla \circ (-) \\ * & \longrightarrow & \mathbf{B}(\Omega_\nabla(\mathbb{G}\mathbf{Conn}(X))) & \hookrightarrow & \mathbb{G}\mathbf{Conn}(X) \\ & \searrow & \downarrow \vdash \nabla & \nearrow & \\ & & & & \end{array} .$$

By homotopy pullback stability of both 1-epimorphisms and 1-monomorphisms and by essential uniqueness of 1-image factorizations this is a pasting diagram of homotopy pullback squares. The claim then follows. \square

The analogous statement also holds for Heisenberg ∞ -groups:

Corollary 3.9.90. *If $\phi : G \rightarrow \mathbf{HamSymp}(\nabla) \hookrightarrow \mathbf{Aut}(X)$ is any Hamiltonian G -action, def. 3.9.88, then the corresponding Heisenberg ∞ -group sits in the ∞ -fiber sequence*

$$(\Omega\mathbb{G})\mathbf{FlatConn}(X) \longrightarrow \mathbf{Heis}_\phi(\nabla) \longrightarrow G \xrightarrow{\nabla \circ (-)} \mathbf{B}((\Omega\mathbb{G})\mathbf{FlatConn}(\nabla)) ,$$

Proof. By the pasting law for homotopy pullbacks. \square

Example 3.9.91. For $\mathbb{G} = U(1) \in \text{Grp}(\text{Smooth}\infty\text{Grpd})$ the smooth circle group and for $X \in \text{SmoothMfd} \hookrightarrow \text{Smooth}\infty\text{Grpd}$ a connected smooth manifold, theorem 3.9.89 reproduces the traditional quantomorphism group as a $U(1)$ -extension of the traditional group of Hamiltonian symplectomorphisms, as discussed for instance in [RaSch81, Vi11].

In order to put the higher generalizations of the quantomorphism extensions into this context, we notice the following basic fact.

Proposition 3.9.92. *For $\mathbb{G} = \mathbf{B}U(1) \in \text{Grp}(\text{Smooth}\infty\text{Grpd})$ the smooth circle 2-group consider $X \in \text{SmoothMfd} \hookrightarrow \text{Smooth}\infty\text{Grpd}$ a connected and simply connected smooth manifold. Then from prop. 3.9.6.4 and example 3.9.6.5 one obtains an equivalence of smooth group stacks*

$$U(1)\mathbf{FlatConn}(X) \simeq \mathbf{B}U(1).$$

Generally, for $n \geq 1$ and for $\mathbb{G} = \mathbf{B}^n U(1) \in \text{Grp}(\text{Smooth}\infty\text{Grpd})$ the smooth circle $(n+1)$ -group, there is for X an n -connected smooth manifold an equivalence of smooth ∞ -groups

$$(\mathbf{B}^{n-1}U(1))\mathbf{FlatConn}(X) \simeq \mathbf{B}^n U(1).$$

Proof. We use the description of $U(1)\mathbf{FlatConn}(X)$ given by prop. 3.9.6.4 and example 3.9.6.5. First notice then that on a simply connected manifold there is up to equivalence just a single flat connection, hence $U(1)\mathbf{FlatConn}(X)$ is pointed connected. Moreover, an auto-gauge transformation from that single flat connection (any one) to itself is a $U(1)$ -valued function which is *constant on X* . But therefore by prop. 3.9.6.4 the U -plots of the first homotopy sheaf of $U(1)\mathbf{FlatConn}(X)$ are smoothly U -parameterized collections of constant $U(1)$ -valued functions on X , hence are smoothly U -parameterized collections of elements in $U(1)$, hence are smooth $U(1)$ -valued functions on U . These are, by definition, equivalently the U -plots of automorphisms of the point in $\mathbf{B}U(1)$.

The other cases work analogously. □

Remark 3.9.93. Therefore in the situation of prop. 3.9.92 the quantomorphism ∞ -group is a smooth 2-group extension by the circle 2-group $\mathbf{B}U(1)$. The archetypical example of $\mathbf{B}U(1)$ -extensions is the smooth *String 2-group*, def. 5.1.10. Indeed, this occurs as the Heisenberg 2-group extension of the WZW sigma-model regarded as a local 2-dimensional quantum field theory. This we turn to in 5.4.1 below.

3.9.13.6 Courant groupoids Given a \mathbb{G} -principal ∞ -connection

$$\begin{array}{ccc} & & \mathbf{B}\mathbb{G}_{\text{conn}} \\ & \nearrow \nabla & \downarrow u_{\mathbf{B}\mathbb{G}} \\ X & \xrightarrow{\nabla^0} & \mathbf{B}\mathbb{G} \end{array}$$

we have considered in 3.6.7.1.3 the corresponding higher Atiyah groupoid $\text{At}(\nabla^0)_\bullet$ and in 3.9.13.5 the higher quantomorphism groupoid $\text{At}(\nabla)$ equipped with a canonical map $\text{At}(\nabla)_\bullet \longrightarrow \text{At}(\nabla^0)_\bullet$. But in view of the towers of differential coefficients discussed in 3.9.6 this has a natural generalization to towers of higher groupoids interpolating between the higher Atiyah groupoid and the higher quantomorphism groupoid.

In particular, let $\mathbb{G} \in \text{Grp}_3(\mathbf{H})$ a sylleptic ∞ -group, def. 3.6.116, with compatibly chosen factorization of differential form coefficients and induced factorization of differential coefficients

$$\mathbf{B}^2\mathbb{G}_{\text{conn}} \longrightarrow \mathbf{B}(\mathbf{B}\mathbb{G}_{\text{conn}}) \longrightarrow \mathbf{B}^2\mathbb{G} .$$

Then in direct analogy with def. 3.9.84 we set:

Definition 3.9.94. For $\nabla^{n-1} : X \rightarrow \mathbf{B}(\mathbf{B}\mathbb{G}_{\text{conn}})$ a \mathbb{G} -principal connection without top-degree connection data as in def. 4.4.73, we say that the corresponding *higher Courant groupoid* is the corresponding higher Atiyah groupoid $\text{At}(\nabla^{n-1})_{\bullet} \in \text{Grpd}(\mathbf{H})$, hence the groupoid object which by prop. 3.6.87 is equivalent to the ∞ -groupoid with atlas given by the 1-image factorization of ∇^{n-1}

$$X \longrightarrow \text{At}(\nabla^{n-1}) := \text{im}_1(\nabla^{n-1}) .$$

Example 3.9.95. If $\mathbf{H} = \text{Smooth}\infty\text{Grpd}$ is the ∞ -topos of smooth ∞ -groupoids and $\mathbb{G} = \mathbf{B}U(1) \in \text{Grp}_{\infty}(\mathbf{H})$ is the smooth circle 2-group and if finally $X \in \text{SmoothMfd} \hookrightarrow \text{Smooth}\infty\text{Grpd}$ is a smooth manifold, then by def. 4.4.93 a map $\nabla^1 : X \rightarrow \mathbf{B}(\mathbf{B}U(1)_{\text{conn}})$ is equivalently a “ $U(1)$ -bundle gerbe with connective structure but without curving” on X .

In this case the higher Courant groupoid according to def. 3.9.94 is a smooth 2-groupoid and its ∞ -group of bisections $\mathbf{BiSect}(\text{At}(\nabla^1)_{\bullet})$ is a smooth 2-group. The points of this 2-group are equivalently pairs (ϕ, η) consisting of a diffeomorphism $\phi : X \xrightarrow{\cong} X$ and an equivalence of bundle gerbes with connective structure but without curving of the form $\eta : \phi^*\nabla^{n-1} \xrightarrow{\cong} \nabla^{n-1}$. A homotopy of bisections between two such pairs $(\phi_1, \eta_1) \rightarrow (\phi_2, \eta_2)$ exists if $\phi_1 = \phi_2$ and is then given by a higher gauge equivalence $\kappa : \eta_1 \xrightarrow{\cong} \eta_2$. Moreover, with prop. 3.9.6.4 the smooth structure on the differentially concretified 2-group of such bisections is the expected one, where U -plots are smooth U -parameterized collections of diffeomorphisms and of bundle gerbe gauge transformations.

Precisely these smooth 2-groups have been studied in [Col11]. There it was shown that the Lie 2-algebras that correspond to them under Lie differentiation are the Lie 2-algebras of sections of the *Courant Lie 2-algebroid* which is traditionally associated with a bundle gerbe with connective structure. (See the citations in [Col11] for literature on Courant Lie 2-algebroids.) Therefore the abstractly defined smooth higher Courant groupoid $\text{At}(\nabla^{n-1})$ according to def. 3.9.94 indeed is a Lie integration of the traditional Courant Lie 2-algebroid assigned to ∇^{n-1} , hence is the *smooth Courant 2-groupoid*.

Example 3.9.96. More generally, in the situation of example 3.9.95 consider now for some $n \geq 1$ the smooth circle n -group $\mathbb{G} = \mathbf{B}^{n-1}U(1)$. Then a map

$$\nabla^{n-1} : X \longrightarrow \mathbf{B}(\mathbf{B}^{n-1}U(1)_{\text{conn}})$$

is equivalently a Deligne cocycle on X in degree $(n+1)$ without n -form data.

To see what the corresponding smooth higher Courant groupoid $\text{At}(\nabla^{n-1})$ is like, consider first the local case in which ∇^{n-1} is trivial. In this case a bisection of $\text{At}(\nabla^{n-1})$ is readily seen to be a pair consisting of a diffeomorphism $\phi \in \text{Diff}(X)$ together with an $(n-1)$ -form $H \in \Omega^{n-1}(X)$, satisfying no further compatibility condition. This means that there is an L_{∞} -algebra representing the Lie differentiation of the higher Courant groupoid $\text{At}(\nabla^{n-1})_{\bullet}$ which in lowest degree is the space of sections of a bundle on X which is locally the sum $TX \oplus \wedge^{n-1}T^*X$ of the tangent bundle with the $(n-1)$ -form bundle. This is precisely what the sections of higher Courant Lie n -algebroids are supposed to be like, see for instance [Zam10].

Finally, if we are given a tower of differential refinements of \mathbb{G} -principal bundles as discussed in 3.9.6

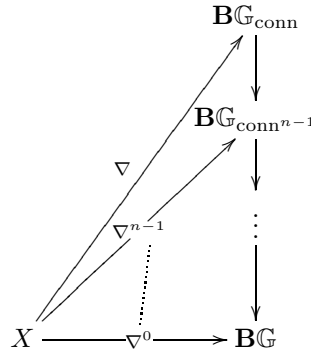

then there is correspondingly a tower of higher gauge groupoids:

$$\begin{array}{ccccccc}
& & & & \text{intermediate} & & \\
& & & & \text{differential} & & \\
& & & & \text{higher} & & \\
& & & & \text{Atiyah} & & \\
& & & & \text{groupoid} & & \\
\text{higher} & & \text{higher} & & & & \text{higher} \\
\text{Quantomorphism} & & \text{Courant} & & \cdots & & \text{Atiyah} \\
\text{groupoid} & & \text{groupoid} & & & & \text{groupoid} \\
& & & & & & . \\
\end{array}$$

$$\text{At}(\nabla)_\bullet \longrightarrow \text{At}(\nabla^{n-1})_\bullet \longrightarrow \cdots \longrightarrow \text{At}(\nabla^k) \longrightarrow \cdots \longrightarrow \text{At}(\nabla^0)$$

The further intermediate stages appearing here seem not to correspond to anything that has already been given a name in traditional literature. We might call them *intermediate higher differential gauge groupoids*. These structures are an integral part of higher prequantum geometry.

3.9.13.7 Poisson and Heisenberg Lie algebra We consider now the ∞ -Lie algebras of these ∞ -groups in prequantum geometry.

Definition 3.9.97. • The ∞ -Lie algebra

$$\mathbf{poisson}(X, \hat{\omega}) := \text{Lie}(\mathbf{QuantMorph}(\nabla))$$

of the quantomorphism group we call the *Poisson ∞ -Lie algebra* of the prequantum geometry (X, ∇) .

- The ∞ -Lie algebra of the Hamiltonian symplectomorphisms

$$\mathcal{X}_{\text{Ham}}(X, \hat{\omega}) := \text{Lie}(\mathbf{HamSympl}(\nabla))$$

we call the ∞ -Lie algebra of *Hamiltonian vector fields* of the prequantum geometry.

Remark 3.9.98. If X has a linear structure (the structure of a vector space) and ω is constant on X , then we can consider the sub ∞ -Lie algebra of $\mathbf{poisson}(X, \hat{\omega})$ on the constant and linear elements. We discuss realizations of this below in 4.4.20.5. This sub ∞ -Lie algebra we call the *Heisenberg ∞ -Lie algebra*

$$\mathbf{heis}(\nabla) \hookrightarrow \mathbf{poisson}(\nabla).$$

The corresponding sub- ∞ -group we call the *Heisenberg ∞ -group*

$$\mathbf{Heis}(\nabla) \hookrightarrow \mathbf{QuantMorph}(\nabla).$$

3.9.13.8 Prequantum states Given a prequantum geometry

$$X \xrightarrow{\nabla} \mathbf{BG}_{\text{conn}} \xrightarrow{F(-)} \Omega_{\text{cl}}^2(-, \mathbb{G})$$

as above, choose now finally a representation, def. 3.6.149, of \mathbb{G} , hence a fiber sequence in \mathbf{H} of the form

$$V \longrightarrow V//\mathbb{G} \xrightarrow{\rho} \mathbf{BG}.$$

For $U_{\mathbf{BG}} : \mathbf{BG}_{\text{conn}} \longrightarrow \mathbf{BG}$ the forgetful morphism, we obtain from the prequantum connection $\nabla \in \mathbf{H}/\mathbf{BG}_{\text{conn}}$ the underlying modulus

$$\sum_{U_{\mathbf{BG}}} \nabla \in \mathbf{H}/\mathbf{BG}$$

of the prequantum bundle proper.

Definition 3.9.99. The ρ -associated V -fiber bundle

$$E := \left(\sum_{U_{\mathbf{BG}}} \nabla \right)^* \rho \in \mathbf{H}/X$$

to $\sum_{U_{\mathbf{BG}}} \nabla$, def. 3.6.206, we call the *prequantum V -bundle* (or just *prequantum line bundle* if V is equipped compatibly with a ring structure).

Remark 3.9.100. If we write $P \rightarrow X$ for the total space projection of the prequantum bundle, sitting in the ∞ -pullback diagram

$$\begin{array}{ccc} P & \longrightarrow & * \\ \downarrow & & \downarrow \\ X & \xrightarrow{\sum_{U_{\mathbf{BG}}} \nabla} & \mathbf{BG} \end{array},$$

then by prop. 3.6.206 the total space projection of the prequantum line bundle is the left morphism in the ∞ -pullback diagram

$$\begin{array}{ccc} P \times_{\mathbf{G}} V & \longrightarrow & V//\mathbf{G} \\ \downarrow & & \downarrow \rho \\ X & \xrightarrow{\sum_{U_{\mathbf{BG}}} \nabla} & \mathbf{BG} \end{array}.$$

Definition 3.9.101. The space of sections, def. 3.6.217, of the prequantum line bundle

$$\Gamma_X(E) \in \mathbf{H}$$

we call the *prequantum space of states*.

Remark 3.9.102. By prop. 3.6.227 the prequantum space of states is equivalently expressed as

$$\Gamma_X(E) \simeq \prod_{\mathbf{BG}} \left[\sum_U \nabla, \rho \right].$$

3.9.13.9 Prequantum operators

Definition 3.9.103. The *prequantum operator action* of the quantomorphism group $\mathbf{QuantMorph}(\nabla)$, def. 3.9.13.5, on the space of prequantum states $\Gamma_X(E)$, def. 3.9.101, is the action, def. 3.6.149,

$$\begin{array}{ccc} \Gamma_X(E) & \longrightarrow & \Gamma_X(E)//\mathbf{QuantMorph}(\nabla) \\ & & \downarrow \rho_{\text{prequant}} \\ & & \mathbf{BQuantMorph}(\nabla) \end{array}$$

given by the canonical precomposition action, example 3.6.238, of $\mathbf{Aut}_{\mathbf{H}}(\sum_U \nabla)$ on $\Gamma_X(E) \simeq \prod_{\mathbf{BG}} \left[\sum_U \nabla, \rho \right]_{\mathbf{H}}$ (remark 3.9.102) restricted to a $\mathbf{QuantMorph}(\nabla) := \mathbf{Aut}_{\mathbf{H}}(\nabla)$ -action, def. 3.6.235, along the canonical morphism $p_U : \mathbf{Aut}_{\mathbf{H}}(\nabla) \rightarrow \mathbf{Aut}_{\mathbf{H}}(\sum_U \nabla)$.

Remark 3.9.104. The prequantum operator action of def. 3.9.103 is exhibited by the following pasting diagram of ∞ -pullback squares.

$$\begin{array}{ccccc}
 \Gamma_X(E) \simeq \prod_{\mathbf{BG}} [\sum_U \nabla, \rho] & \longrightarrow & \prod_{\mathbf{BG}} \left(\left[\sum_U \nabla, \rho \right] // \prod_U \mathbf{Aut}(\nabla) \right) & \longrightarrow & \prod_{\mathbf{BG}} \left(\left[\sum_U \nabla, \rho \right] // \mathbf{Aut}(\sum_U \nabla) \right) . \\
 \downarrow & & \downarrow & & \downarrow \\
 * & \longrightarrow & \mathbf{B} \prod_{\mathbf{BG}} \left(\prod_U \mathbf{Aut}(\nabla) \right) & \xrightarrow{\mathbf{B} \prod_{\mathbf{BG}} (pv)} & \mathbf{B} \prod_{\mathbf{BG}} \left(\mathbf{Aut} \left(\sum_U \nabla \right) \right) \\
 \parallel & & \parallel & & \parallel \\
 * & \longrightarrow & \mathbf{B} \left(\mathbf{Aut}_{\mathbf{H}}(\nabla) \right) & \longrightarrow & \mathbf{B} \left(\mathbf{Aut}_{\mathbf{H}} \left(\sum_U \nabla \right) \right) \\
 \parallel & & \parallel & & \parallel \\
 * & \longrightarrow & \mathbf{B} \left(\mathbf{QuantMorph}(\nabla) \right) & &
 \end{array}$$

This uses that the dependent product is right adjoint and hence preserves ∞ -pullbacks (as well as group structure).

Remark 3.9.105. A prequantum state is given by a diagram

$$\begin{array}{ccc}
 X & \xrightarrow{\psi} & V//G \\
 \searrow & \swarrow & \\
 \sum_U \nabla & & \mathbf{BG} \\
 \swarrow & \searrow & \\
 & \rho &
 \end{array}$$

and a prequantum operator by a diagram

$$\begin{array}{ccc}
 X & \xrightarrow{\phi} & X \\
 \searrow & \swarrow & \\
 \nabla & & \mathbf{BG}_{\text{conn}} \\
 \swarrow & \searrow & \\
 & \rho &
 \end{array}$$

Then the result of the action is the new prequantum state $O(\psi)$ given by the pasting diagram

$$\begin{array}{ccccc}
 X & \xrightarrow{\phi} & X & \xrightarrow{\psi} & V//G \\
 \searrow & \swarrow & \downarrow & \swarrow & \\
 \sum_U \nabla & & \mathbf{BG}_{\text{conn}} & & \rho \\
 \swarrow & \searrow & \downarrow & \swarrow & \\
 & & \mathbf{BG} & &
 \end{array}$$

(where all the 2-cells are notationally suppressed, for readability).

3.9.14 Local prequantum field theory

We discuss now a formalization *local prequantum field theory* (see 1.2.10 and 1.2.11 in the introduction) in cohesive ∞ -toposes.

The contents of this section draw from discussion with Domenico Fiorenza.

- 3.9.14.1 – Introduction;
- 3.9.14.2 – Bulk field theory;
- 3.9.14.3 – Local action functionals for the bulk field theory;
- 3.9.14.4 – Boundary field theory
- 3.9.14.5 – Corner field theory
- 3.9.14.6 – Defect field theory

3.9.14.1 Introduction The quantum field theories (QFTs) of interest, both in nature as well as theoretically, are typically not generic examples of the axioms of quantum field theory (see [SaSc11b] for a survey of modern formalizations of QFT) but rather are special in two respects:

1. they arise from geometric data – the Lagrangian and action functional – via some process of quantization, and notably from *higher geometric data* such as Lagrangian densities, pre-symplectic currents and higher gauge fields, subject to gauge equivalences, and higher order gauge of gauge transformations;
2. they are *local* in that the spaces of configurations (states) which they assign to a piece of worldvolume/spacetime are determined from gluing the data assigned to pieces of any decomposition of the worldvolume/spacetime.

While quantized field theories (topological QFTs as well as non-topological boundary quantum field theories) are axiomatically characterized by the cobordism theorem [L-TFT] (see [Be10] for a brief survey), here we are after understanding the axiomatization the local higher geometric *pre-quantum* data of those quantum field theories that arise from quantization. This also proceeds by the cobordism theorem, but with the “linear” n -categorical coefficients appropriate for quantum field theories replaced by non-linear geometric n -categorical coefficients. Since the natural context for higher geometry are higher toposes [L-Topos] and specifically cohesive higher toposes and since, as we will discuss, local action functionals are naturally objects in slices of such higher toposes over differential coefficient objects, the n -categorical coefficients that we consider are higher correspondences in such higher slice toposes.

For the case that the ambient higher topos encodes *discrete geometry* (suitable for the discussion of finite gauge theories such as Dijkgraaf-Witten theory) the definition of local prequantum field theory that we consider is that indicated in section 3 of [FHLT09].

One goal here is to show that by allowing the ambient higher topos to be more general and in particular by choosing differentially cohesive higher toposes, the genuine differential geometric data familiar from general field theories is naturally captured and usefully analyzed.

3.9.14.1.1 Action functionals and correspondences Traditionally in physics one considers (smooth) spaces of trajectories of physical fields (“spaces of histories”), which we will denote by $\mathbf{Fields}_{\text{traj}}$, and considers smooth functions on these spaces valued in the circle group, called the *exponentiated action functionals* or the *phases*

$$\exp\left(\frac{i}{\hbar}S\right) : \mathbf{Fields}_{\text{traj}} \longrightarrow U(1),$$

where $2\pi\hbar \in \mathbb{R}$ denotes the choice of isomorphism

$$U(1) \simeq \mathbb{R}/2\pi\hbar\mathbb{Z},$$

of the circle group with the quotient of the additive group of real numbers by a copy of the integers, which physically is “Planck’s constant”, see def. 4.4.128 below. By the *principle of extremal action* the critical locus of such functionals encodes those trajectories which are realized in macroscopic physics (classical physics), while integrals over trajectory space (“path integrals”) of such functionals are to produce the integral kernels that encode the microscopic dynamics (quantum mechanics).

For example for X a smooth manifold to be thought of as spacetime, and for ∇ a circle-principal connection on X , to be thought of as an electromagnetic field, then the Lorentz force inter-action between a charged particle that travels around loops $S^1 \rightarrow X$ in spacetime and the background electromagnetic field is encoded by the holonomy functional

$$\exp\left(\frac{i}{\hbar} S_{\text{Lor}}^\nabla\right) := \text{hol}_\nabla : [S^1, X] \rightarrow U(1),$$

where $[S^1, X]$ denotes the loop space of X regarded as a smooth space (for instance as a Fréchet manifold or as a diffeological space) and where hol_∇ is the function that sends a curve in X to its holonomy under ∇ .

More generally, action functionals are in fact not $U(1)$ -valued functions, but are sections of $U(1)$ -principal bundles. To say this more formally, we introduce the notation $\mathbf{BU}(1)$ for the universal moduli stack of smooth $U(1)$ -principal bundles. This is characterized as being the object such that for X any smooth manifold then homomorphisms $X \rightarrow \mathbf{BU}(1)$ are equivalent to smooth $U(1)$ -principal bundles on X and homotopies between such are equivalently to smooth isomorphisms/gauge transformations between those. For an introduction into the language of smooth (moduli) stacks that we are using here see [FSS13a].

As the notation suggests, the characteristic feature of $\mathbf{BU}(1)$ is that it is the *delooping* of the group $U(1)$, and the boldface \mathbf{B} is to indicate that we consider this with everything equipped with its smooth geometric structure. This means that $U(1)$ as a smooth Lie group is the homotopy fiber product of the point with itself inside $\mathbf{BU}(1)$. By the universal property of the homotopy fiber construction this in turn means that an exponentiated action functional as above is equivalently a homotopy from the pullback of the trivial $U(1)$ -principal bundle to itself, as follows:

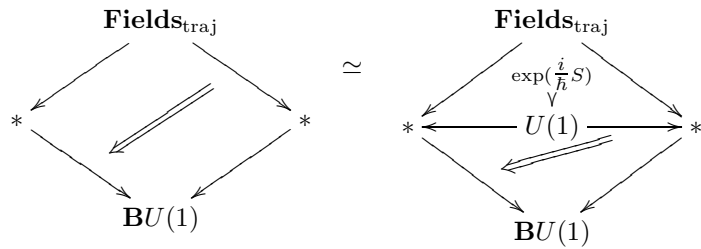

Indeed, in the above example of the electromagnetic interaction, if instead of closed particle trajectories of the shape of a circle we consider trajectories of the shape of the interval $I := [0, 1]$, regarded as a smooth manifold with boundary $\partial I = * \amalg *$, then the inter-action functional is not given by the holonomy but more generally by the *parallel transport* of the connection ∇ along paths, which is not a function map but is a section of the oriented pullback of the background bundle along the path endpoint evaluation map, in that it is a homotopy diagram like this:

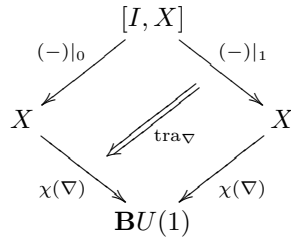

Here $\chi(\nabla)$ is the class (or rather the *modulus/cocycle*) of the $U(1)$ -principal bundle underlying the $U(1)$ -principal connection ∇ . We discuss this and its higher dimensional generalization below in 4.4.18.

This diagram is a *correspondence* from the background field $\chi(\nabla)$ to itself, regarded as an object in the *slice topos* over $\mathbf{BU}(1)$. Since $U(1)$ is the “group of phases” in traditional formulations of physics, $\mathbf{BU}(1)$ here plays the role of a *higher group of phases*. Below we see that such correspondences in slices over higher groups of phases serve to encode local pre-quantum field theory quite generally.

Another archetypical example for such correspondences – which is *almost* familiar from traditional literature – are pre-quantizations of *Lagrangian correspondences* in symplectic geometry [We71, We83]. In this

context, consider (X, ω) a symplectic manifold, to be thought of as the phase space of some physical system. In the spirit of the above discussion we stick to representing all extra structure on spaces in terms of maps into moduli stacks of these structures, and hence we think of the symplectic differential 2-form $\omega \in \Omega^2(X)$ here a morphism

$$\omega : X \longrightarrow \Omega_{cl}^2$$

to the smooth moduli space of closed differential 2-forms (technically this is simply the sheaf of closed 2-forms on the site of all smooth manifolds). In terms of such maps we have for instance that a diffeomorphism $\phi : X \longrightarrow X$ is a *symplectomorphism* precisely if it makes the following diagram of smooth spaces commute:

$$\begin{array}{ccc} X & \xrightarrow{\phi} & X \\ & \searrow \omega & \swarrow \omega \\ & \Omega^2 & \end{array} .$$

Equivalently, if we write $(\text{id}, \phi) : \text{graph}(\phi) \hookrightarrow X \times X$ for the graph of the function ϕ , then ϕ is a symplectomorphism precisely if it induces a correspondence from ω to itself regarded as an object in the slice topos over Ω^2 as follows:

$$\begin{array}{ccc} & \text{graph}(\phi) & \\ p_1 \swarrow & & \searrow p_2 \\ X & & X \\ & \searrow \omega & \swarrow \omega \\ & \Omega^2 & \end{array} .$$

While such *Lagrangian correspondences* have long been studied and have been proposed as a foundation for geometric quantization [We83], it is well known that a symplectic manifold is too crude a model for a physical phase space, and that more accurately a physical phase space is a “pre-quantization” of a symplectic manifold, namely a choice of $U(1)$ -principal connection ∇ whose curvature 2-form coincides with the symplectic form $F_\nabla = \omega$. (See the introduction of [FRS13a] for a review of geometric prequantization and for further pointers to the literature.)

In order to see the effect of this refinement on the above discussion, observe that sending a $U(1)$ -principal connection ∇ to its curvature 2-form F_∇ is a natural operation, compatible with gauge equivalences, and hence is given by a universal morphism of stacks

$$F_{(-)} : \mathbf{BU}(1)_{\text{conn}} \longrightarrow \Omega_{cl}^2$$

from the universal moduli stack $\mathbf{BU}(1)_{\text{conn}}$ of $U(1)$ -principal connections to the universal smooth space of closed differential 2-forms. In terms of this a prequantization of a symplectic manifold (X, ω) is a lift ∇ in the diagram

$$\begin{array}{ccc} X & \xrightarrow{\nabla} & \mathbf{BU}(1)_{\text{conn}} \\ & \searrow \omega & \downarrow F_{(-)} \\ & & \Omega^2 \end{array} .$$

In view of this it is clear what a *pre-quantized Lagrangian correspondence* should be: this is a lift of the above Lagrangian correspondence through the universal curvature homomorphism to a correspondence in

the slice over $\mathbf{BU}(1)_{\text{conn}}$ of the form

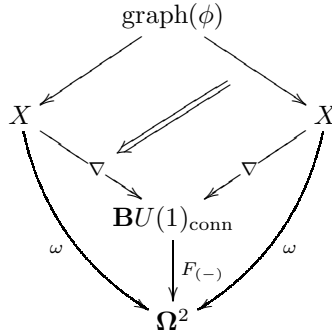

While this is an obvious refinement of the traditional notion of Lagrangian correspondence, it does not seem to have found due attention in the existing literature. Its relevance may be seen from the following observation [FRS13a] which we discuss in more detail below in 1.2.10: Smooth 1-parameter flows of prequantized Lagrangian correspondences as above are given precisely by choices of smooth functions $H \in C^\infty(X)$, where such a function induces the flow that sends $t \in \mathbb{R}$ to the correspondence

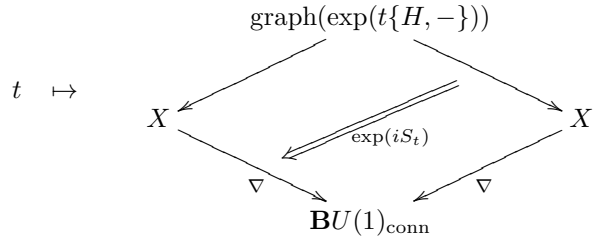

where $\exp(t\{H, -\})$ is the *Hamiltonian flow* induced by H and $S_t = \int_0^t L dt$ is its *Hamilton-Jacobi action*, namely the integral of the *Lagrangian* L which is the Legendre transform of H . Hence the notion of flows of Lagrangian correspondences unifies a fair bit of traditional classical mechanics [Ar89]. We survey in 1.2.10 how when this is lifted to Lagrangian correspondences between prequantum n -bundles for $n \in \mathbb{N}$ as in [FRS13a], then n -dimensional flows in n -fold correspondences encode the equations of motion of local Lagrangians on jet spaces in deDonder-Weyl-Hamiltonian (“multisymplectic”) formulation.

In summary, the description of classical mechanics here identifies prequantized Lagrangian correspondences schematically as follows:

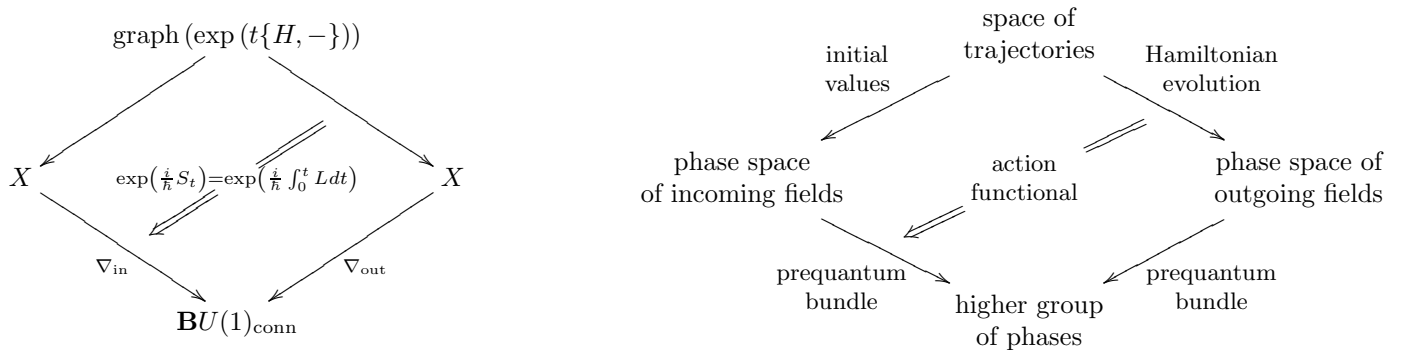

This state of affairs turns out to be essentially a blueprint for the formulation of local prequantum field theory that we obtain below in 3.9.14, via maps from cobordisms to n -fold correspondences in higher slices toposes.

3.9.14.1.2 Local Lagrangians and higher differential cocycles To see the need for passing from traditional symplectic geometric and prequantum bundles to prequantum n -bundles, first observe the traditional formulation of higher dimensional field theory along the above lines. Let **Fields** be a moduli space/moduli stack of fields of some field theory – for instance $\mathbf{Fields} = \mathbf{BG}_{\text{conn}}$ the universal moduli stack of G -principal connections of some Lie group G , for the case of G -gauge theory. Then over a closed manifold Σ_{n-1} of dimension $(n-1)$, to be thought of as a spatial slice of spacetime, the space of field configurations on Σ_{n-1} is the mapping stack $\mathbf{Field}(\Sigma_{n-1}) = [\Sigma_{n-1}, \mathbf{Fields}]$ (or some slight variant of this, such as its “differential concretification” [FRS13a], see the examples below in 5 for more). Now the evolution of fields on Σ_{n-1} in time is a trajectory given by a map

$$I \longrightarrow [\Sigma_{n-1}, \mathbf{Fields}]$$

which by the internal hom-adjunction is equivalently a field configuration

$$\phi \in [\Sigma_{n-1} \times I, \mathbf{Fields}]$$

on the cylinder over Σ_{n-1} . Hence the n -dimensional field theory *transgressed* to maps out of Σ_{n-1} looks like a mechanical system with space of fields being the mapping space $[\Sigma_{n-1}, \mathbf{Fields}]$.

For instance if the field theory is the $(n = p + 1)$ -dimensional worldvolume theory of a p -brane which is charged under a $(p + 1)$ -form connection ∇ , then the action functional over such cylinders is of the same general form as that for electrically charged particles above

$$\begin{array}{ccc}
 & [I, [\Sigma_p, \mathbf{Fields}]] & \\
 (-)|_0 \swarrow & & \searrow (-)|_1 \\
 [\Sigma_p, \mathbf{Fields}] & \xrightarrow{\text{tra}_\nabla} & [\Sigma_p, \mathbf{Fields}] \\
 \chi\left(\exp\left(\frac{i}{\hbar} \int_{\Sigma_{n-1}} \nabla\right)\right) \searrow & & \swarrow \chi\left(\exp\left(\frac{i}{\hbar} \int_{\Sigma_{n-1}} \nabla\right)\right) \\
 & \mathbf{BU}(1) &
 \end{array} ,$$

where now $\exp\left(\frac{i}{\hbar} \int_{\Sigma_p} \nabla\right)$ is an ordinary 1-form connection on the mapping space $[\Sigma_p, \mathbf{Fields}]$, obtained by *transgression* of the given $(p + 1)$ -form connection ∇ on the moduli space of fields itself.

While in this fashion all n -dimensional field theories may be thought of in terms of mechanics (1-dimensional field theory) on the space of fields over $(n - 1)$ -dimensional spatial slices, restricting to this perspective alone loses the manifest *locality* of the theory: the data for codimension-1 manifolds Σ_{n-1} is not necessarily represented as obtained by gluing data on smaller patches. In physics terminology, essentially this problem is known as the problem of the *non-covariance of canonical quantization*, referring to the explicit and non-natural choice of $(n - 1)$ -dimensional spatial slices Σ_{n-1} of spacetime.

Imposing locality then amounts to requiring that all the data of the n -dimensional theory can be reconstructed by the data for codimension- n manifolds, hence for collections of just points. To continue the pattern of phases $U(1)$ and higher phases $\mathbf{BU}(1)_{\text{conn}}$ that we have seen emerging in codimension-0 and 1, one sees that the natural codimension- k datum for a n -dimensional prequantum theory is that of a morphism of stacks of the form

$$[\Sigma_{n-k}, \mathbf{Fields}] \longrightarrow \mathbf{B}^{n-k}U(1)_{\text{conn}} ,$$

where on the right we have the $(n - k)$ -stack of $(n - k)$ -form connections on higher $(n - k)$ -circle bundles (bundle $(n - k - 1)$ -gerbes with connection). An introduction to this perspective is in [FSS13a].

Going down to codimension n and observing that if $*$ denotes the 1-point manifold then $[\ast, \mathbf{Fields}] \cong \mathbf{Fields}$, we see that imposing locality on a prequantum theory means that the whole theory, in any codimension, is determined by a single datum: a morphism of higher stacks of the form

$$\mathbf{L} : \mathbf{Fields} \longrightarrow \mathbf{B}^n U(1)_{\text{conn}} .$$

Notice that such an n -connection on the moduli stack of fields is locally given by a differential n -form. Moreover, this being an n -form on a stack means that for each test manifold Σ this is an n -form (locally) on Σ , depending on the field configurations on Σ . Such a form is familiar in, and central to, traditional prequantum field theory. It is the *Lagrangian* of the theory; whence the choice of symbol “ \mathbf{L} ”.

Indeed, once such an \mathbf{L} is given, all the codimension- k prequantum $(n - k)$ - $U(1)$ -bundles with connections on the moduli stacks $[\Sigma_{n-k}, \mathbf{Fields}]$ are naturally obtained by transgression of n -bundles (fiber integration/push-forward on cocycles in differential cohomology):

$$\exp\left(\frac{i}{\hbar} \int_{\Sigma_{n-k}} \mathbf{L}\right) : [\Sigma_{n-k}, \mathbf{Fields}] \xrightarrow{[\Sigma_{n-k}, \mathbf{L}]} [\Sigma_{n-k}, \mathbf{B}^n U(1)_{\text{conn}}] \xrightarrow{\exp\left(\frac{i}{\hbar} \int_{\Sigma_{n-k}} (-)\right)} \mathbf{B}^{n-k} U(1)_{\text{conn}} .$$

The rightmost map here is fiber integration in Deligne cohomology, seen as morphism of smooth stacks, this we describe below in 4.4.18. In particular, for $k = 0$ one recovers the action functional as

$$\exp\left(\frac{i}{\hbar} S_{\Sigma_n}\right) = \exp\left(\frac{i}{\hbar} \int_{\Sigma_n} \mathbf{L}\right) : [\Sigma_n, \mathbf{Fields}] \longrightarrow \mathbf{B}^0 U(1)_{\text{conn}} \simeq U(1) .$$

The universal curvature morphisms

$$\text{curv} : \mathbf{B}^{n-k} U(1)_{\text{conn}} \longrightarrow \Omega_{\text{cl}}^{n-k+1}$$

endow the moduli spaces of field configurations with canonical closed degree $n - k + 1$ differential forms. In the traditional case, if \mathbf{Fields} here is the jet bundle to a field bundle, then this is the *pre-symplectic current density* known from the “covariant phase space” formulation of classical field theory [Zu87, CrWi87]. The pre-quantum theory of such “multisymplectic” or “ n -plectic” structure has been described systematically in [FRS13a]. For $k = 1$ this is the traditional pre-symplectic structure on $[\Sigma_{n-1}, \mathbf{Fields}]$, so the “local prequantization” can be seen as a *de-transgression* of this pre-symplectic structure to a pre- n -plectic structure on the stack of fields.

In this fashion we consider here differential n -cocycles $\mathbf{L} : \mathbf{Fields} \longrightarrow \mathbf{B}^n U(1)_{\text{conn}}$ on higher moduli stacks as pre-quantized local Lagrangians for n -dimensional field theories. More precisely, these define “bulk” field theories on n -dimensional worldvolumes/spacetimes without physical boundaries or other singularities (“defects”).

3.9.14.1.3 Boundary field theory and twisted relative cohomology We observe in 3.9.14.4 below that by the full cobordism theorem in the presence of boundaries and singularities, a codimension-1 boundary condition for a local prequantum field theory $\mathbf{L} : \mathbf{Fields} \rightarrow \mathbf{B}^n U(1)_{\text{conn}}$ as above is equivalently the data of a correspondence of the form

$$\begin{array}{ccc} & \mathbf{Fields}_{\text{bdr}} & \\ & \swarrow & \searrow \\ * & & \mathbf{Fields} \\ & \searrow & \swarrow \\ & \mathbf{B}^n U(1)_{\text{conn}} & \end{array} ,$$

$\begin{array}{c} \text{0} \\ \downarrow \\ \mathbf{B}^n U(1)_{\text{conn}} \end{array}$
 $\begin{array}{c} \mathbf{L} \\ \downarrow \\ \mathbf{B}^n U(1)_{\text{conn}} \end{array}$

hence a choice of boundary fields $\mathbf{Fields}_{\text{bdr}}$, a choice of map from boundary fields into bulk fields, and a choice of trivialization of the pre-quantized bulk field Lagrangian after restriction to the boundary fields.

The prototypical example of this is the relation between 3d *Chern-Simons theory* and 4d “univresal topological Yang-Mills theory”, which we discuss below in 5.7.2. That 3d Chern-Simons theory is a theory

which ultimately deals with boundaries of 4-manifolds is something coming from the very origin of the theory [ChSi74]. In the language of smooth moduli stacks [FRS13a] this is completely formalized and summarized in the following (homotopy) commutative diagram

$$\begin{array}{ccc}
 & \mathbf{B}G_{\text{conn}} & \\
 & \downarrow \text{cs} & \\
 & \mathbf{B}^3U(1)_{\text{conn}} & \xrightarrow{\langle F(-) \wedge F(-) \rangle} \\
 * & \swarrow & \searrow F(-) \\
 & \Omega_{\text{cl}}^4 & \\
 & \downarrow \mathbf{L}_{\text{tYM}} & \\
 & \mathfrak{b}\mathbf{B}^4U(1) & \\
 & \uparrow 0 & \\
 & * &
 \end{array}$$

(pb)

where $\mathbf{B}G_{\text{conn}}$ is the stack of principal G -bundles with connection for a compact simple and simply connected Lie group G ,

$$\langle F(-) \wedge F(-) \rangle : \mathbf{B}G_{\text{conn}} \rightarrow \Omega_{\text{cl}}^4$$

is the *Chern-Weil* 4-form representing the fundamental degree four characteristic class of G , and

$$\text{cs} : \mathbf{B}G_{\text{conn}} \rightarrow \mathbf{B}^3U(1)_{\text{conn}}$$

is the Chern-Simons action functional lifted to a morphism of stacks from $\mathbf{B}G_{\text{conn}}$ to the 3-stack of $U(1)$ -3-bundles with connection (see [FSS13a] for details). In the lower part of the diagram,

$$\mathbf{L}_{\text{tYM}} : \Omega_{\text{cl}}^4 \longrightarrow \mathfrak{b}\mathbf{B}^4U(1)$$

is the canonical embedding of closed 4-forms into the stack of flat $U(1)$ -4-bundles with connection. Here we are denoting it by the symbol \mathbf{L}_{tYM} since we are physically interpreting it as the the Lagrangian of *topological 4d Yang-Mills theory*. The lower part of the diagram is what exhibits 3d Chern-Simons as a boundary theory for 4d topological Yang-Mills. More precisely, since the lower part of the diagram is a homotopy pullback, it exhibits $\mathbf{B}^3U(1)_{\text{conn}}$ as the *universal* boundary condition for 4d topological Yang-Mills. we will come back to this in detail in Section 5.7.2.2.

Finally, in a fully extended field theory, going from the bulk to the boundary is only the first step: one can go in higher codimension to boundaries of boundaries (or corners) or consider high codimension submanifolds of the bulk. For instance, in 4d topological Yang-Mills, this is the way Wess-Zumino-Witten theory and and Wilson loop actions appears as a codimension-2 corner theory and as codimension-3 defects, respectively. We will recover these as examples of more general corner and defect theories in Section 5.6.

A list of examples of twisted boundary fields is discussed in detail below in 5.2.

3.9.14.2 The local bulk fields

Definition 3.9.106. For $n \in \mathbb{N}$, we write Bord_n^\otimes for the symmetric monoidal (∞, n) -category of n -dimensional framed cobordism. For \mathcal{C}^\otimes any symmetric monoidal (∞, n) -category, a *local topological field theory* in dimension n with coefficients in \mathcal{C} is a symmetric monoidal (∞, n) -functor

$$Z : \text{Bord}_n^\otimes \rightarrow \mathcal{C}^\otimes .$$

By the cobordism hypothesis, Bord_n^\otimes is the free symmetric monoidal (∞, n) -category with full duals generated by a single object $*$. This means that an n -dimensional local topological field theory is completely determined by the object $Z(*)$ in \mathcal{C}^\otimes and that this object is necessarily a fully dualizable object.

Remark 3.9.107. Note the slight notational difference to [L-TFT]: there the undecorated symbols “Bord $_n$ ” denote *framed* cobordisms.

The following definition is sketched in section 3.2 of [L-TFT] (there written “Fam $_n$ ” instead of “Corr $_n$ ”).

Definition 3.9.108. Write

$$\text{Corr}_1 := \left\{ i \longleftarrow c \longrightarrow o \right\}$$

for the *category free on a single correspondence*, i.e. consisting of three objects and two non-identity morphisms from one to the other two. For $n \in \mathbb{N}$ write

$$\text{Corr}_n := (\text{Corr}_1)^{\times n}$$

for the n -fold cartesian product of this category with itself. Finally, $\text{Corr}_n(\mathbf{H})$ is the ∞ -groupoid of functors from Corr_n to \mathbf{H} .

Remark 3.9.109. Under composition of correspondences by fiber product of maps to a common face, this naturally carries the structure of an n -fold category object in $\infty\text{-Grpd}$, hence of an (∞, n) -category. Moreover, from the cartesian product in \mathbf{H} the (∞, n) -category $\text{Corr}_n(\mathbf{H})$ inherits a natural structure of symmetric monoidal (∞, n) -category, which we will denote $\text{Corr}_n(\mathbf{H})^{\otimes}$

Example 3.9.110. By definition, Corr_n is the terminal category, so a 0-morphism (i.e., an object) in $\text{Corr}_n(\mathbf{H})$ is just an object in \mathbf{H} . A 1-morphism in $\text{Corr}_n(\mathbf{H})$ is a diagram in \mathbf{H} of the form

$$A_i \longleftarrow A_c \longrightarrow A_o .$$

In the application to prequantum field theory such a diagram is typically interpreted as follows: A_i is a moduli stack of fields on an incoming piece of worldvolume and A_o that of field on an outgoing piece. The object A_c is that of fields on a piece of worldvolume connecting these two pieces, putting them in correspondence, hence A_c is the collection of *trajectories* of field configurations from the incoming to the outgoing piece. The left map sends such a trajectory to its initial configuration, the right one to its final configuration. A 2-morphism in $\text{Corr}_n(\mathbf{H})$ is a diagram in \mathbf{H} of the form

$$\begin{array}{ccccc} A_{ii} & \longleftarrow & A_{ic} & \longrightarrow & A_{io} \\ \uparrow & & \uparrow & & \uparrow \\ A_{ci} & \longleftarrow & A_{cc} & \longrightarrow & A_{co} \\ \downarrow & & \downarrow & & \downarrow \\ A_{oi} & \longleftarrow & A_{oc} & \longrightarrow & A_{oo} , \end{array}$$

and so on. Composition of morphisms is via homotopy fiber products in \mathbf{H} . For instance, the composition of the two 1-morphisms

$$X \longleftarrow Y \longrightarrow Z \quad \text{and} \quad Z \longleftarrow S \longrightarrow T$$

is the 1-morphism

$$X \longleftarrow Y \times_Z S \longrightarrow T .$$

In the above interpretation of these correspondences in prequantum field theory, this operation corresponds to gluing or concatenating trajectories of field configurations whenever they match over their outgoing/ingoing pieces of worldvolume, respectively. The compositions of higher morphisms are defined analogously.

The following proposition appears essentially as remark 3.2.3 in [L-TFT]. We spell of some details of the proof.

Proposition 3.9.111. For all $n \in \mathbb{N}$, every object $X \in \text{Corr}_n(\mathbf{H})^\otimes$ is fully dualizable and is in fact its own full dual. The k -dimensional trace of the identity on X in $\text{Corr}_n(\mathbf{H})^\otimes$ is its free k -sphere space object:

$$\dim_k(X) \simeq [\Pi(S^k), X],$$

seen as a k -fold correspondence from the terminal object to itself.

Proof. Let $X \in \mathbf{H} \leftrightarrow \text{Corr}_n(\mathbf{H})$ be any object.

The first step is to exhibit X as the ordinary dual of itself. For this, take the co-evaluation and evaluation morphisms $\epsilon : \mathbb{I} \rightarrow X \times X$ and $\eta : X \times X \rightarrow \mathbb{I}$ to be given by the “C” and by the “D”, i.e. in \mathbf{H} by the correspondences

$$* \longleftarrow X \xrightarrow{\Delta_X} X \times X \quad \text{and} \quad X \times X \xleftarrow{\Delta_X} X \longrightarrow *,$$

where Δ_X denotes the diagonal map for X . Notice that this diagonal map is equivalent to the evaluation at the two endpoints of the interval (1-disk) $\Pi(D^1)$ in the mapping space $[\Pi(D^1), X]$, so that ϵ is equivalent to

$$* \longleftarrow [\Pi(D^1), X] \xrightarrow{(\text{ev}_0, \text{ev}_1)} X \times X,$$

and similarly for η .

For ϵ and η to exhibit a self-duality, the zig-zig-identities

$$X \xrightarrow{X \times \epsilon} X \times X \times X \xrightarrow{\eta \times X} X \quad \text{and} \quad X \xrightarrow{\epsilon \times X} X \times X \times X \xrightarrow{\eta \times X} X$$

id_X id_X

have to hold as diagram in $\text{Corr}_n(\mathbf{H})$. Indeed, as a composite of correspondences this is given in \mathbf{H} by

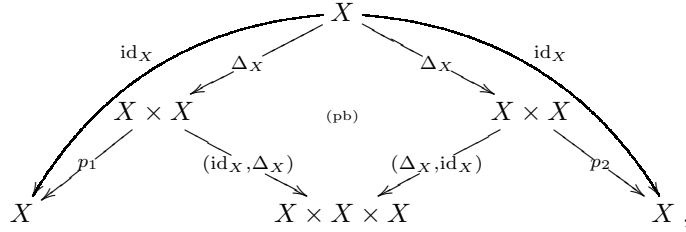

and similarly for the other composite. As a consequence, the trace of the identity of X

$$\text{tr}(\text{id}_X) := \mathbb{I} \xrightarrow{\epsilon} X \times X \xrightarrow{\eta} \mathbb{I}$$

is given by the correspondence

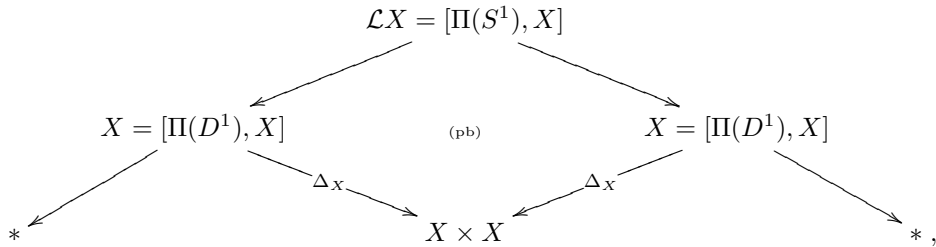

Hence

$$\dim_1(X) \simeq \mathcal{L}X \simeq [\Pi(S^1), X],$$

which amounts to the pictorial identity $\mathcal{D} \circ \mathcal{C} \cong \mathcal{O}$.

Next, to exhibit the self-duality (ϵ, η) on X as a full duality, we need to produce full adjoints ϵ^* and η^* of ϵ and of η , respectively with units

$$\begin{array}{c} \text{II} \\ \curvearrowright \\ \epsilon \\ \text{II} \end{array} \xrightarrow{\epsilon} X \times X \xrightarrow{\epsilon^*} \text{II} \quad , \quad \begin{array}{c} \text{II} \\ \curvearrowright \\ \eta^* \\ \text{II} \end{array} \xrightarrow{\eta^*} X \times X \xrightarrow{\eta} \text{II}$$

and similar co-units. Here we may choose $\eta^* := \epsilon$ and $\epsilon^* := \eta$ and we take their unit and its dual

$$\begin{array}{c} \text{II} \\ \uparrow \eta \\ \text{id} \Leftrightarrow X \times X \\ \downarrow \epsilon \\ \text{II} \end{array}$$

to be the given by the 2-fold correspondences in \mathbf{H} which exhibit the “cap” and the “cup”:

$$\begin{array}{ccc} * & \leftarrow & * \\ \uparrow & & \uparrow \\ * & \leftarrow & X \\ \downarrow & & \downarrow \\ * & \leftarrow & * \end{array} \xrightarrow{\quad} [\Pi(S^1), X] \quad \text{and} \quad \begin{array}{ccc} * & \leftarrow & * \\ \uparrow & & \uparrow \\ [\Pi(S^1), X] & \leftarrow & X \\ \downarrow & & \downarrow \\ * & \leftarrow & * \end{array}$$

and take the co-unit and its dual

$$\begin{array}{c} X \times X \xrightarrow{\eta} \text{II} \xrightarrow{\epsilon} X \times X \\ \quad \quad \quad \Downarrow \\ \quad \quad \quad \text{id} \end{array}$$

to be given by the “saddle” correspondence¹⁴,

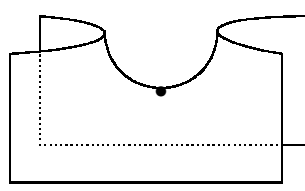
$$\begin{array}{ccccc} X \times X & \xleftarrow{\Delta_X \circ p_1} & X \times X & \xrightarrow{\Delta_X \circ p_2} & X \times X \\ \text{id}_{X \times X} \uparrow & & \Delta_X \uparrow & & \text{id}_{X \times X} \uparrow \\ X \times X & \xleftarrow{\Delta_X} & X & \xrightarrow{\Delta_X} & X \times X \\ \text{id}_{X \times X} \downarrow & & \Delta_X \downarrow & & \text{id}_{X \times X} \downarrow \\ X \times X & \xleftarrow{\text{id}_{X \times X}} & X \times X & \xrightarrow{\text{id}_{X \times X}} & X \times X \end{array}$$

Notice that here the top row of the diagram arises from the fiber product composition of correspondences given by

$$\begin{array}{c} X \times X \\ \swarrow p_1 \quad \searrow p_2 \\ X \times X \xleftarrow{\Delta} X \xrightarrow{\quad} * \xleftarrow{\quad} X \xrightarrow{\Delta} X \times X \end{array}$$

¹⁴The picture of the saddle here has been stolen from Aaron Lauda’s website. Thanks to Domenico Fiorenza and to Hisham Sati for lending a hand with the typesetting here.

The zig-zag identity for these

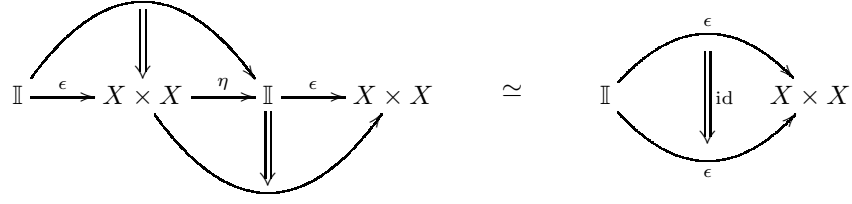

is indeed satisfied, as exhibited by the equivalence of following diagram in \mathbf{H} , formed from pasting the above diagrams,

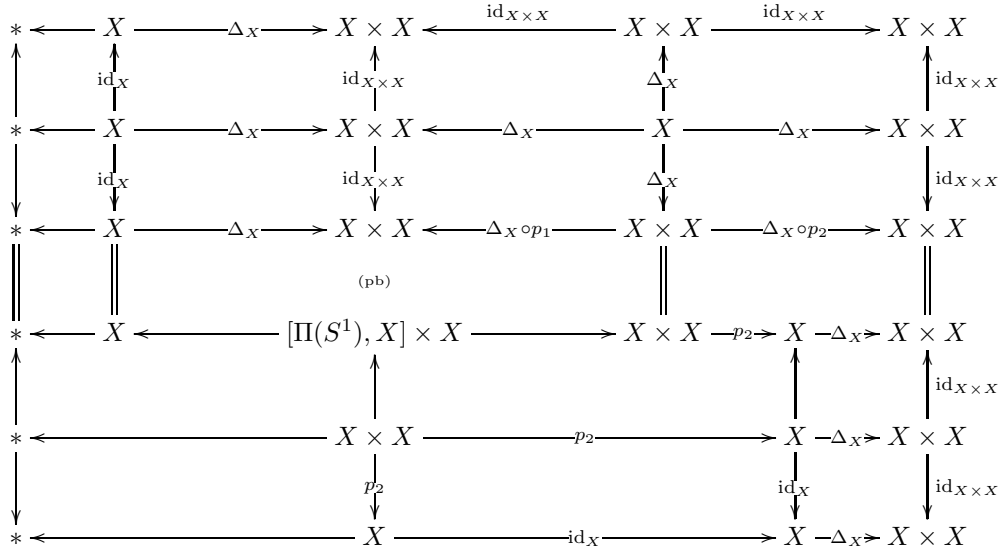

with the “vertical identity” 2-correspondence

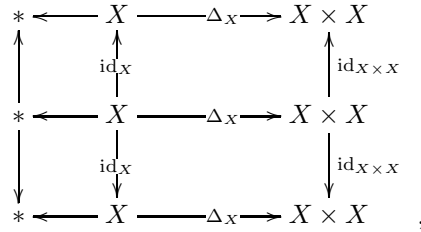

by the universal property of the homotopy pullback enjoyed by $[\Pi(S^1), X]$. Checking of the other zig-zag identities is completely analogous.

In this fashion we proceed by induction. The k -fold units and their adjoints are given in \mathbf{H} by k -fold correspondences of correspondences with tips given by

$$* \longleftarrow X \longrightarrow [\Pi(S^k), X] \quad \text{and} \quad [\Pi(S^k), X] \longleftarrow X \longrightarrow *$$

By proposition 4.4.32 the k -fold trace on the identity then is indeed

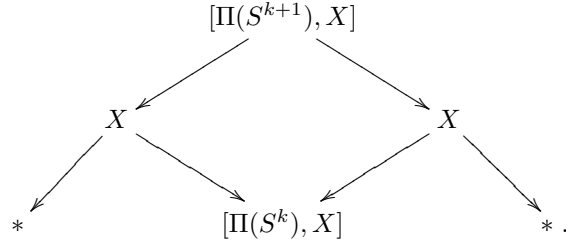

□

By the classification of local topological field theories [L-TFT] we, therefore, have the following

Proposition 3.9.112. *Fully extended topological field theory with coefficients in $\text{Corr}_n(\mathbf{H})$ are equivalent to objects $\mathbf{Fields} \in \mathbf{H}$*

$$Z_{\mathbf{Fields}} : \text{Bord}_n^\otimes \longrightarrow \text{Corr}_n(\mathbf{H})^\otimes ,$$

via $Z_{\mathbf{Fields}}(*) \cong \mathbf{Fields}$.

Therefore we will mostly just write this as

$$\mathbf{Fields} : \text{Bord}_n^\otimes \longrightarrow \text{Corr}_n(\mathbf{H})^\otimes ,$$

for short.

Remark 3.9.113. By handle decomposition of smooth manifolds it follows that the symmetric monoidal functor \mathbf{Fields} sends a closed manifold Σ_k of dimension k to the mapping stack $[\Pi(\Sigma_k), \mathbf{Fields}]$, seen as a k -fold correspondence of correspondences between the terminal object and itself. Generally, a cobordism Σ with incoming boundary Σ_{in} and outgoing boundary Σ_{out} is sent to the correspondence

$$(\Sigma_{\text{in}} \hookrightarrow \Sigma \hookleftarrow \Sigma_{\text{out}}) \longmapsto \left(\begin{array}{ccc} & [\Pi(\Sigma), \mathbf{Fields}] & \\ \swarrow^{(-)|_{\text{in}}} & & \searrow^{(-)|_{\text{out}}} \\ [\Pi(\Sigma_{\text{in}}), \mathbf{Fields}] & & [\Pi(\Sigma_{\text{out}}), \mathbf{Fields}] \end{array} \right)$$

in \mathbf{H} .

3.9.14.3 Local action functionals for the bulk field theory In addition to field configurations, prequantum field theory encodes the local *action functionals* or *Lagrangians* on these. This involves equipping all the objects described above with maps to a given space “of phases”, a suitable higher version of the group $U(1)$ in which traditional action functionals take values. For instance, in the introduction we considered Lagrangians of the form $\mathbf{L} : \mathbf{Fields} \rightarrow \mathbf{B}^n U(1)_{\text{conn}}$, in which the space of phases was the n -stack of $U(1)$ n -bundles with connection. More generally, we will choose the space of phases to be a commutative group object \mathbf{Phases} in \mathbf{H} . Clearly, since we are working in a higher categorical setting, “commutative” here means “commutative up to coherent homotopies”, and the same consideration applies to the group structure of the space of phases. That is \mathbf{Phases} is an E_∞ -group object in \mathbf{H} .

Remark 3.9.114. The fact that here we consider \mathbf{Phases} to be group object in \mathbf{H} instead of in a more general stack of symmetric monoidal (∞, n) -categories is related to the fact that here we are considering pre-quantum field theory as opposed to quantum field theory. For the latter one chooses a representation $\mathbf{Phases} \rightarrow \mathcal{C}$ of the space of phases on a genuine (∞, n) -category and postcomposes the Lagrangian with this, see [Nui13].

The general mechanism to describe local action functionals is based on the following simple observation.

Remark 3.9.115. The commutative group structure on \mathbf{Phases} endows the slice topos $\mathbf{H}/\mathbf{Phases}$ with a natural tensor product lifting the cartesian product of \mathbf{H} by

$$\left[\begin{array}{c} X \\ \downarrow F_1 \\ B \end{array} \right] \otimes \left[\begin{array}{c} Y \\ \downarrow F_2 \\ B \end{array} \right] := \left[\begin{array}{c} X \times Y \\ \downarrow \pi_X^* F_1 + \pi_Y^* F_2 \\ \mathbf{Phases} \end{array} \right] := \left[\begin{array}{c} X \times Y \\ \downarrow (\pi_X^* F_1, \pi_Y^* F_2) \\ \mathbf{Phases} \times \mathbf{Phases} \\ \downarrow + \\ \mathbf{Phases} \end{array} \right],$$

where on the right we use the group structure on \mathbf{Phases} . Here π_X and π_Y are the corresponding projections. The tensor unit is the unit inclusion:

$$\mathbb{I} = \left[\begin{array}{c} * \\ \downarrow 0 \\ \mathbf{Phases} \end{array} \right].$$

We can therefore lift Definition 3.9.108 and Remark 3.9.109 from fields to fields equipped with action functionals as follows.

Definition 3.9.116. The symmetric monoidal (∞, n) -category $\text{Corr}_n(\mathbf{H}/\mathbf{Phases})^\otimes$ is the (∞, n) -category structure on the ∞ -groupoid of functors from Corr_n to $\mathbf{H}/\mathbf{Phases}$ with compositions of correspondences by fiber product of maps to a common face; and with symmetric monoidal product induced by the symmetric monoidal category structure on $\mathbf{H}/\mathbf{Phases}$ described in Remark 3.9.115.

Remark 3.9.117. When $\mathbf{H} = \infty\text{Grpd}$ (geometrically discrete ∞ -groupoids), and for $\mathbf{Phases} \in \infty\text{Grpd}$ any ∞ -groupoid equipped with symmetric group structure, then we may regard this equivalently as a symmetric monoidal (∞, n) -category whose underlying (∞, n) -category happens to be an $(\infty, 0)$ -category. Therefore $\text{Corr}_n(\infty\text{Grpd}/\mathbf{Phases})$ in this case is an example of the class of (∞, n) -categories considered in [L-TFT] around prop. 3.2.8 there. Notice that when \mathbf{H} is not the canonical ∞ -topos ∞Grpd of geometrically discrete ∞ -groupoids, then the analogous generalization would allow \mathcal{C} to be not just a bare (∞, n) -category, but an (∞, n) -category internal to \mathbf{H} , hence a stack of (∞, n) -categories on an ∞ -site of definition for \mathbf{H} .

Notice that the forgetful morphism $\mathbf{H}/\mathbf{Phases} \rightarrow \mathbf{H}$, which forgets the map to the space of phases, induces a natural forgetful monoidal contravariant functor

$$\text{Corr}_n(\mathbf{H}/\mathbf{Phases})^\otimes \longrightarrow \text{Corr}_n(\mathbf{H})^\otimes.$$

Thanks to the commutative group structure on the space of phases, we have the following generalization of Proposition 3.9.111.

Proposition 3.9.118. *Every object $\mathbf{L} : X \rightarrow \mathbf{Phases}$ in $\text{Corr}_n(\mathbf{H}/\mathbf{Phases})^\otimes$ is fully dualizable, the full dual being $-\mathbf{L}$.*

Proof. Observe that we may take the co-evaluation map $\mathbb{I} \rightarrow \mathbf{L} \otimes (-\mathbf{L})$ and evaluation map $\mathbf{L} \otimes (-\mathbf{L}) \rightarrow \mathbb{I}$ to be given by

$$\begin{array}{ccc} \begin{array}{ccc} X & & \\ \swarrow & \Delta_X & \searrow \\ * & & X \times X \\ \searrow 0 & & \swarrow p_1^* \mathbf{L} - p_2^* \mathbf{L} \\ & & \mathbf{Phases} \end{array} & \text{and} & \begin{array}{ccc} & X & \\ \Delta_X \swarrow & & \searrow \\ X \times X & & * \\ \swarrow p_1^* \mathbf{L} - p_2^* \mathbf{L} & & \searrow 0 \\ & & \mathbf{Phases} \end{array}, \end{array}$$

respectively. Here p_1 and p_2 denote projection to the first and second factors, respectively, and the squares are filled by the canonical equivalence $p_1 \circ \Delta_X \cong p_2 \circ \Delta_X$. From here on the argument proceeds just as in the proof of Proposition 3.9.111. \square

Therefore we have the following analogue of Proposition 3.9.112.

Proposition 3.9.119. *A morphism $\mathbf{L} : \mathbf{Fields} \rightarrow \mathbf{Phases}$ in \mathbf{H} equivalently determines a fully extended topological field theory with coefficients in $\text{Corr}_n(\mathbf{H}/\mathbf{Phases})$,*

$$\exp\left(\frac{i}{\hbar} S_{\mathbf{L}}\right) : \text{Bord}_n^{\otimes} \rightarrow \text{Corr}_n(\mathbf{H}/\mathbf{Phases})^{\otimes},$$

characterized by the condition $\exp\left(\frac{i}{\hbar} S_{\mathbf{L}}\right)(*) \simeq \mathbf{L}$.

Definition 3.9.120. In view of the fully extended TQFT it defines, we call a morphism $\mathbf{L} : \mathbf{Fields} \rightarrow \mathbf{Phases}$ a *local action functional* or *local Lagrangian* for the TQFT with \mathbf{Fields} as stack of fields. Notice how the notion of local action and local Lagrangian unify here: the local Lagrangian is value of the local (extended) action functional on the point.

Remark 3.9.121. Since fully extended topological field theories are completely determined by their value on the point, a local action functional on a prescribed moduli stack of fields \mathbf{Fields} is equivalent to the datum of a symmetric monoidal lift

$$\begin{array}{ccc} & \text{Corr}_n(\mathbf{H}/\mathbf{Phases}) & \\ \exp\left(\frac{i}{\hbar} S_{\mathbf{L}}\right) \nearrow & \downarrow & \\ \text{Bord}_n & \xrightarrow{\mathbf{Fields}} & \text{Corr}_n(\mathbf{H}) \end{array}$$

This is the perspective in section 3 of [FHLT09] from field theories with geometrically discrete to those with cohesively geometric moduli stacks of fields.

Example 3.9.122. Given a local action functional $\exp\left(\frac{i}{\hbar} S_{\mathbf{L}}\right)$ as in prop. 3.9.119, then to the circle S^1 , regarded as a 1-morphism in Bord_n , is assigned the following correspondence in $\mathbf{H}/\mathbf{Phases}$

$$\begin{array}{ccccc} & & [\Pi(S^1), \mathbf{Fields}] & & \\ & \swarrow & & \searrow & \\ & \mathbf{Fields} & & \mathbf{Fields} & \\ & \swarrow & \text{(pb)} & \searrow & \\ * & & \mathbf{Fields} \times \mathbf{Fields} & & * \\ & \swarrow & \downarrow p_1^* \mathbf{L} - p_2^* \mathbf{L} & \searrow & \\ & * & \mathbf{Phases} & & * \end{array}$$

where the top two morphisms are restrictions to the left and right semicircles (hemispheres) of S^1 which are both homotopic to the point. By the universal property of the pullback, this induces a morphism

$$[\Pi(S^1), \mathbf{Fields}] \rightarrow \Omega \mathbf{Phases},$$

into the loop space object of the stack \mathbf{Phases} of higher phases. Notice that since \mathbf{Phases} is an abelian group object in \mathbf{H} then so is $\Omega \mathbf{Phases}$.

Unwinding this in components shows that the displayed homotopy in the middle exhibits the circle by two semi-circles that start and end at the same point. The whiskering with the vertical map evaluates the action functional on the first semi-circle and minus the action functional on the second, hence evaluates the action functional itself on one full copy of the circle. So this is the transgression of the Lagrangian to an action functional on the loop space.

3.9.14.4 Boundary field theory We now turn to the discussion of boundary data for a local prequantum field theory.

Notice that the cobordism theorem in the version of theorem 2.4.6 in [L-TFT] essentially says that Bord_n^\otimes is the symmetric monoidal (∞, n) -category with fully dualizable objects which is freely generated from a single object:

$$\text{Bord}_n \simeq \text{FreeSMD}(\{*\}).$$

Under this equivalence that single object is indeed identified with the manifold \mathbb{R}^0 , which in the above discussion is what locally supports a *bulk field theory*. But theorem 4.3.11 in [L-TFT] provides a considerable generalization of this situation. This theorem essentially says that for any collection of (∞, n) -categorical generating cells, there is a notion of smooth manifolds *with singularities* such that the (∞, n) -category $\text{Bord}_n^{\text{sing}\otimes}$ of n -dimensional cobordisms of manifolds with such singularities is the symmetric monoidal (∞, n) -category with fully dualizable objects which is free on the given collection of cells.

We consider this now for a singularity that corresponds to a 1-morphism of the form

$$\emptyset \longrightarrow *,$$

hence a morphism from the tensor unit to a generating object. Regarded as a cobordism, this is going to be interpreted as a cobordism that is much like the edge $[0, 1] : * \longrightarrow *$, only that to the left it is not possible to sew further edges to this. Hence under the cobordism theorem for manifolds with singularities, the above 1-cell is interpreted as a cobordism of the form

$$\begin{array}{c} | \\ \hline \longrightarrow * \end{array},$$

hence by a 1-dimensional cobordism that has a constrained boundary on the left.

Definition 3.9.123. Write

$$\text{Bord}_n^{\partial\otimes} := \text{FreeSMD}(\{\emptyset \rightarrow *\})$$

for the symmetric monoidal ∞ -category of cobordisms of manifolds with codimension-1 boundaries, corresponding to the 1-cell datum $\{\emptyset \rightarrow *\}$ under theorem 4.3.11 in [L-TFT].

Notice that by free-ness and by construction, there is a canonical inclusion

$$\text{Bord}_n^\otimes \longrightarrow \text{Bord}_n^{\partial\otimes}$$

Definition 3.9.124. Let $\mathbf{Fields} : \text{Bord}_n^\otimes \rightarrow \text{Corr}_n(\mathbf{H})$ be a choice of bulk fields according to prop. 3.9.112, then a choice of *boundary fields* for these bulk fields is a choice of extension \mathbf{Fields}^∂ :

$$\begin{array}{ccc} \text{Bord}_n^\otimes & \xrightarrow{Z_{\mathbf{Fields}}} & \text{Corr}_n(\mathbf{H})^\otimes \\ \downarrow & \nearrow Z_{\mathbf{Fields}^\partial} & \\ \text{Bord}_n^{\partial\otimes} & & \end{array} .$$

The following immediate consequence is worth recording.

Proposition 3.9.125. A choice of boundary fields for \mathbf{Fields} is equivalently a choice of moduli stack $\mathbf{Fields}_\partial \in \mathbf{H}$ together with a choice of morphism

$$\mathbf{Fields}_\partial \rightarrow \mathbf{Fields}$$

in \mathbf{H} .

Proof. Since Bord_n^∂ is free symmetric monoidal with duals on a single morphism out of the unit object, a symmetric monoidal functor $\text{Bord}_n^{\partial \otimes} \rightarrow \text{Corr}_n(\mathbf{H})$ is equivalent to the datum of a 1-morphism in $\text{Corr}_n(\mathbf{H})$ out of $*$. Requiring this to be an extension of the bulk fields amounts to asking that this 1-morphism in $\text{Corr}_n(\mathbf{H})$ has target \mathbf{Fields} , and so it is a correspondence in \mathbf{H} of the form

$$* \longleftarrow \mathbf{Fields}_\partial \longrightarrow \mathbf{Fields} .$$

Since $*$ is the terminal object in \mathbf{H} , this is equivalent to the datum of the morphism $\mathbf{Fields}_\partial \rightarrow \mathbf{Fields}$. \square

Remark 3.9.126. Therefore we will write $(\mathbf{Fields}_\partial \rightarrow \mathbf{Fields})$ for $Z_{\mathbf{Fields}_\partial}$. Notice that hence the ∞ -category of boundary fields for given bulk \mathbf{Fields} is the slice ∞ -topos $\mathbf{H}/_{\mathbf{Fields}}$.

The boundary field theory version of remark 3.9.113 about the bulk field theory is now the following (this was pointed out by Domenico Fiorenza).

Proposition 3.9.127. *A boundary field assignment*

$$(\mathbf{Fields}_\partial \rightarrow \mathbf{Fields}) : (\text{Bord}_n^\partial)^\otimes \rightarrow \text{Corr}_n(\mathbf{H})^\otimes$$

sends cobordisms $(\partial\Sigma \hookrightarrow \Sigma) \in \text{Bord}_n^\partial$ with marked boundary $\partial\Sigma$ to

$$(\mathbf{Fields}_\partial \rightarrow \mathbf{Fields}) : (\partial\Sigma \hookrightarrow \Sigma) \mapsto [\Pi(\partial\Sigma), \mathbf{Fields}_\partial] \times_{[\Pi(\partial\Sigma), \mathbf{Fields}]} [\Pi(\Sigma), \mathbf{Fields}] ,$$

hence to the stack of diagrams in \mathbf{H} of the form

$$\begin{array}{ccc} \Pi(\partial\Sigma) & \xrightarrow{\phi_\partial} & \mathbf{Fields}_\partial . \\ \downarrow & & \downarrow \\ \Pi(\Sigma) & \xrightarrow{\phi} & \mathbf{Fields} . \end{array}$$

Proof. Every cobordism Σ with marked boundary component $\partial\Sigma$ decomposes as the gluing of the cylinder $(\text{---}*) \times \partial\Sigma$ with Σ regarded as a manifold with unmarked boundary. Since $\text{---}*$ is mapped to the correspondence

$$* \longleftarrow \mathbf{Fields}_\partial \longrightarrow \mathbf{Fields}$$

in \mathbf{H} , we find that $(\text{---}*) \times \partial\Sigma$ is mapped to

$$* \longleftarrow [\Pi(\partial\Sigma), \mathbf{Fields}_\partial] \longrightarrow [\Pi(\partial\Sigma), \mathbf{Fields}] .$$

On the other hand, on the “piece” given by Σ with unmarked boundary $\partial\Sigma$ the field theory reduces to the one associated with the stack \mathbf{Fields} , and we know from Remark 3.9.113 that $\partial\Sigma \hookrightarrow \Sigma$ is mapped by \mathbf{Fields} to

$$[\Pi(\partial\Sigma), \mathbf{Fields}] \longleftarrow [\Pi(\Sigma), \mathbf{Fields}] \longrightarrow * .$$

The composite of these two contributions is

$$* \longleftarrow [\Pi(\partial\Sigma), \mathbf{Fields}_\partial] \times_{[\Pi(\partial\Sigma), \mathbf{Fields}]} [\Pi(\Sigma), \mathbf{Fields}] \longrightarrow * ,$$

as claimed. \square

Remark 3.9.128 (twisted relative cohomology). In words this says that for the boundary field theory $\mathbf{Fields}_\partial \rightarrow \mathbf{Fields}$, a field configurations on a manifold Σ with constrained boundary $\partial\Sigma$ is a bulk field configuration on Σ together with a boundary field configuration on $\partial\Sigma$ and an equivalence of the boundary field configuration with the restriction of the bulk field configuration to the boundary. These data are equivalently those of a *twisted cocycle* with local coefficient bundle $\mathbf{Fields}_\partial \rightarrow \mathbf{Fields}$, *relative* to the boundary inclusion. In particular, when $\mathbf{Fields}_\partial \simeq *$ then these are equivalently cocycles in *relative cohomology* with coefficients in \mathbf{Fields} .

We now add local action functionals with boundary conditions to the boundary fields.

Definition 3.9.129. Let $\exp(\frac{i}{\hbar}S) : \mathbf{Fields} \rightarrow \mathbf{Phases}$ be a local action functional for a bulk prequantum field theory according to prop. 3.9.119, then a *boundary condition* (or *boundary extension*) for \mathbf{L} is an extension

$$\begin{array}{ccc} \mathbf{Bord}_n^\otimes & \xrightarrow{\exp(\frac{i}{\hbar}S_{\mathbf{L}})} & \mathbf{Corr}_n(\mathbf{H}/\mathbf{Phases})^\otimes, \\ \downarrow & \nearrow & \\ \mathbf{Bord}_n^{\partial\otimes} & \xrightarrow{\exp(\frac{i}{\hbar}S_{\mathbf{L}}^\partial)} & \end{array}$$

Proposition 3.9.130. A boundary condition for a local Lagrangian \mathbf{L} with respecto to boundary fields $\mathbf{Fields}_\partial \rightarrow \mathbf{Fields}$ is equivalently a choice of homotopy in

$$\left(\begin{array}{c} \text{---} * \end{array} \right) \mapsto \begin{array}{ccc} & \mathbf{Fields}_\partial & \\ & \swarrow & \searrow \\ * & & \mathbf{Fields} \\ & \searrow & \swarrow \\ & \mathbf{Phases} & \end{array} \begin{array}{l} \\ \\ \\ \exp(\frac{i}{\hbar}S_{\mathbf{L}}) \end{array}$$

in \mathbf{H} , which in turn is equivalently a choice of morphism

$$\mathbf{Fields}_\partial \rightarrow \text{fib}(\mathbf{L})$$

in \mathbf{H} , where $\text{fib}(\mathbf{L})$ is the homotopy fiber of $\mathbf{L} : \mathbf{Fields} \rightarrow \mathbf{Phases}$ on the zero element of the commutative group stack of phases.

Proof. Since \mathbf{Bord}_n^\otimes is free symmetric monoidal with duals on a single morphism out of the unit object, a symmetric monoidal functor $\exp(\frac{i}{\hbar}S_{\mathbf{L}}^\partial)$ is equivalent to the datum of a 1-morphism in $\mathbf{Corr}_n(\mathbf{H}/\mathbf{Phases})$ out of $* \xrightarrow{0} \mathbf{Phases}$. \square

Therefore we set:

Definition 3.9.131. The ∞ -category of boundary conditions for $\mathbf{L} : \mathbf{Fields} \rightarrow \mathbf{Phases}$ is the slice ∞ -topos $\mathbf{H}/\text{fib}(\mathbf{L})$. For $n \in \mathbb{N}$ and $\exp(\frac{i}{\hbar}S_{\mathbf{L}}) \in \mathbf{H}/\mathbf{Phases}$, we call

$$\text{Bdr}(\exp(\frac{i}{\hbar}S_{\mathbf{L}})) := \mathbf{Corr}_1(\mathbf{H}/\mathbf{Phases})(0, \exp(\frac{i}{\hbar}S_{\mathbf{L}}))$$

the ∞ -category of boundary conditions of the local action functional $\exp(\frac{i}{\hbar}S_{\mathbf{L}})$.

Definition 3.9.132. For $\exp(\frac{i}{\hbar}S_{\mathbf{L}})$ a local bulk prequantum field theory, by prop. 3.9.119, we say that its *universal boundary condition* is that which is given via remark 3.9.130 by the square exhibiting the homotopy

fiber of S in \mathbf{H}

$$\begin{array}{ccc}
 & \text{fib}(\exp(\frac{i}{\hbar}S)) & \\
 & \swarrow & \searrow \\
 * & & \mathbf{Fields} \\
 & \searrow & \swarrow \\
 & \mathfrak{b}\mathbf{B}^n U(1) & \\
 & \swarrow & \searrow \\
 & 0 & \exp(\frac{i}{\hbar}S)
 \end{array}$$

The following immediate consequence is relevant.

Proposition 3.9.133. *The universal boundary condition is the terminal object in the ∞ -category $\text{Bdr}(\exp(\frac{i}{\hbar}S_{\mathbf{L}}))$ of boundary conditions, def. 3.9.131. A general boundary condition with moduli stack $\mathbf{Fields}_{\partial}$ is equivalently a morphism $\mathbf{Fields}_{\partial} \rightarrow \text{fib}(\exp(iS))$: there is a natural equivalence*

$$\text{Bdr}(\exp(\frac{i}{\hbar}S)) \simeq \mathbf{H}_{/\text{fib}(\exp(\frac{i}{\hbar}S))}$$

between the ∞ -category of boundary conditions for $\exp(iS)$ and the slice ∞ -topos of \mathbf{H} over $\text{fib}(\exp(iS))$.

Proof. The ∞ -category $\text{Bdr}(\exp(\frac{i}{\hbar}S_{\mathbf{L}}))$ is equivalently the ∞ -category of cones over the diagram $0\mathcal{V}_{\exp(iS)} : \text{cosp} \rightarrow \mathbf{H}$ from the free cospan category which exhibits the diagram

$$\left\{ \begin{array}{ccc}
 * & & \mathbf{Fields} \\
 & \searrow & \swarrow \\
 & 0 & \exp(iS) \\
 & & \mathfrak{b}\mathbf{B}^n U(1)
 \end{array} \right\}.$$

In the notation of section 1.2.9 [L-Topos] this means

$$\text{Bdr}(\exp(\frac{i}{\hbar}S_{\mathbf{L}})) \simeq \mathbf{H}_{/(0\mathcal{V}_{\exp(\frac{i}{\hbar}S_{\mathbf{L}})})}$$

Let then $* \hookrightarrow \square \longleftarrow \text{cosp}$ be the inclusion of the point as the initial object of the box-shaped diagram ∞ -category

$$\square = \left\{ \begin{array}{ccc}
 0 & \longrightarrow & 01 \\
 \downarrow & \swarrow & \downarrow \\
 10 & \longrightarrow & 11
 \end{array} \right\},$$

and the inclusion of the underlying cospan, respectively. Let then $0\widehat{\mathcal{V}}_{\exp(iS)} : \square \rightarrow \mathbf{H}$ be the homotopy pullback diagram that exhibits the homotopy fiber $\text{fib}(\exp(iS))$ and write $0\mathcal{V}_{\exp(iS)} : \text{cosp} \rightarrow \mathbf{H}$ for its restriction to the underlying cospan, as in remark 3.9.133. This induces a diagram of ∞ -functors

$$\mathbf{H}_{/\text{fib}(\exp(iS))} \xleftarrow{\simeq} \mathbf{H}_{/0\widehat{\mathcal{V}}_{\exp(iS)}} \xrightarrow{\simeq} \mathbf{H}_{/0\mathcal{V}_{\exp(iS)}} \simeq \text{Bdr}(\exp(iS)).$$

The equivalence on the far right is that of remark 3.9.133. The functor in the middle is an equivalence by finality of the ∞ -limiting cones, as for instance in the proof of prop. 1.2.13.8 in [L-Topos]. And finally – since the inclusion of an initial object is an op-final ∞ -functor by prop. 4.1.3.1 in [L-Topos] – also the left functor, being the restriction of slices along an op-final functor, is an equivalence, by prop. 4.1.1.8 in [L-Topos]. \square

3.9.14.5 Corner field theory We now consider singularities of codimension 2 at which two boundaries of codimension 1 meet, a *corner* singularity.

Definition 3.9.134. Write

$$\text{Bord}_n^{\partial_1 \partial_2 *} := \text{FreeSMD} \left(\left(\begin{array}{c} \text{---} * \\ \text{---} * \end{array} \right) \times \left(\begin{array}{c} - \\ \downarrow \\ * \end{array} \right) : \begin{array}{ccc} \emptyset & \xrightarrow{\text{id}} & \emptyset \\ \text{id} \downarrow & & \downarrow \\ \emptyset & \longrightarrow & * \end{array} \right)$$

for the symmetric monoidal (∞, n) -category with fully dualizable objects which is free on a 2-cell as show on the right, considered as the (∞, n) -category of cobordisms with two types of marked codimension-1 boundaries and one kind of corner between these, by theorem 4.3.11 in [L-TFT].

As an immediate consequence, we have:

Proposition 3.9.135. A symmetric monoidal (∞, n) -functor

$$Z_{\mathbf{Fields}_{\partial_1 \partial_2}} : (\text{Bord}_n^{\partial_1 \partial_2 *})^{\otimes} \longrightarrow \text{Corr}_n(\mathbf{H})^{\otimes}$$

is equivalently the datum of

1. a moduli stack $\mathbf{Fields} \in \mathbf{H}$ of bulk fields;
2. two moduli stacks $\mathbf{Fields}_{\partial_1}, \mathbf{Fields}_{\partial_2}$ of boundary fields;
3. a moduli stack $\mathbf{Fields}_{\partial_1 \partial_2}$ of corner fields or defect fields;
4. a homotopy diagram

$$\begin{array}{ccc} \mathbf{Fields}_{\partial_1 \partial_2} & \longrightarrow & \mathbf{Fields}_{\partial_1} \\ \downarrow & \swarrow \simeq & \downarrow \\ \mathbf{Fields}_{\partial_2} & \longrightarrow & \mathbf{Fields} \end{array}$$

in \mathbf{H} .

A lift of that to correspondences in the slice

$$\begin{array}{ccc} (\text{Bord}_n^{\partial_1 \partial_2 *})^{\otimes} & \xrightarrow{\exp\left(\frac{i}{\hbar} S_L\right)} & \text{Corr}_n(\mathbf{H}/\text{Phases})^{\otimes} \\ & \searrow Z_{\mathbf{Fields}_{\partial_1 \partial_2}} & \downarrow \\ & & \text{Corr}_n(\mathbf{H})^{\otimes} \end{array}$$

is a choice of extension of the above homotopy commutative diagram in \mathbf{H} as

Remark 3.9.136. This means that for two boundary conditions which are given by relative boundary trivializations of their local action functionals as in the previous section, a corner defect condition for them is a further homotopy between the pullback of these two trivializations to the moduli stack of corner field configurations.

3.9.14.6 Defect field theory Finally, let us sketch a few lines on general pre-quantum defect field theory (see for instance [DKR11] for general considerations about extended defect field theory). These correspond to adding another piece to the picture of framed cobordism, namely that of a punctured k -disk, seen as a morphism from the vacuum to the $(k - 1)$ -sphere. In more formal terms, since a k -disk is homotopically trivial, this amounts to the following.

Definition 3.9.137. Given a bulk field \mathbf{Fields} in \mathbf{H} , a codimension- k defect datum is a k -fold correspondence of the form

$$\mathbf{Fields}_{\text{ins}} \longleftarrow \mathbf{Fields}_{\text{def}} \longrightarrow [\Pi(S^{k-1}), \mathbf{Fields}] .$$

Examples of such defects and further comments on how to think of them appear as Example 5.7.20 and Example 5.7.25 below.

3.10 Structures in a differentially cohesive ∞ -topos

We discuss a list of differential geometric notions that can be formulated in the presence of the axioms for infinitesimal cohesion, 3.9. These structures parallel the structures in a general cohesive ∞ -topos, 3.9.

- 3.10.1 – Infinitesimal path ∞ -groupoid and de Rham spaces;
- 3.10.2 – Crystalline cohomology, flat infinitesimal ∞ -connections and local systems;
- 3.10.3 – Jet ∞ -bundles;
- 3.10.4 – Infinitesimal Galois theory / Formally étale morphisms;
- 3.10.5 – Formally étale groupoids;
- 3.10.6 – Manifolds (separated);
- 3.10.8 – Critical loci, variational calculus and BV-BRST complexes;
- 3.10.9 – Formal cohesive ∞ -groupoids.

3.10.1 Infinitesimal path ∞ -groupoid and de Rham spaces

We discuss the infinitesimal analog of the *path ∞ -groupoid*, 3.8.3, which exists in a context of infinitesimal cohesion, def. 3.5.1.

Let $(i_! \dashv i^* \dashv i_* \dashv i^!): \mathbf{H} \rightarrow \mathbf{H}_{\text{th}}$ be an infinitesimal neighbourhood of a cohesive ∞ -topos.

Definition 3.10.1. Write

$$(\mathbf{Red} \dashv \mathbf{\Pi}_{\text{inf}} \dashv \mathbf{b}_{\text{inf}}) : (i_! i^* \dashv i_* i^* \dashv i_* i^!) : \mathbf{H}_{\text{th}} \rightarrow \mathbf{H}_{\text{th}}$$

for the adjoint triple induced by the adjoint quadruple that defines the differential cohesion. For $X \in \mathbf{H}_{\text{th}}$ we say that

- $\mathbf{\Pi}_{\text{inf}}(X)$ is the *infinitesimal path ∞ -groupoid* of X ;

The $(i^* \dashv i_*)$ -unit

$$X \rightarrow \mathbf{\Pi}_{\text{inf}}(X)$$

we call the *constant infinitesimal path inclusion*.

- $\mathbf{Red}(X)$ is the *reduced cohesive ∞ -groupoid* underlying X .

The $(i_* \dashv i^!)$ -counit

$$\mathbf{Red}X \rightarrow X$$

we call the *inclusion of the reduced part* of X .

Remark 3.10.2. This is an abstraction of the setup considered in [SiTe]. In traditional contexts as considered there, the object $\mathbf{\Pi}_{\text{inf}}(X)$ is called the *de Rham space* of X or the *de Rham stack* of X . Here we may tend to avoid this terminology, since by 3.9.3 we have a good notion of intrinsic de Rham cohomology in every cohesive ∞ -topos already without equipping it with infinitesimal cohesion, which, over some $X \in \mathbf{H}$ is co-represented by the object $\mathbf{\Pi}_{\text{dR}}(X)$, the cohesive de Rham homotopy type of remark 3.9.19. On the other hand, $\mathbf{\Pi}_{\text{inf}}$ co-represents instead what is called *crystalline cohomology*, 3.10.2 below.

Proposition 3.10.3. *In the notation of def. 3.5.4, there is a canonical natural transformation*

$$\mathbf{\Pi}_{\text{inf}}(X) \rightarrow \mathbf{\Pi}(X)$$

that factors the finite path inclusion through the infinitesimal path inclusion

$$\begin{array}{ccc} & & \mathbf{\Pi}_{\text{inf}}(X) \\ & \nearrow & \downarrow \\ X & \longrightarrow & \mathbf{\Pi}(X) \end{array} .$$

Dually there is a canonical natural transformation

$$\flat A \rightarrow \flat A$$

that factors the \flat -counits

$$\begin{array}{ccc} \flat A & & \\ \downarrow & \searrow & \\ \flat_{\text{inf}} A & \longrightarrow & A \end{array} .$$

Proof. By def. 3.5.4 this is just the formula for the unit of the composite adjunction

$$(\mathbf{\Pi}_{\mathbf{H}_{\text{th}}} \dashv \flat_{\mathbf{H}_{\text{th}}}) : \mathbf{H}_{\text{th}} \begin{array}{c} \xrightarrow{\mathbf{\Pi}_{\text{inf}}} \\ \xleftarrow{\text{Disc}_{\text{inf}}} \end{array} \mathbf{H} \begin{array}{c} \xrightarrow{\mathbf{\Pi}} \\ \xleftarrow{\text{Disc}} \end{array} \infty\text{Grpd} ,$$

more explicitly given by

$$\begin{array}{ccc} & & \text{Disc}_{\text{inf}} \circ \mathbf{\Pi}_{\text{inf}}(X) \\ & \nearrow & \downarrow \\ X & \longrightarrow & \text{Disc}_{\text{inf}} \circ \text{Disc}_{\mathbf{H}} \circ \mathbf{\Pi}_{\mathbf{H}} \circ \mathbf{\Pi}_{\text{inf}}(X) \end{array} .$$

The case for \flat is formally dual. □

3.10.2 Crystalline cohomology, flat infinitesimal connections and local systems

Definition 3.10.4. For $X \in \mathbf{H}_{\text{th}}$ an object, we call the cohomology, def. 3.6.134 of $\mathbf{\Pi}_{\text{inf}}(X)$ the *crystalline cohomology* of X .

We discuss now the infinitesimal analog of intrinsic flat cohomology, 3.8.5.

Definition 3.10.5. For $X \in \mathbf{H}_{\text{th}}$ an object, we call the cohomology, def. 3.6.134 of $\mathbf{\Pi}_{\text{inf}}(X)$ the *crystalline cohomology* of X . More specifically, for $A \in \mathbf{H}_{\text{th}}$ we say that

$$H_{\text{inflat}}(X, A) := \pi_0 \mathbf{H}(\mathbf{\Pi}_{\text{inf}}(X), A) \simeq \pi_0 \mathbf{H}(X, \flat_{\text{inf}} A)$$

is the *infinitesimal flat cohomology* of X with coefficient in A .

Remark 3.10.6. That traditional crystalline cohomology is the cohomology of the “de Rham stack”, see remark 3.10.2 above with coefficients in a suitable stack is discussed in [L-DGeo], above theorem 0.4. The relation to de Rham cohomology in traditional contexts is discussed for instance in [SiTe].

Remark 3.10.7. By observation 3.10.3 we have canonical natural morphisms

$$\mathbf{H}_{\text{flat}}(X, A) \rightarrow \mathbf{H}_{\text{infflat}}(X, A) \rightarrow \mathbf{H}(X, A)$$

The objects on the left are principal ∞ -bundles equipped with flat ∞ -connection. The first morphism forgets their higher parallel transport along finite volumes and just remembers the parallel transport along infinitesimal volumes. The last morphism finally forgets also this connection information.

Definition 3.10.8. For $A \in \mathbf{H}_{\text{th}}$ a 0-truncated abelian ∞ -group object we say that the *de Rham theorem* for A -coefficients holds in \mathbf{H}_{th} if for all $X \in \mathbf{H}_{\text{th}}$ the infinitesimal path inclusion of observation 3.10.3

$$\mathbf{\Pi}_{\text{inf}}(X) \rightarrow \mathbf{\Pi}(X)$$

is an equivalence in A -cohomology, hence if for all $n \in \mathbb{N}$ we have that

$$\pi_0 \mathbf{H}_{\text{th}}(\mathbf{\Pi}(X), \mathbf{B}^n A) \rightarrow \pi_0 \mathbf{H}_{\text{th}}(\mathbf{\Pi}_{\text{inf}}(X), \mathbf{B}^n A)$$

is an isomorphism.

If we follow the notation of remark 3.10.6 and moreover write $|X| = |\mathbf{\Pi}X|$ for the intrinsic geometric realization, def. 3.8.2, then this becomes

$$H_{\text{dR,th}}^\bullet(X, A) \simeq H^\bullet(|X|, A_{\text{disc}}),$$

where on the right we have ordinary cohomology in Top (for instance realized as singular cohomology) with coefficients in the discrete group $A_{\text{disc}} := \Gamma A$ underlying the cohesive group A .

In certain contexts of infinitesimal neighbourhoods of cohesive ∞ -toposes the de Rham theorem in this form has been considered in [SiTe]. We discuss a realization below in 4.5.3.

3.10.3 Jet bundles

In the presence of infinitesimal cohesion there is a canonical higher analog notion of *jet bundles*: the generalization of tangent bundles to higher order infinitesimals (higher order tangents).

Definition 3.10.9. For any object $X \in \mathbf{H}$ write

$$\text{Jet} : \mathbf{H}_{/X} \begin{array}{c} \xleftarrow{i^*} \\ \xrightarrow{i_*} \end{array} \mathbf{H}/\mathbf{\Pi}_{\text{inf}}(X)$$

for the base change geometric morphism, prop. 3.6.13, induced by the constant infinitesimal path inclusion $i : X \rightarrow \mathbf{\Pi}_{\text{inf}}(X)$, def. 3.10.1.

For $(E \rightarrow X) \in \mathbf{H}_{/X}$ we call $\text{Jet}(E) \rightarrow \mathbf{\Pi}_{\text{inf}}(X)$ as well as its pullback $i^* \text{Jet}(E) \rightarrow X$ (if the context is clear) the *jet ∞ -bundle* of $E \rightarrow X$.

Remark 3.10.10. In the context over an algebraic site the construction of def. 3.10.9 reduces to the construction in section 2.3.2 of [BeDr04], see [Paug11] for a review.

3.10.4 Infinitesimal Galois theory / Formally étale morphisms

In every context of infinitesimal cohesion, there are canonical induced notions of morphisms being *formally étale*, meaning that at least on infinitesimal neighbourhoods of every point they behave like the analog of what in topology is a *local homeomorphism/étale map*. Close cousins of this are the notions of *formally smooth* and of *formally unramified* morphisms.

We first discuss formal étaleness in \mathbf{H} . Below in def. 3.10.19 we discuss the notion more generally in \mathbf{H}_{th} .

Definition 3.10.11. We say an object $X \in \mathbf{H}_{\text{th}}$ is *formally smooth* if the constant infinitesimal path inclusion, def. 3.10.1,

$$X \rightarrow \mathbf{\Pi}_{\text{inf}}(X)$$

is an effective epimorphism, def. 2.3.3.

Remark 3.10.12. In this form this is the direct ∞ -categorical analog of the characterization of formal smoothness in [SiTe]. The following equivalent reformulation corresponds in turn to the discussion in section 4.1 of [RoKo04].

Definition 3.10.13. Write

$$\phi : i_! \rightarrow i_*$$

for the canonical natural transformation given as the composite

$$i_! \xrightarrow{\eta_{i_!}} \mathbf{\Pi}_{\text{inf}} i_! \xrightarrow{:=} i_* i^* i_! \xrightarrow{\simeq} i_* .$$

Since the last composite on the right here is an equivalence due to $i_!$ being fully faithful we have:

Proposition 3.10.14. *An object $X \in \mathbf{H} \xrightarrow{i_!} \mathbf{H}_{\text{th}}$ is formally smooth according to def. 3.10.11 precisely if the canonical morphism*

$$\phi : i_! X \rightarrow i_* X$$

is an effective epimorphism.

Remark 3.10.15. In this form this characterization of formal smoothness is the evident generalization of the condition given in section 4.1 of [RoKo04]. (Notice that the notation there is related to the one used here by $u^* = i_!$, $u_* = i^*$ and $u^! = i_*$.)

Therefore with [RoKo04] we have the following more general definitions.

Definition 3.10.16. For $f : X \rightarrow Y$ a morphism in \mathbf{H} , we say that

1. f is a *formally smooth morphism* if the canonical morphism

$$i_! X \rightarrow i_! Y \prod_{i_* Y} i_* Y$$

is an effective epimorphism;

2. f is a *formally étale morphism* if this morphism is an equivalence, equivalently if the naturality square

$$\begin{array}{ccc} i_! X & \xrightarrow{i_! f} & i_! Y \\ \downarrow \phi_X & & \downarrow \phi_Y \\ i_* X & \xrightarrow{i_* f} & i_* Y \end{array}$$

is an ∞ -pullback square.

3. f is a *formally unramified morphism* if this is a (-1) -truncated morphism. More generally, f is an *order- k formally unramified morphism* for $(-2) \leq k \leq \infty$ if this is a k -truncated morphism ([L-Topos], 5.5.6).

Remark 3.10.17. An order- (-2) formally unramified morphism is equivalently a formally étale morphism. Only for 0-truncated X does formal smoothness together with formal unramifiedness imply formal étaleness.

Remark 3.10.18. The idea of characterizing étale morphisms with respect to a notion of *infinitesimal extension* as those making certain naturality squares into pullback squares goes back to lectures by André Joyal in the 1970s, as is recalled in the introduction of [Dub00]. Notice that in sections 3 and 4 there the analog of our functor $i_!$ is assumed to be the inverse image of a geometric morphism, whereas here we only require it to be a left adjoint and to preserve finite products, as opposed to all finite limits. Indeed, it will fail to preserve general pullbacks in most models for infinitesimal cohesion of interest, such as the one discussed below in 4.5. In [JoyMo94] a different kind of axiomatization, by way of closure properties. This we discuss further below, see remark 3.10.30.

The characterization of formal étaleness by cartesian naturality squares induced specifically by adjoint triples of functors, as in our def. 3.10.11, appears around prop. 5.3.1.1 of [RoKo04].

But in view of prop. 3.10.11, which applies to objects in \mathbf{H}_{th} not necessarily in the image of the inclusion $i_!$, and in view of def. 3.10.13 it is natural to generalize further:

Definition 3.10.19. A morphism $f : X \rightarrow Y$ in \mathbf{H}_{th} is a *formally étale morphism* if the naturality diagram

$$\begin{array}{ccc} X & \longrightarrow & \mathbf{\Pi}_{\text{inf}}(X) \\ \downarrow f & & \downarrow \mathbf{\Pi}_{\text{inf}}(f) \\ Y & \longrightarrow & \mathbf{\Pi}_{\text{inf}}(Y) \end{array}$$

of the infinitesimal path inclusion, def. 3.10.1, is an ∞ -pullback.

Remark 3.10.20. Def. 3.10.19 is compatible with def. 3.10.16 in that a morphism $f \in \mathbf{H}$ is formally étale in the sense of the former precisely if $i_!f \in \mathbf{H}_{\text{th}}$ is formally étale in the sense of the latter.

Remark 3.10.21. This condition is the immediate infinitesimal analog of the notion of $\mathbf{\Pi}$ -closure in def. 3.8.21: we may say equivalently that a morphism $f \in \mathbf{H}_{\text{th}}$ is formally étale precisely if it is $\mathbf{\Pi}_{\text{inf}}$ -closed. Moreover, by the discussion in 3.8.6 the $\mathbf{\Pi}$ -closed morphisms into some X are interpreted as the total space projections of *locally constant ∞ -stacks* over X by general abstract Galois theory. Accordingly here we may think of $\mathbf{\Pi}_{\text{inf}}$ -closed morphisms into X as total space projections of more general ∞ -stacks over X by what we may call general abstract *infinitesimal Galois theory*. This perspective we develop below in 3.10.7.

In particular, we have the following immediate infinitesimal analogs of properties of $\mathbf{\Pi}$ -closure.

Definition 3.10.22. Call a morphism $f : X \rightarrow Y$ in \mathbf{H}_{th} a $\mathbf{\Pi}_{\text{inf}}$ -equivalence if $\mathbf{\Pi}_{\text{inf}}(f)$ is an equivalence.

Proposition 3.10.23. For $i : \mathbf{H} \rightarrow \mathbf{H}_{\text{th}}$ a differentially cohesive ∞ -topos, the pair of classes of morphisms

$$(\mathbf{\Pi}_{\text{inf}}\text{-equivalences, formally étale morphisms}) \subset \text{Mor}(\mathbf{H}_{\text{th}}) \times \text{Mor}(\mathbf{H}_{\text{th}})$$

constitutes an orthogonal factorization system.

Proof. Since $\mathbf{\Pi}_{\text{inf}}$ has the left adjoint \mathbf{Red} it preserves all ∞ -pullbacks and hence in particular those over objects of the form $\mathbf{\Pi}_{\text{inf}}(X)$. Therefore factorization follows as in the proof of prop. 3.8.25. Accordingly, orthogonality follows as in the proof of prop. 3.8.26. \square

This and the fact that $\mathbf{\Pi}_{\text{inf}}$ preserves ∞ -limits implies a wealth of stability properties of formally étale maps.

Corollary 3.10.24. Formally étale morphisms in \mathbf{H}_{th} , def. 3.10.19, satisfy the following stability properties

1. Every equivalence is formally étale.
2. The composite of two formally étale morphisms is itself formally étale.

3. If

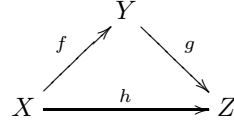

is a diagram such that g and h are formally étale, then also f is formally étale.

4. Any retract of a formally étale morphisms is itself formally étale.

5. The ∞ -pullback of a formally étale morphisms is formally étale.

But since the embedding functor $i_!$ does not preserve ∞ -limits in general, closure under pullback in \mathbf{H} requires a condition on the codomain:

Proposition 3.10.25. *The collection of formally étale morphisms in \mathbf{H} , def. 3.10.16, is closed under the following operations.*

1. Every equivalence is formally étale.

2. The composite of two formally étale morphisms is itself formally étale.

3. If

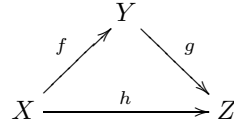

is a diagram such that g and h are formally étale, then also f is formally étale.

4. Any retract of a formally étale morphisms is itself formally étale.

5. The ∞ -pullback of a formally étale morphisms is formally étale if the pullback is preserved by $i_!$.

Remark 3.10.26. The statements about closure under composition and pullback appears as prop. 5.4, prop. 5.6 in [RoKo04]. The extra assumption that $i_!$ preserves the pullback is implicit in their setup.

Proof. The first statement follows trivially because ∞ -pullbacks are well defined up to equivalence. The second two statements follow by the pasting law for ∞ -pullbacks, prop. 2.3.2: let $f : X \rightarrow Y$ and $g : Y \rightarrow Z$ be two morphisms and consider the pasting diagram

$$\begin{array}{ccccc} i_!X & \xrightarrow{i_!f} & i_!Y & \xrightarrow{i_!g} & Z \\ \downarrow & & \downarrow & & \downarrow \\ i_*X & \xrightarrow{i_*f} & i_*Y & \xrightarrow{i_*g} & i_*Z \end{array} .$$

If f and g are formally étale then both small squares are pullback squares. Then the pasting law says that so is the outer rectangle and hence $g \circ f$ is formally étale. Similarly, if g and $g \circ f$ are formally étale then the right square and the total reactangle are pullbacks, so the pasting law says that also the left square is a pullback and so also f is formally étale.

For the fourth claim, let $\text{Id} \simeq (g \rightarrow f \rightarrow g)$ be a retract in he arrow ∞ -category \mathbf{H}^I . By applying the natural transformation $\phi : i_! \rightarrow i_*$ this becomes a retract

$$\text{Id} \simeq ((i_!g \rightarrow i_*g) \rightarrow (i_!f \rightarrow i_*f) \rightarrow (i_!g \rightarrow i_*g))$$

in the category of squares \mathbf{H}^\square . By assumption the middle square is an ∞ -pullback square and we need to show that the also the outer square is. This follows generally: a retract of an ∞ -limiting cone is itself ∞ -limiting. To see this, we invoke the presentation of ∞ -limits by *derivators* (thanks to Mike Shulman for this argument): we have

1. ∞ -limits in \mathbf{H} are computed by homotopy limits in an presentation by a model category $K := [C^{\text{op}}, \text{sSet}]_{\text{loc}} [\text{L-Topos}]$;
2. for $j : J \rightarrow J^\triangleleft$ the inclusion of a diagram into its cone (the join with an initial element), the homotopy limit over C is given by forming the right Kan extension $j_* : \text{Ho}(K^J(W^J)^{-1}) \rightarrow \text{Ho}(K^{J^\triangleleft}(W^{J^\triangleleft})^{-1})$,
3. a J^\triangleleft -diagram F is a homotopy limiting cone precisely if the unit

$$F \rightarrow j_* j^* F$$

us an isomorphism.

Therefore we have a retract in $[\Delta[1], [\square, K]]$

$$\begin{array}{ccccc} (i_!g \rightarrow i_!g) & \longrightarrow & (i_!f \rightarrow i_!f) & \longrightarrow & (i_!g \rightarrow i_!g) \\ \downarrow & & \downarrow & & \downarrow \\ j^* j_* (i_!g \rightarrow i_!g) & \longrightarrow & j^* j_* (i_!f \rightarrow i_!f) & \longrightarrow & j^* j_* (i_!g \rightarrow i_!g) \end{array} ,$$

where the middle morphism is an isomorphism. Hence so is the outer morphism and therefore also g is formally étale.

For the last claim, consider an ∞ -pullback diagram

$$\begin{array}{ccc} A \times_Y X & \longrightarrow & X \\ \downarrow p & & \downarrow f \\ A & \longrightarrow & Y \end{array}$$

where f is formally étale. Applying the natural transformation $\phi : i_! \rightarrow i_*$ to this yields a square of squares. Two sides of this are the pasting composite

$$\begin{array}{ccccc} i_!A \times_Y X & \longrightarrow & i_!X & \xrightarrow{\phi_X} & i_*X \\ \downarrow i_!p & & \downarrow i_!f & & \downarrow i_*f \\ i_!A & \longrightarrow & i_!Y & \xrightarrow{\phi_Y} & i_*Y \end{array}$$

and the other two sides are the pasting composite

$$\begin{array}{ccccc} i_!A \times_Y X & \xrightarrow{\phi_{A \times_Y X}} & i_*A \times_Y A & \longrightarrow & i_*X \\ \downarrow i_!p & & \downarrow i_*p & & \downarrow i_*f \\ i_!A & \xrightarrow{\phi_A} & i_*A & \longrightarrow & i_*Y \end{array} .$$

Counting left to right and top to bottom, we have that

- the first square is a pullback by assumption that $i_!$ preserves the given pullback;
- the second square is a pullback, since f is formally étale.
- the total top rectangle is therefore a pullback, by the pasting law;
- the fourth square is a pullback since i_* is right adjoint and so also preserves pullbacks;
- also the total bottom rectangle is a pullback, since it is equal to the top total rectangle;

- therefore finally the third square is a pullback, by the other clause of the pasting law. Hence p is formally étale. □

We consider now types of ∞ -pullbacks that are preserved by $i_!$.

Proposition 3.10.27. *If $U \twoheadrightarrow X$ is an effective epimorphism in \mathbf{H} that is addition formally étale, def. 3.10.16, then also its image $i_!U \rightarrow i_!X$ in \mathbf{H}_{th} is an effective epimorphism.*

Proof. Because i_* is left and right adjoint it preserves all small ∞ -limits and ∞ -colimits and therefore preserves effective epimorphisms. Since these are stable under ∞ -pullback, it follows by definition of formal étaleness that with $i_*U \rightarrow i_*X$ also $i_!U \rightarrow i_!X$ is an effective epimorphism. □

Proposition 3.10.28. *If in a differentially cohesive ∞ -topos $i : \mathbf{H} \hookrightarrow \mathbf{H}_{\text{th}}$ both \mathbf{H} as well as \mathbf{H}_{th} have an ∞ -cohesive site of definition, then the functor $i_!$ preserves pullbacks over discrete objects.*

Proof. Since it preserves finite products by assumption, the claim follows as in the proof of theorem 3.8.19. □

Proposition 3.10.29. *If in an infinitesimal cohesive neighbourhood $i : \mathbf{H} \hookrightarrow \mathbf{H}_{\text{th}}$ both \mathbf{H} as well as \mathbf{H}_{th} have an ∞ -cohesive site of definition, then the morphism $E \rightarrow X$ in \mathbf{H} out of the total space of a locally constant ∞ -stack over X , 3.8.6, is formally étale.*

Proof. First observe that every discrete morphism $\text{Disc}(A \xrightarrow{f} B)$ is formally étale: since every discrete ∞ -groupoid is an ∞ -colimit over the ∞ -functor constant on the point, $\phi_* : i_!^* \rightarrow i_*^*$ is an equivalence, and $i_! \rightarrow i_*$ preserves ∞ -colimits, so we have that $\phi_{\text{Disc}(A)}$ and $\phi_{\text{Disc}(B)}$ are equivalences. Therefore the relevant diagram is an ∞ -pullback.

Next, by definition, $E \rightarrow X$ is a pullback of a discrete morphism. By prop. 3.10.28 this pullback is preserved by $i_!$ and so by prop. 3.10.25 also $E \rightarrow X$ is locally étale. □

Remark 3.10.30. The properties listed in prop. 3.10.24 imply in particular that étale morphisms in \mathbf{H}_{th} are “admissible maps” modelling a notion of *local homeomorphism* in a *geometry for structured ∞ -toposes* according to def. 1.2.1 of [L-Geo]. In the terminology used there this means that \mathbf{H}_{th} equipped with its canonical topology and with this notion of admissible maps is a *geometry*, see remark 3.10.43 below.

Another proposal for an axiomatization of *open maps* and étale maps has been proposed in [JoyMo94], and the above list of properties covers most, but not necessarily all of these axioms.

In order to interpret the notion of formal smoothness, we close by further discussion of infinitesimal reduction.

Observation 3.10.31. The operation **Red** is an idempotent projection of \mathbf{H}_{th} onto the image of \mathbf{H} under $i_!$:

$$\mathbf{Red} \mathbf{Red} \simeq \mathbf{Red}.$$

Accordingly also

$$\mathbf{\Pi}_{\text{inf}} \mathbf{\Pi}_{\text{inf}} \simeq \mathbf{\Pi}_{\text{inf}}$$

and

$$\flat_{\text{inf}} \flat_{\text{inf}} \simeq \flat_{\text{inf}}.$$

Proof. By definition of infinitesimal neighbourhood we have that $i_!$ is a full and faithful ∞ -functor. It follows that $i^*i_! \simeq \text{id}$ and hence

$$\begin{aligned} \mathbf{RedRed} &\simeq i_!i^*i_!i^* \\ &\simeq i_!i^* \quad . \\ &\simeq \mathbf{Red} \end{aligned}$$

□

Observation 3.10.32. For every $X \in \mathbf{H}_{\text{th}}$, we have that $\mathbf{\Pi}_{\text{inf}}(X)$ is formally smooth according to def. 3.10.11.

Proof. By prop. 3.10.31 we have that

$$\mathbf{\Pi}_{\text{inf}}(X) \rightarrow \mathbf{\Pi}_{\text{inf}}\mathbf{\Pi}_{\text{inf}}(X)$$

is an equivalence. As such it is in particular an effective epimorphism. □

3.10.5 Formally étale groupoids

We discuss an intrinsic realization of the notion of *formally étale groupoids* internal to a differential ∞ -topos. In typical models, for instance that discussed below in 4.5, formal étaleness automatically implies global étaleness, and so the following formulation captures the notion of *étale groupoid* objects in a differential ∞ -topos. For a classical texts on étale 1-groupoids see [MoMr03].

Recall from 3.6.7 that groupoid objects \mathcal{G} in an ∞ -topos \mathbf{H} are equivalent to effective epimorphisms $U \xrightarrow{p} X$ in \mathbf{H} , which we think of as being an *atlas* for $X \in \mathbf{H}$.

Definition 3.10.33. For $\mathbf{H} \xrightarrow{i} \mathbf{H}_{\text{th}}$ a differential ∞ -topos, def. 3.5.1, we say that a groupoid object is *formally étale* if the corresponding atlas $U \xrightarrow{p} X$ is a formally étale morphism, def. 3.10.16.

Remark 3.10.34. When \mathbf{H} is presented by a category of simplicial (pre)sheaves, 2.2.3, then for any simplicial presheaf X there is, by remark 2.3.29, a canonical atlas, given by the inclusion $\text{const}X_0 \rightarrow X$. If the presentation of X and the induced canonical atlas is understood explicitly, we often speak just of X itself being a formally étale groupoid or a *formally étale ∞ -stack*.

Observation 3.10.35. If $U \xrightarrow{p} X$ is a formally étale groupoid, then both $i_*U \xrightarrow{i_*p} i_*X$ and $i_!U \xrightarrow{i_!p} i_!X$ are effective epimorphisms in \mathbf{H}_{th} .

Proof. Since i_* is both left and right ∞ -adjoint, it preserves all the ∞ -limits and ∞ -colimits that define effective epimorphisms. Then since these are stable under ∞ -pullback, and since $p : U \rightarrow X$ being formally étale by definition means that $i_!p$ is an ∞ -pullback of i_* , it follows that also $i_!p$ is an effective epimorphism. □

3.10.6 Manifolds (separated)

We discuss a formalization of the notion of *separated manifold* (Hausdorff manifold) in a context of differential cohesion.

Let $\mathbb{A}^1 \in \mathbf{H}$ be a line object exhibiting the cohesion of \mathbf{H} according to def. 3.9.2.

Definition 3.10.36. An (unseparated) manifold $X \in \mathbf{H}_{\text{th}}$, def. 3.9.9, is *separated* if it admits a defining cover $\phi : \coprod_j \mathbb{A}^n \rightarrow X$ such that the induced Čech nerve is a formally étale groupoid over $\coprod_j \mathbb{A}^n$, def. 3.10.33.

Remark 3.10.37. In the standard synthetic differential model for differential cohesion, $\mathbb{A}^n \simeq \mathbb{R}^n$ is the standard Cartesian space (by prop. 4.3.33) and formal étaleness makes the components of the face maps be local diffeomorphisms (prop. 4.5.53 below). These are in particular open maps, which ensures that the corresponding space X is a smooth Hausdorff manifold in the traditional sense. This is prop. 4.5.38 below.

3.10.7 Structure sheaves

For $X \in \mathbf{H}_{\text{th}}$ an object in a differential cohesive ∞ -topos, we formulate

- the ∞ -topos $\text{Sh}_{\mathbf{H}}(\mathcal{X})$ of ∞ -sheaves over X , or rather of *formally étale maps into X* ;
- the *structure sheaf* \mathcal{O}_X of X .

The resulting pair $(\text{Sh}_{\mathbf{H}}, \mathcal{O}_X)$ is essentially a \mathbf{H}_{th} -structured ∞ -topos in the sense of [L-Geo].

One way to motivate the following construction, is to notice that for $G \in \text{Grp}(\mathbf{H}_{\text{th}})$ a differential cohesive ∞ -group with de Rham coefficient object $\flat_{\text{dR}}\mathbf{B}G$ and for $X \in \mathbf{H}_{\text{th}}$, def. 3.9.12 any differential homotopy type, the product projection

$$X \times \flat_{\text{dR}}\mathbf{B}G \rightarrow X$$

regarded as an object of the slice ∞ -topos $(\mathbf{H}_{\text{th}})_{/X}$ *almost* qualifies as a “bundle of flat \mathfrak{g} -valued differential forms” over X : for $U \rightarrow X$ a cover (a 1-epimorphism) regarded in $(\mathbf{H}_{\text{th}})_{/X}$, a U -plot of this product projection is a U -plot of X together with a flat \mathfrak{g} -valued de Rham cocycle on X .

This is indeed what the sections of a corresponding bundle of differential forms over X are supposed to look like – but only *if* $U \rightarrow X$ is sufficiently “spread out” over X , hence sufficiently étale. Because, on the extreme, if X is the point (the terminal object), then there should be no non-trivial section of differential forms relative to U over X , but the above product projection instead reproduces all the sections of $\flat_{\text{dR}}\mathbf{B}G$.

In order to obtain the correct cotangent-like bundle from the product with the de Rham coefficient object, it needs to be *restricted* to plots out of sufficiently étale maps into X . In order to correctly test differential form data, “suitable” here should be “formally”, namely infinitesimally. Hence the restriction should be along the full inclusion

$$(\mathbf{H}_{\text{th}})_{/X}^{\text{fet}} \hookrightarrow (\mathbf{H}_{\text{th}})_{/X}$$

of the formally étale maps into X . Since on formally étale covers the sections should be those given by $\flat_{\text{dR}}\mathbf{B}G$, one finds that the corresponding *sheaf of flat forms* $\mathcal{O}_X(\flat_{\text{dR}}\mathbf{B}G)$ must be the *coreflection* of the given projection along this map.

Definition 3.10.38. For $X \in \mathbf{H}_{\text{th}}$ an object, write

$$(\mathbf{H}_{\text{th}})_{/X}^{\text{fet}} \hookrightarrow (\mathbf{H}_{\text{th}})_{/X}$$

for the full sub- ∞ -category of the slice over X , def. 3.6.1, on the formally étale morphisms into X , def. 3.10.19.

Proposition 3.10.39. *The inclusion of def. 3.10.38 is both reflective as well as coreflective: we have a left and a right adjoint*

$$(\mathbf{H}_{\text{th}})_{/X}^{\text{fet}} \begin{array}{c} \xleftarrow{\quad} \\ \xrightarrow{\quad} \\ \xleftarrow{\quad} \\ \xrightarrow{\quad} \\ \text{Et} \end{array} (\mathbf{H}_{\text{th}})_{/X} \cdot$$

Proof. The reflection is given by the factorization of prop. 3.10.23. This exhibits $(\mathbf{H}_{\text{th}})_{/X}^{\text{fet}}$ as a presentable ∞ -category and hence, by the adjoint ∞ -functor theorem, the coreflection exists precisely if the inclusion preserves all small ∞ -colimits. Since the inclusion is full, for this it is sufficient to show that an ∞ -colimit in $(\mathbf{H}_{\text{th}})_{/X}$ of a diagram A that factors through the inclusion,

$$A : I \rightarrow (\mathbf{H}_{\text{th}})_{/X}^{\text{fet}} \hookrightarrow (\mathbf{H}_{\text{th}})_{/X} ,$$

is again in the inclusion. Since moreover ∞ -colimits in a slice are preserved and detected by the dependent sum, prop. 3.6.2, we are, by def. 3.10.19, reduced to showing that for the above diagram the square

$$\begin{array}{ccc} \lim_{\rightarrow i \in I} A_i & \longrightarrow & \mathbf{\Pi}_{\text{inf}} \lim_{\rightarrow i \in I} A_i \\ \downarrow & & \downarrow \\ X & \longrightarrow & \mathbf{\Pi}_{\text{inf}}(X) \end{array}$$

is an ∞ -pullback square in \mathbf{H}_{th} . Since $\mathbf{\Pi}_{\text{inf}}$ is a left adjoint by def. 3.10.1, this square is equivalent to

$$\begin{array}{ccc} \lim_{\rightarrow i \in I} A_i & \longrightarrow & \lim_{\rightarrow i \in I} \mathbf{\Pi}_{\text{inf}} A_i \\ \downarrow & & \downarrow \\ X & \longrightarrow & \mathbf{\Pi}_{\text{inf}}(X) \end{array} .$$

Now that this square is an ∞ -pullback follows since ∞ -colimits are preserved by ∞ -pullback in the ∞ -topos \mathbf{H}_{th} , def. 2.2.2, and the fact that every component square

$$\begin{array}{ccc} A_i & \longrightarrow & \mathbf{\Pi}_{\text{inf}} A_i \\ \downarrow & & \downarrow \\ X & \longrightarrow & \mathbf{\Pi}_{\text{inf}}(X) \end{array}$$

is an ∞ -pullback by the assumption that the diagram factored through the inclusion of the étale morphisms into the slice. \square

Proposition 3.10.40. *For $X \in \mathbf{H}_{\text{th}}$, the ∞ -category $(\mathbf{H}_{\text{th}})_{/X}^{\text{fet}}$ of def. 3.10.38 is an ∞ -topos, and the defining inclusion into the slice $(\mathbf{H}_{\text{th}})_{/X}$ is a geometric embedding.*

Proof. By prop. 3.10.39 the ∞ -category $\text{Sh}_{\mathbf{H}}(X)$ is the sub-slice induced by a reflective factorization system. This is a stable factorization system (in that the left class of $\mathbf{\Pi}_{\text{inf}}$ -equivalences is stable under ∞ -pullback) and reflective factorization systems are stable precisely if the corresponding reflector preserves finite ∞ -limits. Hence the embedding is a geometric embedding of a sub- ∞ -topos. \square

Definition 3.10.41. For \mathbf{H}_{th} a differential cohesive ∞ -topos and $X \in \mathbf{H}_{\text{th}}$, we call the ∞ -topos

$$\text{Sh}_{\mathbf{H}}(X) := (\mathbf{H}_{\text{th}})_{/X}^{\text{fet}}$$

the *petit ∞ -topos* of $X \in \mathbf{H}_{\text{th}}$. An object of $\text{Sh}_{\mathbf{H}}(X)$ we also call an *∞ -sheaf over X* . The composite functor

$$\mathcal{O}_X : \mathbf{H}_{\text{th}} \xrightarrow{(-) \times X} (\mathbf{H}_{\text{th}})_{/X} \xrightarrow{\text{Et}} (\mathbf{H}_{\text{th}})_{/X} =: \text{Sh}_{\mathbf{H}}(X) ,$$

with Et the right adjoint of prop. 3.10.39, we call the *structure ∞ -sheaf* of X . For $A \in \mathbf{H}_{\text{th}}$ we say that

$$\mathcal{O}_X(A) \in \text{Sh}_{\mathbf{H}}(X)$$

is the *∞ -sheaf of A -valued functions on X* .

Proposition 3.10.42. *The functor \mathcal{O}_X is right adjoint to the forgetful functor*

$$\mathrm{Sh}_{\mathbf{H}}(X) := (\mathbf{H}_{\mathrm{th}})_{/X}^{\mathrm{fet}} \hookrightarrow (\mathbf{H}_{\mathrm{th}})_{/X} \xrightarrow{\Sigma_X} \mathbf{H}_{\mathrm{th}} .$$

In particular it preserves all small ∞ -limits.

Proof. By essential uniqueness of ∞ -adjoints, it is sufficient to observe that the the component maps are pairwise adjoint. For the first this is prop. 3.6.2, for the second it is prop. 3.10.39. \square

Remark 3.10.43. The triple $(\mathbf{H}_{\mathrm{th}}, \mathrm{can}, \mathrm{fet})$ of the differential cohesive ∞ -topos equipped with

1. its *canonical topology* (a collection $\{U_i \rightarrow X\}_i$ of morphisms in \mathbf{H}_{th} is covering precisely if $\coprod_i U_i \rightarrow X$ is a 1-epimorphism, def. 2.3.3);
2. its class of formally étale morphisms, def. 3.10.19.

is a (large) *geometry* in the sense of [L-Geo]. For $X \in \mathbf{H}_{\mathrm{th}}$, the pair $(\mathrm{Sh}_{\mathbf{H}}(X), \mathcal{O}_X)$ of def. 3.10.41 is a *structured ∞ -topos* with respect to this geometry in the sense of [L-Geo]. In fact, it is essentially the structured ∞ -topos associated to X in the geometry \mathbf{H}_{th} by def. 2.2.9 there.

We close this section by making explicit the special case of ∞ -sheaves of *flat de Rham coefficients* over X .

Definition 3.10.44. For $G \in \mathrm{Grp}(\mathbf{H}_{\mathrm{th}})$ a differential cohesive ∞ -group and for $X \in \mathbf{H}_{\mathrm{th}}$ any object, we say that the ∞ -sheaf of flat $\exp(\mathfrak{g})$ -valued differential forms over X is

$$\mathcal{O}_X(\mathfrak{b}_{\mathrm{dR}}\mathbf{B}G) \in (\mathbf{H}_{\mathrm{th}})_{/X}^{\mathrm{fet}} \hookrightarrow (\mathbf{H}_{\mathrm{th}})_{/X} ,$$

where \mathcal{O}_X is given by def. 3.10.41 and where $\mathfrak{b}_{\mathrm{dR}}\mathbf{B}G$ is given by def. 3.9.12.

Definition 3.10.45. The canonical point $0 : * \rightarrow \mathfrak{b}_{\mathrm{dR}}\mathbf{B}G$ induces a section

$$(\mathrm{id}_X, 0) : X \rightarrow X \times \mathfrak{b}_{\mathrm{dR}}\mathbf{B}G$$

of the projection map. The image of this section under the coreflection of prop. 3.10.39

$$\begin{array}{ccc} & \mathcal{O}_X(\mathfrak{b}_{\mathrm{dR}}\mathbf{B}G) & \\ 0 := \mathrm{Et}(\mathrm{id}, 0) \nearrow & \downarrow & \\ X & \xrightarrow{=} & X \end{array}$$

we call the θ -section of the ∞ -sheaf of flat differential forms.

3.10.8 Critical loci, variational calculus and BV-BRST complexes

We give a general abstract formulation of the notion of *critical locus* of a function, the local of its domain where its first derivative vanishes. Applied to functions that are regarded as *action functionals* and with a constraint that the differential is trivial on certain boundaries, this critical locus is known as the space of solutions of the *Euler-Lagrange equations* of the action functional. If the ambient cohesive ∞ -topos is ∞ -localic, then this critical locus is what is called a *derived critical locus*, whose complex of functions is known as the *BV-BRST complex* of the action functional

Let $G \in \mathrm{Grp}(\mathbf{H}_{\mathrm{th}})$ be a differential cohesive ∞ -group. Write

$$\theta_G : G \rightarrow \mathfrak{b}_{\mathrm{dR}}\mathbf{B}G$$

for its canonical differential form, def. 3.9.29.

Definition 3.10.46. For $X \in \mathbf{H}_{\text{th}}$ any differential cohesive homotopy type and for

$$S : X \longrightarrow G$$

any morphism, write

$$\mathbf{d}S := S^*\theta : X \xrightarrow{S} G \xrightarrow{\theta_G} \mathbf{b}_{\text{dR}}\mathbf{B}G$$

for its composite with the canonical differential form on G , def. 3.9.29. We call this the *de Rham derivative* of S .

By def. 3.10.44 this corresponds to a section

$$\begin{array}{ccc} & \mathcal{O}_X(\mathbf{b}_{\text{dR}}\mathbf{B}G) & \\ & \nearrow \mathbf{d}S & \downarrow \\ X & \xrightarrow{=} & X \end{array}$$

of the ∞ -sheaf of flat G -valued forms over X , which we denote by the same symbols.

Definition 3.10.47. The *critical locus* of $S : X \rightarrow G$ is the object

$$\sum_{x:X} (\mathbf{d}S(x) \simeq 0) \in \mathbf{H}_{\text{th}}$$

in the ∞ -pullback

$$\begin{array}{ccc} \sum_{x:X} (\mathbf{d}S(x) \simeq 0) & \longrightarrow & X \\ \downarrow & & \downarrow 0 \\ X & \xrightarrow{\mathbf{d}S} & \mathcal{O}_X(\mathbf{b}_{\text{dR}}\mathbf{B}G) \end{array}$$

in $\text{Sh}_{\mathbf{H}_{\text{th}}}(X)$, where the horizontal section is the de Rham differential of S from def. 3.10.46, and where the right vertical morphism is the 0-section of def. 3.10.45.

If X here is itself a space of functions, then for *variational calculus* one wants to constrain the differential of S to vary the data in X only away from the boundary. This is what the following construction achieves.

Definition 3.10.48. Let $\Sigma \in \mathbf{H}_{\text{th}}$ be a manifold, def. 3.10.36, with boundary $\partial\Sigma \hookrightarrow \Sigma$. Let $A \in \mathbf{H}_{\text{th}}$ be any object. Then the *variational domain*

$$[\Sigma, A]_{\partial\Sigma} \in \mathbf{H}_{\text{th}}$$

is the ∞ -pullback in

$$\begin{array}{ccc} [\Sigma, A]_{\partial\Sigma} & \longrightarrow & \mathbf{b}[\partial\Sigma, A] \\ \downarrow & & \downarrow \\ [\Sigma, A] & \longrightarrow & \mathbf{b}[\Sigma, A] \end{array} .$$

For

$$S : [\Sigma, A]_{\partial\Sigma} \rightarrow G$$

a map, we say that its critical locus, def. 3.10.47

$$\sum_{\phi:\Sigma \rightarrow A} (\mathbf{d}S(\phi) \simeq 0)$$

is the space of solutions to the *Euler-Lagrange equations* of S .

3.10.9 Formal groupoids

The infinitesimal analog of an exponentiated ∞ -Lie algebra, 3.9.4, is a formal cohesive ∞ -group.

Definition 3.10.49. An object $X \in \mathbf{H}_{\text{th}}$ is a *formal cohesive ∞ -groupoid* if $\mathbf{\Pi}_{\text{inf}}X \simeq *$.

An ∞ -group object $\mathfrak{g} \in \mathbf{H}_{\text{th}}$ that is infinitesimal we call a *formal ∞ -group*.

For $X \in \mathbf{H}$ any object, we say $\mathfrak{a} \in \mathbf{H}_{\text{th}}$ is an *formal cohesive ∞ -groupoid over X* if $\mathbf{\Pi}_{\text{inf}}(\mathfrak{a}) \simeq \mathbf{\Pi}_{\text{inf}}(X)$; equivalently: if there is a morphism

$$\mathfrak{a} \rightarrow \mathbf{\Pi}_{\text{inf}}(X)$$

equivalent to the infinitesimal path inclusion, def. 3.10.1, for \mathfrak{a} .

Proposition 3.10.50. *An infinitesimal cohesive ∞ -groupoid, def. 3.10.49 – $X \in \mathbf{H}_{\text{th}}$ with $\mathbf{\Pi}_{\text{inf}}(X) \simeq *$ – is both geometrically contractible and has as underlying discrete ∞ -groupoid the point:*

- $\mathbf{\Pi}X \simeq *$
- $\Gamma X \simeq *$.

Proof. The first statement is implied by the fact both $i_!$ as well as i_* are full and faithful, by definition of infinitesimal neighbourhood. This means that if $\mathbf{\Pi}_{\text{inf}}(X) \simeq *$ then already $i^*X = \mathbf{\Pi}_{\text{inf}}(X) \simeq *$. Since $\mathbf{\Pi}_{\mathbf{H}_{\text{th}}} \simeq \mathbf{\Pi}_{\mathbf{H}}\mathbf{\Pi}_{\text{inf}}$ and $\mathbf{\Pi}_{\mathbf{H}}$ preserves the terminal object by cohesiveness, this implies the first claim.

The second statement follows by

$$\begin{aligned} \Gamma X &\simeq \mathbf{H}_{\text{th}}(*, X) \\ &\simeq \mathbf{H}_{\text{th}}(\mathbf{Red}*, X) \\ &\simeq \mathbf{H}_{\text{th}}(*, \mathbf{\Pi}_{\text{inf}}(X)). \\ &\simeq \mathbf{H}_{\text{th}}(*, *) \\ &\simeq * \end{aligned}$$

□

Observation 3.10.51. For all $X \in \mathbf{H}$, we have that X and $\mathbf{\Pi}_{\text{inf}}(X)$ are formal cohesive ∞ -groupoids over X , X by the constant infinitesimal path inclusion and $\mathbf{\Pi}_{\text{inf}}(X)$ by the identity.

Proof. For X this is tautological, for $\mathbf{\Pi}(X)$ it follows from prop. 3.10.31 and the $(i^* \dashv i_*)$ -zig-zag-identity. □

Proposition 3.10.52. *The delooping $\mathbf{B}\mathfrak{g}$ of a formal ∞ -group \mathfrak{g} , def. 3.10.49, is a formal ∞ -groupoid over the point.*

Proof. Since both i^* and i_* are right adjoint, $\mathbf{\Pi}_{\text{inf}}$ commutes with delooping. Therefore

$$\begin{aligned} \mathbf{\Pi}_{\text{inf}}\mathbf{B}\mathfrak{g} &\simeq \mathbf{B}\mathbf{\Pi}_{\text{inf}}\mathfrak{g} \\ &\simeq \mathbf{B}* \\ &\simeq * \\ &\simeq \mathbf{\Pi}_{\text{inf}}* \end{aligned}$$

□

4 Models

In this section we construct specific cohesive ∞ -toposes, 3.4, and differential cohesive ∞ -toposes, 3.5, and discuss the realization of the general abstract structures of 3.9 in these models.

We start with a generic class of models

- 4.1 – parameterized cohesive homotopy types;

which construct a new cohesive ∞ -topos $T\mathbf{H}$ from a given one \mathbf{H} , the *Goodwillie-tangent ∞ -topos* of \mathbf{H} . Where a generic \mathbf{H} is a cohesive version of homotopy theory and *non-abelian* cohomology, its tangent ∞ -topos $T\mathbf{H}$ extends \mathbf{H} by its stabilization given by stable cohesive homotopy types (cohesive spectrum objects) and hence also accommodates the cohesive *stable homotopy theory* and stable (meaning: generalized Eilenberg-Steenrod-type) cohesive cohomology. This construction can be considered in particular for all of the specific models to follow.

Next we discuss the following specific kinds of geometric cohesion:

- 4.2 – discrete cohesion;
- 4.3 – Euclidean-topological cohesion;
- 4.4 – smooth cohesion;
- 4.5 – synthetic differential cohesion;
- 4.6 – super- and supergeometric cohesion.

These six cohesive ∞ -toposes fit into a diagram of geometric morphisms of the following form:

$$\begin{array}{ccccc}
 & & \text{cohesion} & & \text{differential cohesion} & & \text{base} \\
 & & & & & & \infty\text{-topos} \\
 & & & & & & \\
 \text{supergeometry} & & \text{SmoothSuper}\infty\text{Grpd} & \xrightarrow{\quad} & \text{SynthDiffSuper}\infty\text{Grpd} & \xrightarrow{\quad} & \text{Super}\infty\text{Grpd} \\
 & & \downarrow & & \downarrow & & \downarrow \\
 \text{differential geometry} & & \text{Smooth}\infty\text{Grpd} & \xrightarrow{\quad} & \text{SynthDiff}\infty\text{Grpd} & \xrightarrow{\quad} & \infty\text{Grpd}
 \end{array}$$

In the bottom right we have plain ∞ -groupoids, modelling *discrete* cohesion, 4.2. The bottom left is the cohesive ∞ -topos of *smooth ∞ -groupoids*, 4.4 and the middle entry on the bottom is the cohesive ∞ -topos *synthetic differential cohesion*, 4.5. The total bottom row exhibits the latter as a model for *differential cohesion* in the sense of 3.5. This we regard as the standard model for *higher differential geometry*. The top row shows the supergeometric refinement of this situation. See below in 4.6 for more discussion of the top row of this diagram.

4.1 Parameterized cohesive homotopy theory

We discuss here, given any cohesive ∞ -topos \mathbf{H} , new ∞ -toposes of objects parameterized over those of \mathbf{H} , which are cohesive over \mathbf{H} .

- 4.1.1 – Bundles of cohesive homotopy types
- 4.1.2 – Bundles of cohesive stable homotopy types

The first of these is just the arrow category $\mathbf{H}^{\Delta[1]}$ of \mathbf{H} . While simple in itself, this is conceptually noteworthy as the ∞ -topos whose intrinsic cohomology is *twisted nonabelian cohomology* in \mathbf{H} according to the discussion in 3.6.12, and because it serves an illustrative purpose: it is a simple but non-trivial model of cohesion that illuminates the central notions, such as cohesive homotopy types, by elementary combinatorial reasoning.

The second of these is the “fiberwise stabilization” of the first, the tangent ∞ -topos $T\mathbf{H}$ of *parameterized spectrum objects* in \mathbf{H} . This is the class of cohesive ∞ -toposes whose intrinsic differential cohomology accommodates the *stable* (hence: generalized Eilenberg-Steenrod-type) differential cohomology in \mathbf{H} in the sense of [HoSi05] and generally is the *twisted differential stable cohomology* developed in [BNV13].

There is in fact a whole tower of cohesive ∞ -toposes interpolating between these two examples

$$\mathbf{H}^{\Delta[1]} \longrightarrow \dots \longrightarrow J^n \mathbf{H} \longrightarrow \dots \longrightarrow T\mathbf{H} ,$$

$$\downarrow$$

$$\mathbf{H}$$

where $J^n \mathbf{H} \simeq \text{Exc}^n(\infty\text{Grpd}^{*/}, \mathbf{H})$ is the ∞ -category of n -excisive ∞ -endofunctors. (This goes back to the observation in section 35 of [Jo08b], it follows with theorem 1.8 in [Go03] and more explicitly with theorem 7.1.1.10, remark 7.1.1.11 in [L-Alg].¹⁵) In terms of intrinsic cohomology this chain interpolates stagewise between general non-abelian twisted differential cohomology in \mathbf{H} on the left and twisted stable (generalized Eilenberg-Steenrod-type) differential cohomology in \mathbf{H} on the right. Since the higher Chern-Weil theory discussed here may be regarded as approximating the former by the latter, one may think of the intermediate stages here as the home of a tower of intermediate higher Chern-Weil theory. But for the moment we do not explore this further.

4.1.1 Bundles of cohesive homotopy types

We discuss a class of examples of cohesive ∞ -toposes that are obtained from a given cohesive ∞ -topos \mathbf{H} by passing to the ∞ -topos \mathbf{H}^D of interval-shaped diagrams in it. The cohesive interpretation of an object in \mathbf{H}^D is as a bundle of \mathbf{H} -cohesive ∞ -groupoids all whose fibers are regarded as being geometrically contractible.

Proposition 4.1.1. *Let \mathbf{H} be a cohesive ∞ -topos. Let D be a small category with initial object \perp and terminal object \top .*

There is an adjoint triple of ∞ -functors

$$D \begin{array}{c} \xrightarrow{\perp} \\ \xleftarrow{p} \\ \xrightarrow{*} \\ \xrightarrow{\top} \end{array} *$$

obtained from the inclusion of the terminal and the initial object.

¹⁵Thanks to Charles Rezk for discussion of this point.

The ∞ -functor ∞ -category \mathbf{H}^D (D -shaped diagrams in \mathbf{H}) is a cohesive ∞ -topos, exhibited by the composite adjoint quadruple

$$(\Pi \dashv \text{Disc} \dashv \Gamma \dashv \text{coDisc}) : \mathbf{H}^D \begin{array}{c} \xrightarrow{\quad \top^* \quad} \\ \xleftarrow{\quad p^* \quad} \\ \xrightarrow{\quad \perp_* \quad} \\ \xleftarrow{\quad \perp_* \quad} \end{array} \mathbf{H} \begin{array}{c} \xrightarrow{\quad \Pi_{\mathbf{H}} \quad} \\ \xleftarrow{\quad \text{Disc}_{\mathbf{H}} \quad} \\ \xrightarrow{\quad \Gamma_{\mathbf{H}} \quad} \\ \xleftarrow{\quad \text{coDisc}_{\mathbf{H}} \quad} \end{array} \infty\text{Grpd} .$$

Proof. Each of the first three functors induces an adjoint triple $(p_! \dashv p^* \dashv p_*)$, etc., where p^* is given by precomposition, $p_!$ by left ∞ -Kan extension and p_* by right ∞ -Kan extension (use for instance [L-Topos], A.2.8). In particular therefore \top^* preserves finite products (together with all small ∞ -limits). The adjointness $(\perp \dashv p \dashv \top)$ implies that $p_! \simeq \top^*$ and $\perp_! \simeq p^*$. This yields the adjoint quadruple as indicated. Finally it is clear that $\top^* p^* \simeq \text{id}$, which means that p^* is full and faithful, and by adjointness so is \perp_* . \square
The following simple example not only illustrates the above proposition, but also serves as a useful toy example for the notion of cohesion itself.

Example 4.1.2. For \mathbf{H} any cohesive ∞ -topos, also its arrow category $\mathbf{H}^{\Delta[1]}$ is cohesive.

In particular, for $\mathbf{H} = \infty\text{Grpd}$ (see 4.2 for a discussion of ∞Grpd as a cohesive ∞ -topos), the arrow ∞ -category $\infty\text{Grpd}^{\Delta[1]}$ is cohesive. This is equivalently the ∞ -category of ∞ -presheaves on the interval $\Delta[1]$, which in turn is equivalent to the ∞ -category of ∞ -sheaves on the topological spaces called the *Sierpinski space*

$$\text{Sierp} = (\{0, 1\}, \text{Opens} = (\emptyset \hookrightarrow \{1\} \hookrightarrow \{0, 1\}))$$

(see for instance [Joh02], B.3.2.11):

$$\infty\text{Grpd}^{\Delta[1]} \simeq \text{PSh}_{\infty}(\Delta[1]) \simeq \text{Sh}_{\infty}(\text{Sierp}) .$$

We call this the *Sierpinski ∞ -topos*.

Notice that the Sierpinski space, as a topological space,

1. is contractible;
2. is locally contractible;
3. has a focal point (a point whose only open neighbourhood is the entire space).

The Sierpinski ∞ -topos is 0-localic, being the image of the Sierpinski space under the embedding of topological spaces into ∞ -toposes. Accordingly the cohesion of $\text{Sh}_{\infty}(\text{Sierp})$ may be traced back to these three properties, which imply, in this order, that $\text{Sh}_{\infty}(\text{Sierp})$ is, as an ∞ -topos,

1. ∞ -connected;
2. locally ∞ -connected;
3. local.

So the Sierpinski space is the “abstract cohesive blob” on which the cohesion of $\text{Sh}_{\infty}(\text{Sierp})$ is modeled: it is the abstract “point with an open neighbourhood”.

While the cohesion encoded by the Sierpinski ∞ -topos is very simple, it may be instructive to make the geometric interpretation fully explicit (the reader may want to compare the following with the more detailed discussions of the meaning of the functor Π on a cohesive ∞ -topos below in 3.8.1):

an object of $\text{Sh}_{\infty}(\text{Sierp})$ is a morphism $[P \rightarrow X]$ in ∞Grpd . The functor Π sends this to its domain

$$\Pi([P \rightarrow X]) \simeq X .$$

In particular

$$\Pi([P \rightarrow *]) \simeq * .$$

Therefore Π sees $[P \rightarrow *]$ as being cohesively/geometrically contractible and sees a bundle $[P \rightarrow X]$ as having cohesively/geometrically contractible fibers. At the same time, for $X \in \infty\text{Grpd}$, we have

$$\text{Disc}(X) \simeq [X \xrightarrow{\text{id}} X],$$

which says that the base of such a bundle is regarded by the cohesion of the Sierpinski ∞ -topos as being discrete. Accordingly, we may interpret $[P \rightarrow X]$ as describing a discrete ∞ -groupoid X to which are attached cohesively contractible blobs, being the fibers of the morphism $P \rightarrow X$.

Even though they are geometrically contractible, these fibers have inner structure: this is seen by Γ , which takes the underlying ∞ -groupoid to be the total space of the bundle

$$\Gamma([P \rightarrow X]) \simeq P.$$

Finally a codiscrete object is one of the form

$$\text{coDisc}(Q) \simeq [Q \rightarrow *],$$

which is entirely cohesively contractible, for any inner structure.

Observation 4.1.3. Let \mathbf{H} be a cohesive ∞ -topos and regard the Sierpinski ∞ -topos \mathbf{H}^I , def. 4.1.2, as a cohesive ∞ -topos over \mathbf{H} . Then

1. the full sub- ∞ -category of \mathbf{H}^I on those objects for which *pieces have points*, def. 3.4.8, is canonically identified with the ∞ -category of effective epimorphisms in \mathbf{H} , hence with the ∞ -category of groupoid objects in \mathbf{H} , def. 3.6.88;
2. the full sub- ∞ -category of \mathbf{H}^I on those objects which have *one point per piece*, def. 3.4.8, is canonically identified with \mathbf{H} itself.

4.1.2 Bundles of cohesive stable homotopy types

We discuss here how given a cohesive ∞ -topos \mathbf{H} , there is its *tangent ∞ -topos* $T\mathbf{H}$ which is itself cohesive over $T\infty\text{Grpd}$ and which is an extension of \mathbf{H} by the stabilization $\text{Stab}(\mathbf{H})$ of \mathbf{H} , hence by the ∞ -category of spectrum objects in \mathbf{H} [L-Alg]. We observe that this is the class of ∞ -toposes whose intrinsic cohomology is *twisted stable cohomology* and that the *stable* homotopy types inside $T\mathbf{H}$ all canonically sit in the system of homotopy fiber sequences characteristic of (stable) differential cohomology (an observation due to [BNV13]).

The following goes back to theorem 1.8 in [Go03], see section 7.1.1 and section 8.3 in [L-Alg]. We present it in the fashion of section 35 of [Jo08b].

Definition 4.1.4. Let seq be the diagram ∞ -category of the form

$$\text{seq} := \left\{ \begin{array}{c} \vdots \\ \downarrow \\ \cdots \longrightarrow x_{n-1} \longrightarrow * \xrightarrow{\text{id}} * \\ \downarrow \swarrow \searrow \downarrow \downarrow \\ * \longrightarrow x_n \longrightarrow * \\ \downarrow \swarrow \searrow \downarrow \downarrow \\ \text{id} \downarrow * \longrightarrow x_{n+1} \longrightarrow \cdots \\ \downarrow \\ \vdots \end{array} \right\},$$

where n ranges over \mathbb{Z} . For \mathcal{C} an ∞ -category, write

$$\mathcal{C}^{\text{seq}} := \text{Func}(\text{seq}, \mathcal{C})$$

for the ∞ -category of ∞ -functors from seq .

Remark 4.1.5. For \mathcal{C} an ∞ -category with finite ∞ -limits, an ∞ -functor $E_\bullet : \text{seq} \rightarrow \mathcal{C}$ is equivalently

1. a choice of object $B \in \mathcal{C}$ (the image of the zero-object of seq);
2. a collection $\{E_n \in \mathcal{C}_{/B}\}_{n \in \mathbb{Z}}$ of objects in the slice of \mathcal{C} over B , def. 3.6.1 (the images of the $x_n \in \text{seq}$);
3. for each $n \in \mathbb{Z}$ a choice of homotopy from the zero-map $0_n : E_n \rightarrow E_{n+1}$ to itself, which by the universal property of the ∞ -fiber product is equivalently a map

$$E_n \rightarrow \Omega_B E_{n+1}$$

into the loop space object, def. 3.6.111, of $E_{n+1} \in \mathcal{C}_{/B}$.

One might call such a collection of data a *spectrum object* over B , but better to call it a *pre-spectrum object* over B .

Definition 4.1.6. For \mathcal{C} an ∞ -category with finite ∞ -limits, an object $E_\bullet \in \mathcal{C}^{\text{seq}}$, def. 4.1.4, over $B \in \mathcal{C}$ for which the morphisms of remark 4.1.5 are equivalences

$$E_n \xrightarrow{\simeq} \Omega_B E_{n+1} \quad , \quad n \in \mathbb{Z}$$

we call an Ω -*spectrum object* over B or just *spectrum object* over B . We write

$$T\mathcal{C} \hookrightarrow \mathcal{C}^{\text{seq}}$$

for the full sub- ∞ -category of \mathcal{C}^{seq} , def. 4.1.4, on the Ω -spectrum objects and call this the *Goodwillie-tangent ∞ -category* of \mathcal{C} , or just *tangent ∞ -category*, for short.

The following observation is originally due to Georg Biedermann, see section 35 of [Jo08b].

Proposition 4.1.7. *For \mathbf{H} an ∞ -topos, the inclusion $T\mathbf{H} \hookrightarrow \mathbf{H}^{\text{seq}}$ is left exact reflective, hence it has a left adjoint ∞ -functor (“spectrification”) which preserves finite ∞ -limits*

$$T\mathbf{H} \begin{array}{c} \xleftarrow{\text{lex}} \\ \xrightarrow{\quad} \end{array} \mathbf{H}^{\text{seq}} \quad .$$

Proof. By a small object argument in the presentable ∞ -category \mathbf{H} , one finds that the left adjoint exists and is given by a sufficiently long transfinite composite of looping maps $\text{id} \rightarrow \Omega$. This transfinite composition is an example of a filtered ∞ -colimit and in an ∞ -topos these preserve finite ∞ -limits, for instance by example 7.1.1.8 in [L-Alg]. \square

It therefore follows that

Proposition 4.1.8. *For \mathbf{H} an ∞ -topos also its tangent ∞ -category $T\mathbf{H}$, def. 4.1.8, is an ∞ -topos, to be called its tangent ∞ -topos.*

Proof. By prop. 4.1.7 $T\mathbf{H}$ is a left exact reflective sub- ∞ -category of an ∞ -topos, and so by the very definition 2.2.1 is itself an ∞ -topos. \square

Proposition 4.1.9. *If \mathbf{H} is an ∞ -topos which is cohesive, def. 3.4.1, then its tangent ∞ -topos $T\mathbf{H}$, prop. 4.1.8, is cohesive over $T\infty\text{Grpd}$ and infinitesimally cohesive def. 3.5, over \mathbf{H} . Moreover, the cohesive structure maps fit into a diagram of the form*

$$\begin{array}{ccccc}
 & & \xrightarrow{\Pi^{\text{sp}}} & & \\
 & & \xleftarrow{\text{Disc}^{\text{sp}}} & & \\
 & \text{Stab}(\mathbf{H}) & \xrightarrow{\Gamma^{\text{sp}}} & \text{Spectra} & , \\
 & & \xleftarrow{\text{coDisc}^{\text{sp}}} & & \\
 & \downarrow & & \downarrow & \\
 \mathbf{H} & \xrightarrow{d} & T\mathbf{H} & \xrightarrow{T\Pi} & T\infty\text{Grpd} \\
 & \xleftarrow{\text{tot}} & & \xleftarrow{T\text{Disc}} & \\
 & & & \xleftarrow{T\Gamma} & \\
 & & & \xleftarrow{T\text{coDisc}} & \\
 & \downarrow & & \downarrow & \\
 & \text{base} & & \text{base} & \\
 & & \xrightarrow{\Pi} & & \\
 & & \xleftarrow{\text{Disc}} & & \\
 & \mathbf{H} & \xrightarrow{\Gamma} & \infty\text{Grpd} & \\
 & & \xleftarrow{\text{coDisc}} & &
 \end{array}$$

where

- $\text{Stab}(\mathbf{H})$ is the stabilization of \mathbf{H} , the stable ∞ -category of spectrum object in \mathbf{H} [L-Alg];
- $\text{Spectra} = \text{Stab}(\infty\text{Grpd})$ is the stable ∞ -category of spectra;
- base is the ∞ -functor that sends a bundle of spectra to its base homotopy type, exhibiting the infinitesimal cohesion of $T\mathbf{H}$ over \mathbf{H} ;
- its left and also right adjoint is the ∞ -functor that assigns the 0-bundle of spectra to a given base homotopy type;
- tot is the ∞ -functor which sends a bundle E_\bullet of spectra in a slice of \mathbf{H} to $\Omega^\infty E_\bullet = E_0$;
- d is its left adjoint

Proof. To see that $T\mathbf{H}$ is cohesive over \mathbf{H} observe that the prolongation of the right adjoints ($\text{Disc} \dashv \Gamma \dashv \text{coDisc}$) to presheaves over seq , as in the proof of prop. 4.1.8, immediately descent to $T\mathbf{H}$, since they preserve ∞ -limits and hence the loop space objects involved in the definition of spectrum objects. The prolongation of Π may fail to preserve these but by the lex reflection of spectrum objects inside pre-spectrum objects it follows that the composition of the prolongation of Π with spectrification is left adjoint to the prolongation of Disc and does preserve finite ∞ -limits and hence finite ∞ -products. This establishes the cohesion ($T\Pi \dashv T\text{Disc} \dashv T\Gamma \dashv T\text{coDisc}$).

That $T\mathbf{H}$ is infinitesimal cohesive over \mathbf{H} follows from the fact that spectrum objects contain a zero-object.

Finally the left adjoint d to tot is due to section 7.3 of [L-Alg]. □

Remark 4.1.10. In section 7.3 of [L-Alg] the left adjoint $d : \mathcal{C} \rightarrow \mathbf{TC}$ of the total space ∞ -functor is identified as the *co-tangent complex ∞ -functor* if the objects of the ∞ -category \mathcal{C} are interpreted as *algebras* of some kind. But in our case the objects of \mathbf{H} are instead to be interpreted as *spaces* of some kind, while it would be the objects of the opposite category $\mathcal{C} = \mathbf{H}^{\text{op}}$ that behave like generalized algebras. Therefore in the above d should instead be thought of as a *tangent complex ∞ -functor*.

To capture the fact that tangent cohesion involves stable homotopy theory, it is useful to introduce the following terminology (following Joyal)

Definition 4.1.11. Given an ∞ -topos \mathcal{E} , then an object $X \in \mathcal{E}$ is called a *stable homotopy type* or just *stable* if the canonical morphism

$$X \longrightarrow \Omega\Sigma X$$

into the loop space objects, def. 3.6.111, of its suspension object $\Sigma X := * \coprod_X *$ is an equivalence.

Example 4.1.12. In $\infty\text{Grpd} \simeq \text{Top}[\{\text{weak hom. equiv.}^{-1}\}]$ the only stable homotopy type is the point.

Example 4.1.13. In a tangent ∞ -topos $T\mathbf{H}$ all the objects in the inclusion $\text{Stab} \hookrightarrow T\mathbf{H}$ are stable homotopy types.

We now discuss the various general abstract structures induced by cohesion, 3.9, realized in Goodwillie-tangent cohesion.

- 4.1.2.1 – Cohomology
- 4.1.2.2 – Differential cohomology

4.1.2.1 Cohomology We discuss the notion of intrinsic cohomology, 3.6.9, realized in parameterized stable cohesive homotopy types.

The following proposition says that the intrinsic cohomology of tangent ∞ -toposes, as discussed generally in 3.6.9, is *twisted stable cohomology*, the stable version of the twisted cohomology discussed in 3.6.12.

Proposition 4.1.14. For $T\mathbf{H}$ a tangent ∞ -topos, prop. 4.1.8, and for

- $X \in \mathbf{H} \hookrightarrow T\mathbf{H}$ a homotopy type
- $E \in \text{Stab}(\mathbf{H}) \hookrightarrow T\mathbf{H}$ a stable homotopy type

then the internal hom

$$[X, E]_{T\mathbf{H}} \in T\mathbf{H}$$

is equivalent to the mapping spectrum

$$[X, E]_{T\mathbf{H}} \simeq [\Sigma^\infty X, E]_{\text{Stab}(\mathbf{H})} \in \text{Stab}(\mathbf{H}) \hookrightarrow T\mathbf{H}.$$

Proof. With $T\mathbf{H} \hookrightarrow \mathbf{H}^{\text{seq}}$ as in the proof of prop. 4.1.8, $X \in T\mathbf{H}$ is the constant seq-diagram on $X \in \mathbf{H}$, while E is a diagram with base point the terminal object. From this the statement follows from the general formula for internal homs of diagram ∞ -categories and the ∞ -Yoneda lemma. \square
More generally, one is interested in *local coefficients* of spectra, def. 3.6.222, as follows.

Example 4.1.15. Let $E \in \text{Stab}(\mathbf{H})$ be equipped with the structure of an E_∞ -ring [L-Alg], and write $\text{GL}_1(E) \in \text{Stab}(\mathbf{H})$ for the abelian ∞ -group (connective spectrum) of units of E [ABGHR08]. Then there is the universal associated bundle of stable homotopy types, as discussed in 3.6.11,

$$\left[\begin{array}{c} E // \text{GL}_1(E) \\ \downarrow \\ \mathbf{BGL}_1(E) \end{array} \right] \in \text{Stab}(\mathbf{H} / \mathbf{BGL}_1(E)) \hookrightarrow T\mathbf{H}.$$

This is the *universal E-line ∞ -bundle* [ABG10a].

Proposition 4.1.16. For $X \in \mathbf{H} \hookrightarrow T\mathbf{H}$ a cohesive homotopy type and for $E//\mathrm{GL}_1(E) \in T\mathbf{H}$ a universal E -line ∞ -bundle as in prop. 4.1.15, then the internal mapping space

$$[X, E//\mathrm{GL}_1(E)]_{T\mathbf{H}} \in T\mathbf{H}$$

is the bundle of spectra in \mathbf{H} whose base homotopy type is the space $[X, \mathbf{BGL}_1(E)]_{\mathbf{H}}$ of twists of E -cohomology on X (as discussed in 3.6.12) and whose total space is the collection of all twisted E -cohomology spectra $E^\bullet(X)$ of X where the fiber over a twist $\chi \in [X, \mathbf{BGL}_1(E)]$ is $E^\chi(X)$:

$$[X, E//\mathrm{GL}_1(E)]_{T\mathbf{H}} \simeq \left[\begin{array}{c} E^\bullet(X) \\ \downarrow \\ [X, \mathbf{BGL}_1(E)] \end{array} \right]$$

Proof. This follows with a variation of the argument in the proof of prop. 4.1.14. An elegant formal homotopy type-theoretic proof has been written out by Mike Shulman in [nLab:tangent cohesion]. \square

4.1.2.2 Differential Cohomology We discuss the realization of the general abstract notion of differential cohomology, def. 3.9.6, realized in tangent cohesive ∞ -toposes.

The following is the central formal observation of [BNV13], there considered in $\mathrm{Stab}(\mathbf{H})$ for $\mathbf{H} = \mathrm{Smooth}\infty\mathrm{Grpd}$ as in 4.4 below.

Proposition 4.1.17. For \mathbf{H} a cohesive ∞ -topos, stable homotopy type (def. 4.1.13)

$$E \in \mathrm{Stab}(\mathbf{H}) \hookrightarrow T\mathbf{H}$$

in $T\mathbf{H}$ sits in a diagram of the form

$$\begin{array}{ccccc} & \Pi_{\mathrm{dR}}\Omega E & \longrightarrow & \flat_{\mathrm{dR}}\Sigma E & \\ & \nearrow & & \searrow & \\ \flat\Pi_{\mathrm{dR}}\Omega E & & E & \xrightarrow{\theta_E} & \Pi\flat_{\mathrm{dR}}\Sigma E \\ & \searrow & \nearrow & & \\ & \flat E & \longrightarrow & \Pi E & \end{array} \quad ,$$

where

- Π and \flat are the cohesion modalities of $T\mathbf{H}$ and Π_{dR} and \flat_{dR} are the de Rham modalities of $T\mathbf{H}$ as defined in 3.9.3;
- the diagonals are the homotopy fiber sequences of the Maurer-Cartan form on E , 3.9.5, (using that E is a stable homotopy type by example 4.1.13);
- the two squares are ∞ -pullback squares;
- the bottom morphism is the points-to-pieces transform, def. 3.4.6.

Proof. The diagram exists as a homotopy-commutative diagram by the naturality of the Π -unit and the b -counit. To see that the right square, the Π -naturality square of the Maurer-Cartan form of E , is an ∞ -pullback, observe that it extends to a diagram of the form

$$\begin{array}{ccccc} bE & \longrightarrow & E & \xrightarrow{\theta_E} & b_{\mathrm{dR}}\Sigma E \\ \downarrow \simeq & & \downarrow & & \downarrow \\ \Pi(bE) & \longrightarrow & \Pi E & \xrightarrow{\Pi\theta_E} & \Pi(b_{\mathrm{dR}}\Sigma E) \end{array} \quad ,$$

where, by stability of $\mathrm{Stab}(\mathbf{H})$ and using that Π preserves ∞ -colimits, both rows are homotopy fiber sequences def. 3.6.138. But by cohesion the morphism $bE \rightarrow \Pi bE$ is an equivalence, and hence by the homotopy-fiber characterization of homotopy pullbacks exhibits the naturality square on the right as a homotopy pullback. The argument for the other square is dual this reasoning. \square

Remark 4.1.18. By the discussion of higher Galois theory in 3.8.6, we find that the right diagram in prop. 4.1.17 says equivalently that the Maurer-Cartan form, 3.9.5, exhibits every stable cohesive homotopy type as a locally constant ∞ -stack over its de Rham coefficient homotopy type.

Remark 4.1.19. Diagrams as in prop. 4.1.17 have been known to be characteristic of differential cohomology theories, see for instance prop. 4.57 in [Bun12], where this is referred to as “the differential cohomology diagram”. Prop. 4.1.17 shows that this diagram is naturally and generally induced for every stable cohesive homotopy type, just by the axioms of cohesion and stability.

The existence of this diagram for every stable homotopy type makes the concepts of “cohesive” (e.g. “smooth”, 4.4) and “differential” merge into a single concept for stable homotopy types: it says that every cohesive stable homotopy type E is the differential coefficients of some differential cohomology theory whose underlying Eilenberg-Steenrod type cohomology theory is represented by the spectrum $\Pi(E)$ and whose de Rham coefficients are $b_{\mathrm{dR}}\Sigma E$.

4.2 Geometrically discrete ∞ -groupoids

For completeness, and because it serves to put some concepts into a useful perspective, we record aspects of the case of *discrete* cohesion, hence of plain ∞ -groupoids explicitly regarded as *geometrically discrete* ∞ -groupoids.

Observation 4.2.1. The terminal ∞ -sheaf ∞ -topos ∞Grpd is trivially a cohesive ∞ -topos, where each of the defining four ∞ -functors $(\Pi \dashv \text{Disc} \dashv \Gamma \dashv \text{coDisc}) : \infty\text{Grpd} \rightarrow \infty\text{Grpd}$ is an equivalence of ∞ -categories.

Definition 4.2.2. In the context of cohesive ∞ -toposes we say that ∞Grpd defines *discrete cohesion* and refer to its objects as *discrete ∞ -groupoids*.

More generally, given any other cohesive ∞ -topos

$$(\Pi \dashv \text{Disc} \dashv \Gamma \dashv \text{coDisc}) : \mathbf{H} \rightarrow \infty\text{Grpd}$$

the inverse image Disc of the global section functor is a full and faithful ∞ -functor and hence embeds ∞Grpd as a full sub- ∞ -category of \mathbf{H} . We say $X \in \mathbf{H}$ is a *discrete ∞ -groupoid* if it is in the image of Disc .

This generalizes the traditional use of the terms *discrete space* and *discrete group*:

- a *discrete space* is equivalently a 0-truncated discrete ∞ -groupoid;
- a *discrete group* is equivalently a 0-truncated group object in discrete ∞ -groupoids.

We now discuss some of the general abstract structures in cohesive ∞ -toposes, 3.9, in the context of discrete cohesion.

- 4.2.1 – Geometric homotopy
- 4.2.2 – Groups
- 4.2.3 – Cohomology
- 4.2.4 – Principal bundles
- 4.2.5 – Twisted cohomology
- 4.2.6 – Representations and associated bundles

4.2.1 Geometric homotopy

We discuss geometric homotopy and path ∞ -groupoids, 3.8.1, in the context of discrete cohesion, 4.2. Using $\text{sSet}_{\text{Quillen}}$ as a presentation for ∞Grpd this is entirely trivial, but for the equivalent presentation by $\text{Top}_{\text{Quillen}}$ it becomes effectively a discussion of the classical Quillen equivalence $\text{Top}_{\text{Quillen}} \simeq \text{sSet}_{\text{Quillen}}$ from the point of view of cohesive ∞ -toposes. It may be useful to make this explicit.

By the homotopy hypothesis-theorem the ∞ -toposes Top and ∞Grpd are equivalent, hence indistinguishable by general abstract constructions in ∞ -topos theory. However, in practice it can be useful to distinguish them as two different presentations for an equivalence class of ∞ -toposes. For that purposes consider the following

Definition 4.2.3. Define the quasi-categories

$$\text{Top} := N(\text{Top}_{\text{Quillen}})^\circ$$

and

$$\infty\text{Grpd} := N(\text{sSet}_{\text{Quillen}})^\circ.$$

Here on the right we have the standard model structure on topological spaces, $\text{Top}_{\text{Quillen}}$, and the standard model structure on simplicial sets, $\text{sSet}_{\text{Quillen}}$, and $N((-)^\circ)$ denotes the homotopy coherent nerve of the simplicial category given by the full sSet -subcategory of these simplicial model categories on fibrant-cofibrant objects.

For

$$(|-| \dashv \text{Sing}) : \text{Top}_{\text{Quillen}} \begin{array}{c} \xleftarrow{|-|} \\ \xrightarrow{\text{Sing}} \end{array} \text{sSet}_{\text{Quillen}}$$

the standard Quillen equivalence given by the singular simplicial complex-functor and geometric realization, write

$$(\mathbb{L}|-| \dashv \mathbb{R}\text{Sing}) : \text{Top} \begin{array}{c} \xleftarrow{\mathbb{L}|-|} \\ \xrightarrow{\mathbb{R}\text{Sing}} \end{array} \infty\text{Grpd}$$

for the corresponding derived ∞ -functors (the image under the homotopy coherent nerve of the restriction of $|-|$ and Sing to fibrant-cofibrant objects followed by functorial fibrant-cofibrant replacement) that constitute a pair of adjoint ∞ -functors modeled as morphisms of quasi-categories.

Since this is an equivalence of ∞ -categories either functor serves as the left adjoint and right ∞ -adjoint and so we have

Observation 4.2.4. Top is exhibited as a cohesive ∞ -topos by

$$(\Pi \dashv \text{Disc} \dashv \Gamma \dashv \text{coDisc}) : \text{Top} \begin{array}{c} \xrightarrow{\mathbb{L}\text{Sing}} \\ \xleftarrow{\mathbb{R}|-|} \\ \xrightarrow{\mathbb{L}\text{Sing}} \\ \xleftarrow{\mathbb{R}|-|} \end{array} \infty\text{Grpd}$$

In particular a presentation of the intrinsic fundamental ∞ -groupoid is given by the familiar singular simplicial complex construction

$$\Pi(X) \simeq \mathbb{R}\text{Sing}X.$$

Notice that the topology that enters the explicit construction of the objects in Top here does *not* show up as cohesive structure. A topological space here is a model for a *discrete* ∞ -groupoid, the topology only serves to allow the construction of $\text{Sing}X$. For discussion of ∞ -groupoids equipped with genuine *topological cohesion* see 4.3.

4.2.2 Groups

Discrete ∞ -groups may be presented by simplicial groups. See 3.6.8.2.

4.2.3 Cohomology

We discuss the general notion of cohomology in cohesive ∞ -toposes, 3.6.9, in the context of discrete cohesion.

Cohomology in Top is the ordinary notion of (nonabelian) cohomology. The equivalence to ∞Grpd makes manifest in which way this is equivalently the *cohomology of groups* for connected, homotopy 1-types, the *cohomology of groupoids* for general 1-types and generally, of course, the cohomology of ∞ -groups.

4.2.3.1 Group cohomology

Proposition 4.2.5. *For G a (discrete) group, A a (discrete) abelian group, the group cohomology of G with coefficients in the trivial G -module A is*

$$H_{\text{grp}}^n(G, A) \simeq \pi_0 \text{Disc} \infty\text{Grpd}(\mathbf{B}G, \mathbf{B}^n A).$$

The case of group cohomology with coefficients in a non-trivial module is a special case of *twisted cohomology* in $\text{Disc} \infty\text{Grpd}$. This is discussed below in 4.2.5.

4.2.4 Principal bundles

We discuss the general notion of principal ∞ -bundles in cohesive ∞ -toposes, 3.6.10, in the context of discrete cohesion.

There is a traditional theory of *strictly* principal Kan simplicial bundles, i.e. simplicial bundles with G action for which the shear map is an *isomorphism* instead of more generally a weak equivalence. A classical reference for this is [May67]. A standard modern reference is section V of [GoJa99]. We now compare this classical theory of strictly principal simplicial bundles to the theory of weakly principal simplicial bundles from 3.6.10.4.

Definition 4.2.6. Let G be a simplicial group and X a Kan simplicial set. A *strictly G -principal bundle* over X is a morphism of simplicial sets $P \rightarrow X$ equipped with a G -action on P over X such that

1. the G action is degreewise free;
2. the canonical morphism $P/G \rightarrow X$ out of the ordinary (1-categorical) quotient is an isomorphism of simplicial sets.

A morphism of strictly G -principal bundles over X is a map $P \rightarrow P'$ respecting both the G -action as well as the projection to X .

Write $\text{sGBund}(X)$ for the category of strictly G -principal bundles.

In [GoJa99] this is definition V3.1, V3.2.

Lemma 4.2.7. *Every morphism in $\text{sGBund}(X)$ is an isomorphism.*

In [GoJa99] this is remark V3.3.

Observation 4.2.8. Every strictly G -principal bundle is evidently also a weakly G -principal bundle, def. 3.6.182. In fact the strictly principal G -bundles are precisely those weakly G -principal bundles for which the shear map is an isomorphism. This identification induces a full inclusion of categories

$$\text{sGBund}(X) \hookrightarrow \text{wGBund}(X).$$

Lemma 4.2.9. *Every morphism of weakly principal Kan simplicial bundles is a weak equivalence on the underlying Kan complexes.*

Proposition 4.2.10. *For G a simplicial group, the category sSet_G of G -actions on simplicial sets and G -equivariant morphisms carries the structure of a simplicial model category where the fibrations and weak equivalences are those of the underlying simplicial sets.*

This is theorem V2.3 in [GoJa99].

Corollary 4.2.11. *For G a simplicial group and X a Kan complex, the slice category sSet_G/X carries a simplicial model structure where the fibrations and weak equivalences are those of the underlying simplicial sets after forgetting the map to X .*

Lemma 4.2.12. *Let G be a simplicial group and $P \rightarrow X$ a weakly G -principal simplicial bundle. Then the loop space $\Omega_{(P \rightarrow X)} \text{Ex}^\infty N(\text{wGBund}(X))$ has the same homotopy type as the derived hom space $\mathbb{R}\text{Hom}_{\text{sSet}_G/X}(P, P)$.*

Proof. By theorem V2.3 of [GoJa99] and lemma 4.2.9 the free resolution P^f of P from corollary 3.6.200 is a cofibrant-fibrant resolution of P in the slice model structure of corollary 4.2.11. Therefore the derived hom space is presented by the simplicial set of morphisms $\text{Hom}_{\text{sSet}_G/X}(P^f \cdot \Delta^\bullet, P^f)$ and all these morphisms are equivalences. Therefore by prop. 2.3 in [DwKa84a] this simplicial set is equivalent to the loop space of the nerve of the subcategory of sSet_G/X on the weak equivalences connected to P^f . By lemma 4.2.9 this subcategory is equivalent (isomorphic even) to the connected component of $\text{wGBund}(X)$ on P . \square

Proposition 4.2.13. *Under the simplicial nerve, the inclusion of observation 4.2.8 yields a morphism*

$$NsGBund(X) \rightarrow NwGBund(X) \in sSet_{\text{Quillen}}$$

which is

- for all G and X an isomorphism on connected components;
- not in general a weak equivalence.

Proof. Let $P \rightarrow X$ be a weakly G -principal bundle. To see that it is connected in $wGBund(X)$ to some strictly G -principal bundle, first observe that by corollary 3.6.200 it is connected via a morphism $P^f \rightarrow P$ to the bundle

$$P^f := \text{Rec}(X \leftarrow P/hG \xrightarrow{f} \overline{WG}),$$

which has free G -action, but does not necessarily satisfy strict principality. Since, by theorem 3.6.194, the morphism $P/hG \rightarrow X$ is an acyclic fibration of simplicial sets it has a section $\sigma : X \rightarrow P/hG$ (every simplicial set is cofibrant in $sSet_{\text{Quillen}}$). The bundle

$$P^s := \text{Rec}(X \xleftarrow{\text{id}} X \xrightarrow{f \circ \sigma} \overline{WG})$$

is strictly G -principal, and with the morphism

$$(P^s \rightarrow P^f) := \text{Rec} \left(\begin{array}{ccc} & P/hG & \\ \sim \swarrow & \uparrow & \searrow f \\ X & & \overline{WG} \\ \swarrow \text{id} & \uparrow \sigma & \nearrow f \circ \sigma \\ & X & \end{array} \right)$$

we obtain (non-naturally, due to the choice of section) in total a morphism $P^s \rightarrow P^f \rightarrow P$ of weakly G -principal bundles from a strictly G -principal replacement P^s to P .

To see that the full embedding of strictly G -principal bundles is also injective on connected components, notice that by lemma 4.2.12 if a weakly G -principal bundle P with degreewise free G -action is connected by a zig-zag of morphisms to some other weakly G -principal bundle P' , then there is already a direct morphism $P \rightarrow P'$. Since all strictly G -principal bundles have free action by definition, this shows that two of them that are connected in $wGBund(X)$ are already connected in $sGBund(X)$.

To see that in general $NsGBund(X)$ nevertheless does not have the correct homotopy type, it is sufficient to notice that the category $sGBund(X)$ is always a groupoid, by lemma 4.2.7. Therefore $NsGBund(X)$ it is always a homotopy 1-type. But by theorem 3.6.198 the object $NwGBund(X)$ is not an n -type if G is not an $(n-1)$ -type. \square

Corollary 4.2.14. *For all Kan complexes X and simplicial groups G there is an isomorphism*

$$\pi_0 NsGBund \simeq H^1(X, G) := \pi_0 \infty \text{Grpd}(X, \mathbf{BG})$$

between the isomorphism classes of strictly G -principal bundles over X and the first nonabelian cohomology of X with coefficients in G .

But this isomorphism on cohomology does not in general lift to an equivalence on cocycle spaces.

Proof. By prop. 4.2.13 and remark 3.6.199. \square

Remark 4.2.15. The first statement of corollary 4.2.14 is the classical classification result for strictly principal simplicial bundles, for instance theorem V3.9 in [GoJa99].

4.2.5 Twisted cohomology

We discuss the notion of twisted cohomology, 3.6.12, in the context of discrete cohesion.

Specifically, we discuss here ∞ -group cohomology for discrete ∞ -groups with coefficients in a module according to 3.6.13.

For G a (discrete) group and A a (discrete) group equipped with a G -action, write $\mathbf{B}^n A // G$ for the n -groupoid which is given by the crossed complex, def. 1.2.89 of groups

$$\mathbf{B}^n A // G := [A \rightarrow 1 \rightarrow \cdots \rightarrow 1 \rightarrow G]$$

coming from the given G -action on A . There is a canonical morphism

$$\mathbf{B}^n A // G \rightarrow \mathbf{B}G.$$

Proposition 4.2.16. *We have a fiber sequence*

$$\mathbf{B}^n A \rightarrow \mathbf{B}^n A // G \rightarrow \mathbf{B}G$$

in $\text{Disc}\infty\text{Grpd}$.

In view of remark 3.6.206 this fiber sequence exhibits a $\mathbf{B}^n A$ -fiber bundle which is associated to the universal G -principal ∞ -bundle, 4.2.4.

In generalization of prop. 4.2.5 we have

Proposition 4.2.17. *The group cohomology of G with coefficients in the module A is naturally identified with the id-twisted cohomology of $\mathbf{B}G$, relative to $\mathbf{B}^n A // G$,*

$$H_{\text{grp}}^n(G, A) \simeq \pi_0 \text{Disc}\infty\text{Grpd}_{[\text{id}]}(\mathbf{B}G, \mathbf{B}^n A // G).$$

Remark 4.2.18. Equivalently this says that group cohomology with coefficients in nontrivial modules A describes the sections of the bundle $\mathbf{B}^n A // G$.

4.2.6 Representations and associated bundles

We discuss canonical representations of automorphism ∞ -groups in $\text{Disc}\infty\text{Grpd}$, following 3.6.13.

For all of the following, fix a regular uncountable cardinal κ .

Definition 4.2.19. Write $\text{Core}\infty\text{Grpd}_\kappa$ for the core (the maximal ∞ -groupoid inside) the full sub- ∞ -category of ∞Grpd on the κ -small ∞ -groupoids, [L-Topos] def. 5.4.1.3. We regard this canonically as an object

$$\text{Core}\infty\text{Grpd}_\kappa \in \infty\text{Grpd}.$$

Remark 4.2.20. We have

$$\text{Core}\infty\text{Grpd}_\kappa \simeq \coprod_i \mathbf{BAut}(F_i),$$

where the coproduct ranges over all κ -small homotopy types $[F_i]$ and where $\text{Aut}(F_i)$ is the automorphism ∞ -group of any representative F_i of $[F_i]$.

Lemma 4.2.21. For X a κ -small ∞ -groupoid, and $f : Y \rightarrow X$ a morphism in ∞Grpd , the following are equivalent

1. for all objects $x \in X$ the homotopy fiber $Y_x := Y \times_X \{x\}$ of f is κ -small;
2. Y is κ -small.

Proof. The implication 1. \Rightarrow 2. is stated for ∞ -categories, and assuming that f is presented by a Cartesian fibration of simplicial sets, as prop. 5.4.1.4 in [L-Topos]. But by prop. 2.4.2.4 there, every Cartesian fibration between Kan complexes is a right fibration; and by prop. 2.1.3.3 there over a Kan complex every right fibration is a Kan fibration. Finally, by the Quillen model structure every morphism of ∞ -groupoids is presented by a Kan fibration. Therefore the condition that f be presented by a Cartesian morphism is automatic in our case.

For the converse, assume that all homotopy fibers are κ -small. We may write X as the ∞ -colimit of the functor constant on the point, over itself ([L-Topos], corollary 4.4.4.9)

$$X \simeq \lim_{\rightarrow x \in X} \{x\}.$$

Since ∞Grpd is an ∞ -topos, its ∞ -colimits are preserved by ∞ -pullback. Therefore we have an ∞ -pullback diagram

$$\begin{array}{ccc} \lim_{\rightarrow x \in X} Y_x & \xrightarrow{\simeq} & Y \\ \downarrow f & & \downarrow f \\ \lim_{\rightarrow x \in X} \{x\} & \xrightarrow{\simeq} & X \end{array}.$$

that exhibits Y as the ∞ -colimit over X of the homotopy fibers of f . By corollary 5.4.1.5 in [L-Topos], the κ -small ∞ -groupoids are precisely the κ -compact objects of ∞Grpd . By corollary 5.3.4.15 there, κ -compact objects are closed under κ -small ∞ -colimits. Therefore the above ∞ -colimit exhibits Y as a κ -small ∞ -groupoid. \square

Definition 4.2.22. Write $\widehat{\text{Core}\infty\text{Grpd}_\kappa} \rightarrow \text{Core}\infty\text{Grpd}_\kappa$ for the ∞ -pullback

$$\begin{array}{ccc} \widehat{\text{Core}\infty\text{Grpd}_\kappa} & \longrightarrow & Z|_{\infty\text{Grpd}} \\ \downarrow & & \downarrow \\ \text{Core}\infty\text{Grpd} & \longrightarrow & \infty\text{Grpd} \end{array}$$

of the universal right fibration $Z|_{\infty\text{Grpd}} \rightarrow \infty\text{Grpd}$, as in [L-Topos] above prop. 3.3.2.5., along the canonical map that embeds κ -small ∞ -groupoids into all ∞ -groupoids.

Proposition 4.2.23. *The morphism $\widehat{\text{Core}\infty\text{Grpd}}_{\kappa} \rightarrow \text{Core}\infty\text{Grpd}_{\kappa}$ is the κ -compact object-classifier, section 6.1.6 of [L-Topos], in ∞Grpd .*

Proof. By prop. 3.3.2.5 in [L-Topos] the universal right fibration classifies right fibrations; and for $[X] : * \rightarrow \infty\text{Grpd}$ the name of an ∞ -groupoid X , the homotopy fiber

$$Z \times_{\infty\text{Grpd}} \{[X]\} \simeq X$$

is equivalent to X . As in the proof of lemma 4.2.21, every morphism between ∞ -groupoids is represented by a Cartesian fibration. Since moreover every morphism out of an ∞ -groupoid into ∞Grpd factors essentially uniquely through $\widehat{\text{Core}\infty\text{Grpd}}_{\kappa}$ it follows that $\widehat{\text{Core}\infty\text{Grpd}}_{\kappa} \rightarrow \text{Core}\infty\text{Grpd}_{\kappa}$ classifies morphisms of ∞ -groupoids with κ -small homotopy fibers. By lemma 4.2.21 and using again that κ -compact objects in ∞Grpd are κ -small ∞ -groupoids, these are precisely the relatively κ -compact morphisms from def. 6.1.6.4 of [L-Topos]. \square

Remark 4.2.24. By remark 4.2.20 we have that $\widehat{\text{Core}\infty\text{Grpd}}_{\kappa} \rightarrow \text{Core}\infty\text{Grpd}_{\kappa}$ decomposes as a coproduct of morphisms $\coprod_{[F_i]} \rho_i$ indexed by the κ -small homotopy types. According to prop. 4.2.23 the (essentially unique) homotopy fiber of ρ_i is equivalent to the κ -small ∞ -groupoid F_i itself. Therefore by def. 3.6.149 we may write

$$\rho_i : F_i // \text{Aut}(F_i) \rightarrow \mathbf{BAut}(F_i)$$

and identify this with the canonical representation of $\text{Aut}(F_i)$ on F_i , exhibited, by example 3.6.206, as the universal F_i -fiber bundle which is ρ_i -associated to the universal $\text{Aut}(F_i)$ -principal bundle.

In terms of this perspective we have the following classical result.

Corollary 4.2.25. *For X a connected ∞ -groupoid, every morphism $P \rightarrow X$ in ∞Grpd with κ -small small homotopy fibers F (over one and hence, up to equivalence, over each object $x \in X$) arises as the F -fiber bundle ρ -associated to an $\text{Aut}(F)$ -principal ∞ -bundle, 3.6.10, given by an ∞ -pullback of the form*

$$\begin{array}{ccc} P & \longrightarrow & F // \text{Aut}(F) \\ \downarrow & & \downarrow \\ X & \longrightarrow & \mathbf{BAut}(F) \end{array} .$$

More discussion of discrete principal and discrete associated ∞ -bundles is in 3.8.6 and 4.2.4.

4.3 Euclidean-topological ∞ -groupoids

We discuss here *Euclidean-topological cohesion*, modeled on Euclidean topological spaces and continuous maps between them. This subsumes the homotopy theory of simplicial topological spaces.

Definition 4.3.1. Let $\text{CartSp}_{\text{top}}$ be the site whose underlying category has as objects the Cartesian spaces \mathbb{R}^n , $n \in \mathbb{N}$ equipped with the standard Euclidean topology and as morphisms the continuous maps between them; and whose coverage is given by good open covers.

Proposition 4.3.2. *The site $\text{CartSp}_{\text{top}}$ is an ∞ -cohesive site (def 3.4.17).*

Proof. Clearly $\text{CartSp}_{\text{loc}}$ has finite products, given by $\mathbb{R}^k \times \mathbb{R}^l \simeq \mathbb{R}^{k+l}$, and clearly every object has a point $* = \mathbb{R}^0 \rightarrow \mathbb{R}^n$. In fact $\text{CartSp}_{\text{top}}(*, \mathbb{R}^n)$ is the underlying set of the Cartesian space \mathbb{R}^n .

Let $\{U_i \rightarrow U\}$ be a good open covering family in $\text{CartSp}_{\text{top}}$. By the very definition of *good cover* it follows that the Čech nerve $C(\coprod_i U_i \rightarrow U) \in [\text{CartSp}^{\text{op}}, \text{sSet}]$ is degreewise a coproduct of representables.

The condition $\lim_{\rightarrow} C(\coprod_i U_i) \xrightarrow{\sim} \lim_{\rightarrow} U = *$ follows from the nerve theorem [Bors48], which asserts that $\lim_{\rightarrow} C(\coprod_i U_i \rightarrow U) \simeq \text{Sing}U$, and using that, as a topological space, every Cartesian space is contractible.

The condition $\lim_{\leftarrow} C(\coprod_i U_i) \xrightarrow{\sim} \lim_{\leftarrow} U = \text{CartSp}_{\text{loc}}(*, U)$ is immediate. Explicitly, for $(x_{i_0} \in U_{i_0}, \dots, x_{i_n} \in U_{i_n})$ a sequence of points in the covering patches of U such that any two consecutive ones agree in U , then they all agree in U . So the morphism of simplicial sets in question has the right lifting property against all boundary inclusions $\partial\Delta[n] \rightarrow \Delta[n]$ and is therefore is a weak equivalence. \square

Definition 4.3.3. Define

$$\text{ETop}\infty\text{Grpd} := \text{Sh}_{\infty}(\text{CartSp}_{\text{top}})$$

to be the ∞ -category of ∞ -sheaves on $\text{CartSp}_{\text{top}}$.

Proposition 4.3.4. *The ∞ -category $\text{ETop}\infty\text{Grpd}$ is a cohesive ∞ -topos.*

Proof. This follows with prop. 4.3.2 by prop. 3.4.18. \square

Definition 4.3.5. We say that $\text{ETop}\infty\text{Grpd}$ defines *Euclidean-topological cohesion*. An object in $\text{ETop}\infty\text{Grpd}$ we call a *Euclidean-topological ∞ -groupoid*.

Definition 4.3.6. Write TopMfd for the category whose objects are topological manifolds that are

- finite-dimensional;
- paracompact;
- with an arbitrary set of connected components (hence not assumed to be second-countable);

and whose morphisms are continuous functions between these. Regard this as a (large) site with the standard open-cover coverage.

Proposition 4.3.7. *The ∞ -topos $\text{ETop}\infty\text{Grpd}$ is equivalently that of hypercomplete ∞ -sheaves ([L-Topos], section 6.5) on TopMfd*

$$\text{ETop}\infty\text{Grpd} \simeq \hat{\text{Sh}}_{\infty}(\text{TopMfd}).$$

Proof. Since every topological manifold admits an cover by open balls homeomorphic to a Cartesian space, we have that $\text{CartSp}_{\text{top}}$ is a dense sub-site of TopMfd . By theorem C.2.2.3 in [Joh02] it follows that the sheaf toposes agree

$$\text{Sh}(\text{CartSp}_{\text{top}}) \simeq \text{Sh}(\text{TopMfd}).$$

From this it follows directly that the Joyal model structures on simplicial sheaves over both sites (see [Jard87]) are Quillen equivalent. By [L-Topos], prop 6.5.2.14, these present the hypercompletions

$$\hat{\text{Sh}}_{\infty}(\text{CartSp}_{\text{top}}) \simeq \hat{\text{Sh}}_{\infty}(\text{TopMfd}).$$

of the corresponding ∞ -sheaf ∞ -toposes. But by corollary 3.4.3 we have that ∞ -sheaves on $\text{CartSp}_{\text{top}}$ are already hypercomplete, so that

$$\text{Sh}_{\infty}(\text{CartSp}_{\text{top}}) \simeq \hat{\text{Sh}}_{\infty}(\text{TopMfd}).$$

\square

Definition 4.3.8. Let Top_{cgH} be the 1-category of compactly generated and Hausdorff topological spaces and continuous functions between them.

Proposition 4.3.9. *The category Top_{cgH} is cartesian closed.*

See [Stee67]. We write $[-, -] : \text{Top}_{\text{cgH}}^{\text{op}} \times \text{Top}_{\text{cgH}} \rightarrow \text{Top}_{\text{cgH}}$ for the corresponding internal hom-functor.

Definition 4.3.10. There is an evident functor

$$j : \text{Top}_{\text{cgH}} \rightarrow \text{ETop}\infty\text{Grpd}$$

that sends each topological space X to the 0-truncated ∞ -sheaf (ordinary sheaf) represented by it

$$j(X) : (U \in \text{CartSp}_{\text{top}}) \mapsto \text{Hom}_{\text{Top}_{\text{cgH}}}(U, X) \in \text{Set} \hookrightarrow \infty\text{Grpd}.$$

Corollary 4.3.11. *The functor j exhibits TopMfd as a full sub- ∞ -category of $\text{ETop}\infty\text{Grpd}$*

$$j : \text{TopMfd} \hookrightarrow \text{ETop}\infty\text{Grpd}$$

Proof. By prop. 4.3.7 this is a special case of the ∞ -Yoneda lemma. □

Remark 4.3.12. While, according to prop. 4.3.7, the model categories $[\text{CartSp}_{\text{top}}^{\text{op}}, \text{sSet}]_{\text{proj}, \text{loc}}$ and $[\text{TopMfd}^{\text{op}}, \text{sSet}]_{\text{proj}, \text{loc}}$ are both presentations of $\text{ETop}\infty\text{Grpd}$, they lend themselves to different computations: in the former there are more fibrant objects, fewer cofibrant objects than in the latter, and vice versa.

In 3.4.2.2 we gave a general discussion concerning this point, here we amplify specific detail for the present case.

Proposition 4.3.13. *Let $X \in [\text{TopMfd}^{\text{op}}, \text{sSet}]$ be an object that is globally fibrant, separated and locally trivial, meaning that*

1. $X(U)$ is a non-empty Kan complex for all $U \in \text{TopMfd}$;
2. for every covering $\{U_i \rightarrow U\}$ in TopMfd the descent morphism $X(U) \rightarrow [\text{TopMfd}^{\text{op}}, \text{sSet}](C(\{U_i\}), X)$ is a full and faithful ∞ -functor;
3. for contractible U we have $\pi_0[\text{TopMfd}^{\text{op}}, \text{sSet}](C(\{U_i\}), X) \simeq *$.

Then the restriction of X along $\text{CartSp}_{\text{top}} \hookrightarrow \text{TopMfd}$ is a fibrant object in the local model structure $[\text{CartSp}_{\text{top}}^{\text{op}}, \text{sSet}]_{\text{proj}, \text{loc}}$.

Proof. The fibrant objects in the local model structure are precisely those that are Kan complexes over every object and for which the descent morphism is an equivalence for all covers. The first condition is given by the first assumption. The second and third assumptions imply the second condition over contractible manifolds, such as the Cartesian spaces. □

Example 4.3.14. Let G be a topological group, regarded as the presheaf over TopMfd that it represents. Write $\bar{W}G$ for the simplicial presheaf on TopMfd given by the nerve of the topological groupoid $(G \rightrightarrows *)$. (We discuss this in more detail in 4.3.2 below.)

The fibrant resolution of $\bar{W}G$ in $[\text{TopMfd}^{\text{op}}, \text{sSet}]_{\text{proj}, \text{loc}}$ is (the rectification of) its stackification: the stack $GBund$ of topological G -principal bundles. But the canonical morphism

$$\bar{W}G \rightarrow GBund$$

is a full and faithful functor (over each object $U \in \text{TopMfd}$): it includes the single object of $\bar{W}G$ as the trivial G -principal bundle. The automorphisms of the single object in $\bar{W}G$ over U are G -valued continuous functions on U , which are precisely the automorphisms of the trivial G -bundle. Therefore this inclusion is full and faithful, the presheaf $\bar{W}G$ is a separated prestack.

Moreover, it is locally trivial: every Čech cocycle for a G -bundle over a Cartesian space is equivalent to the trivial one. Equivalently, also $\pi_0 \text{GBund}(\mathbb{R}^n) \simeq *$. Therefore $\bar{W}G$, when restricted to $\text{CartSp}_{\text{top}}$, does become a fibrant object in $[\text{CartSp}_{\text{top}}^{\text{op}}, \text{sSet}]_{\text{proj,loc}}$.

On the other hand, let $X \in \text{TopMfd}$ be any non-contractible manifold. Since in the projective model structure on simplicial presheaves every representable is cofibrant, this is a cofibrant object in $[\text{Mfd}^{\text{op}}, \text{sSet}]_{\text{proj,loc}}$. However, it fails to be cofibrant in $[\text{CartSp}_{\text{top}}^{\text{op}}, \text{sSet}]_{\text{proj,loc}}$. Instead, there a cofibrant replacement is given by the Čech nerve $C(\{U_i\})$ of any good open cover $\{U_i \rightarrow X\}$.

This yields two different ways for computing the first nonabelian cohomology

$$H_{\text{ETop}}^1(X, G) := \pi_0 \text{ETop}\infty\text{Grpd}(X, \mathbf{B}G)$$

in $\text{ETop}\infty\text{Grpd}$ on X with coefficients in G :

1. $\dots \simeq \pi_0[\text{Mfd}^{\text{op}}, \text{sSet}](X, \text{GBund}) \simeq \pi_0 \text{GBund}(X)$;
2. $\dots \simeq \pi_0[\text{CartSp}_{\text{top}}^{\text{op}}, \text{sSet}](C(\{U_i\}), \bar{W}G) \simeq H^1(X, G)$.

In the first case we need to construct the fibrant replacement GBund . This amounts to constructing G -principal bundles over *all* paracompact manifolds and then evaluate on the given one, X , by the 2-Yoneda lemma. In the second case however we cofibrantly replace X by a good open cover, and then find the Čech cocycles with coefficients in G on that.

For ordinary G -bundles the difference between the two computations may be irrelevant in practice, because ordinary G -principal bundles are very well understood. However, for more general coefficient objects, for instance general topological simplicial groups G , the first approach requires to find the full ∞ -sheafification to the ∞ -sheaf of all principal ∞ -bundles, while the second approach requires only to compute specific cocycles over one specific base object. In practice the latter is often all that one needs.

We discuss a few standard techniques for constructing *cofibrant* resolutions in $[\text{CartSp}_{\text{top}}^{\text{op}}, \text{sSet}]_{\text{proj,loc}}$.

Proposition 4.3.15. *Let*

$$X \in \text{TopMfd} \hookrightarrow [\text{CartSp}_{\text{top}}^{\text{op}}, \text{sSet}]_{\text{proj,loc}}$$

be a topological manifold and let $\{U_i \rightarrow X\}$ be a good open cover. Then the Čech nerve

$$C(\{U_i\}) := \int^{[n] \in \Delta} \Delta[n] \cdot \prod_{i_0, \dots, i_n} j(U_{i_0}) \cap \dots \cap j(U_{i_n})$$

(where $j : \text{TopMfd} \hookrightarrow [\text{CartSp}_{\text{top}}^{\text{op}}, \text{sSet}]$ is the Yoneda embedding) equipped with the canonical projection $C(\{U_i\}) \rightarrow X$ is a cofibrant resolution of X .

Proof. The morphism is clearly a stalkwise weak equivalence. Therefore it is a weak equivalence in the local model structure by theorem, 2.2.12.

Moreover, by the very definition of *good* open cover the non-empty finite intersections of the U_i are themselves represented by objects in $\text{CartSp}^{\text{op}}$. Therefore the Čech nerve is degreewise a coproduct of representables. Also, its degeneracies split off as a direct summand in each degree. By [Dug01] this means that it is cofibrant in the global projective model structure. But the cofibrations do not change under left Bousfield localization to the local model structure, therefore it is cofibrant also there. \square

Proposition 4.3.16.

$$X_{\bullet} \in \text{TopMfd}^{\Delta^{\text{op}}} \hookrightarrow [\text{CartSp}_{\text{top}}^{\text{op}}, \text{sSet}]_{\text{proj}, \text{loc}}$$

be a simplicial manifold, such that there is a choice \mathcal{U} of good open covers $\{U_{n,i} \rightarrow X_n\}_i$ in each degree which are simplicially compatible in that they arrange into a morphism of bisimplicial presheaves

$$C(\mathcal{U})_{\bullet, \bullet} \rightarrow X_{\bullet, \bullet}$$

Then

$$\int^{[n] \in \Delta} \Delta[n] \cdot C(\mathcal{U})_{n, \bullet} \rightarrow X_{\bullet, \bullet}$$

where $\Delta : \Delta^{\text{op}} \rightarrow \text{sSet}$ is given by $\Delta[n] := N(\Delta/[n])$, is a cofibrant resolution in $[\text{CartSp}_{\text{top}}^{\text{op}}]_{\text{proj}, \text{loc}}$.

Proof. First consider

$$\int^{[n] \in \Delta} \Delta[n] \cdot C(\mathcal{U})_{n, \bullet} \rightarrow X_{\bullet}$$

with the ordinary simplex in the integrand. Over ach object $U \in \text{CartSp}_{\text{top}}$ the coend appearing here is isomorphic to the diagonal of the given bisimplicial set. Since the diagonal sends degreewise weak equivalences to weak equivalences, prop. 4.3.15 implies that this is a weak equivalence in the local model structure.

Let $\Delta \rightarrow \Delta$ be the canonical projection. We claim that the induced morphism

$$\int^{[n] \in \Delta} \Delta[n] \cdot C(\mathcal{U})_{n, \bullet} \rightarrow \int^{[n] \in \Delta} \Delta[n] \cdot C(\mathcal{U})_{n, \bullet}$$

is a global projective weak equivalence, and hence in particular also a local projective weak equivalence. This follows from the fact that

$$\int^{\Delta} (-) \cdot (-) : [\Delta, \text{sSet}_{\text{Quillen}}]_{\text{Reedy}} \times [\Delta^{\text{op}}, [\text{CartSp}^{\text{opop}}, \text{sSet}]_{\text{inj}}]_{\text{Reedy}} \rightarrow [\text{CartSp}^{\text{opop}}, \text{sSet}]_{\text{inj}}]_{\text{Reedy}}$$

is a left Quillen bifunctor prop. 2.3.17. Since every object in $[\Delta^{\text{op}}, [\text{CartSp}^{\text{opop}}, \text{sSet}]_{\text{inj}}]_{\text{Reedy}}$ is cofibrant, and since $\Delta \rightarrow \Delta$ is a Reedy equivalence between Reedy cofibrant objects, the coend over the tensoring preserves this weak equivalence and produces a global injective weak equivalence which is also a global projective weak equivalence.

This shows that the morphism in question is a weak equivalence. To see that it is a cofibrant resolution use that Δ is also cofibrant in $[\Delta, \text{sSet}]_{\text{proj}}$ and that also

$$\int^{\Delta} (-) \cdot (-) : [\Delta, \text{sSet}_{\text{Quillen}}]_{\text{proj}} \times [\Delta^{\text{op}}, [\text{CartSp}^{\text{opop}}, \text{sSet}]_{\text{proj}}]_{\text{inj}} \rightarrow [\text{CartSp}^{\text{opop}}, \text{sSet}]_{\text{proj}}$$

is a left Quillen bifunctor, prop. 2.3.17. By prop. 4.3.15 we have a cofibration $\emptyset \hookrightarrow C(\mathcal{U})_{\bullet, \bullet}$ in $[\Delta^{\text{op}}, [\text{CartSp}^{\text{opop}}, \text{sSet}]_{\text{proj}}]_{\text{inj}}$, which is therefore preserved by $\int^{\Delta} \Delta \cdot (-)$. Again using that global projective cofibrations are also local projective cofibrations, the claim follows. \square

We now discuss some of the general abstract structures in any cohesive ∞ -topos, 3.9, realized in $\text{ETop}\infty\text{Grpd}$.

- 4.3.1 – Stalks
- 4.3.2 – Groups
- 4.3.4 – Geometric homotopy
- 4.3.5 – \mathbb{R}^1 -homotopy / The standard continuum
- 4.3.6 – Manifolds
- 4.3.7 – Paths and geometric Postnikov towers
- 4.3.8 – Cohomology
- 4.3.9 – Principal ∞ -bundles
- 4.3.11 – Universal coverings and geometric Whitehead towers

4.3.1 Stalks

We discuss the points of $\text{ETop}\infty\text{Grpd}$.

Proposition 4.3.17. *For every $n \in \mathbb{N}$ there is a topos point*

$$p(n) : \text{Set} \begin{array}{c} \xleftarrow{p(n)^*} \\ \xrightarrow{p(n)_*} \end{array} \text{Sh}(\text{Mfd})$$

as well as a corresponding ∞ -topos point

$$p(n) : \infty\text{Grpd} \begin{array}{c} \xleftarrow{p(n)^*} \\ \xrightarrow{p(n)_*} \end{array} \text{ETop}\infty\text{Grpd} ,$$

where the inverse image $p(n)^*$ forms the stalk at the origin of \mathbb{R}^n :

$$p(n)^* : X \mapsto \varinjlim_{k \in \mathbb{N}} X(D^n(1/k)) .$$

Here for $r \in \mathbb{R}_{\geq 0}$ we denote by $D^n(r) \hookrightarrow \mathbb{R}^n$ the inclusion of the standard open n -disk of radius r . In particular

$$p(0) \simeq (\Gamma \dashv \text{coDisc}) .$$

The collection of topos points $\{p(n)\}_{n \in \mathbb{N}}$ exhibits the topos $\text{Sh}(\text{Mfd})$ and the ∞ -topos $\text{ETop}\infty\text{Grpd}$ (hence the sites CartSp and Mfd) as having enough points, def. 2.2.9.

These points form a tower of retractions

$$\begin{array}{ccccccc} p(0) & \begin{array}{c} \xleftarrow{\quad} \\ \xrightarrow{\quad} \end{array} & p(1) & \begin{array}{c} \xleftarrow{\quad} \\ \xrightarrow{\quad} \end{array} & \cdots & \begin{array}{c} \xleftarrow{\quad} \\ \xrightarrow{\quad} \end{array} & p(n) & \begin{array}{c} \xleftarrow{\quad} \\ \xrightarrow{\quad} \end{array} & \cdots . \\ & \searrow & & \searrow & & \searrow & & \searrow & \\ & & & & & & & & p(\infty) \end{array}$$

The inductive limit $p(\infty) := \varinjlim_n p(n)$ over the tower of inclusions is the topos point whose inverse image is given by

$$p(\infty)^* X = \varinjlim_n \varinjlim_k X(D^n(1/k)) .$$

This point alone forms a set of enough points: a morphism $f : X \rightarrow Y$ is an equivalence precisely if $p(\infty)^* f$ is.

Proof. For convenience, we discuss this in terms of the 1-topos. The discussion for the ∞ -topos is verbatim the same.

First it is clear that for all $n \in \mathbb{N}$ the functor $p(n)^*$ is indeed the inverse image of a geometric morphism: being given by a filtered colimit, it commutes with all colimits and with finite limits.

To see that these points are enough to detect isomorphisms of sheaves, notice the following construction. For $A \in \text{Sh}(\text{Mfd})$ and $X \in \text{Mfd}$, we obtain a sheaf $\tilde{A} \in \text{Sh}(\text{Mfd}/_{\text{op}}X)$ on the slice site of open embeddings into X by restriction of A . The topos $\text{Sh}(\text{Mfd}/_{\text{op}}X)$ clearly has enough points, given by the ordinary stalks at the ordinary points $x \in X$, formed as

$$p_x(n)^* \tilde{A} = \lim_{\rightarrow_k} \tilde{A}(D_x^n(1/k)),$$

where $D_x^n(r) \hookrightarrow \mathbb{R}^n \xrightarrow{\phi} X$ is a disk of radius r around x in any coordinate patch ϕ containing X . (Because if a morphism of sheaves on $\text{Mfd}/_{\text{op}}X$ is an isomorphism on an open disk around every point of X , then it is an isomorphism on the covering given by the union of all these disks, hence is an isomorphism of sheaves). Notice that by definition of \tilde{A} the above stalk is in fact independent of the point x and coincides with $p(n)^*$ applied to the original A :

$$\dots \simeq \lim_{\rightarrow_k} A(D^n(1/k)) =: p(n)^* A.$$

So if for a morphism $f : A \rightarrow B$ in $\text{Sh}(\text{Mfd})$ all the $p(n)^* f$ are isomorphisms, then for every $X \in \text{Mfd}$ the induced morphism $\tilde{f} : \tilde{A} \rightarrow \tilde{B}$ is an isomorphism, hence is an isomorphism $\tilde{f}(X) = f(X)$ on global sections. Since this is true for all X , it follows that f is already an isomorphism. This shows that $\{p(n)\}_{n \in \mathbb{N}}$ is a set of enough points of $\text{Sh}(\text{Mfd})$.

To see that these points sit in a sequence of retractions as stated, choose a tower of inclusions

$$\mathbb{R}^0 \hookrightarrow \mathbb{R}^1 \hookrightarrow \mathbb{R}^2 \hookrightarrow \dots \in \text{Mfd},$$

where each morphism is isomorphic to $\mathbb{R}^n \times \mathbb{R}^0 \xrightarrow{(\text{id}, 0)} \mathbb{R}^n \times \mathbb{R}^1$.

This induces for each $n \in \mathbb{N}$ and $r \in \mathbb{R}$ an inclusion of disks $D^n(r) \rightarrow D^{n+1}(r)$, which regards $D^n(r)$ as an equatorial plane of $D^{n+1}(r)$, and it induces a projection $D^{n+1}(r) \rightarrow D^n(r)$, which together exhibit a retraction

$$\begin{array}{ccccc} D^n & \longrightarrow & D^{n+1} & \longrightarrow & D^n \\ & & \text{id} & & \end{array} .$$

All this is natural with respect to the inclusions $D^n(\frac{1}{k+1}) \rightarrow D^n(\frac{1}{k})$. Therefore we have induced morphisms

$$\begin{array}{ccccc} \lim_{\rightarrow_k} X(D^n(1/k)) & \longrightarrow & \lim_{\rightarrow_k} X(D^{n+1}(1/k)) & \longrightarrow & \lim_{\rightarrow_k} X(D^n(1/k)) \\ & & \text{id} & & \end{array} .$$

Since these are natural in X , they constitute natural transformations

$$\begin{array}{ccccc} p(n)^* & \longrightarrow & p(n+1)^* & \longrightarrow & p(n)^* \\ & & \text{id} & & \end{array}$$

of inverse images, hence morphisms

$$\begin{array}{ccccc} p(n) & \longrightarrow & p(n+1) & \longrightarrow & p(n) \\ & & \text{id} & & \end{array}$$

of geometric morphisms.

Finally, since equivalences are stable under retract, it follows that $p(n)^*f$ is an equivalence if $p(n+1)^*$ is. Similarly, for every $n \in \mathbb{N}$ we have a retract

$$\begin{array}{ccccc} p(n) & \longrightarrow & p(\infty) & \longrightarrow & p(n) \\ & & \searrow & \nearrow & \\ & & \text{id} & & \end{array}$$

seen by noticing that each $p(n)$ naturally forms a co-cone under the above tower of inclusions. So an isomorphism under $p(\infty)^*$ implies one under all the $p(n)$. \square

4.3.2 Groups

We discuss cohesive ∞ -group objects, def 3.6.8, realized in $\mathbf{ETop}\infty\mathbf{Grpd}$: *Euclidean-topological ∞ -groups*.

Recall that by prop. 3.6.131 every ∞ -group object in $\mathbf{ETop}\infty\mathbf{Grpd}$ has a presentation by a presheaf of simplicial groups. Among the presentations for concrete ∞ -groups in $\mathbf{ETop}\infty\mathbf{Grpd}$ are therefore *simplicial topological groups*.

Write $\mathbf{sTop}_{\mathbf{cgH}}$ for the category of simplicial objects in $\mathbf{Top}_{\mathbf{cgH}}$, def. 4.3.8. For $X, Y \in \mathbf{sTop}_{\mathbf{cgH}}$, write

$$\mathbf{sTop}_{\mathbf{cgH}}(X, Y) := \int_{[k] \in \Delta} [X_k, Y_k] \in \mathbf{Top}_{\mathbf{cgH}}$$

for the hom-object, where in the integrand of the end $[-, -]$ is the internal hom of $\mathbf{Top}_{\mathbf{cgH}}$.

Definition 4.3.18. We say a morphism $f : X \rightarrow Y$ of simplicial topological spaces is a *global Kan fibration* if for all $n \in \mathbb{N}$ and $0 \leq k \leq n$ the canonical morphism

$$X_n \rightarrow Y_n \times_{\mathbf{sTop}_{\mathbf{cgH}}(\Lambda[n]_i, Y)} \mathbf{sTop}_{\mathbf{cgH}}(\Lambda[n]_i, X)$$

in $\mathbf{Top}_{\mathbf{cgH}}$ has a section, where $\Lambda[n]_i \in \mathbf{sSet} \hookrightarrow \mathbf{sTop}_{\mathbf{cgH}}$ is the i th n -horn regarded as a discrete simplicial topological space.

We say a simplicial topological space X_\bullet is a (*global*) *Kan simplicial space* if the unique morphism $X_\bullet \rightarrow *$ is a global Kan fibration, hence if for all $n \in \mathbb{N}$ and all $0 \leq i \leq n$ the canonical continuous function

$$X_n \rightarrow \mathbf{sTop}_{\mathbf{cgH}}(\Lambda[n]_i, X)$$

into the topological space of i th n -horns admits a section.

This global notion of topological Kan fibration is considered for instance in [BrSz89], def. 2.1, def. 6.1. In fact there a stronger condition is imposed: a Kan complex in \mathbf{Set} automatically has the lifting property not only against all full horn inclusions but also against sub-horns; and in [BrSz89] all these fillers are required to be given by global sections. This ensures that with X globally Kan also the internal hom $[Y, X] \in \mathbf{sTop}_{\mathbf{cgH}}$ is globally Kan, for any simplicial topological space Y . This is more than we need and want to impose here. For our purposes it is sufficient to observe that if f is globally Kan in the sense of [BrSz89], def. 6.1, then it is so also in the above sense.

For G a simplicial group, there is a standard presentation of its universal simplicial bundle by a morphism of Kan complexes traditionally denoted $WG \rightarrow \bar{W}G$. This construction has an immediate analog for simplicial topological groups. A review is in [RoSt12].

Proposition 4.3.19. *Let G be a simplicial topological group. Then*

1. G is a globally Kan simplicial topological space;
2. $\bar{W}G$ is a globally Kan simplicial topological space;

3. $WG \rightarrow \bar{W}G$ is a global Kan fibration.

Proof. The first and last statement appears as [BrSz89], theorem 3.8 and lemma 6.7, respectively, the second is noted in [RoSt12]. \square

Let for the following $\text{Top}_s \subset \text{Top}_{\text{cgh}}$ be any small full subcategory. Under the degreewise Yoneda embedding $\text{sTop}_s \hookrightarrow [\text{Top}_s^{\text{op}}, \text{sSet}]$ simplicial topological spaces embed into the category of simplicial presheaves on Top_s . We equip this with the projective model structure on simplicial presheaves $[\text{Top}_s^{\text{op}}, \text{sSet}]_{\text{proj}}$.

Proposition 4.3.20. *Under this embedding a global Kan fibration, def. 4.3.18, $f : X \rightarrow Y$ in sTop_s maps to a fibration in $[\text{Top}_s^{\text{op}}, \text{sSet}]_{\text{proj}}$.*

Proof. By definition, a morphism $f : X \rightarrow Y$ in $[\text{Top}_s^{\text{op}}, \text{sSet}]_{\text{proj}}$ is a fibration if for all $U \in \text{Top}_s$ and all $n \in \mathbb{N}$ and $0 \leq i \leq n$ diagrams of the form

$$\begin{array}{ccc} \Lambda[n]_i \cdot U & \longrightarrow & X \\ \downarrow & & \downarrow f \\ \Delta[n] \cdot U & \longrightarrow & Y \end{array}$$

have a lift. This is equivalent to saying that the function

$$\text{Hom}(\Delta[n] \cdot U, X) \rightarrow \text{Hom}(\Delta[n] \cdot U, Y) \times_{\text{Hom}(\Lambda[n]_i \cdot U, Y)} \text{Hom}(\Lambda[n]_i \cdot U, X)$$

is surjective. Notice that we have

$$\begin{aligned} \text{Hom}_{[\text{Top}_s^{\text{op}}, \text{sSet}]}(\Delta[n] \cdot U, X) &= \text{Hom}_{\text{sTop}_s}(\Delta[n] \cdot U, X) \\ &= \int_{[k] \in \Delta} \text{Hom}_{\text{Top}_s}(\Delta[n]_k \times U, X_k) \\ &= \int_{[k] \in \Delta} \text{Hom}_{\text{Top}_s}(U, [\Delta[n]_k, X_k]) \\ &= \text{Hom}_{\text{Top}}(U, \int_{[k] \in \Delta} [\Delta[n]_k, X_k]) \\ &= \text{Hom}_{\text{Top}_s}(U, \text{sTop}(\Delta[n], X)) \\ &= \text{Hom}_{\text{Top}_s}(U, X_n) \end{aligned}$$

and analogously for the other factors in the above morphism. Therefore the lifting problem equivalently says that the function

$$\text{Hom}_{\text{Top}}(U, X_n \rightarrow Y_n \times_{\text{sTop}_s(\Lambda[n]_i, Y)} \text{sTop}_s(\Lambda[n]_i, X))$$

is surjective. But by the assumption that $f : X \rightarrow Y$ is a global Kan fibration of simplicial topological spaces, def. 4.3.18, we have a section $\sigma : Y_n \times_{\text{sTop}_s(\Lambda[n]_i, Y)} \text{sTop}_s(\Lambda[n]_i, X) \rightarrow X_n$. Therefore $\text{Hom}_{\text{Top}_s}(U, \sigma)$ is a section of our function. \square

In section 4.3.4 we use this in the discussion of geometric realization of simplicial topological groups.

In summary, we find that $WG \rightarrow \bar{W}G$ is a presentation of the universal G -principal ∞ -bundle, 1.2.5.4).

Proposition 4.3.21. *Let $G \in \text{ETop}\infty\text{Grpd}$ be a group object presented in $[\text{CartSp}_{\text{top}}^{\text{op}}, \text{sSet}]_{\text{proj}, \text{loc}}$ by a simplicial topological group (to be denoted by the same symbol) which is degreewise a topological manifold. Then its delooping $\mathbf{B}G$, def. 3.6.113, is presented by $\bar{W}G$.*

Proof. By prop. 4.3.19 and prop. 4.3.20 the morphism $WG \rightarrow \bar{W}G$ is a fibration presentation of $* \rightarrow \mathbf{B}G$ in $[\text{CartSp}_{\text{top}}^{\text{op}}, \text{sSet}]_{\text{proj}}$. Since $\bar{W}G$ is evidently connected, and since we have an ordinary pullback diagram

$$\begin{array}{ccc} G & \longrightarrow & WG \\ \downarrow & & \downarrow \\ * & \longrightarrow & \bar{W}G \end{array},$$

it follows with the discussion in 2.3.2.1 that this presents in $\text{ETop}\infty\text{Grpd}$ the ∞ -pullback

$$\begin{array}{ccc} G & \longrightarrow & * \\ \downarrow & & \downarrow \\ * & \longrightarrow & \mathbf{B}G \end{array}$$

that defines the delooping $\mathbf{B}G$. □

4.3.3 Representations

We discuss the intrinsic notion of ∞ -group representations, 3.6.13, realized in the context $\text{ETop}\infty\text{Grpd}$.

We make precise the role of *topological action groupoids*, introduced informally in 1.2.5.1.

Proposition 4.3.22. *Let X be a topological manifold, and G a topological group. Then the category of continuous G -actions on X in the traditional sense is equivalent to the category of G -actions on X in the cohesive ∞ -topos $\text{ETop}\infty\text{Grpd}$, according to def. 3.6.149.*

Proof. For $\rho : X \times G \rightarrow X$ a given G -action, define the *action groupoid*

$$X//G := \left(X \times G \begin{array}{c} \xrightarrow{\rho} \\ \xrightarrow{p_1} \end{array} X \right)$$

with the evident composition operation. This comes with the evident morphism of topological groupoids

$$X//G \rightarrow *//G \simeq \mathbf{B}G,$$

with $\mathbf{B}G$ as in prop. 4.4.19. It is immediate that regarding this as a morphism in $[\text{CartSp}_{\text{top}}^{\text{op}}, \text{sSet}]_{\text{proj}}$ in the canonical way, this is a fibration. Therefore, by 2.3.13, the homotopy fiber of this morphism in $\text{Smooth}\infty\text{Grpds}$ is given by the ordinary fiber of this morphism in simplicial presheaves. This is manifestly X .

Accordingly this construction constitutes an embedding of the traditional G actions on X into the category $\text{Rep}_G(X)$ from def. 3.6.149. By turning this argument around, one finds that this embedding is essentially surjective. □

Remark 4.3.23. Let $X, \in \in \text{TopMfd}$, G a topological group, and let $\rho : X \times G \rightarrow X$ be a continuous action. Write $X//G \in \text{ETop}\infty\text{Grpd}$ for the corresponding action groupoid. As a simplicial topological space the action groupoid is

$$X//G = \left(\begin{array}{ccc} \cdots \cdots X \times G \times G & \begin{array}{c} \xrightarrow{(\rho, \text{id})} \\ \xrightarrow{(\text{id}, \cdot)} \\ \xrightarrow{(p_1, p_2)} \end{array} & X \times G \xrightarrow[p_1]{\rho} X \end{array} \right)$$

4.3.4 Geometric homotopy

We discuss the intrinsic geometric homotopy, 3.8.1, in $\text{ETop}\infty\text{Grpd}$.

4.3.4.1 Geometric realization of topological ∞ -groupoids We start by recalling some facts about geometric realization of simplicial topological spaces.

Definition 4.3.24. For $X_\bullet \in \text{sTop}_{\text{cgH}}$ a simplicial topological space, write

- $|X_\bullet| := \int^{[k] \in \Delta} \Delta_{\text{Top}}^k \times X_k$ for its *geometric realization*;
- $\|X_\bullet\| := \int^{[k] \in \Delta_+} \Delta_{\text{Top}}^k \times X_k$ for its *fat geometric realization*,

where in the second case the coend is over the subcategory $\Delta_+ \hookrightarrow \Delta$ spanned by the face maps.

See [RoSt12] for a review.

Proposition 4.3.25. *Ordinary geometric realization $| - | : \text{sTop}_{\text{cgH}} \rightarrow \text{Top}_{\text{cgH}}$ preserves pullbacks. Fat geometric realization preserves pullbacks when regarded as a functor $\| - \| : \text{sTop}_{\text{cgH}} \rightarrow \text{Top}_{\text{cgH}} / \| * \|$.*

Definition 4.3.26. We say

- a simplicial topological space $X \in \text{sTop}_{\text{cgH}}$, def. 4.3.8, is *good* if all degeneracy maps $s_i : X_n \rightarrow X_{n+1}$ are closed Hurewicz cofibrations;
- a simplicial topological group G is *well pointed* if all units $i_n : * \rightarrow G_n$ are closed Hurewicz cofibrations.

The notion of good simplicial topological spaces goes back to [Seg73]. For a review see [RoSt12].

Proposition 4.3.27. *For $X \in \text{sTop}_s$ a good simplicial topological space, its ordinary geometric realization is equivalent to its homotopy colimit, when regarded as a simplicial diagram:*

$$\text{sTop}_s \hookrightarrow [\text{Top}_s^{\text{op}}, \text{sSet}]_{\text{proj}} \xrightarrow{\text{hocolim}} \text{Top}_{\text{Quillen}} .$$

Proof. Write $\| - \|$ for the fat geometric realization. By standard facts about geometric realization of simplicial topological spaces [Seg70] we have the following zig-zag of weak homotopy equivalences

$$\begin{array}{ccc} \|X_\bullet\| & \xleftarrow{\simeq} & | \text{Sing}(X_\bullet) | \\ \downarrow \simeq & & \downarrow \simeq \\ |X_\bullet| & & | \text{Sing}(X_\bullet) | \xrightarrow[\text{iso}]{=} | \text{diagSing}(X_\bullet)_\bullet | \xrightarrow{\simeq} | \text{hocolim}_n \text{Sing} X_n | \end{array} .$$

By the Bousfield-Kan map, the object on the far right is manifestly a model for the homotopy colimit $\text{hocolim}_n X_n$. \square

Proposition 4.3.28. *For $X \in \text{TopMfd}$ and $\{U_i \rightarrow X\}$ a good open cover, the Čech nerve $C(\{U_i\}) := \int^{[k] \in \Delta} \Delta[k] \cdot \prod_{i_0, \dots, i_n} U_{i_0} \times_X \cdots \times U_{i_n}$ is cofibrant in $[\text{CartSp}_{\text{top}}^{\text{op}}, \text{sSet}]_{\text{proj,loc}}$ and the canonical projection $C(\{U_i\}) \rightarrow X$ is a weak equivalence.*

Proof. Since the open cover is good, the Čech nerve is degreewise a coproduct of representables, hence is a *split hypercover* in the sense of [DHS04], def. 4.13. Moreover $\prod_i U_i \rightarrow X$ is directly seen to be a *generalized cover* in the sense used there (below prop. 3.3) By corollary A.3 there, $C(\{U_i\}) \rightarrow X$ is a weak equivalence. \square

Proposition 4.3.29. *Let X be a paracompact topological space that admits a good open cover by open balls (for instance a topological manifold). Write $i(X) \in \mathbf{ETop}\infty\mathbf{Grpd}$ for its incarnation as a 0-truncated Euclidean-topological ∞ -groupoid. Then $\Pi(X) := \Pi(i(X)) \in \infty\mathbf{Grpd}$ is equivalent to the standard fundamental ∞ -groupoid of X , presented by the singular simplicial complex $\mathbf{Sing}X : [k] \mapsto \mathbf{Hom}_{\mathbf{Top}_{\mathbf{cGH}}}(\Delta^k, X)$*

$$\Pi(X) \simeq \mathbf{Sing}X.$$

Equivalently, under geometric realization $\mathbb{L}|-| : \infty\mathbf{Grpd} \rightarrow \mathbf{Top}$ we have that there is a weak homotopy equivalence

$$X \simeq |\Pi(X)|.$$

Proof. By the proof of prop. 3.4.18 we have an equivalence $\Pi(-) \simeq \mathbb{L}\varinjlim$ to the derived functor of the sSet-colimit functor $\varinjlim : [\mathbf{CartSp}^{\mathrm{op}}, \mathbf{sSet}]_{\mathrm{proj}, \mathrm{loc}} \rightarrow \mathbf{sSet}_{\mathrm{Quillen}}$.

To compute this derived functor, let $\{U_i \rightarrow X\}$ be a good open cover by open balls, hence homeomorphically by Cartesian spaces. By goodness of the cover the Čech nerve $C(\coprod_i U_i \rightarrow X) \in [\mathbf{CartSp}^{\mathrm{op}}, \mathbf{sSet}]$ is degreewise a coproduct of representables, hence a split hypercover. By [DHS04] we have that in this case the canonical morphism

$$C(\coprod_i U_i \rightarrow X) \rightarrow X$$

is a cofibrant resolution of X in $[\mathbf{CartSp}^{\mathrm{op}}, \mathbf{sSet}]_{\mathrm{proj}, \mathrm{loc}}$. Accordingly we have

$$\Pi(X) \simeq (\mathbb{L}\varinjlim)(X) \simeq \varinjlim C(\coprod_i U_i \rightarrow X).$$

Using the equivalence of categories $[\mathbf{CartSp}^{\mathrm{op}}, \mathbf{sSet}] \simeq [\Delta^{\mathrm{op}}, [\mathbf{CartSp}^{\mathrm{op}}, \mathbf{Set}]]$ and that colimits in presheaf categories are computed objectwise, and finally using that the colimit of a representable functor is the point (an incarnation of the Yoneda lemma) we have that $\Pi(X)$ is presented by the Kan complex that is obtained by contracting in the Čech nerve $C(\coprod_i U_i)$ each open subset to a point.

The classical nerve theorem [Bors48] asserts that this implies the claim. \square

Regarding \mathbf{Top} itself as a cohesive ∞ -topos by 4.2.1, the above proposition may be stated as saying that for X a paracompact topological space with a good covering, we have

$$\Pi_{\mathbf{ETop}\infty\mathbf{Grpd}}(X) \simeq \Pi_{\mathbf{Top}}(X).$$

Proposition 4.3.30. *Let X_\bullet be a good simplicial topological space that is degreewise paracompact and degreewise admits a good open cover, regarded naturally as an object $X_\bullet \in \mathbf{sTop}_{\mathbf{cGH}} \rightarrow \mathbf{ETop}\infty\mathbf{Grpd}$.*

We have that the intrinsic $\Pi(X_\bullet) \in \infty\mathbf{Grpd}$ coincides under geometric realization $\mathbb{L}|-| : \infty\mathbf{Grpd} \xrightarrow{\sim} \mathbf{Top}$ with the ordinary geometric realization of simplicial topological spaces $|X_\bullet|_{\mathbf{Top}\Delta^{\mathrm{op}}}$ from def. 4.3.25:

$$|\Pi(X_\bullet)| \simeq |X_\bullet|.$$

Proof. Write Q for Dugger's cofibrant replacement functor, prop. 2.2.18, on $[\mathbf{CartSp}^{\mathrm{op}}, \mathbf{sSet}]_{\mathrm{proj}, \mathrm{loc}}$. On a simplicially constant simplicial presheaf X it is given by

$$QX := \int^{[n] \in \Delta} \Delta[n] \cdot \left(\coprod_{U_0 \rightarrow \dots \rightarrow U_n \rightarrow X} U_0 \right),$$

where the coproduct in the integrand of the coend is over all sequences of morphisms from representables U_i to X as indicated. On a general simplicial presheaf X_\bullet it is given by

$$QX_\bullet := \int^{[k] \in \Delta} \Delta[k] \cdot QX_k,$$

which is the simplicial presheaf that over any $\mathbb{R}^n \in \text{CartSp}$ takes as value the diagonal of the bisimplicial set whose (n, r) -entry is $\coprod_{U_0 \rightarrow \dots \rightarrow U_n \rightarrow X_k} \text{CartSp}_{\text{top}}(\mathbb{R}^n, U_0)$. Since coends are special colimits, the colimit functor itself commutes with them and we find

$$\begin{aligned} \Pi(X_\bullet) &\simeq (\mathbb{L} \varinjlim) X_\bullet \\ &\simeq \varinjlim QX_\bullet \\ &\simeq \int^{[n] \in \Delta} \Delta[k] \cdot \varinjlim (QX_k). \end{aligned}$$

By general facts about the Reedy model structure on bisimplicial sets, this coend is a homotopy colimit over the simplicial diagram $\varinjlim QX_\bullet : \Delta \rightarrow \text{sSet}_{\text{Quillen}}$

$$\dots \simeq \text{hocolim}_\Delta \varinjlim QX_\bullet.$$

By prop. 4.3.29 we have for each $k \in \mathbb{N}$ weak equivalences $\varinjlim QX_k \simeq (\mathbb{L} \varinjlim) X_k \simeq \text{Sing} X_k$, so that

$$\begin{aligned} \dots &\simeq \text{hocolim}_\Delta \text{Sing} X_\bullet \\ &\simeq \int^{[k] \in \Delta} \Delta[k] \cdot \text{Sing} X_k \cdot \\ &\simeq \text{diag} \text{Sing}(X_\bullet). \end{aligned}$$

By prop. 4.3.27 this is the homotopy colimit of the simplicial topological space X_\bullet , given by its geometric realization if X_\bullet is proper. \square

4.3.4.2 Examples We discuss some examples related to the geometric realization of topological ∞ -groupoids.

Proposition 4.3.31. *Let K and G be topological groups whose underlying topological space is a manifold. Consider a morphism of topological groups $f : K \rightarrow G$ that is a homotopy equivalence of the underlying topological manifolds. Then*

$$\Pi \mathbf{B}f : \Pi(\mathbf{B}K) \longrightarrow \Pi(\mathbf{B}G)$$

is a weak equivalence.

Proof. By prop. 4.3.21 the delooping $\mathbf{B}G$ is presented in $[\text{CartSp}_{\text{top}^{\text{op}}}, \text{sSet}]_{\text{proj,loc}}$ by $(\mathbf{B}G_{\text{ch}}) : n \mapsto G^{\times n}$. Therefore $\Pi(K^{\times n}) \rightarrow \Pi(G^{\times n})$ is an equivalence in ∞Grpd . By the discussion in 3.6.8 we have that the delooping $\mathbf{B}K$ is the ∞ -colimit

$$\mathbf{B}K \simeq \lim_{\rightarrow n} K^{\times n}$$

and similarly for $\mathbf{B}G$. The morphism of moduli stacks is the ∞ -colimit of the component inclusions

$$\mathbf{c} \simeq \lim_{\rightarrow n} (K^{\times n} \rightarrow G^{\times n}).$$

Since Π is left adjoint, it commutes with these colimits, so that $\Pi(\mathbf{c})$ is exhibited as an ∞ -colimit over equivalences, hence as an equivalence. \square

Proposition 4.3.32. *Let X be a topological manifold, equipped with a continuous action $\rho : X \times G \rightarrow X$ of a group in TopMfd . Then the geometric realization of the corresponding action groupoid, def. 4.3.22, is the Borel space*

$$\Pi(X//G) \simeq |X//G| = X \times_G EG.$$

Proof. By remark 4.3.23 the action groupoid as an object in $\text{TopMfd}^{\Delta^{\text{op}}} \hookrightarrow [\text{CartSp}_{\text{Top}}, \text{sSet}]$ is

$$X//G = \left(\begin{array}{c} \cdots \cdots X \times G \times G \begin{array}{c} \xrightarrow{(\rho, \text{id})} \\ \xrightarrow{(\text{id}, \cdot)} \\ \xrightarrow{(p_1, p_2)} \end{array} X \times G \xrightarrow[p_1]{\rho} X \end{array} \right).$$

Accordingly

$$\mathbf{E}G := G//G = \left(\begin{array}{c} \cdots \cdots G \times G \times G \begin{array}{c} \xrightarrow{(\cdot, \text{id})} \\ \xrightarrow{(\text{id}, \cdot)} \\ \xrightarrow{(p_1, p_2)} \end{array} G \times G \xrightarrow[p_1]{\cdot} X \end{array} \right).$$

Therefore we have an isomorphism

$$X//G = X \times_G \mathbf{E}G.$$

By prop. 4.3.25 geometric realization preserves the product involved here, and, being given by a coend, it preserves the quotient involved, so that we have isomorphisms

$$|X//G| = |X \times_G \mathbf{E}G| = X \times_G EG.$$

□

Below in 4.3.8.3 we discuss how the cohomology of the Borel space is related to the equivariant cohomology of X .

4.3.5 \mathbb{R}^1 -homotopy / The standard continuum

We discuss that the standard continuum real line $\mathbb{R} \in \text{SmthMfd} \hookrightarrow \text{ETop}\infty\text{Grpd}$ regarded in Euclidean-topological cohesion is indeed a continuum \mathbb{A}^1 -line object in the general abstract sense of 3.8.1.

Proposition 4.3.33. *The real line $\mathbb{R}^1 \in \text{TopMfd} \hookrightarrow \text{ETop}\infty\text{Grpd}$ is a geometric interval, def. 3.9.2, exhibiting the cohesion of $\text{ETop}\infty\text{Grpd}$.*

Proof. Since $\text{CartSp}_{\text{top}}$ is a site of definition for $\text{ETop}\infty\text{Grpd}$ and is both ∞ -cohesive (prop. 4.3.2) and the syntactic category of a Lawvere algebraic theory, with

$$\mathbb{A}^1 = \mathbb{R}^1,$$

the claim follows with prop. 3.9.4. □

Remark 4.3.34. The statement of prop. 4.3.33 is the central claim of the notes [Dug99], where it essentially appears stated as theorem 3.4.3.

4.3.6 Manifolds

We discuss the realization of the general abstract notion of manifolds in a cohesive ∞ -topos in 3.9.2 realized in Euclidean-topological cohesion.

With $\mathbb{A} := \mathbb{R} \in \text{TopMfd} \hookrightarrow \text{ETop}\infty\text{Grpd}$ the standard line object exhibiting the cohesion of $\text{ETop}\infty\text{Grpd}$ according to prop. 4.3.33, def. 3.9.9 is equivalent to the traditional definition of topological manifolds.

4.3.7 Paths and geometric Postnikov towers

We discuss the general abstract notion of path ∞ -groupoid, 3.8.3, realized in $\mathbf{ETop}\infty\mathbf{Grpd}$.

Proposition 4.3.35. *Let X be a paracompact topological space, canonically regarded as an object of $\mathbf{ETop}\infty\mathbf{Grpd}$, then the path ∞ -groupoid $\mathbf{\Pi}(X)$ is presented by the simplicial presheaf $\mathbf{Disc\,Sing}X \in [\mathbf{CartSp}^{\mathrm{op}}, \mathbf{sSet}]$ which is constant on the singular simplicial complex of X :*

$$\mathbf{Disc\,Sing}X : (U, [k]) \mapsto \mathbf{Sing}X .$$

Proof. By definition we have $\mathbf{\Pi}(X) = \mathbf{Disc}\,\mathbf{\Pi}(X)$. By prop. 4.3.29 $\mathbf{\Pi}(X) \in \infty\mathbf{Grpd}$ is presented by $\mathbf{Sing}X$. By prop. 3.4.18 the ∞ -functor \mathbf{Disc} is presented by the left derived functor of the constant presheaf functor. Since every object in $\mathbf{sSet}_{\mathbf{Quillen}}$ is cofibrant this is just the plain constant presheaf functor. \square

A more natural presentation of the idea of a topological path ∞ -groupoid may be one that remembers the topology on the space of k -dimensional paths:

Definition 4.3.36. For X a paracompact topological space, write $\mathbf{Sing}X \in [\mathbf{CartSp}^{\mathrm{op}}, \mathbf{sSet}]$ for the simplicial presheaf given by

$$\mathbf{Sing}X : (U, [k]) \mapsto \mathbf{Hom}_{\mathbf{Top}}(U \times \Delta^k, X) .$$

Proposition 4.3.37. *Also $\mathbf{Sing}X$ is a presentation of $\mathbf{\Pi}X$.*

Proof. For each $U \in \mathbf{CartSp}$ the canonical inclusion of simplicial sets

$$\mathbf{Sing}X \rightarrow \mathbf{Sing}(X)(U)$$

is a weak homotopy equivalence, because U is continuously contractible. Therefore the canonical inclusion of simplicial presheaves

$$\mathbf{Disc\,Sing}X \rightarrow \mathbf{Sing}X$$

is a weak equivalence in $[\mathbf{CartSp}^{\mathrm{op}}, \mathbf{sSet}]_{\mathbf{proj}, \mathbf{loc}}$. \square

Remark 4.3.38. Typically one is interested in mapping out of $\mathbf{\Pi}(X)$. While $\mathbf{Disc\,Sing}X$ is always cofibrant in $[\mathbf{CartSp}^{\mathrm{op}}, \mathbf{sSet}]_{\mathbf{proj}}$, the relevant resolutions of $\mathbf{Sing}(X)$ may be harder to determine.

4.3.8 Cohomology

We discuss aspects of the intrinsic cohomology (3.6.9) in $\mathbf{ETop}\infty\mathbf{Grpd}$.

4.3.8.1 Čech cohomology We expand on the way that the intrinsic cohomology in $\mathbf{ETop}\infty\mathbf{Grpd}$ is expressed in terms of traditional Čech cohomology over manifolds, further specializing the general discussion of 2.2.5.

Proposition 4.3.39. *For $X \in \mathbf{TopMfd}$ and $A \in [\mathbf{CartSp}^{\mathrm{op}}, \mathbf{sSet}]_{\mathbf{proj}, \mathbf{loc}}$ a fibrant representative of an object in $\mathbf{ETop}\infty\mathbf{Grpd}$, the intrinsic cocycle ∞ -groupoid in $\mathbf{ETop}\infty\mathbf{Grpd}$ is given by the Čech cohomology cocycles on X with coefficients in A .*

Proof. Let $\{U_i \rightarrow X\}$ be a good open cover. By prop. 4.3.28 its Čech nerve $C(\{U_i\}) \xrightarrow{\cong} X$ is a cofibrant replacement for X (it is a split hypercover [Dug01] and hence cofibrant because the cover is good, and it is a weak equivalence because it is a *generalized cover* in the sense of [DHS04]). Since $[\mathbf{CartSp}^{\mathrm{op}}, \mathbf{sSet}]_{\mathbf{proj}, \mathbf{loc}}$ is a simplicial model category, it follows that the cocycle ∞ -groupoid in question is given by the Kan complex $[\mathbf{CartSp}^{\mathrm{op}}, \mathbf{sSet}](C(\{U_i\}), A)$. One checks that its vertices are Čech cocycles as claimed, its edges are Čech homotopies, and so on. \square

4.3.8.2 Nonabelian cohomology with constant coefficients

Definition 4.3.40. Let $A \in \infty\text{Grpd}$ be any discrete ∞ -groupoid. Write $|A| \in \text{Top}_{\text{egH}}$ for its geometric realization. For X any topological space, the nonabelian cohomology of X with coefficients in A is the set of homotopy classes of maps $X \rightarrow |A|$

$$H_{\text{Top}}(X, A) := \pi_0 \text{Top}(X, |A|).$$

We say $\text{Top}(X, |A|)$ itself is the cocycle ∞ -groupoid for A -valued nonabelian cohomology on X .

Similarly, for $X, \mathbf{A} \in \text{ETop}\infty\text{Grpd}$ two Euclidean-topological ∞ -groupoids, write

$$H_{\text{ETop}}(X, \mathbf{A}) := \pi_0 \text{ETop}\infty\text{Grpd}(X, \mathbf{A})$$

for the intrinsic cohomology of $\text{ETop}\infty\text{Grpd}$ on X with coefficients in \mathbf{A} .

Proposition 4.3.41. *Let $A \in \infty\text{Grpd}$, write $\text{Disc}A \in \text{ETop}\infty\text{Grpd}$ for the corresponding discrete topological ∞ -groupoid. Let X be a paracompact topological space admitting a good open cover, regarded as 0-truncated Euclidean-topological ∞ -groupoid.*

We have an isomorphism of cohomology sets

$$H_{\text{Top}}(X, A) \simeq H_{\text{ETop}}(X, \text{Disc}A)$$

and in fact an equivalence of cocycle ∞ -groupoids

$$\text{Top}(X, |A|) \simeq \text{ETop}\infty\text{Grpd}(X, \text{Disc}A).$$

Proof. By the $(\Pi \dashv \text{Disc})$ -adjunction of the locally ∞ -connected ∞ -topos $\text{ETop}\infty\text{Grpd}$ we have

$$\text{ETop}\infty\text{Grpd}(X, \text{Disc}A) \simeq \infty\text{Grpd}(\Pi(X), A) \xrightarrow[\simeq]{|-|} \text{Top}(|\Pi X|, |A|).$$

From this the claim follows by prop. 4.3.29. □

4.3.8.3 Equivariant cohomology

Proposition 4.3.42. *Given an action $\rho : X \times G \rightarrow X$ of a topological group G on a topological manifold X , as in prop. 4.3.32, $n \in \mathbb{N}$ and K a discrete group, abelian if $n \geq 2$, then the G -equivariant cohomology, def. 3.6.136, of X with coefficients in K is the cohomology of the Borel space, prop. 4.3.32, with values in K*

$$H_G^n(X, K) \simeq H^n(X \times_G EG, K).$$

Proof. The equivariant cohomology is the cohomology of the action groupoid

$$H_G^n(X, K) \simeq \pi_0 \text{ETop}\infty\text{Grpd}(X//G, \mathbf{B}^n K).$$

Since K is assumed discrete, this is equivalently, as in prop. 4.3.41,

$$\dots \simeq \pi_0 \infty\text{Grpd}(\Pi(X//G), \mathbf{B}^n K)$$

By prop. 4.3.32 this is

$$\dots \simeq \pi_0 \text{Top}(X \times_G EG, \mathbf{B}^n K) \simeq H^n(X \times_G EG, K).$$

□

4.3.9 Principal bundles

We discuss principal ∞ -bundles, 3.6.10, with topological structure and presented by topological simplicial principal bundles.

Proposition 4.3.43. *If G is a well-pointed simplicial topological group, def. 4.3.26, then both WG and $\bar{W}G$ are good simplicial topological spaces.*

Proof. For $\bar{W}G$ this is [RoSt12] prop. 19. For WG this follows with their lemma 10, lemma 11, which says that $WG = \text{Dec}_0 \bar{W}G$ and the observations in the proof of prop. 16 that $\text{Dec}_0 X$ is good if X is. \square

Proposition 4.3.44. *For G a well-pointed simplicial topological group, the geometric realization of the universal simplicial principal bundle $WG \rightarrow \bar{W}G$*

$$|WG| \rightarrow |\bar{W}G|$$

is a fibration resolution in $\text{Top}_{\text{Quillen}}$ of the point inclusion $ \rightarrow B|G|$ into the classifying space of the geometric realization of G .*

This is [RoSt12], prop. 14.

Proposition 4.3.45. *Let X_\bullet be a good simplicial topological space and G a well-pointed simplicial topological group. Then for every morphism*

$$\tau : X \rightarrow \bar{W}G$$

the corresponding topological simplicial principal bundle P over X is itself a good simplicial topological space.

Proof. The bundle is the pullback $P = X \times_{\bar{W}G} WG$ in sTop_{cgH}

$$\begin{array}{ccc} P & \longrightarrow & \bar{W}G \\ \downarrow & & \downarrow \\ X & \xrightarrow{\tau} & \bar{W}G \end{array}$$

By assumption on X and G and using prop. 4.3.43 we have that X , $\bar{W}G$ and WG are all good simplicial spaces. This means that the degeneracy maps of P_\bullet are induced degreewise by morphisms between pullbacks in Top_{cgH} that are degreewise closed cofibrations, where one of the morphisms in each pullback is a fibration. This implies that also these degeneracy maps of P_\bullet are closed cofibrations. \square

Proposition 4.3.46. *The homotopy colimit operation*

$$\text{sTop}_s \hookrightarrow [\text{Top}_s^{\text{op}}, \text{sSet}]_{\text{proj}} \xrightarrow{\text{hocolim}} \text{Top}_{\text{Quillen}}$$

preserves homotopy fibers of morphisms $\tau : X \rightarrow \bar{W}G$ with X good and G well-pointed (def. 4.3.26) and globally Kan (def. 4.3.18).

Proof. By prop. 4.3.19 and prop. 4.3.20 we have that $WG \rightarrow \bar{W}G$ is a fibration resolution of the point inclusion $* \rightarrow \bar{W}G$ in $[\text{Top}_s^{\text{op}}, \text{sSet}]_{\text{proj}}$. By general properties of homotopy limits this means that the homotopy fiber of a morphism $\tau : X \rightarrow \bar{W}G$ is computed as the ordinary pullback P in

$$\begin{array}{ccc} P & \longrightarrow & WG \\ \downarrow & & \downarrow \\ X & \xrightarrow{\tau} & \bar{W}G \end{array}$$

(since all objects X , $\bar{W}G$ and WG are fibrant and at least one of the two morphisms in the pullback diagram is a fibration) and hence

$$\mathrm{hofib}(\tau) \simeq P.$$

By prop. 4.3.19 and prop. 4.3.45 it follows that all objects here are good simplicial topological spaces. Therefore by prop. 4.3.27 we have

$$\mathrm{hocolim}P_{\bullet} \simeq |P_{\bullet}|$$

in $\mathrm{Ho}(\mathrm{Top}_{\mathrm{Quillen}})$. By prop. 4.3.25 we have that

$$\cdots = |X_{\bullet}| \times_{|\bar{W}G|} |WG|.$$

But prop. 4.3.44 says that this is again the presentation of a homotopy pullback/homotopy fiber by an ordinary pullback

$$\begin{array}{ccc} |P| & \longrightarrow & |WG| \\ \downarrow & & \downarrow \\ |X| & \xrightarrow{\tau} & |\bar{W}G| \end{array}$$

because $|WG| \rightarrow |\bar{W}G|$ is again a fibration resolution of the point inclusion. Therefore

$$\mathrm{hocolim}P_{\bullet} \simeq \mathrm{hofib}(|\tau|).$$

Finally by prop. 4.3.27 and using the assumption that X and $\bar{W}G$ are both good, this is

$$\cdots \simeq \mathrm{hofib}(\mathrm{hocolim}\tau).$$

In total we have shown

$$\mathrm{hocolim}(\mathrm{hofib}(\tau)) \simeq \mathrm{hofib}(\mathrm{hocolim}(\tau)).$$

□

We now generalize the model of *discrete* principal ∞ -bundles by simplicial principal bundles over simplicial groups, from 4.2.3, to Euclidean-topological cohesion.

Recall from theorem 3.8.19 that over any ∞ -cohesive site Π preserves homotopy pullbacks over discrete objects. The following proposition says that on $\mathrm{ETop}\infty\mathrm{Grpd}$ it preserves also a large class of ∞ -pullbacks over non-discrete objects.

Theorem 4.3.47. *Let G be a well-pointed simplicial group object in TopMfd . Then the ∞ -functor $\Pi : \mathrm{ETop}\infty\mathrm{Grpd} \rightarrow \infty\mathrm{Grpd}$ preserves homotopy fibers of all morphisms of the form $X \rightarrow \mathbf{B}G$ that are presented in $[\mathrm{CartSp}_{\mathrm{top}}^{\mathrm{op}}, \mathrm{sSet}]_{\mathrm{proj}}$ by morphism of the form $X \rightarrow \bar{W}G$ with X fibrant*

$$\Pi(\mathrm{hofib}(X \rightarrow \bar{W}G)) \simeq \mathrm{hofib}(\Pi(X \rightarrow \bar{W}G)).$$

Proof. By prop. 2.3.13 we may discuss the homotopy fiber in the global model structure on simplicial presheaves. Write $QX \xrightarrow{\cong} X$ for the global cofibrant resolution given by $QX : [n] \mapsto \coprod_{\{U_{i_0} \rightarrow \cdots \rightarrow U_{i_n} \rightarrow X_n\}} U_{i_0}$,

where the U_{i_k} range over $\mathrm{CartSp}_{\mathrm{top}}$ [Dug01]. This has degeneracies splitting off as direct summands, and hence is a good simplicial topological space that is degreewise in TopMfd . Consider then the pasting of two pullback diagrams of simplicial presheaves

$$\begin{array}{ccccc} P' & \xrightarrow{\cong} & P & \longrightarrow & WG \\ \downarrow & & \downarrow & & \downarrow \\ QX & \xrightarrow{\cong} & X & \longrightarrow & \bar{W}G \end{array}$$

Here the top left morphism is a global weak equivalence because $[\text{CartSp}_{\text{top}}^{\text{op}}, \text{sSet}]_{\text{proj}}$ is right proper. Since the square on the right is a pullback of fibrant objects with one morphism being a fibration, P is a presentation of the homotopy fiber of $X \rightarrow \bar{W}G$. Hence so is P' , which is moreover the pullback of a diagram of good simplicial spaces. By prop. 4.3.30 we have that on the outer diagram Π is presented by geometric realization of simplicial topological spaces $|-|$. By prop. 4.3.44 we have a pullback in $\text{Top}_{\text{Quillen}}$

$$\begin{array}{ccc} |P| & \longrightarrow & |WG| \\ \downarrow & & \downarrow \\ |QX| & \longrightarrow & |\bar{W}G| \end{array}$$

which exhibits $|P|$ as the homotopy fiber of $|QX| \rightarrow |\bar{W}G|$. But this is a model for $|\Pi(X \rightarrow \bar{W}G)|$. \square

4.3.10 Gerbes

We discuss ∞ -gerbes, 3.6.15, in the context of Euclidean-topological cohesion, with respect to the cohesive ∞ -topos $\mathbf{H} := \text{ETop}\infty\text{Grpd}$ from def. 4.3.3.

For $X \in \text{TopMfd}$ write

$$\mathcal{X} := \mathbf{H}/X$$

for the slice of \mathbf{H} over X , as in remark 3.6.137. This is equivalently the ∞ -category of ∞ -sheaves on X itself

$$\mathcal{X} \simeq \text{Sh}_{\infty}(X).$$

By remark 3.6.137 this comes with the canonical étale essential geometric morphism

$$(X! \dashv X^* \dashv X_*) : \mathbf{H}/X \begin{array}{c} \xrightarrow{X!} \\ \xleftarrow{X^*} \\ \xrightarrow{X_*} \end{array} \mathbf{H}.$$

Any topological group G is naturally an object $G \in \text{Grp}(\mathbf{H}) \subset \infty\text{Grp}(\mathbf{H})$ and hence as an object

$$X^*G \in \text{Grp}(\mathcal{X}).$$

Under the identification $\mathcal{X} \simeq \text{Sh}_{\infty}(X)$ this is the sheaf of groups which assigns sets of continuous functions from open subsets of X to G :

$$X^*G : (U \subset X) \mapsto C(U, G).$$

Since the inverse image X^* commutes with looping and delooping, we have

$$X^*\mathbf{B}G \simeq \mathbf{B}X^*G.$$

On the left $\mathbf{B}G$ is the abstract stack of topological G -principal bundles, regarded over X , on the right is the stack over X of X^*G -torsors.

More generally, an arbitrary group object $G \in \text{Grp}(\mathcal{X})$ is (up to equivalence) any sheaf of groups on X , and $\mathbf{B}G \in \mathcal{X}$ is the corresponding stack of G -torsors over X . (A detailed discussion of these is for instance in [Br06].)

Definition 4.3.48. Let $G = U(1) := \mathbb{R}/\mathbb{Z}$ and $n \in \mathbb{N}$, $n \geq 1$. Write $\mathbf{B}^{n-1}U(1) \in \infty\text{Grp}(\mathbf{H})$ for the topological *circle n -group*.

A $\mathbf{B}^{n-1}U(1)$ - n -gerbe we call a *circle n -gerbe*.

Proposition 4.3.49. *The automorphism ∞ -groups, def. 3.6.209, of the circle n -groups, def. 4.3.48, are given by the following crossed complexes (def. 1.2.90)*

$$\mathrm{AUT}(U(1)) \simeq [U(1) \xrightarrow{0} \mathbb{Z}_2],$$

$$\mathrm{AUT}(\mathbf{B}U(1)) \simeq [U(1) \xrightarrow{0} U(1) \xrightarrow{0} \mathbb{Z}_2].$$

Here \mathbb{Z}_2 acts on the $U(1)$ by the canonical action via $\mathbb{Z}_2 \simeq \mathrm{Aut}_{\mathrm{Grp}}(U(1))$.

The outer automorphism ∞ -groups, def. 3.6.267 are

$$\mathrm{Out}(U(1)) \simeq \mathbb{Z}_2;$$

$$\mathrm{Out}(\mathbf{B}U(1)) \simeq [U(1) \xrightarrow{0} \mathbb{Z}_2].$$

Hence both ∞ -groups are, of course, their own center.

With prop. 3.6.264 it follows that

$$\pi_0 U(1)\mathrm{Gerbe}(X) \simeq H^1(X, [U(1) \xrightarrow{0} \mathbb{Z}_2])$$

$$\pi_0 \mathbf{B}U(1)\mathrm{Gerbe}(X) \simeq H^1(X, [U(1) \xrightarrow{0} U(1) \xrightarrow{0} \mathbb{Z}_2]).$$

Notice that this classification is different (is richer) than that of $U(1)$ bundle gerbes and $U(1)$ bundle 2-gerbes. These are really models for $\mathbf{B}U(1)$ -principal 2-bundles and $\mathbf{B}^2U(1)$ -principal 3-bundles on X , and hence instead have the classification of prop. 3.6.167:

$$\pi_0 \mathbf{B}U(1)\mathrm{Bund}(X) \simeq H^1(X, [U(1) \rightarrow 1]) \simeq H^2(X, U(1)),$$

$$\pi_0 \mathbf{B}^2U(1)\mathrm{Bund}(X) \simeq H^1(X, [U(1) \rightarrow 1 \rightarrow 1]) \simeq H^3(X, U(1)).$$

Alternatively, this is the classification of the $U(1)$ -1-gerbes and $\mathbf{B}U(1)$ -2-gerbes with trivial band, def. 3.6.271, in $H^1(X, \mathrm{Out}(U(1)))$ and $H^1(X, \mathrm{Out}(\mathbf{B}U(1)))$.

$$\pi_0 U(1)\mathrm{Gerbe}_{*\in H^1(X, \mathrm{Out}(U(1)))}(X) \simeq H^2(X, U(1)),$$

$$\pi_0 \mathbf{B}U(1)\mathrm{Gerbe}_{*\in H^1(X, \mathrm{Out}(U(1)))}(X) \simeq H^3(X, U(1)).$$

4.3.11 Universal coverings and geometric Whitehead towers

We discuss geometric Whitehead towers (3.8.4) in $\mathrm{ETop}\infty\mathrm{Grpd}$.

Proposition 4.3.50. *Let X be a pointed paracompact topological space that admits a good open cover. Then its ordinary Whitehead tower $X^{(\infty)} \rightarrow \dots \rightarrow X^{(2)} \rightarrow X^{(1)} \rightarrow X^{(0)} = X$ in Top coincides with the image under the intrinsic fundamental ∞ -groupoid functor $|\Pi(-)|$ of its geometric Whitehead tower $* \rightarrow \dots \rightarrow X^{(2)} \rightarrow X^{(1)} \rightarrow X^{(0)} = X$ in $\mathrm{ETop}\infty\mathrm{Grpd}$:*

$$\begin{aligned} |\Pi(-)| : (X^{(\infty)} \rightarrow \dots \rightarrow X^{(2)} \rightarrow X^{(1)} \rightarrow X^{(0)} = X) &\in \mathrm{ETop}\infty\mathrm{Grpd} \\ \mapsto (* \rightarrow \dots \rightarrow X^{(2)} \rightarrow X^{(1)} \rightarrow X^{(0)} = X) &\in \mathrm{Top} \end{aligned}$$

Proof. The geometric Whitehead tower is characterized for each n by the fiber sequence

$$X^{(n)} \rightarrow X^{(n-1)} \rightarrow \mathbf{B}^n \pi_n(X) \rightarrow \mathbf{\Pi}_n(X) \rightarrow \mathbf{\Pi}_{(n-1)}(X).$$

By the above prop. 4.3.29 we have that $\mathbf{\Pi}_n(X) \simeq \mathrm{Disc}(\mathrm{Sing}X)$. Since Disc is right adjoint and hence preserves homotopy fibers this implies that $\mathbf{B}\pi_n(X) \simeq \mathbf{B}^n \mathrm{Disc}\pi_n(X)$, where $\pi_n(X)$ is the ordinary n th homotopy group of the pointed topological space X .

Then by prop. 4.3.47 we have that under $|\Pi(-)|$ the space $X^{(n)}$ maps to the homotopy fiber of $|\Pi(X^{(n-1)})| \rightarrow B^n |\mathrm{Disc}\pi_n(X)| = B^n \pi_n(X)$.

By induction over n this implies the claim. \square

4.4 Smooth ∞ -groupoids

We discuss *smooth* cohesion.

Definition 4.4.1. Write SmoothMfd for the category whose objects are smooth manifolds that are

- finite-dimensional;
- paracompact;
- with arbitrary set of connected components;

and whose morphisms are smooth functions between these.

Notice the evident forgetful functor

$$i : \text{SmoothMfd} \rightarrow \text{TopMfd}$$

to the category of topological manifolds, from def. 4.3.6.

Definition 4.4.2. For $X \in \text{SmoothMfd}$, say an open cover $\{U_i \rightarrow X\}$ is a *differentiably good open cover* if each non-empty finite intersection of the U_i is *diffeomorphic* to a Cartesian space \mathbb{R}^n .

Proposition 4.4.3. *Every paracompact smooth manifold admits a differentiably good open cover.*

Proof. This is a folk theorem. A detailed proof is in the appendix of [FSS10]. □
 Notice that the statement here is a bit stronger than the familiar statement about topologically good open covers, where the intersections are only required to be homeomorphic to a ball.

Definition 4.4.4. Regard SmoothMfd as a large site equipped with the coverage of differentiably good open covers. Write $\text{CartSp}_{\text{smooth}} \hookrightarrow \text{SmoothMfd}$ for the full sub-site on Cartesian spaces.

Observation 4.4.5. Differentiably good open covers do indeed define a coverage and the Grothendieck topology generated from it is the standard open cover topology.

Proof. For X a paracompact smooth manifold, $\{U_i \rightarrow X\}$ an open cover and $f : Y \rightarrow X$ any smooth function from a paracompact manifold Y , the inverse images $\{f^{-1}(U_i) \rightarrow Y\}$ form an open cover of Y . Since $\coprod_i f^{-1}(U_i)$ is itself a paracompact smooth manifold, there is a differentiably good open cover $\{K_j \rightarrow \coprod_i U_i\}$, hence a differentiably good open cover $\{K_j \rightarrow Y\}$ such that for all j there is an $i(j)$ such that we have a commuting square

$$\begin{array}{ccc} K_j & \longrightarrow & U_{i(j)} \\ \downarrow & & \downarrow \\ Y & \xrightarrow{f} & X \end{array} .$$

□

Proposition 4.4.6. $\text{CartSp}_{\text{smooth}}$ is an ∞ -cohesive site.

Proof. By the same kind of argument as in prop. 4.3.2. □

Definition 4.4.7. The ∞ -topos of *smooth ∞ -groupoids* is the ∞ -sheaf ∞ -topos on $\text{CartSp}_{\text{smooth}}$:

$$\text{Smooth}\infty\text{Grpd} := \text{Sh}_{\infty}(\text{CartSp}_{\text{smooth}}) .$$

Since $\text{CartSp}_{\text{smooth}}$ is similar to the site $\text{CartSp}_{\text{top}}$ from def. 4.3.1, various properties of $\text{Smooth}\infty\text{Grpd}$ are immediate analogs of the corresponding properties of $\text{ETop}\infty\text{Grpd}$ from def. 4.3.3.

Proposition 4.4.8. *Smooth ∞ Grpd is a cohesive ∞ -topos.*

Proof. With prop. 4.4.6 this follows by prop. 3.4.18. □

Proposition 4.4.9. *Smooth ∞ Grpd is equivalent to the hypercompletion of the ∞ -sheaf ∞ -topos over SmoothMfd:*

$$\text{Smooth}\infty\text{Grpd} \simeq \hat{\text{Sh}}_{\infty}(\text{SmoothMfd}).$$

Proof. Observe that $\text{CartSp}_{\text{smooth}}$ is a small dense sub-site of SmoothMfd. With this the claim follows as in prop. 4.3.7. □

Corollary 4.4.10. *The canonical embedding of smooth manifolds as 0-truncated objects of Smooth ∞ Grpd extends to a full and faithful ∞ -functor*

$$\text{SmoothMfd} \hookrightarrow \text{Smooth}\infty\text{Grpd}.$$

Proof. With prop. 4.4.9 this follows from the ∞ -Yoneda lemma. □

Remark 4.4.11. By example 2.2.21 there is an equivalence of ∞ -categories

$$\text{Smooth}\infty\text{Grpd} \simeq L_W \text{SmthMfd}^{\Delta^{\text{op}}},$$

where on the right we have the simplicial localization of the category of simplicial smooth manifolds (with arbitrary set of connected components) at the stalkwise weak equivalences.

This says that every smooth ∞ -groupoid has a presentation by a simplicial smooth manifold (not in general a locally Kan simplicial manifold, though) and that this identification is even homotopy-full and faithful.

Consider the canonical forgetful functor

$$i : \text{CartSp}_{\text{smooth}} \rightarrow \text{CartSp}_{\text{top}}$$

to the site of definition for the cohesive ∞ -topos $\text{ETop}\infty\text{Grpd}$ of Euclidean-topological ∞ -groupoids, def. 4.3.3.

Proposition 4.4.12. *The functor i extends to an essential geometric morphism*

$$(i_! \dashv i^* \dashv i_*) : \text{Smooth}\infty\text{Grpd} \begin{array}{c} \xrightarrow{i_!} \\ \xleftarrow{i^*} \\ \xrightarrow{i_*} \end{array} \text{ETop}\infty\text{Grpd}$$

such that the ∞ -Yoneda embedding is factored through the induced inclusion $\text{SmoothMfd} \xrightarrow{i} \text{Mfd}$ as

$$\begin{array}{ccc} \text{SmoothMfd}^{\mathbb{C}} & \longrightarrow & \text{Smooth}\infty\text{Grpd} \\ \downarrow i & & \downarrow i_! \\ \text{Mfd}^{\mathbb{C}} & \longrightarrow & \text{ETop}\infty\text{Grpd} \end{array}$$

Proof. Using the observation that i preserves coverings and pullbacks along morphism in covering families, the proof follows the steps of the proof of prop. 3.5.3. \square

Corollary 4.4.13. *The essential global section ∞ -geometric morphism of $\text{Smooth}\infty\text{Grpd}$ factors through that of $\text{ETop}\infty\text{Grpd}$*

$$(\Pi_{\text{Smooth}} \dashv \text{Disc}_{\text{Smooth}} \dashv \Gamma_{\text{Smooth}}) : \text{Smooth}\infty\text{Grpd} \begin{array}{c} \xrightarrow{i_!} \\ \xleftarrow{i^*} \\ \xrightarrow{i_*} \end{array} \text{ETop}\infty\text{Grpd} \begin{array}{c} \xrightarrow{\Pi_{\text{ETop}}} \\ \xleftarrow{\text{Disc}_{\text{ETop}}} \\ \xrightarrow{\Gamma_{\text{ETop}}} \end{array} \infty\text{Grpd}$$

Proof. This follows from the essential uniqueness of the global section ∞ -geometric morphism, prop 2.2.4, and of adjoint ∞ -functors. \square

The functor $i_!$ here is the forgetful functor that *forgets smooth structure* and only *remembers Euclidean topology-structure*.

We now discuss the various general abstract structures in a cohesive ∞ -topos, 3.9, realized in $\text{Smooth}\infty\text{Grpd}$.

- 4.4.1 – Concrete objects
- 4.4.2 – Groups
- 4.4.3 – Groupoids
- 4.4.4 – Geometric homotopy
- 4.4.5 – Paths and geometric Postnikov towers
- 4.4.6 – Cohomology
- 4.4.7 – Principal ∞ -bundles
- 4.4.8 – Twisted cohomology
- 4.4.9 – ∞ -Group representations
- 4.4.10 – Associated bundles
- 4.4.11 – Manifolds
- 4.4.12 – Flat ∞ -connections and local systems
- 4.4.13 – de Rham cohomology
- 4.4.14 – Exponentiated ∞ -Lie algebras
- 4.4.15 – Maurer-Cartan forms and curvature characteristic forms
- 4.4.16 – Differential cohomology
- 4.4.17 – ∞ -Chern-Weil homomorphism
- 4.4.18 – Higher holonomy
- 4.4.19 – ∞ -Chern-Simons functionals
- 4.4.20 – Prequantum geometry

4.4.1 Concrete objects

We discuss the general notion of *concrete objects* in a cohesive ∞ -topos, 3.7.2, realized in $\text{Smooth}\infty\text{Grpd}$.

The following definition generalizes the notion of smooth manifold and has been used as a convenient context for differential geometry. It goes back to [Sou79] and, in a slight variant, to [Chen77]. The formulation of differential geometry in this context is carefully exposed in [Ig13]. The sheaf-theoretic formulation of the definition that we state is amplified in [BaHo09].

Definition 4.4.14. A sheaf X on $\text{CartSp}_{\text{smooth}}$ is a *diffeological space* if it is a *concrete sheaf* in the sense of [Dub79]: if for every $U \in \text{CartSp}_{\text{smooth}}$ the canonical function

$$X(U) \simeq \text{Sh}(U, X) \xrightarrow{\Gamma} \text{Set}(\Gamma(U), \Gamma(X))$$

is an injection.

The following observations are due to [CaSc].

Proposition 4.4.15. Write $\text{Conc}(\text{Smooth}\infty\text{Grpd})_{\leq 0}$ for the full subcategory on the 0-truncated concrete objects, according to def. 3.7.7. This is equivalent to the full subcategory of $\text{Sh}(\text{CartSp}_{\text{smooth}})$ on the diffeological spaces:

$$\text{DiffeolSpace} \simeq \text{Conc}(\text{Smooth}\infty\text{Grpd})_{\leq 0}.$$

Proof. Let $X \in \text{Sh}(\text{CartSp}_{\text{smooth}}) \hookrightarrow \text{Smooth}\infty\text{Grpd}$ be a sheaf. The condition for it to be a concrete object according to def. 3.7.7 is that the $(\Gamma \dashv \text{coDisc})$ -unit

$$X \rightarrow \text{coDisc}\Gamma X$$

is a monomorphism. Since monomorphisms of sheaves are detected objectwise this is equivalent to the statement that for all $U \in \text{CartSp}_{\text{smooth}}$ the morphism

$$X(U) \simeq \text{Smooth}\infty\text{Grpd}(U, X) \rightarrow \text{Smooth}\infty\text{Grpd}(U, \text{coDisc}\Gamma X) \simeq \infty\text{Grpd}(\Gamma U, \Gamma X)$$

is a monomorphism of sets, where in the first step we used the ∞ -Yoneda lemma and in the last one the $(\Gamma \dashv \text{coDisc})$ -adjunction. This is manifestly the defining condition for concrete sheaves that define diffeological spaces. \square

Corollary 4.4.16. The canonical embedding $\text{SmoothMfd} \hookrightarrow \text{Smooth}\infty\text{Grpd}$ from prop. 4.4.10 factors through diffeological spaces: we have a sequence of full and faithful ∞ -functors

$$\text{SmoothMfd} \hookrightarrow \text{DiffeolSpace} \hookrightarrow \text{Smooth}\infty\text{Grpd}.$$

Definition 4.4.17. Write $\text{DiffeolGrpd} \hookrightarrow \text{SmoothGrpd}$ for the full sub- ∞ -category on those smooth ∞ -groupoids that are represented by a groupoid object internal to diffeological spaces.

Proposition 4.4.18. There is a canonical equivalence

$$\text{DiffeolGrpd} \simeq \text{Conc}(\text{Smooth}\infty\text{Grpd})_{\leq 1}$$

identifying diffeological groupoids with the concrete 1-truncated smooth ∞ -groupoids.

Proof. By definition, an object $X \in \text{Smooth}\infty\text{Grpd}$ is concrete precisely if there exists a 0-concrete object U , and an effective epimorphism $U \rightarrow X$ such that $U \times_X U$ is itself 0-concrete. By prop. 4.4.15 both U and $U \times_X U$ are equivalent to diffeological spaces. Therefore the groupoid object $(U \times_X U \rightrightarrows U)$ internal to $\text{Smooth}\infty\text{Grpd}$ comes from a groupoid object internal to diffeological spaces. By Giraud's axioms for ∞ -toposes, X is equivalent to (the ∞ -colimit over) this groupoid object:

$$X \simeq \lim_{\rightarrow} (U \times_X U \rightrightarrows U).$$

\square

4.4.2 Groups

We discuss some cohesive ∞ -group objects, according to 3.6.8, in $\text{Smooth}\infty\text{Grpd}$.

Let $G \in \text{SmoothMfd}$ be a Lie group. Under the embedding $\text{SmoothMfd} \hookrightarrow \text{Smooth}\infty\text{Grpd}$ this is canonically identified as a 0-truncated ∞ -group object in $\text{Smooth}\infty\text{Grpd}$. Write $\mathbf{B}G \in \text{Smooth}\infty\text{Grpd}$ for the corresponding delooping object.

Proposition 4.4.19. *A fibrant presentation of the delooping object $\mathbf{B}G$ in the projective local model structure on simplicial presheaves $[\mathrm{CartSp}_{\mathrm{smooth}}^{\mathrm{op}}, \mathrm{sSet}]_{\mathrm{proj}, \mathrm{loc}}$ is given by the simplicial presheaf that is the nerve of the one-object Lie groupoid*

$$\mathbf{B}G_{\mathrm{ch}} := (G \rightrightarrows *)$$

regarded as a simplicial manifold and canonically embedded into simplicial presheaves:

$$\mathbf{B}G_{\mathrm{ch}} : U \mapsto N(C^\infty(U, G) \rightrightarrows *).$$

Proof. This is essentially a special case of prop. 4.3.13. The presheaf is clearly objectwise a Kan complex, being objectwise the nerve of a groupoid. It satisfies descent along good open covers $\{U_i \rightarrow \mathbb{R}^n\}$ of Cartesian spaces, because the descent ∞ -groupoid $[\mathrm{CartSp}_{\mathrm{smooth}}^{\mathrm{op}}, \mathrm{sSet}](C(\{U_i\}), \mathbf{B}G)$ is $\cdots \simeq G\mathrm{Bund}(\mathbb{R}^n) \simeq G\mathrm{TrivBund}(\mathbb{R}^n)$: an object is a Čech 1-cocycle with coefficients in G , a morphism a Čech coboundary. This yields the groupoid of G -principal bundles over U , which for the Cartesian space U is however equivalent to the groupoid of trivial G -bundles over U .

To show that $\mathbf{B}G$ is indeed the delooping object of G it is sufficient by prop. 2.3.13 to compute the ∞ -pullback $G \simeq * \times_{\mathbf{B}G} * \in \mathrm{Smooth}\infty\mathrm{Grpd}$ in the global model structure $[\mathrm{CartSp}^{\mathrm{op}}, \mathrm{sSet}]_{\mathrm{proj}}$. This is accomplished by the ordinary pullback of the fibrant replacement diagram

$$\begin{array}{ccc} G & \longrightarrow & N(G \times G \begin{array}{c} \xrightarrow{p_1, p_2} \\ \xrightarrow{p_1} \end{array} G) \\ \downarrow & & \downarrow p_2 \\ * & \longrightarrow & N(G \rightrightarrows *) \end{array}$$

□

Proposition 4.4.20. *For G a Lie group, $\mathbf{B}G$ is a 1-concrete object in \mathbf{H} .*

Proof. Since $\mathbf{B}G_{\mathrm{ch}}$ is fibrant in $[\mathrm{CartSp}^{\mathrm{op}}, \mathrm{sSet}]_{\mathrm{proj}, \mathrm{loc}}$ and since G presents a concrete sheaf, this follows with prop. 3.7.8. □

Definition 4.4.21. Write equivalently

$$U(1) = S^1 = \mathbb{R}/\mathbb{Z}$$

for the *circle Lie group*, regarded as a 0-truncated ∞ -group object in $\mathrm{Smooth}\infty\mathrm{Grpd}$ under the embedding prop. 4.4.10.

For $n \in \mathbb{N}$ the n -fold delooping $\mathbf{B}^n U(1) \in \mathrm{Smooth}\infty\mathrm{Grpd}$ we call the *circle Lie $(n+1)$ -group*.

Write

$$U(1)[n] := [\cdots \rightarrow 0 \rightarrow C^\infty(-, U(1)) \rightarrow 0 \rightarrow \cdots \rightarrow 0] \in [\mathrm{CartSp}_{\mathrm{smooth}}^{\mathrm{op}}, \mathrm{Ch}_{\bullet \geq 0}]$$

for the chain complex of sheaves concentrated in degree n on $U(1)$. Recall the right Quillen functor $\Xi : [\mathrm{CartSp}_{\mathrm{smooth}}^{\mathrm{op}}, \mathrm{Ch}^+]_{\mathrm{proj}} \rightarrow [\mathrm{CartSp}_{\mathrm{smooth}}^{\mathrm{op}}, \mathrm{sSet}]_{\mathrm{proj}}$ from prop. 2.2.31.

Proposition 4.4.22. *The simplicial presheaf $\Xi(U(1)[n])$ is a fibrant representative in $[\mathrm{CartSp}_{\mathrm{smooth}}^{\mathrm{op}}, \mathrm{sSet}]_{\mathrm{proj}, \mathrm{loc}}$ of the circle Lie $(n+1)$ -group $\mathbf{B}^n U(1)$.*

Proof. First notice that since $U(1)[n]$ is fibrant in $[\mathrm{CartSp}_{\mathrm{smooth}}^{\mathrm{op}}, \mathrm{Ch}_{\bullet}]_{\mathrm{proj}}$ we have that $\Xi U(1)[n]$ is fibrant in the global model structure $[\mathrm{CartSp}^{\mathrm{op}}, \mathrm{sSet}]_{\mathrm{proj}}$. By prop. 2.3.13 we may compute the ∞ -pullback that defines the loop space object in $\mathrm{Smooth}\infty\mathrm{Grpd}$ in terms of a homotopy pullback in this global model structure.

To that end, consider the global fibration resolution of the point inclusion $*$ $\rightarrow \Xi(U(1)[n])$ given under Ξ by the morphism of chain complexes

$$\begin{array}{ccccccc} [C^\infty(-, U(1)) & \xrightarrow{\text{Id}} & C^\infty(-, U(1)) & \longrightarrow & 0 & \longrightarrow & \cdots & \longrightarrow & 0] \\ \downarrow \text{Id} & & \downarrow & & \downarrow & & & & \downarrow \\ [C^\infty(-, U(1)) & \longrightarrow & 0 & \longrightarrow & 0 & \longrightarrow & \cdots & \longrightarrow & 0] \end{array} .$$

The underlying morphism of chain complexes is clearly degreewise surjective, hence a projective fibration, hence its image under Ξ is a projective fibration. Therefore the homotopy pullback in question is given by the ordinary pullback

$$\begin{array}{ccc} \Xi[0 \rightarrow C^\infty(-, U(1)) \rightarrow 0 \rightarrow \cdots \rightarrow 0] & \longrightarrow & \Xi[C^\infty(-, U(1)) \xrightarrow{\text{Id}} C^\infty(-, U(1)) \rightarrow 0 \rightarrow \cdots \rightarrow 0] \\ \downarrow & & \downarrow \\ \Xi[0 \rightarrow 0 \rightarrow 0 \rightarrow \cdots \rightarrow 0] & \longrightarrow & \Xi[C^\infty(-, U(1)) \rightarrow 0 \rightarrow 0 \rightarrow \cdots \rightarrow 0] \end{array}$$

computed in $[\text{CartSp}^{\text{op}}, \text{Ch}^+]$ and then using that Ξ is the right adjoint and hence preserves pullbacks. This shows that the loop object $\Omega \Xi(U(1)[n])$ is indeed presented by $\Xi(U(1)[n-1])$.

Now we discuss the fibrancy of $U(1)[n]$ in the local model structure. We need to check that for all differentiably good open covers $\{U_i \rightarrow U\}$ of a Cartesian space U we have that the morphism

$$C^\infty(U, U(1))[n] \rightarrow [\text{CartSp}^{\text{op}}, \text{sSet}](C(\{U_i\}), \Xi(U(1)[n]))$$

is an equivalence of Kan complexes, where $C(\{U_i\})$ is the Čech nerve of the cover. Observe that the Kan complex on the right is that whose vertices are cocycles in degree- n Čech cohomology (see [FSS10] for more on this) with coefficients in $U(1)$ and whose morphisms are coboundaries between these.

We proceed by induction on n . For $n = 0$ the condition is just that $C^\infty(-, U(1))$ is a sheaf, which clearly it is. For general n we use that since $C(\{U_i\})$ is cofibrant, the above is the derived hom-space functor which commutes with homotopy pullbacks and hence with forming loop space objects, so that

$$\pi_1[\text{CartSp}_{\text{smooth}}^{\text{op}}, \text{sSet}](C(\{U_i\}), \Xi(U(1)[n])) \simeq \pi_0[\text{CartSp}_{\text{smooth}}^{\text{op}}, \text{sSet}](C(\{U_i\}), \Xi(U(1)[n-1]))$$

by the above result on delooping. So we find that for all $0 \leq k \leq n$ that $\pi_k[\text{CartSp}^{\text{op}}, \text{sSet}](C(\{U_i\}), \Xi(U(1)[n]))$ is the Čech cohomology of U with coefficients in $U(1)$ in degree $n - k$. By standard facts about Čech cohomology (using the short exact sequence of abelian groups $\mathbb{Z} \rightarrow U(1) \rightarrow \mathbb{R}$ and the fact that the cohomology with coefficients in \mathbb{R} vanishes in positive degree, for instance by a partition of unity argument) we have that this is given by the integral cohomology groups

$$\pi_0[\text{CartSp}^{\text{op}}, \text{sSet}](C(\{U_i\}), \Xi(U(1)[n])) \simeq H^{n+1}(U, \mathbb{Z})$$

for $n \geq 1$. For the contractible Cartesian space all these cohomology groups vanish.

So we find that $\Xi(U(1)[n])(U)$ and $[\text{CartSp}_{\text{smooth}}^{\text{op}}, \text{sSet}](C(\{U_i\}), \Xi(U(1)[n]))$ both have homotopy groups concentrated in degree n on $U(1)$. The above looping argument together with the fact that $U(1)$ is a sheaf also shows that the morphism in question is an isomorphism on this degree- n homotopy group, hence is indeed a weak homotopy equivalence. \square

Notice that in the equivalent presentation of $\text{Smooth}\infty\text{Grpd}$ by simplicial presheaves on the large site SmoothMfd the objects $\Xi(U(1)[n])$ are far from being locally fibrant. Instead, their locally fibrant replacements are given by the n -stacks of circle n -bundles.

4.4.3 Groupoids

We discuss aspects of the general abstract theory of *groupoid objects*, 3.6.7, realized in the context of smooth cohesion.

4.4.3.1 Group of bisections We discuss the general notion of groups of bisections of 3.6.7.1.2, realized in smooth cohesion.

Let

$$X = X_1 \rightrightarrows X_0 \in \text{Grpd}(\text{SmthMfd}) \hookrightarrow \text{Smooth}\infty\text{Grpd}$$

be a Lie groupoid, regarded canonically as smooth ∞ -groupoid and equipped with the atlas given by the canonical inclusion

$$i_X : X_0 \longrightarrow X$$

of the manifold of objects.

Proposition 4.4.23. *The group of bisections $\mathbf{BiSect}_X(X_0) \in \text{Grp}(\text{Smooth}\infty\text{Grpd})$ of this groupoid object, according to def. 3.6.95, is equivalent to the traditional diffeological group of bisections of Lie groupoid theory and the canonical morphism of def. 3.6.97.*

Proof. First observe that the hom-groupoid $\mathbf{Smooth}\infty\text{Grpd}_X(X_0, X_0)$ is equivalently given by that of $\text{Grpd}(\text{SmoothMfd})_{/X}(X_0, X_0)$. This follows for instance from prop. 3.6.5, according to which we have a homotopy pullback diagram

$$\begin{array}{ccc} \mathbf{H}_{/X}(U \times X_0, X_0) & \longrightarrow & \mathbf{H}(U \times X_0, X_0) \\ \downarrow & & \downarrow \mathbf{H}(U \times X_0, i_X) \\ * & \xrightarrow{\vdash i_X} & \mathbf{H}(U \times X_0, X) \end{array}$$

for each $U \in \text{CartSp} \hookrightarrow \text{Smooth}\infty\text{Grpd}$. Here the top right morphism set is equivalent to $\text{SmoothMfd}(U \times X_0, X_0)$. The bottom right morphism set is a priori given by morphisms out of the Cech nerve of a good open over of $U \times X_0$. But since the right and bottom morphism both hit elements in there which come from direct maps out of $U \times X_0$, also the gauge transformations between them are given by globally defined smooth functions $U \times X_0 \rightarrow X_1$.

With this now it remains to observe that a diagram

$$\begin{array}{ccc} U \times X_0 & \xrightarrow{\phi} & X_0 \\ & \swarrow \text{=} & \downarrow i_X \\ & & X_0 \\ & \searrow i_X & \swarrow i_X \\ & & X_0 \end{array}$$

of smooth groupoids is equivalently

1. a smoothly U -parameterized collection of smooth function $\phi_u : X_0 \rightarrow X_0$;
2. for each such a smooth choice of morphisms $x \rightarrow \phi(x)$ in X_1 for all $x \in x_0$.

This is precisely the traditional description of the group of bisections of X . □

4.4.3.2 Atiyah groupoids We discuss the general notion of Atiyah groupoids, 3.6.7.1.3, realized in smooth cohesion.

Let $G \in \text{Grp}(\text{Top}) \hookrightarrow \text{Grp}(\text{Smooth}\infty\text{Grpd})$ be a Lie group, and write $\mathbf{BG} \in \text{ETop}\infty\text{Grpd}$ for its internal delooping, as in 4.4.2 above. Let $X \in \text{SmthMfd} \hookrightarrow \text{Smooth}\infty\text{Grpd}$ be a smooth manifold. Let $P \rightarrow X$ be any G -principal bundle over X and write $g : X \rightarrow \mathbf{BG}$ for the, essentially unique, morphism that modulates it (discussed in more detail in 4.4.7 below).

The following definition is traditional

Definition 4.4.24. The *Atiyah Lie groupoid* of the G -principal bundle $P \rightarrow X$ is the Lie groupoid

$$\text{At}(P) := \left(P \times_G P \rightrightarrows X \right),$$

with composition defined by the evident composition of pairs of representatives. $[s_2, s_3] \circ [s_1, s_2] := [s_1, s_3]$.

Remark 4.4.25. Here $P \times_{U(1)} P = (P \times P)/U(1)$ is the quotient of the cartesian product of the total space of the bundle with itself by the diagonal action of G on both factors. So if $(x_1, x_2) \in X \times X$ is fixed then the morphisms in $\text{At}(P)_{x_1, x_2}$ with this source and target form the space $(P_{x_1} \times P_{x_2})/G$. But this is canonically isomorphic to the space of G -torsor homomorphisms (over the point) $P_{x_1} \rightarrow P_{x_2}$:

$$\text{At}(P)_{x_1, x_2} = G\text{Tor}(P_{x_1}, P_{x_2}).$$

We now discuss that this traditional construction is indeed a special case of the general discussion in 3.6.7.1.3.

Proposition 4.4.26. For $P \rightarrow X$ a smooth G -principal bundle with modulating map $g : X \rightarrow \mathbf{BG}$ as above, its Atiyah groupoid in $\text{Smooth}\infty\text{Grpd}$ in the sense of def. 3.6.104 is canonically represented by the traditional Atiyah groupoid construction of def. 4.4.24, under the canonical embedding $\text{LieGrpd} \rightarrow \text{Smooth}\infty\text{Grpd}$.

Proof. By prop. 3.6.40 we have that $\text{im}_1(g)$ is given by the ∞ -colimit over its Čech nerve. Since $X \in \text{Smooth}\infty\text{Grpd}$ is 0-truncated and $\mathbf{BG} \in \text{Smooth}\infty\text{Grpd}$ is 1-truncated, this Čech nerve is given by a 2-coskeletal simplicial smooth manifold:

$$\text{im}_1(g) \simeq \varinjlim \left(\cdots \rightrightarrows_{\mathbf{BG}} X \times X \rightrightarrows X \right).$$

Therefore by prop. 2.3.21 this simplicial diagram, regarded under the embedding $\text{SmthMfd}^{\Delta^{\text{op}}} \rightarrow \text{Smooth}\infty\text{Grpd}$, is equivalently the 1-image of g . It is then sufficient to observe that

$$X \times_{\mathbf{BG}} X \simeq P \times_G P.$$

To see this, observe that (since the ∞ -hom functor $\mathbf{H}(U, -)$ preserves homotopy limits) for every $U \in \text{CartSp}$ the U -plots of the object on the left are equivalently pairs of smooth functions $r, l : U \rightarrow X$ equipped with a morphism of G -principal bundles $l^*P \rightarrow r^*P$. By remark 4.4.25 this are equivalently the U -plots of $P \times_G P$. \square

4.4.4 Geometric homotopy

We discuss the intrinsic fundamental ∞ -groupoid construction, 3.8.1, and the induced notion of geometric realization, realized in $\text{Smooth}\infty\text{Grpd}$.

4.4.4.1 Geometric realization of simplicial smooth spaces

Proposition 4.4.27. If $X \in \text{Smooth}\infty\text{Grpd}$ is presented by $X_{\bullet} \in \text{SmoothMfd}^{\Delta^{\text{op}}} \hookrightarrow [\text{CartSp}_{\text{smooth}}^{\text{op}}, \text{sSet}]$, then its image $i_!(X) \in \text{ETop}\infty\text{Grpd}$ under the relative topological cohesion morphism, prop. 4.4.12, is presented by the underlying simplicial topological space $X_{\bullet} \in \text{TopMfd}^{\Delta^{\text{op}}} \hookrightarrow [\text{CartSp}_{\text{top}}^{\text{op}}, \text{sSet}]$.

Proof. Let first $X \in \text{SmoothMfd} \hookrightarrow \text{SmoothMfd}^{\Delta^{\text{op}}}$ be simplicially constant. Then there is a differentiably good open cover, 4.4.3, $\{U_i \rightarrow X\}$ such that the Čech nerve projection

$$\left(\int^{\int^{[k] \in \Delta}} \Delta[k] \cdot \prod_{i_0, \dots, i_k} U_{i_0} \times_X \cdots \times_X U_{i_k} \right) \xrightarrow{\cong} X$$

is a cofibrant resolution in $[\text{CartSp}_{\text{smooth}}^{\text{op}}, \text{sSet}]_{\text{proj, loc}}$ which is degreewise a coproduct of representables. That means that the left derived functor $\mathbb{L}\text{Lan}_i$ on X is computed by the application of Lan_i on this coend, which by the fact that this is defined to be the left Kan extension along i is given degreewise by i , and since i preserves pullbacks along covers, this is

$$\begin{aligned} (\mathbb{L}\text{Lan}_i)X &\simeq \text{Lan}_i \left(\int^{\int^{[k] \in \Delta}} \Delta[k] \cdot \prod_{i_0, \dots, i_k} U_{i_0} \times_X \cdots \times_X U_{i_k} \right) \\ &= \int^{\int^{[k] \in \Delta}} \Delta[k] \cdot \prod_{i_0, \dots, i_k} \text{Lan}_i(U_{i_0} \times_X \cdots \times_X U_{i_k}) \\ &\simeq \int^{\int^{[k] \in \Delta}} \Delta[k] \cdot \prod_{i_0, \dots, i_k} i(U_{i_0} \times_X \cdots \times_X U_{i_k}) \\ &\simeq \int^{\int^{[k] \in \Delta}} \Delta[k] \cdot \prod_{i_0, \dots, i_k} (i(U_{i_0}) \times_{i(X)} \cdots \times_{i(X)} i(U_{i_k})) \\ &\simeq i(X) \end{aligned}$$

The last step follows from observing that we have manifestly the Čech nerve as before, but now of the underlying topological spaces of the $\{U_i\}$ and of X .

The claim then follows for general simplicial spaces by observing that $X_{\bullet} = \int^{[k] \in \Delta} \Delta[k] \cdot X_k \in [\text{CartSp}_{\text{smooth}}^{\text{op}}, \text{sSet}]_{\text{proj, loc}}$ presents the ∞ -colimit over $X_{\bullet} : \Delta^{\text{op}} \rightarrow \text{SmoothMfd} \hookrightarrow \text{Smooth}\infty\text{Grpd}$ and the left adjoint ∞ -functor $i!$ preserves these. \square

Corollary 4.4.28. *If $X \in \text{Smooth}\infty\text{Grpd}$ is presented by $X_{\bullet} \in \text{SmoothMfd}^{\Delta^{\text{op}}} \hookrightarrow [\text{CartSp}_{\text{smooth}}^{\text{op}}, \text{sSet}]$, then the image of X under the fundamental ∞ -groupoid functor, 3.8.1,*

$$\text{Smooth}\infty\text{Grpd} \xrightarrow{\Pi} \infty\text{Grpd} \xrightarrow[\simeq]{|-|} \text{Top}$$

is weakly homotopy equivalent to the geometric realization of (a Reedy cofibrant replacement of) the underlying simplicial topological space

$$|\Pi(X)| \simeq |QX_{\bullet}|.$$

In particular if X is an ordinary smooth manifold then

$$\Pi(X) \simeq \text{Sing}X$$

is equivalent to the standard fundamental ∞ -groupoid of X .

Proof. By prop. 4.4.13 the functor Π factors as $\Pi X \simeq \Pi_{\text{ETop}} i! X$. By prop. 4.4.27 this is Π_{ETop} applied to the underlying simplicial topological space. The claim then follows with prop. 4.3.30. \square

Corollary 4.4.29. *The ∞ -functor $\Pi : \text{Smooth}\infty\text{Grpd} \rightarrow \infty\text{Grpd}$ preserves homotopy fibers of morphisms that are presented in $[\text{CartSp}_{\text{smooth}}^{\text{op}}, \text{sSet}]_{\text{proj}}$ by morphisms of the form $X \rightarrow \bar{W}G$ with X fibrant and G a simplicial group in SmoothMfd .*

Proof. By prop. 4.4.13 the functor factors as $\Pi_{\text{Smooth}} \simeq \Pi_{\text{ETop}} \circ i_!$. By prop. 4.4.27 $i_!$ assigns the underlying topological spaces. If we can show that this preserves the homotopy fibers in question, then the claim follows with prop. 4.3.47. We find this as in the proof of the latter proposition, by considering the pasting diagram of pullbacks of simplicial presheaves

$$\begin{array}{ccccc} P' & \xrightarrow{\simeq} & P & \longrightarrow & WG \\ \downarrow & & \downarrow & & \downarrow \\ QX & \xrightarrow{\simeq} & X & \longrightarrow & \bar{W}G \end{array} .$$

Since the component maps of the right vertical morphisms are surjective, the degreewise pullbacks in SmoothMfd that define P' are all along transversal maps, and thus the underlying objects in TopMfd are the pullbacks of the underlying topological manifolds. Therefore the degreewise forgetful functor $\text{SmoothMfd} \rightarrow \text{TopMfd}$ presents $i_!$ on the outer diagram and sends this homotopy pullback to a homotopy pullback. \square

4.4.4.2 Co-Tensoring of smooth ∞ -Stacks over homotopy types of manifolds

Example 4.4.30. There is a natural equivalence $[\Pi(S^1), X] \cong \mathcal{L}X$ between the moduli stack of maps from the homotopy type of the circle S^1 to X and the *free loop space object* of X . Namely, the free loop space object $\mathcal{L}X$ is defined as the homotopy pullback of its diagonal map along itself

$$\mathcal{L}X := X \times_{X \times X} X ,$$

i.e., as the object defined by the homotopy pullback diagram

$$\begin{array}{ccc} \mathcal{L}X & \longrightarrow & X \\ \downarrow & & \downarrow \Delta_X \\ X & \xrightarrow{\Delta_X} & X \times X \end{array} .$$

One then notices that S^1 is obtained by gluing two segments (which are contractible) along their endpoints, which amount to saying that at the level of homotopy types we have an equivalence

$$\Pi(S^1) \simeq * \coprod_{* \amalg *} * ,$$

and uses the fact that $[-, X]$ preserves homotopy limits. Here the top \amalg denotes pushout, while the bottom one denotes disjoint union (itself viewed as an instance of a pushout). One can similarly see that the ∞ -groupoid corresponding to the 2-sphere S^2 can be viewed as

$$\Pi(S^2) \simeq * \coprod_{* \amalg *} * .$$

One can iterate in an obvious way to get the higher cases.

The above example immediately generalizes from circles to arbitrary n -spheres.

Definition 4.4.31. For X an object in \mathbf{H} and for $n \in \mathbb{N}$, the *free n -sphere space object* of X is

$$[\Pi(S^n), X] .$$

An $(n + 1)$ -sphere is obtained by gluing two $(n + 1)$ -disks along their common boundary, which is an n -sphere. Since the disks are contractible, from a homotopy type point of view, this amounts to the natural equivalence

$$\Pi(S^{n+1}) \simeq * \coprod_{\Pi(S^n)} * .$$

Applying the internal homs to X to this equivalence and recalling that $[-, X]$ preserves homotopy limits, one obtains the following result.

Proposition 4.4.32. *For all $n \in \mathbb{N}$ we have a natural homotopy pullback square*

$$\begin{array}{ccc} [\Pi(S^{n+1}), X] & \longrightarrow & X \\ \downarrow & & \downarrow \\ X & \longrightarrow & [\Pi(S^n), X] . \end{array}$$

Proof. We may use that for all n we have

$$\Pi(S^{n+1}) \simeq * \coprod_{\Pi(S^n)} * .$$

From this the statement follows by using that $[-, X] : \mathbf{H}^{\text{op}} \rightarrow \mathbf{H}$ preserves homotopy limits. The above statement is standard, one can see it for instance by presenting the situation in the standard model structure on simplicial sets, there replacing one of the maps from the n -sphere to the point by the cofibration given by the inclusion of the n -sphere as the boundary of the $(n + 1)$ -disk, and finally computing the ordinary (1-categorical) cofiber of that. \square

4.4.5 Paths and geometric Postnikov towers

We discuss the general abstract notion of path ∞ -groupoid, 3.8.3, realized in $\text{Smooth}\infty\text{Grpd}$.

The presentation of $\mathbf{\Pi}(X)$ in $\text{ETop}\infty\text{Grpd}$, 4.3.7 has a direct refinement to smooth cohesion:

Definition 4.4.33. For $X \in \text{SmthMfd}$ write $\mathbf{Sing}X \in [\text{CartSp}^{\text{op}}, \text{sSet}]$ for the simplicial presheaf given by

$$\mathbf{Sing}X : (U, [k]) \mapsto \text{Hom}_{\text{SmthMfd}}(U \times \Delta^k, X) .$$

Proposition 4.4.34. *The simplicial presheaf $\mathbf{Sing}X$ is a presentation of $\mathbf{\Pi}(X) \in \text{Smooth}\infty\text{Grpd}$.*

Proof. This reduces to the argument of prop. 4.3.37 after using the Steenrod approximation theorem [Wock09] to refine continuous paths to smooth paths \square

4.4.6 Cohomology

We discuss the intrinsic cohomology, 3.6.9, in $\text{Smooth}\infty\text{Grpd}$.

- 4.4.6.1 – Cohomology with constant coefficients;
- 4.4.6.2 – Refined Lie group cohomology.

4.4.6.1 Cohomology with constant coefficients

Proposition 4.4.35. *Let $A \in \infty\text{Grpd}$, write $\text{Disc}A \in \text{Smooth}\infty\text{Grpd}$ for the corresponding discrete smooth ∞ -groupoid. Let $X \in \text{SmoothMfd} \xrightarrow{i} \text{Smooth}\infty\text{Grpd}$ be a paracompact topological space regarded as a 0-truncated Euclidean-topological ∞ -groupoid.*

We have an isomorphism of cohomology sets

$$H_{\text{Top}}(X, A) \simeq H_{\text{Smooth}}(X, \text{Disc}A)$$

and in fact an equivalence of cocycle ∞ -groupoids

$$\text{Top}(X, |A|) \simeq \text{Smooth}\infty\text{Grpd}(X, \text{Disc}A).$$

More generally, for $X_{\bullet} \in \text{SmoothMfd}^{\Delta^{\text{op}}}$ presenting an object $X \in \text{Smooth}\infty\text{Grpd}$ we have

$$H_{\text{Smooth}}(X_{\bullet}, \text{Disc}A) \simeq H_{\text{Top}}(|X|, |A|).$$

Proof. This follows from the $(\text{II} \dashv \text{Disc})$ -adjunction and prop. 4.4.28. \square

4.4.6.2 Refined Lie group cohomology The cohomology of a Lie group G with coefficients in a Lie group A was historically originally defined in terms of cocycles given by smooth functions $G^{\times n} \rightarrow A$, by naive analogy with the situation discussed in 4.2.3.1. In the language of simplicial presheaves on CartSp these are morphisms of simplicial presheaves of the form $\mathbf{B}G_{\text{ch}} \rightarrow \mathbf{B}^n A$, with the notation as in 4.4.2. This is clearly not a good definition, in general, since while $\mathbf{B}^n A$ will be fibrant in $[\text{CartSp}^{\text{op}}, \text{sSet}]_{\text{proj.loc}}$, the object $\mathbf{B}G_{\text{ch}}$ in general fails to be cofibrant, hence the above naive definition in general misses cocycles.

A refined definition of Lie group cohomology was proposed in [Seg70] and later independently in [Bry00]. The following theorem asserts that the definitions given there do coincide with the intrinsic cohomology of the stack $\mathbf{B}G$ in the cohesive ∞ -topos $\text{Smooth}\infty\text{Grpd}$.

Theorem 4.4.36. *For $G \in \text{SmoothMfd} \hookrightarrow \text{Smooth}\infty\text{Grpd}$ a Lie group and A either*

1. *a discrete abelian group*
2. *the additive Lie group of real numbers \mathbb{R}*

the intrinsic cohomology of G in $\text{Smooth}\infty\text{Grpd}$ coincides with the refined Lie group cohomology of Segal [Seg70][Bry00]

$$H_{\text{Smooth}\infty\text{Grpd}}^n(\mathbf{B}G, A) \simeq H_{\text{Segal}}^n(G, A).$$

In particular we have in general

$$H_{\text{Smooth}\infty\text{Grpd}}^n(\mathbf{B}G, \mathbb{Z}) \simeq H_{\text{Top}}^n(BG, \mathbb{Z})$$

and for G compact and $n \geq 1$ also

$$H_{\text{Smooth}\infty\text{Grpd}}^n(\mathbf{B}G, U(1)) \simeq H_{\text{Top}}^{n+1}(BG, \mathbb{Z}).$$

Proof. The statement about constant coefficients is a special case of prop. 4.4.35. The statement about real coefficients is a special case of a more general statement in the context of synthetic differential ∞ -groupoids that will be proven as prop. 4.5.43. The last statement finally follows from this using that $H_{\text{Segal}}^n(G, \mathbb{R}) \simeq 0$ for positive n and G compact and using the fiber sequence, def. 3.6.138, induced by the short sequence $\mathbb{Z} \rightarrow \mathbb{R} \rightarrow \mathbb{R}/\mathbb{Z} \simeq U(1)$. \square

4.4.7 Principal bundles

We discuss principal ∞ -bundles, 3.6.10, realized in smooth ∞ -groupoids.

The following proposition asserts that the notion of smooth principal ∞ -bundle reproduces traditional notions of smooth bundles and smooth higher bundles.

Proposition 4.4.37. *For G a Lie group and $X \in \text{SmoothMfd}$, we have that*

$$\text{Smooth}\infty\text{Grpd}(X, \mathbf{B}G) \simeq \mathbf{B}\text{Bund}(X)$$

is equivalent to the groupoid of smooth principal G -bundles and smooth morphisms between these, as traditionally defined, where the equivalence is established by sending a morphism $g : X \rightarrow \mathbf{B}G$ in $\text{Smooth}\infty\text{Grpd}$ to the corresponding principal ∞ -bundle $P \rightarrow X$ according to prop. 3.6.156.

For $n \in \mathbb{N}$ and $G = \mathbf{B}^{n-1}U(1)$ the circle Lie n -group, def. 4.4.21, and $X \in \text{SmoothMfd}$, we have that

$$\text{Smooth}\infty\text{Grpd}(X, \mathbf{B}^n U(1)) \simeq U(1)(n-1)\text{BundGerbs}(X)$$

is equivalent to the n -groupoid of smooth $U(1)$ -bundle $(n-1)$ -gerbes.

Proof. Presenting $\text{Smooth}\infty\text{Grpd}$ by the local projective model structure $[\text{CartSp}^{\text{op}}, \text{sSet}]_{\text{proj,loc}}$ on simplicial presheaves over the site of Cartesian spaces, we have that $\mathbf{B}G$ is fibrant, by prop. 4.4.19, and that a cofibrant replacement for X is given by the Čech nerve $C(\{U_i\})$ of any differentiably good open cover $\{U_i \rightarrow X\}$. The cocycle ∞ -groupoid in question is then presented by the simplicial set $[\text{CartSp}^{\text{op}}, \text{sSet}](C(\{U_i\}), \mathbf{B}G)$ and this is readily seen to be the groupoid of Čech cocycles with coefficients in $\mathbf{B}G$ relative to the chosen cover.

This establishes that the two groupoids are equivalent. That the equivalence is indeed established by forming homotopy fibers of morphisms has been discussed in 1.2.5 (observing that by the discussion in 1.2.5.4 the ordinary pullback of the morphism $\mathbf{E}G \rightarrow \mathbf{B}G$ serves as a presentation for the homotopy pullback of $* \rightarrow \mathbf{B}G$). \square

This establishes the situation for smooth nonabelian cohomology in degree 1 and smooth abelian cohomology in arbitrary degree. We turn now to a discussion of smooth nonabelian cohomology “in degree 2”, the case where G is a Lie 2-group: *G -principal 2-bundles*.

When $G = \text{AUT}(H)$ the *automorphism 2-group* of a Lie group H (see below) these structures have the same classification as smooth H -1-gerbes, def. 3.6.261. To start with, note the general abstract notion of smooth 2-groups:

Definition 4.4.38. A *smooth 2-group* is a 1-truncated group object in $\mathbf{H} = \text{Sh}_{\infty}(\text{CartSp})$. These are equivalently given by their (canonically pointed) delooping 2-groupoids $\mathbf{B}G \in \mathbf{H}$, which are precisely, up to equivalence, the connected 2-truncated objects of \mathbf{H} .

For $X \in \mathbf{H}$ any object, $G2\text{Bund}_{\text{smooth}}(X) := \mathbf{H}(X, \mathbf{B}G)$ is the 2-groupoid of smooth G -principal 2-bundles on G .

We consider the presentation of smooth 2-groups by Lie crossed modules, def. 1.2.74, according to prop. 3.6.133. Write $[G_1 \xrightarrow{\delta} G_0]$ for the 2-group which is the groupoid

$$G_0 \times G_1 \begin{array}{c} \xrightarrow{p_1(-) \cdot \delta(p_2(-))} \\ \xrightarrow{p_1} \end{array} G_0$$

equipped with a strict group structure given by the semidirect product group structure on $G_0 \times G_1$ that is induced from the action ρ . The commutativity of the above two diagrams is precisely the condition for this to be consistent. Recall the examples of crossed modules, starting with example 1.2.79.

We discuss sufficient conditions for the delooping of a crossed module of presheaves to be fibrant in the projective model structure. Recall also the conditions from prop. 3.4.32.

Proposition 4.4.39. *Suppose that the smooth crossed module $(G_1 \rightarrow G_0)$ is such that the quotient $\pi_0 G = G_0/G_1$ is a smooth manifold and the projection $G_0 \rightarrow G_0/G_1$ is a submersion.*

Then $\mathbf{B}(G_1 \rightarrow G_0)$ is fibrant in $[\text{CartSp}^{\text{op}}, \text{sSet}]_{\text{proj,loc}}$.

Proof. We need to show that for $\{U_i \rightarrow \mathbb{R}^n\}$ a good open cover, the canonical descent morphism

$$B(C^\infty(\mathbb{R}^n, G_1) \rightarrow C^\infty(\mathbb{R}^n, G_0)) \rightarrow [\text{CartSp}^{\text{op}}, \text{sSet}](C(\{U_i\}), \mathbf{B}(G_1 \rightarrow G_0))$$

is a weak homotopy equivalence. The main point to show is that, since the Kan complex on the left is connected by construction, also the Kan complex on the right is.

To that end, notice that the category CartSp equipped with the open cover topology is a *Verdier site* in the sense of section 8 of [DHS04]. By the discussion there it follows that every hypercover over \mathbb{R}^n can be refined by a split hypercover, and these are cofibrant resolutions of \mathbb{R}^n in both the global and the local model structure $[\text{CartSp}^{\text{op}}, \text{sSet}]_{\text{proj,loc}}$. Since also $C(\{U_i\}) \rightarrow \mathbb{R}^n$ is a cofibrant resolution and since $\mathbf{B}G$ is clearly fibrant in the *global* structure, it follows from the existence of the global model structure that morphisms out of $C(\{U_i\})$ into $\mathbf{B}(G_1 \rightarrow G_0)$ capture all cocycles over any hypercover over \mathbb{R}^n , hence that

$$\pi_0[\text{CartSp}^{\text{op}}, \text{sSet}](C(\{U_i\}), \mathbf{B}(G_1 \rightarrow G_0)) \simeq H_{\text{smooth}}^1(\mathbb{R}^n, (G_1 \rightarrow G_0))$$

is the standard Čech cohomology of \mathbb{R}^n , defined as a colimit over refinements of covers of equivalence classes of Čech cocycles.

Now by prop. 4.1 of [NW11a] (which is the smooth refinement of the statement of [BSt] in the continuous context) we have that under our assumptions on $(G_1 \rightarrow G_0)$ there is a topological classifying space for this smooth Čech cohomology set. Since \mathbb{R}^n is topologically contractible, it follows that this is the singleton set and hence the above descent morphism is indeed an isomorphism on π_0 .

Next we can argue that it is also an isomorphism on π_1 , by reducing to the analogous local trivialization statement for ordinary principal bundles: a loop in $[\text{CartSp}^{\text{op}}, \text{sSet}](C(\{U_i\}), \mathbf{B}(G_1 \rightarrow G_0))$ on the trivial cocycle is readily seen to be a $G_0/(G_0 \times G_1)$ -principal groupoid bundle, over the action groupoid as indicated. The underlying $G_0 \times G_1$ -principal bundle has a trivialization on the contractible \mathbb{R}^n (by classical results or, in fact, as a special case of the previous argument), and so equivalence classes of such loops are given by G_0 -valued smooth functions on \mathbb{R}^n . The descent morphism exhibits an isomorphism on these classes.

Finally the equivalence classes of spheres on both sides are directly seen to be smooth $\ker(G_1 \rightarrow G_0)$ -valued functions on both sides, identified by the descent morphism. \square

Corollary 4.4.40. *For $X \in \text{SmoothMfd} \subset \mathbf{H}$ a paracompact smooth manifold, and $(G_1 \rightarrow G_0)$ as above, we have for any good open cover $\{U_i \rightarrow X\}$ that the 2-groupoid of smooth $(G_1 \rightarrow G_0)$ -principal 2-bundles is*

$$(G_1 \rightarrow G_0)\text{Bund}(X) := \mathbf{H}(X, \mathbf{B}(G_1)) \simeq [\text{CartSp}^{\text{op}}, \text{sSet}](C(\{U_i\}), \mathbf{B}(G_1 \rightarrow G_0))$$

and its set of connected components is naturally isomorphic to the nonabelian Čech cohomology

$$\pi_0 \mathbf{H}(X, \mathbf{B}(G_1 \rightarrow G_0)) \simeq H_{\text{smooth}}^1(X, (G_1 \rightarrow G_0)).$$

In particular, for $G = \text{AUT}(H)$, $\mathbf{B}G \in \mathbf{H}$ is the moduli 2-stack for smooth H -gerbes, def. 3.6.254.

Proposition 4.4.41. *For $A \rightarrow \hat{G} \rightarrow G$ a central extension of Lie groups such that $\hat{G} \rightarrow G$ is a locally trivial A -bundle, we have a long fiber sequence in $\text{Smooth}\infty\text{Grpd}$ of the form*

$$A \rightarrow \hat{G} \rightarrow G \rightarrow \mathbf{B}A \rightarrow \mathbf{B}\hat{G} \rightarrow \mathbf{B}G \xrightarrow{\mathbf{c}} \mathbf{B}^2 A,$$

where the morphism \mathbf{c} is presented by the span of simplicial presheaves

$$\begin{array}{ccc} \mathbf{B}(A \rightarrow \hat{G})_{\mathbf{c}} & \longrightarrow & \mathbf{B}(A \rightarrow 1)_{\mathbf{c}} \equiv \mathbf{B}^2 A_{\mathbf{c}} \\ \downarrow \simeq & & \\ \mathbf{B}G_{\text{ch}} & & \end{array}$$

coming from crossed complexes, def. 1.2.89, as indicated.

Proof. We need to show that

$$\begin{array}{ccc} \mathbf{B}\hat{G}_{\text{ch}} & \longrightarrow & * \\ \downarrow & & \downarrow \\ \mathbf{B}G_{\text{ch}} & \xrightarrow{c} & \mathbf{B}^2A \end{array}$$

is an ∞ -pullback. To that end, we notice that we have an equivalence

$$\mathbf{B}(A \rightarrow \hat{G})_c \xrightarrow{\simeq} \mathbf{B}G_{\text{ch}}$$

and that the morphism of simplicial presheaves $\mathbf{B}(A \xrightarrow{\text{id}} A)_c \rightarrow \mathbf{B}^2A_c$ is a fibration replacement of $* \rightarrow \mathbf{B}^2A_c$, both in $[\text{CartSp}^{\text{op}}, \text{sSet}]_{\text{proj}}$.

By prop. 2.3.13 it is therefore sufficient to observe the ordinary pullback diagram

$$\begin{array}{ccc} \mathbf{B}(1 \rightarrow A)_c & \longrightarrow & \mathbf{B}(A \xrightarrow{\text{id}} A)_c \\ \downarrow & & \downarrow \\ \mathbf{B}(A \rightarrow \hat{G}) & \longrightarrow & \mathbf{B}(A \rightarrow 1)_c \end{array}$$

□

4.4.8 Twisted cohomology and twisted bundles

We give an extensive discussion of twisted cohomology, 3.6.12, and the corresponding twisted principal ∞ -bundles, realized in $\text{Smooth}\infty\text{Grpd}$, below in 5.2. Most of the discussion there which does not involve differential refinement also goes through verbatim in $\text{ETop}\infty\text{Grpd}$, 4.3.

Notably in 5.2.2 we discuss as a simple consistency check that the general theory of twisted ∞ -bundles as sections of associated ∞ -bundles reproduces the ordinary notion of smooth sections of a vector bundle. Then in 5.2.3 we discuss that twisted vector bundles and hence twisted K-cocycles do arise as 2-sections of certain canonically associated 2-bundles to circle 2-bundles. This serves to show how the case of twisted cohomology that traditionally is at the focus the attention is reproduced. After that we discuss in 5.2 a wealth of further examples.

4.4.9 ∞ -Group representations

We discuss the intrinsic notion of ∞ -group representations, 3.6.13, realized in the context $\text{Smooth}\infty\text{Grpd}$.

We make precise the role of *action Lie groupoids*, introduced informally in 1.2.5.1.

Proposition 4.4.42. *Let X be a smooth manifold, and G a Lie group. Then the category of smooth G -actions on X in the traditional sense is equivalent to the category of G -actions on X in the cohesive ∞ -topos $\text{Smooth}\infty\text{Grpd}$, according to def. 3.6.149.*

Proof. For $\rho : X \times G \rightarrow X$ a given G -action, define the *action Lie groupoid*

$$X//G := (X \times G \begin{array}{c} \xrightarrow{\rho} \\ \xrightarrow{p_1} \end{array} X)$$

with the evident composition operation. This comes with the evident morphism of Lie groupoids

$$X//G \rightarrow *//G \simeq \mathbf{B}G,$$

with $\mathbf{B}G$ as in prop. 4.4.19. It is immediate that regarding this as a morphism in $[\mathbf{CartSp}^{\text{op}}, \mathbf{sSet}]_{\text{proj}}$ in the canonical way, this is a fibration. Therefore, by 2.3.13, the homotopy fiber of this morphism in $\mathbf{Smooth}\infty\mathbf{Grpds}$ is given by the ordinary fiber of this morphism in simplicial presheaves. This is manifestly X .

Accordingly this construction constitutes an embedding of the traditional G actions on X into the category $\mathbf{Rep}_G(X)$ from def. 3.6.149. By turning this argument around, one finds that this embedding is essentially surjective. \square

4.4.10 Associated bundles

We discuss aspects of the general notion of *associated ∞ -bundles*, 3.6.11, realized in the context of smooth cohesion.

We have been discussing the n -stacks $\mathbf{B}^n U(1)$ of *circle n -bundles* in 4.4.16, but without any substantial change in the theory we could also use the n -stacks $\mathbf{B}^n \mathbb{C}^\times$ which are the n -fold delooping in \mathbf{H} of the cohesive multiplicative group of non-zero complex numbers. Under geometric realization $|-| : \mathbf{H} \longrightarrow \infty\mathbf{Grpd}$ the canonical map $\mathbf{B}^n U(1) \rightarrow \mathbf{B}^n \mathbb{C}^\times$ becomes an equivalence. Nevertheless, some constructions are more naturally expressed in terms of $U(1)$ -principal n -bundles, while other are more naturally expressed in terms of \mathbb{C}^\times -principal n -bundles (bundle $(n-1)$ -gerbes). Notably the latter is naturally identified with the 2-stack $\mathbf{2Line}_{\mathbb{C}}$ of *complex line 2-bundles*.

To interpret this, we say that for R a ring (or more generally an E_∞ -ring), a *2-vector space* over R is, if it admits a *22-basis*, a category $A\mathbf{Mod}$ of modules over an R -algebra A (the algebra A is the given 2-basis), and that a *2-linear map* between 2-vector space is a functor $A\mathbf{Mod} \rightarrow B\mathbf{Mod}$ which is induced by tensoring with a B - A -bimodule. This identifies a 2-category $\mathbf{2Vect}_R$ of algebras, bimodules and bimodule homomorphisms which we call the 2-category of 2-vector spaces over R (appendix A of [Sc08], section 4.4. of [ScWa08], section 7 of [FHLT09]). This 2-category is naturally braided monoidal. Write then

$$\mathbf{2Line}_R \hookrightarrow \mathbf{2Vect}_R$$

for the full sub-2-category on those objects which are invertible under this tensor product: the *2-lines* over R . This is necessarily a 2-groupoid, the *Picard 2-groupoid* over R , and with the inherited monoidal structure it is a 3-group, the *Picard 3-group* of R . Its homotopy groups have a familiar algebraic interpretation:

- $\pi_0(\mathbf{2Line}_R)$ is the *Brauer group* of R ;
- $\pi_1(\mathbf{2Line}_R)$ is the ordinary *Picard group* of R (of ordinary R -lines);
- $\pi_2(\mathbf{2Line}_R) \simeq R^\times$ is the *group of units*.

If we take the base ring R to be the ring of suitable k -valued functions on some space X , then $\mathbf{2Vect}_R$ is the 2-category of k -2-vector spaces over that vary over X , hence of complex *2-vector bundles*. This construction is natural in R , hence in X , and it restricts to 2-lines and hence to *2-line bundles* over k . Hence there is a 2-stack $\mathbf{2Line}_k \in \mathbf{H}$ of 2-line bundles over k . If k here is algebraically closed, such as $k = \mathbb{C}$, then there is, up to equivalence, only a single 2-line, and only a single invertible bimodule, and hence we find that $\mathbf{2Line}_k \simeq \mathbf{B}^2 k^\times$. In particular we have an equivalence

$$\mathbf{2Line}_{\mathbb{C}} \simeq \mathbf{B}^2 \mathbb{C}^\times .$$

Therefore the 2-stack $\mathbf{2Line}_{\mathbb{C}}$ is of interest in particular in situations where this equivalence no longer holds. This is notably so in the context of supergeometric cohesion; this is discussed below in 4.6.3.

4.4.11 Manifolds

We discuss the realization of the general abstract notion of manifolds in a cohesive ∞ -topos in 3.9.2 realized in smooth cohesion.

With $\mathbb{A} := \mathbb{R} \in \text{SmthMfd} \hookrightarrow \text{Smooth}\infty\text{Grpd}$ the standard line object exhibiting the cohesion of $\text{Smooth}\infty\text{Grpd}$ according to prop. 4.3.33, def. 3.9.9 is equivalent to the traditional definition of smooth manifolds.

4.4.12 Flat connections and local systems

We discuss the intrinsic notion of flat ∞ -connections, 3.8.5, realized in $\text{Smooth}\infty\text{Grpd}$.

Proposition 4.4.43. *Let $X, A \in \text{Smooth}\infty\text{Grpd}$ be any two objects and write $|X| \in \text{Top}$ for the intrinsic geometric realization, def. 3.8.2. We have that the flat cohomology in $\text{Smooth}\infty\text{Grpd}$ of X with coefficients in A is equivalent to the ordinary cohomology in Top of $|X|$ with coefficients in underlying discrete object of A :*

$$H_{\text{Smooth,flat}}(X, A) \simeq H(|X|, |\Gamma A|).$$

Proof. By definition we have

$$H_{\text{flat}}(X, A) \simeq H(\Pi X, A) \simeq H(\text{Disc}\Pi X, A).$$

Using the $(\text{Disc}) \dashv \Gamma$ -adjunction this is

$$\cdots \pi_0 \infty \text{Grpd}(\Pi X, \Gamma A).$$

Finally applying the equivalence $|\cdot| : \infty \text{Grpd} \rightarrow \text{Top}$ this is

$$\cdots \simeq H(|\Pi X|, |\Gamma A|).$$

The claim hence follows as in prop. 4.4.35. □

Let G be a Lie group regarded as a 0-truncated ∞ -group in $\text{Smooth}\infty\text{Grpd}$. Write \mathfrak{g} for its Lie algebra. Write $\mathbf{B}G \in \text{Smooth}\infty\text{Grpd}$ for its delooping. Recall the fibrant presentation $\mathbf{B}G_{\text{ch}} \in [\text{CartSp}_{\text{smooth}}^{\text{op}}, \text{sSet}]_{\text{proj,loc}}$ from prop. 4.4.19.

Proposition 4.4.44. *The object $\mathfrak{b}\mathbf{B}G \in \text{Smooth}\infty\text{Grpd}$ has a fibrant presentation $\mathfrak{b}\mathbf{B}G_{\text{ch}} \in [\text{CartSp}^{\text{op}}, \text{sSet}]_{\text{proj,loc}}$ given by the groupoid of Lie-algebra valued forms*

$$\mathfrak{b}\mathbf{B}G_{\text{ch}} = N \left(C^\infty(-, G) \times \Omega_{\text{flat}}^1(-, \mathfrak{g}) \begin{array}{c} \xrightarrow{\text{Ad}_{p_1}(p_2) + p_1^{-1} dp_1} \\ \xrightarrow{p_2} \end{array} \Omega_{\text{flat}}^1(-, \mathfrak{g}) \right)$$

and this is such that the canonical morphism $\mathfrak{b}\mathbf{B}G \rightarrow \mathbf{B}G$ is presented by the canonical morphism of simplicial presheaves $\mathfrak{b}\mathbf{B}G_{\text{ch}} \rightarrow \mathbf{B}G_{\text{ch}}$ which is a fibration in $[\text{CartSp}_{\text{smooth}}^{\text{op}}, \text{sSet}]_{\text{proj}}$.

Remark 4.4.45. This means that a U -parameterized family of objects of $\mathfrak{b}\mathbf{B}G_{\text{ch}}$ is given by a Lie-algebra valued 1-form $A \in \Omega^1(U) \otimes \mathfrak{g}$ whose curvature 2-form $F_A = d_{\text{dR}}A + [A, \wedge A] = 0$ vanishes, and a U -parameterized family of morphisms $g : A \rightarrow A'$ is given by a smooth function $g \in C^\infty(U, G)$ such that $A' = \text{Ad}_g A + g^{-1} dg$, where $\text{Ad}_g A = g^{-1} A g$ is the adjoint action of G on its Lie algebra, and where $g^{-1} dg := g^* \theta$ is the pullback of the Maurer-Cartan form on G along g .

Proof. By the proof of prop. 3.4.18 we have that $\mathfrak{b}\mathbf{B}G$ is presented by the simplicial presheaf that is constant on the nerve of the one-object groupoid

$$G_{\text{disc}} \rightrightarrows *$$

for the discrete group underlying the Lie group G . The canonical morphism of that into \mathbf{BG}_{ch} is however not a fibration. We claim that the canonical inclusion $N(G_{\text{disc}} \rightrightarrows *) \rightarrow \mathfrak{b}\mathbf{BG}_c$ factors the inclusion into \mathbf{BG}_{ch} by a weak equivalence followed by a global fibration.

To see the weak equivalence, notice that it is objectwise an equivalence of groupoids: it is essentially surjective since every flat \mathfrak{g} -valued 1-form on the contractible \mathbb{R}^n is of the form gdg^{-1} for some function $g : \mathbb{R}^n \rightarrow G$ (let $g(x) = P \exp(\int_0^x) A$ be the parallel transport of A along any path from the origin to x). Since the gauge transformation automorphism of the trivial \mathfrak{g} -valued 1-form are precisely given by the constant G -valued functions, this is also objectwise a full and faithful functor. Similarly one sees that the map $\mathfrak{b}\mathbf{BG}_{\text{ch}} \rightarrow \mathbf{BG}$ is a fibration.

Finally we need to show that $\mathfrak{b}\mathbf{BG}_{\text{ch}}$ is fibrant in $[\text{CartSp}_{\text{smooth}}^{\text{op}}, \text{sSet}]_{\text{proj,loc}}$. This is implied by theorem 3.4.25. More explicitly, this can be seen by observing that this sheaf is the coefficient object that in Čech cohomology computes G -principal bundles with flat connection and then reasoning as above: every G -principal bundle with flat connection on a Cartesian space is equivalent to a trivial G -principal bundle whose connection is given by a globally defined \mathfrak{g} -valued 1-form. Morphisms between these are precisely G -valued functions that act on the 1-forms by gauge transformations as in the groupoid of Lie-algebra valued forms. \square

Let now $\mathbf{B}^n U(1)$ be the circle $(n+1)$ -Lie group, def. 4.4.21. Recall the notation and model category presentations as discussed there.

Proposition 4.4.46. *For $n \geq 1$ a fibration presentation in $[\text{CartSp}^{\text{op}}, \text{sSet}]_{\text{proj}}$ of the canonical morphism $\mathfrak{b}\mathbf{B}^n U(1) \rightarrow \mathbf{B}^n U(1)$ in $\text{Smooth}\infty\text{Grpd}$ is given by the image under $\Xi : [\text{CartSp}^{\text{op}}, \text{Ch}^+] \rightarrow [\text{CartSp}^{\text{op}}, \text{sSet}]$ of the morphism of chain complexes*

$$\begin{array}{ccccccc} C^\infty(-, U(1)) & \xrightarrow{d_{\text{dR}}} & \Omega^1(-) & \xrightarrow{d_{\text{dR}}} & \cdots & \xrightarrow{d_{\text{dR}}} & \Omega_{\text{cl}}^n(-) , \\ \downarrow & & \downarrow & & & & \downarrow \\ C^\infty(-, U(1)) & \longrightarrow & 0 & \longrightarrow & \cdots & \longrightarrow & 0 \end{array}$$

where at the top we have the flat Deligne complex.

Proof. It is clear that the morphism of chain complexes is an objectwise surjection and hence maps to a projective fibration under Ξ . It remains to observe that the flat Deligne complex is a presentation of $\mathfrak{b}\mathbf{B}^n U(1)$:

By the proof of prop. 3.4.18 we have that $\mathfrak{b} = \text{Disc} \circ \Gamma$ is presented in the model category on fibrant objects by first evaluating on the point and then extending back to a constant simplicial presheaf. Since $\Xi U(1)[n]$ is indeed globally fibrant, a fibrant presentation of $\mathfrak{b}\mathbf{B}^n U(1)$ is given by the *constant* presheaf $U(1)_{\text{const}}[n] : U \mapsto \Xi(U(1)[n])$.

The inclusion $U(1)_{\text{const}}[n] \rightarrow U(1)[n]$ is not yet a fibration. But by a basic fact of abelian sheaf cohomology – using the Poincaré lemma – we have a global weak equivalence $U(1)_{\text{const}}[n] \xrightarrow{\sim} [C^\infty(-, U(1)) \xrightarrow{d_{\text{dR}}} \cdots \xrightarrow{d_{\text{dR}}} \Omega_{\text{cl}}^n(-)]$ that factors this inclusion by the above fibration. This completes the proof.

For emphasis, we repeat this argument in more detail. The factorization of $U(1)_{\text{const}}[n] \rightarrow U(1)[n]$ into a weak equivalence followed by a fibration that we are looking at is over each object $\mathbb{R}^q \in \text{CartSp}$ in the site given by the morphisms of chain complexes whose components are show on the following diagram.

$$\begin{array}{ccccccc} U(1) & \longrightarrow & 0 & \longrightarrow & 0 & \longrightarrow & \cdots & \longrightarrow & 0 \\ \downarrow & & \downarrow & & \downarrow & & & & \downarrow \\ C^\infty(\mathbb{R}^q, U(1)) & \xrightarrow{d_{\text{dR}} \log} & \Omega^1(\mathbb{R}^q) & \xrightarrow{d_{\text{dR}}} & \Omega^2(\mathbb{R}^q) & \xrightarrow{d_{\text{dR}}} & \cdots & \xrightarrow{d_{\text{dR}}} & \Omega_{\text{cl}}^n(\mathbb{R}^q) \\ \downarrow \text{id} & & \downarrow & & \downarrow & & & & \downarrow \\ C^\infty(\mathbb{R}^q, U(1)) & \longrightarrow & 0 & \longrightarrow & 0 & \longrightarrow & \cdots & \longrightarrow & 0 \end{array}$$

It is clear that this commutes. It is also clear that the lower vertical morphisms are all surjections, so the lower row exhibits a fibration of chain complexes. In order for the top row to exhibit a weak equivalence of chain complexes – a quasi-isomorphism – we need it to induce an isomorphism on all chain homology groups.

The chain homology of the top complex is evidently concentrated in degree n , where it is $U(1)$, as a discrete group.

The chain homology of the middle complex in degree n is the kernel of the differential $d_{\mathrm{dR}\log} : C^\infty(\mathbb{R}^q, U(1)) \rightarrow \Omega^1(\mathbb{R}^q)$. This kernel manifestly consists of the constant $U(1)$ -valued functions. Since \mathbb{R}^q is connected, these are naturally identified with the group $U(1)$ itself. This identification is indeed what the top left vertical morphism exhibits.

The chain homology of the middle complex in degree $0 \leq k < n$ is the de Rham cohomology $H_{\mathrm{dR}}^{n-k}(\mathbb{R}^q)$. But this vanishes, since \mathbb{R}^q is smoothly contractible (the Poincaré lemma).

Therefore the homology groups of the top and of the middle chain complex coincide. And by this discussion, the top vertical morphisms induce isomorphisms on these homology groups. \square

We discuss presentations of $\mathfrak{b}\mathbf{B}G$ for G more generally the Lie integration of an L_∞ -algebra \mathfrak{g} further below in 4.4.14.2.

4.4.13 de Rham cohomology

We discuss intrinsic notion of de Rham cohomology in a cohesive ∞ -topos, 3.9.3, realized in the context $\mathrm{Smooth}\infty\mathrm{Grpd}$. Here it reproduces the traditional notion of de Rham cohomology with abelian and non-abelian group coefficients, as well as its equivariant and simplicial refinements.

Let G be a Lie group. Write \mathfrak{g} for its Lie algebra.

Proposition 4.4.47. *The object $\mathfrak{b}_{\mathrm{dR}}\mathbf{B}G \in \mathrm{Smooth}\infty\mathrm{Grpd}$ has a fibrant presentation in $[\mathrm{CartSp}_{\mathrm{smooth}}^{\mathrm{op}}, \mathrm{sSet}]_{\mathrm{proj}, \mathrm{loc}}$ by the sheaf $\mathfrak{b}\mathbf{B}G_{\mathrm{ch}} := \Omega_{\mathrm{flat}}^1(-, \mathfrak{g})$ of flat Lie algebra-valued forms*

$$\mathfrak{b}\mathbf{B}G_{\mathrm{ch}} : U \mapsto \Omega_{\mathrm{flat}}^1(U, \mathfrak{g}).$$

Proof. By prop. 4.4.44 we have a fibration $\mathfrak{b}\mathbf{B}G_{\mathrm{ch}} \rightarrow \mathbf{B}G_{\mathrm{ch}}$ in $[\mathrm{CartSp}_{\mathrm{smooth}}^{\mathrm{op}}, \mathrm{sSet}]_{\mathrm{proj}}$ given by the morphism of sheaves of groupoids

$$\begin{array}{ccc} C^\infty(-, G) & \xrightarrow{(-)^*\theta} & \Omega_{\mathrm{flat}}^1(-, \mathfrak{g}) \\ \downarrow \mathrm{id} & & \downarrow \\ C^\infty(-, G) & \longrightarrow & 0 \end{array},$$

which models the canonical inclusion $\mathfrak{b}\mathbf{B}G \rightarrow \mathbf{B}G$. Therefore by prop. 2.3.8 we obtain a presentation for the defining ∞ -pullback

$$\mathfrak{b}_{\mathrm{dR}}\mathbf{B}G := * \times_{\mathbf{B}G} \mathfrak{b}\mathbf{B}G$$

in $\mathrm{Smooth}\infty\mathrm{Grpd}$ by the ordinary pullback

$$\mathfrak{b}_{\mathrm{dR}}\mathbf{B}G_{\mathrm{ch}} \simeq * \times_{\mathbf{B}G_{\mathrm{ch}}} \mathfrak{b}\mathbf{B}G_{\mathrm{ch}}$$

in $[\mathrm{CartSp}^{\mathrm{op}}, \mathrm{sSet}]_{\mathrm{proj}}$. This is manifestly equal to $\Omega_{\mathrm{flat}}^1(-, \mathfrak{g})$. This is fibrant in $[\mathrm{CartSp}^{\mathrm{op}}, \mathrm{sSet}]_{\mathrm{proj}, \mathrm{loc}}$ because it is a sheaf. \square

Remark 4.4.48. Another equivalent way to compute the homotopy fiber in prop. 4.4.47 is to produce the fibration resolution specifically by the factorization lemma, prop. 2.3.9. This yields for the de Rham coefficients of the Lie group G the presentation

$$\mathfrak{b}_{\mathrm{dR}}\mathbf{B}G \simeq G / (G_{\mathrm{disc}}),$$

where on the right we have the quotient (of sheaves, hence in $\text{Smooth}\infty\text{Grpd}$) of the Lie group G (the sheaf $C^\infty(-, G)$) by the underlying *geometrically discrete* group (the sheaf constant on the underlying set of G). In other words, over a $U \in \text{CartSp}$ the value of $G/(G_{\text{disc}})$ is the set of equivalence classes of smooth functions $g : U \rightarrow G$, where two are regarded as equivalent if they differ by multiplication with a *constant* such function.

By the general theory this sheaf must be equivalent, hence isomorphic, to the one of prop. 4.4.47. Indeed, G_{disc} is the kernel of the map $(-)^*\theta : C^\infty(-, G) \longrightarrow \Omega_{\text{flat}}^1(-, \mathfrak{g})$ which sends $g : U \rightarrow G$ to the pullback of the Maurer-Cartan form along g , often written $g^{-1}d_{\text{dR}}g$. Moreover this map is surjective, since for $A \in \Omega_{\text{flat}}^1(U, \mathfrak{g})$ any flat \mathfrak{g} -valued form the function $P \exp(\int_{x_0}^{(-)} A) : U \rightarrow G$ that sends a point $x \in U$ to the parallel transport of A along any path from any fixed basepoint $x_0 \in U$ is a preimage. Hence we have the image factorization

$$(-)^*\theta : G \twoheadrightarrow G/(G_{\text{disc}}) \xrightarrow{\simeq} \Omega_{\text{flat}}^1(-, \mathfrak{g}) .$$

In words this says that a flat differential Lie-algebra valued form on a Cartesian space \mathbb{R}^k is equivalently a smooth function from that space to G “without remembering the origin of this function”. What is noteworthy about this is that this second, equivalent, description, no longer refers to *differentials*.

Indeed, this second description of the de Rham coefficient object of a group object is valid for any site, in particular for instance for the Euclidean-topological cohesion of 4.3.

For $n \in \mathbb{N}$, let now $\mathbf{B}^n U(1)$ be the circle Lie $(n+1)$ -group of def. 4.4.21. Recall the notation and model category presentations from the discussion there.

Proposition 4.4.49. *A fibrant representative in $[\text{CartSp}^{\text{op}}, \text{sSet}]_{\text{proj,loc}}$ of the de Rham coefficient object $\mathfrak{b}_{\text{dR}}\mathbf{B}^n U(1)$ from def. 3.9.12 is given by the truncated ordinary de Rham complex of smooth differential forms*

$$\mathfrak{b}_{\text{dR}}\mathbf{B}^n U(1)_{\text{chn}} := \Xi[\Omega^1(-) \xrightarrow{d_{\text{dR}}} \Omega^2(-) \xrightarrow{d_{\text{dR}}} \dots \rightarrow \Omega^{n-1}(-) \xrightarrow{d_{\text{dR}}} \Omega_{\text{cl}}^n(-)] .$$

Proof. By definition and using prop. 2.3.13 the object $\mathfrak{b}_{\text{dR}}\mathbf{B}^n U(1)$ is given by the homotopy pullback in $[\text{CartSp}^{\text{op}}, \text{Ch}_{\bullet \geq 0}]_{\text{proj}}$ of the inclusion $U(1)_{\text{const}}[n] \rightarrow U(1)[n]$ along the point inclusion $* \rightarrow U(1)[n]$. We may compute this as the ordinary pullback after passing to a resolution of this inclusion by a fibration. By prop. 4.4.46 such a fibration replacement is given by the map from the flat Deligne complex. Using this we find the ordinary pullback diagram

$$\begin{array}{ccc} \Xi[0 \rightarrow \Omega^1(-) \rightarrow \dots \rightarrow \Omega_{\text{cl}}^n(-)] & \longrightarrow & \Xi[C^\infty(-, U(1)) \rightarrow \Omega^1(-) \rightarrow \dots \rightarrow \Omega_{\text{cl}}^n(-)] \\ \downarrow & & \downarrow \\ \Xi[0 \rightarrow 0 \rightarrow \dots \rightarrow 0] & \longrightarrow & \Xi[C^\infty(-, U(1)) \rightarrow 0 \rightarrow \dots \rightarrow 0] \end{array}$$

□

Proposition 4.4.50. *Let X be a smooth manifold regarded under the embedding $\text{SmoothMfd} \hookrightarrow \text{Smooth}\infty\text{Grpd}$. Write $H_{\text{dR}}^n(X)$ for the ordinary de Rham cohomology of X .*

For $n \in \mathbb{N}$ we have isomorphisms

$$\pi_0 \text{Smooth}\infty\text{Grpd}(X, \mathfrak{b}_{\text{dR}}\mathbf{B}^n U(1)) \simeq \begin{cases} H_{\text{dR}}^n(X) & |n \geq 2 \\ \Omega_{\text{cl}}^1(X) & |n = 1 \\ 0 & |n = 0 \end{cases}$$

Proof. Let $\{U_i \rightarrow X\}$ be a differentiably good open cover. The Čech nerve $C(\{U_i\}) \rightarrow X$ is a cofibrant resolution of X in $[\text{CartSp}^{\text{op}}, \text{sSet}]_{\text{proj,loc}}$. Therefore we have for all $n \in \mathbb{N}$

$$\text{Smooth}\infty\text{Grpd}(X, \mathfrak{b}_{\text{dR}}\mathbf{B}^n U(1)) \simeq [\text{CartSp}^{\text{op}}, \text{sSet}](C(\{U_i\}), \Xi[\Omega^1(-) \xrightarrow{d_{\text{dR}}} \cdots \rightarrow \Omega_{\text{cl}}^n(-)]).$$

The right hand is the ∞ -groupoid of cocycles in the Čech hypercohomology of the truncated complex of sheaves of differential forms. A cocycle is given by a collection

$$(C_i, B_{ij}, A_{ijk}, \cdots, Z_{i_1, \dots, i_n})$$

of differential forms, with $C_i \in \Omega_{\text{cl}}^n(U_i)$, $B_{ij} \in \Omega^{n-1}(U_i \cap U_j)$, etc., such that this collection is annihilated by the total differential $D = d_{\text{dR}} \pm \delta$, where d_{dR} is the de Rham differential and δ the alternating sum of the pullbacks along the face maps of the Čech nerve.

It is a standard result of abelian sheaf cohomology that such cocycles represent classes in de Rham cohomology of $n \geq 2$. For $n = 1$ and $n = 0$ our truncated de Rham complex degenerates to $\mathfrak{b}_{\text{dR}}\mathbf{B}U(1)_{\text{chn}} = \Xi[\Omega_{\text{cl}}^1(-)]$ and $\mathfrak{b}_{\text{dR}}U(1)_{\text{chn}} = \Xi[0]$, respectively, which obviously has the cohomology as claimed above. \square

Remark 4.4.51. Recall from the discussion in 3.9.3 that the failure of the intrinsic de Rham cohomology of $\text{Smooth}\infty$ to coincide with traditional de Rham cohomology in degree 0 and 1 is due to the fact that the intrinsic de Rham cohomology in degree n is the home for curvature classes of circle $(n - 1)$ -bundles. For $n = 1$ these curvatures are not to be taken modulo exact forms. And for $n = 0$ they vanish.

Definition 4.4.52. For $n \in \mathbb{N}$, write $\Omega_{\text{cl}}^n \in \text{Sh}(\text{CartSp}) \hookrightarrow \text{Smooth}\infty\text{Grpd}$ for the ordinary sheaf of smooth closed differential n -forms. By prop. 4.4.49 this has a canonical morphism

$$\Omega_{\text{cl}}^n \rightarrow \mathfrak{b}_{\text{dR}}\mathbf{B}^n U(1)$$

into the de Rham coefficient object for $\mathbf{B}^{n-1}U(1)$, given in the presentation of the latter as a simplicial presheaf according to prop. 4.4.49 by the inclusion of the simplicial presheaf that is simplicially constant on the degree-0 component.

Proposition 4.4.53. *The morphisms of def. 4.4.52 are differential form objects in the sense of def. 3.9.20 with respect to the standard line object \mathbb{R} .*

Proof. By the discussion in 4.4.11 the \mathbb{R}^1 -manifolds are precisely the objects in the inclusion $\text{SmthMfd} \hookrightarrow \text{Sh}_{\infty}(\text{SmthMfd}) \simeq \text{Smooth}\infty\text{Grpd}$. This means by def. 3.9.20 that we need to check that for each smooth manifold Σ the morphism

$$[\Sigma, \Omega_{\text{cl}}^n] \rightarrow [\Sigma, \mathfrak{b}_{\text{dR}}\mathbf{B}^n U(1)]$$

is an effective epimorphism. By prop. 2.3.6 this is equivalent to the 0-truncation of the morphism being an epimorphism in the sheaf topos $\text{Sh}(\text{CartSp})$. By the characterization of internal homs in turn, for this it is sufficient that for each $U \in \text{CartSp}$ the function $\Omega_{\text{cl}}^n(\Sigma \times U) \rightarrow \pi_0 \mathbf{H}(\Sigma \times U, \mathfrak{b}_{\text{dR}}\mathbf{B}^n U(1))$ is a surjection. This is the case by prop. 4.4.50. \square

We discuss the equivariant version of smooth de Rham cohomology.

Proposition 4.4.54. *Let X be a smooth manifold equipped with a smooth action by a Lie group G . Write $X//G$ for the corresponding action Lie groupoid, prop. 5.2.1. Then for $n \geq 2$ we have an isomorphism*

$$\pi_0 \text{Smooth}\infty\text{Grpd}(X//G, \mathfrak{b}_{\text{dR}}\mathbf{B}^n \mathbb{R}) \simeq H_{\text{dR}, G}^n(X),$$

where on the right we have ordinary G -equivariant de Rham cohomology of X .

4.4.14 Exponentiated ∞ -Lie algebras

We discuss the intrinsic notion of exponentiated ∞ -Lie algebras, 3.9.4, realized in $\text{Smooth}\infty\text{Grpd}$.

Recall the characterization of L_∞ -algebras, def. 1.2.143, by dual dg-algebras, prop. 1.2.145 – their *Chevalley-Eilenberg algebras*–, and the characterization of the category $L_\infty\text{Alg}$ as the full subcategory

$$L_\infty \xrightarrow{\text{CE}} \text{dgAlg}^{\text{op}} .$$

We describe now a presentation of the exponentiation of an L_∞ algebra to a smooth ∞ -group. The following somewhat technical definition serves to control the smooth structure on these exponentiated objects.

Definition 4.4.55. For $k \in \mathbb{N}$ regard the k -simplex Δ^k as a smooth manifold with corners in the standard way. We think of this embedded into the Cartesian space \mathbb{R}^k in the standard way with maximal rotation symmetry about the center of the simplex, and equip Δ^k with the metric space structure induced this way.

A smooth differential form ω on Δ^k we say has *sitting instants* along the boundary if, for every ($r < k$)-face F of Δ^k there is an open neighbourhood U_F of F in Δ^k such that ω restricted to U is constant in the directions perpendicular to the r -face on its value restricted to that face.

More generally, for any $U \in \text{CartSp}$ a smooth differential form ω on $U \times \Delta^k$ is said to have sitting instants if there is $0 < \epsilon \in \mathbb{R}$ such that for all points $u : * \rightarrow U$ the pullback along $(u, \text{Id}) : \Delta^k \rightarrow U \times \Delta^k$ is a form with sitting instants on ϵ -neighbourhoods of faces.

Smooth forms with sitting instants form a sub-dg-algebra of all smooth forms. We write $\Omega_{\text{si}}^\bullet(U \times \Delta^k)$ for this sub-dg-algebra.

We write $\Omega_{\text{si,vert}}^\bullet(U \times \Delta^k)$ for the further sub-dg-algebra of vertical differential forms with respect to the projection $p : U \times \Delta^k \rightarrow U$, hence the coequalizer

$$\Omega^{\bullet \geq 1}(U) \begin{array}{c} \xrightarrow{p^*} \\ \xrightarrow{0} \end{array} \Omega_{\text{si}}^\bullet(U \times \Delta^k) \longrightarrow \Omega_{\text{si,vert}}^\bullet(U \times \Delta^k) .$$

Definition 4.4.56. For $\mathfrak{g} \in L_\infty$ write $\exp(\mathfrak{g}) \in [\text{CartSp}_{\text{smooth}}^{\text{op}}, \text{sSet}]$ for the simplicial presheaf defined over $U \in \text{CartSp}$ and $n \in \mathbb{N}$ by

$$\exp(\mathfrak{g}) : (U, [n]) \mapsto \text{Hom}_{\text{dgAlg}}(\Omega_{\text{si,vert}}^\bullet(U \times \Delta^n), \text{CE}(\mathfrak{g}))$$

with the evident structure maps given by pullback of differential forms.

This definition of the ∞ -groupoid associated to an L_∞ -algebra realized in the smooth context appears in [FSS10] and in similar form in [Roy10] as the evident generalization of the definition in Banach spaces in [Hen08] and for discrete ∞ -groupoids in [Ge09], which in turn goes back to [Hin97].

Proposition 4.4.57. *The objects $\exp(\mathfrak{g}) \in [\text{CartSp}_{\text{smooth}}^{\text{op}}, \text{sSet}]$ are*

1. *connected;*
2. *Kan complexes over each $U \in \text{CartSp}$.*

Proof. That $\exp(\mathfrak{g})_0 = *$ follows from degree-counting: $\Omega_{\text{si,vert}}^\bullet(U \times \Delta^0) = C^\infty(U)$ is entirely in degree 0 and $\text{CE}(\mathfrak{g})$ is in degree 0 the ground field \mathbb{R} .

To see that $\exp(\mathfrak{g})$ has all horn-fillers over each $U \in \text{CartSp}$ observe that the standard continuous horn retracts $f : \Delta^k \rightarrow \Lambda_i^k$ are smooth away from the preimages of the ($r < k$)-faces of $\Lambda[k]^i$.

For $\omega \in \Omega_{\text{si,vert}}^\bullet(U \times \Lambda[k]^i)$ a differential form with sitting instants on ϵ -neighbourhoods, let therefore $K \subset \partial\Delta^k$ be the set of points of distance $\leq \epsilon$ from any subspace. Then we have a smooth function

$$f : \Delta^k \setminus K \rightarrow \Lambda_i^k \setminus K .$$

The pullback $f^*\omega \in \Omega^\bullet(\Delta^k \setminus K)$ may be extended constantly back to a form with sitting instants on all of Δ^k . The resulting assignment

$$(\mathrm{CE}(\mathfrak{g}) \xrightarrow{A} \Omega_{\mathrm{si},\mathrm{vert}}^\bullet(U \times \Lambda_i^k)) \mapsto (\mathrm{CE}(\mathfrak{g}) \xrightarrow{A} \Omega_{\mathrm{si},\mathrm{vert}}^\bullet(U \times \Lambda_i^k) \xrightarrow{f^*} \Omega_{\mathrm{si},\mathrm{vert}}^\bullet(U \times \Delta^n))$$

provides fillers for all horns over all $U \in \mathrm{CartSp}$. □

Definition 4.4.58. We say that the loop space object $\Omega \exp(\mathfrak{g})$ is the *smooth* ∞ -group exponentiating \mathfrak{g} .

Proposition 4.4.59. *The objects $\exp(\mathfrak{g}) \in \mathrm{Smooth}\infty\mathrm{Grpd}$ are geometrically contractible:*

$$\Pi \exp(\mathfrak{g}) \simeq *.$$

Proof. Observe that every simplicial presheaf X is the homotopy colimit over its component presheaves $X_n \in [\mathrm{CartSp}_{\mathrm{smooth}}^{\mathrm{op}}, \mathrm{Set}] \hookrightarrow [\mathrm{CartSp}_{\mathrm{smooth}}^{\mathrm{op}}, \mathrm{sSet}]$

$$X \simeq \mathbb{L}\lim_{\rightarrow n} X_n.$$

(Use for instance the injective model structure for which X_\bullet is cofibrant in the Reedy model structure $[\Delta^{\mathrm{op}}, [\mathrm{CartSp}_{\mathrm{smooth}}^{\mathrm{op}}, \mathrm{sSet}]_{\mathrm{inj},\mathrm{loc}}]_{\mathrm{Reedy}}$). Therefore it is sufficient to show that in each degree n the 0-truncated object $\exp(\mathfrak{g})_n$ is geometrically contractible.

To exhibit a geometric contraction, def. 3.8.4, choose for each $n \in \mathbb{N}$, a smooth retraction

$$\eta_n : \Delta^n \times [0, 1] \rightarrow \Delta^n$$

of the n -simplex: a smooth map such that $\eta_n(-, 1) = \mathrm{Id}$ and $\eta_n(-, 0)$ factors through the point. We claim that this induces a diagram of presheaves

$$\begin{array}{ccc} \exp(\mathfrak{g})_n & & \\ \downarrow (\mathrm{id}, 1) & \searrow \mathrm{id} & \\ \exp(\mathfrak{g})_n \times [0, 1] & \xrightarrow{\eta_n^*} & \exp(\mathfrak{g})_n \\ \uparrow (\mathrm{id}, 0) & & \uparrow \\ \exp(\mathfrak{g})_n & \longrightarrow & * \end{array},$$

where over $U \in \mathrm{CartSp}$ the middle morphism is given by

$$\eta_n^* : (\alpha, f) \mapsto (f, \eta_n)^* \alpha,$$

where

- $\alpha : \mathrm{CE}(\mathfrak{g}) \rightarrow \Omega_{\mathrm{si},\mathrm{vert}}^\bullet(U \times \Delta^n)$ is an element of the set $\exp(\mathfrak{g})_n(U)$,
- f is an element of $[0, 1](U)$;
- (f, η_n) is the composite morphism

$$U \times \Delta^n \xrightarrow{(\mathrm{id}, f) \times \mathrm{id}} U \times [0, 1] \times \Delta^n \xrightarrow{(\mathrm{id}, \eta_n)} U \times \Delta^n$$

- $(f, \eta)^* \alpha$ is the postcomposition of α with the image of (f, η_n) under $\Omega_{\mathrm{vert}}^\bullet(-)$.

Here the last item is well defined given the coequalizer definition of $\Omega_{\text{vert}}^\bullet$ because (f, η_n) is a morphism of bundles over U

$$\begin{array}{ccccc} U \times \Delta^n & \xrightarrow{(id, f) \times id} & U \times [0, 1] \times \Delta^n & \xrightarrow{id \times \eta_n} & U \times \Delta^n \\ \downarrow & & \downarrow & & \downarrow \\ U & \xrightarrow{id} & U & \xrightarrow{id} & U \end{array}$$

Similarly, for $h : K \rightarrow U$ any morphism in $\text{CartSp}_{\text{smooth}}$ the naturality condition for a morphism of presheaves follows from the fact that the composites of bundle morphisms

$$\begin{array}{ccccccc} K \times \Delta^n & \xrightarrow{h \times id} & U \times \Delta^n & \xrightarrow{(id, f) \times id} & U \times [0, 1] \times \Delta^n & \xrightarrow{(id, \eta_n)} & U \times \Delta^n \\ \downarrow & & \downarrow & & \downarrow & & \downarrow \\ K & \xrightarrow{h} & U & \xrightarrow{id} & U & \xrightarrow{id} & U \end{array}$$

and

$$\begin{array}{ccccccc} K \times \Delta^n & \xrightarrow{(id, f \circ h) \times id} & K \times [0, 1] \times \Delta^n & \xrightarrow{id \times \eta_n} & K \times \Delta^n & \xrightarrow{h \times id} & U \times \Delta^n \\ \downarrow & & \downarrow & & \downarrow & & \downarrow \\ K & \xrightarrow{id} & K & \xrightarrow{id} & K & \xrightarrow{h} & U \end{array}$$

coincide.

Moreover, notice that the lower morphism in our diagram of presheaves indeed factors through the point as indicated, because for an L_∞ -algebra \mathfrak{g} we have that the Chevalley-Eilenberg algebra $\text{CE}(\mathfrak{g})$ is in degree 0 the ground field algebra \mathbb{R} , so that there is a unique morphism $\text{CE}(\mathfrak{g}) \rightarrow \Omega_{\text{vert}}^\bullet(U \times \Delta^0) \simeq C^\infty(U)$ in dgAlg .

Finally, since $[0, 1]$ is a contractible paracompact manifold, we have that $\Pi([0, 1]) \simeq *$ by prop. 4.3.29. Therefore the above diagram of presheaves presents a geometric homotopy in $\text{Smooth}\infty\text{Grpd}$ from the identity map to a map that factors through the point. It follows by prop 3.8.5 that $\Pi(\exp(\mathfrak{g})_n) \simeq *$ for all $n \in \mathbb{N}$. And since Π preserves the homotopy colimit $\exp(\mathfrak{g}) \simeq \mathbb{L}\lim_{\rightarrow n} \exp(\mathfrak{g})_n$ we have that $\Pi(\exp(\mathfrak{g})) \simeq *$, too. \square

We may think of $\exp(\mathfrak{g})$ as the smooth geometrically ∞ -*simply connected Lie integration* of \mathfrak{g} . Notice however that $\exp(\mathfrak{g}) \in \text{Smooth}\infty\text{Grpd}$ in general has nontrivial and interesting homotopy sheaves. The above statement says that its *geometric homotopy groups* vanish .

4.4.14.1 Examples Let $\mathfrak{g} \in L_\infty$ be an ordinary (finite dimensional) Lie algebra. Standard Lie theory provides a simply connected Lie group G integrating \mathfrak{g} . Write $\mathbf{BG} \in \text{Smooth}\infty\text{Grpd}$ for its delooping. According to prop. 4.4.19 this is presented by the simplicial presheaf $\mathbf{BG}_{\text{ch}} \in [\text{CartSp}_{\text{smooth}}^{\text{op}}, \text{sSet}]$.

Proposition 4.4.60. *The operation of parallel transport $P \exp(\int -) : \Omega^1([0, 1], \mathfrak{g}) \rightarrow G$ yields a weak equivalence (in $[\text{CartSp}_{\text{smooth}}^{\text{op}}, \text{sSet}]_{\text{proj}}$)*

$$P \exp(\int -) : \mathbf{cosk}_3 \exp(\mathfrak{g}) \simeq \mathbf{cosk}_2 \exp(\mathfrak{g}) \simeq \mathbf{BG}_{\text{ch}} .$$

Proof. Notice that a flat smooth \mathfrak{g} -valued 1-form on a contractible space X is after a choice of basepoint canonically identified with a smooth function $X \rightarrow G$. The claim then follows from the observation that by the fact that G is simply connected any two paths with coinciding endpoints have a continuous homotopy between them, and that for smooth paths this may be chose to be smooth, by the Steenrod approximation theorem [Wock09]. \square

Let now $n \in \mathbb{N}$, $n \geq 1$.

Definition 4.4.61. Write

$$b^{n-1}\mathbb{R} \in L_\infty$$

for the L_∞ -algebra whose Chevalley-Eilenberg algebra is given by a single generator in degree n and vanishing differential. We call this the *line Lie n -algebra*.

Observation 4.4.62. The discrete ∞ -groupoid underlying $\exp(b^{n-1}\mathbb{R})$ is given by the Kan complex that in degree k has the set of closed differential n -forms with sitting instants on the k -simplex

$$\Gamma(\exp(b^{n-1}\mathbb{R})) : [k] \mapsto \Omega_{\text{si,cl}}^n(\Delta^k)$$

Definition 4.4.63. We write equivalently

$$\mathbf{B}^n\mathbb{R}_{\text{smp}} := \exp(b^{n-1}\mathbb{R}) \in [\text{CartSp}_{\text{smooth}}^{\text{op}}, \text{sSet}].$$

Proposition 4.4.64. *We have that $\mathbf{B}^n\mathbb{R}_{\text{smp}}$ is indeed a presentation of the smooth line n -group $\mathbf{B}^n\mathbb{R}$, from 4.4.21.*

Concretely, with $\mathbf{B}^n\mathbb{R}_{\text{chn}} \in [\text{CartSp}_{\text{smooth}}^{\text{op}}, \text{sSet}]$ the standard presentation given under the Dold-Kan correspondence by the chain complex of sheaves concentrated in degree n on $C^\infty(-, \mathbb{R})$ the equivalence is induced by the fiber integration of differential n -forms over the n -simplex:

$$\int_{\Delta^\bullet} : \mathbf{B}^n\mathbb{R}_{\text{smp}} \xrightarrow{\cong} \mathbf{B}^n\mathbb{R}_{\text{smp}}.$$

Proof. First we observe that the map

$$\int_{\Delta^\bullet} : (\omega \in \Omega_{\text{si,vert,cl}}^n(U \times \Delta^k)) \mapsto \int_{\Delta^k} \omega \in C^\infty(U, \mathbb{R})$$

is indeed a morphism of simplicial presheaves $\exp(b^{n-1}\mathbb{R}) \rightarrow \mathbf{B}^n\mathbb{R}_{\text{chn}}$ on. Since it goes between presheaves of abelian simplicial groups, by the Dold-Kan correspondence it is sufficient to check that we have a morphism of chain complexes of presheaves on the corresponding normalized chain complexes.

The only nontrivial degree to check is degree n . Let $\lambda \in \Omega_{\text{si,vert,cl}}^n(\Delta^{n+1})$. The differential of the normalized chains complex sends this to the signed sum of its restrictions to the n -faces of the $(n+1)$ -simplex. Followed by the integral over Δ^n this is the piecewise integral of λ over the boundary of the n -simplex. Since λ has sitting instants, there is $0 < \epsilon \in \mathbb{R}$ such that there are no contributions to this integral in an ϵ -neighbourhood of the $(n-1)$ -faces. Accordingly the integral is equivalently that over the smooth surface inscribed into the $(n+1)$ -simplex. Since λ is a closed form on the n -simplex, this surface integral vanishes, by the Stokes theorem. Hence \int_{Δ^\bullet} is indeed a chain map.

It remains to show that $\int_{\Delta^\bullet} : \mathbf{cosk}_{n+1} \exp(b^{n-1}\mathbb{R}) \rightarrow \mathbf{B}^n\mathbb{R}_{\text{chn}}$ is an isomorphism on simplicial homotopy groups over each $U \in \text{CartSp}$. This amounts to the statement that

- a smooth family of closed $n < k$ -forms with sitting instants on the boundary of Δ^{k+1} may be extended to a smooth family of closed forms with sitting instants on Δ^{k+1}
- a smooth family of closed n -forms with sitting instants on the boundary of Δ^{n+1} may be extended to a smooth family of closed forms with sitting instants on Δ^{n+1} precisely if their smooth family of integrals over $\partial\Delta^{n+1}$ vanishes.

To demonstrate this, we want to work with forms on the $(k+1)$ -ball instead of the $(k+1)$ -simplex. To achieve this, choose again $0 < \epsilon \in \mathbb{R}$ and construct the diffeomorphic image of $S^k \times [1-\epsilon, 1]$ inside the $(k+1)$ -simplex as indicated by the above construction: outside an ϵ -neighbourhood of the corners the image is a rectangular ϵ -thickening of the faces of the simplex. Inside the ϵ -neighbourhoods of the corners it bends smoothly. By the Steenrod-approximation theorem [Wock09] the diffeomorphism from this ϵ -thickening of the smoothed boundary of the simplex to $S^k \times [0, 1]$ extends to a smooth function from the $(k+1)$ -simplex to the $(k+1)$ -ball. By choosing ϵ smaller than each of the sitting instants of the given n -form on $\partial\Delta^k$, we

have that this n -form vanishes on the ϵ -neighbourhoods of the corners and is hence entirely determined by its restriction to the smoothed simplex, identified with the $(k+1)$ -ball.

It is now sufficient to show: a smooth family of smooth n -forms $\omega \in \Omega_{\text{vert,cl}}^n(U \times S^k)$ extends to a smooth family of closed n -forms $\hat{\omega} \in \Omega_{\text{vert,cl}}^n(U \times B^{n+1})$ that is radially constant in a neighbourhood of the boundary for all $n < k$ and for $n = k$ precisely if its smooth family of integrals $\int_{S^n} \omega = 0 \in C^\infty(U, \mathbb{R})$ vanishes.

Notice that over the point this is a direct consequence of the de Rham theorem: all $k < n$ forms are exact on S^k and n -forms are exact precisely if their integral vanishes. In that case there is an $(n-1)$ -form A with $\omega = dA$. Choosing any smoothing function $f : [0, 1] \rightarrow [0, 1]$ (smooth, surjective non-decreasing and constant in a neighbourhood of the boundary) we obtain a n -form $f \wedge A$ on $(0, 1] \times S^n$, vertically constant in a neighbourhood of the ends of the interval, equal to A at the top and vanishing at the bottom. Pushed forward along the canonical $(0, 1] \times S^n \rightarrow D^{n+1}$ this defines a form on the $(n+1)$ -ball, that we denote by the same symbol $f \wedge A$. Then the form $\hat{\omega} := d(f \wedge A)$ solves the problem.

To complete the proof we have to show that this argument does extend to smooth families of forms in that we can find suitable smooth families of the form A in the above discussion. This may be accomplished for instance by invoking Hodge theory: If we equip S^k with a Riemannian metric then the refined form of the Hodge theorem says that we have an equality

$$\text{id} - \pi_{\mathcal{H}} = [d, d^*G],$$

of operators on differential forms, where $\pi_{\mathcal{H}}$ is the orthogonal projection on harmonic forms and G is the Green operator of the Hodge-Laplace operator. For ω an exact form its harmonic projection vanishes so that this gives a homotopy

$$\omega = d(d^*G\omega).$$

This operation $\omega \mapsto d^*G\omega$ depends smoothly on ω . □

4.4.14.2 Flat coefficient objects for exponentiated L_∞ -algebras. We consider now the flat coefficient object, 3.8.5, $\flat \exp(\mathfrak{g})$ of exponentiated L_∞ algebras $\exp(\mathfrak{g})$, 4.4.14.

Definition 4.4.65. Write $\flat \exp(\mathfrak{g})_{\text{smp}}$ or equivalentl $\exp(\mathfrak{g})_{\text{flat}}$ for the simplicial presheaf given by

$$\flat \exp(\mathfrak{g})_{\text{smp}} : (U, [n]) \mapsto \text{Hom}_{\text{dgAlg}}(\text{CE}(\mathfrak{g}), \Omega_{\text{si}}^\bullet(U \times \Delta^n)).$$

Proposition 4.4.66. *The canonical morphism $\flat \mathbf{B}^n \mathbb{R} \rightarrow \mathbf{B}^n \mathbb{R}$ in $\text{Smooth}_\infty \text{Grpd}$ is presented in $[\text{CartSp}_{\text{smooth}}^{\text{op}}, \text{sSet}]$ by the composite*

$$\text{const } \Gamma \exp(b^{n-1} \mathbb{R}) \xrightarrow{\cong} \flat \exp(b^{n-1} \mathbb{R})_{\text{smp}} \longrightarrow \exp(b^{n-1} \mathbb{R}),$$

where the first morphism is a weak equivalence and the second a fibration in $[\text{CartSp}_{\text{smooth}}^{\text{op}}, \text{sSet}]_{\text{proj}}$.

We discuss the two morphisms in the composite separately in two lemmas.

Lemma 4.4.67. *The canonical inclusion*

$$\text{const } \Gamma(\exp(\mathfrak{g})) \rightarrow \flat \exp(\mathfrak{g})_{\text{smp}}$$

is a weak equivalence in $[\text{CartSp}^{\text{op}}, \text{sSet}]_{\text{proj}}$.

Proof. The morphism in question is on each object $U \in \text{CartSp}$ the morphism of simplicial sets

$$\text{Hom}_{\text{dgAlg}}(\text{CE}(\mathfrak{g}), \Omega_{\text{si}}^\bullet(\Delta^k)) \rightarrow \text{Hom}_{\text{dgAlg}}(\text{CE}(\mathfrak{g}), \Omega_{\text{si}}^\bullet(U \times \Delta^k)),$$

which is given by pullback of differential forms along the projection $U \times \Delta^k \rightarrow \Delta^k$.

To show that for fixed U this is a weak equivalence in the standard model structure on simplicial sets we produce objectwise a left inverse

$$F_U : \text{Hom}_{\text{d}\mathfrak{g}\text{Alg}}(\text{CE}(\mathfrak{g}), \Omega_{\text{si}}^\bullet(U \times \Delta^\bullet)) \rightarrow \text{Hom}_{\text{d}\mathfrak{g}\text{Alg}}(\text{CE}(\mathfrak{g}), \Omega_{\text{si}}^\bullet(\Delta^\bullet))$$

and show that this is an acyclic fibration of simplicial sets. The statement then follows by the 2-out-of-3-property of weak equivalences.

We take F_U to be given by evaluation at $0 : * \rightarrow U$, i.e. by postcomposition with the morphisms

$$\Omega^\bullet(U \times \Delta^k) \xrightarrow{\text{Id} \times 0^*} \Omega^\bullet(* \times \Delta^k) = \Omega^\bullet(\Delta^k).$$

(This is, of course, not natural in U and hence does not extend to a morphism of simplicial presheaves. But for our argument here it need not.) The morphism F_U is an acyclic Kan fibration precisely if all diagrams of the form

$$\begin{array}{ccc} \partial\Delta[n] & \longrightarrow & \text{Hom}(\text{CE}(\mathfrak{g}), \Omega_{\text{si}}^\bullet(U \times \Delta^\bullet)) \\ \downarrow & & \downarrow F_U \\ \Delta[n] & \longrightarrow & \text{Hom}(\text{CE}(\mathfrak{g}), \Omega_{\text{si}}^\bullet(\Delta^\bullet)) \end{array}$$

have a lift. Using the Yoneda lemma over the simplex category and since the differential forms on the simplices have sitting instants, we may, as above, equivalently reformulate this in terms of spheres as follows: for every morphism $\text{CE}(\mathfrak{g}) \rightarrow \Omega_{\text{si}}^\bullet(D^n)$ and morphism $\text{CE}(\mathfrak{g}) \rightarrow \Omega_{\text{si}}^\bullet(U \times S^{n-1})$ such that the diagram

$$\begin{array}{ccc} \text{CE}(\mathfrak{g}) & \longrightarrow & \Omega^\bullet(U \times S^{n-1}) \\ \downarrow & & \downarrow \\ \Omega_{\text{si}}^\bullet(D^n) & \longrightarrow & \Omega^\bullet(S^{n-1}) \end{array}$$

commutes, this may be factored as

$$\begin{array}{ccc} \text{CE}(\mathfrak{g}) & & \\ \searrow & & \\ \Omega_{\text{si}}^\bullet(U \times D^n) & \longrightarrow & \Omega^\bullet(U \times S^{n-1}) \\ \downarrow & & \downarrow \\ \Omega^\bullet(D^n) & \longrightarrow & \Omega^\bullet(S^{n-1}) \end{array}$$

(Here the subscript “_{si}” denotes differential forms on the disk that are radially constant in a neighbourhood of the boundary.)

This factorization we now construct. Let first $f : [0, 1] \rightarrow [0, 1]$ be any smoothing function, i.e. a smooth function which is surjective, non-decreasing, and constant in a neighbourhood of the boundary. Define a smooth map $U \times [0, 1] \rightarrow U$ by $(u, \sigma) \mapsto u \cdot f(1 - \sigma)$, where we use the multiplicative structure on the Cartesian space U . This function is the identity at $\sigma = 0$ and is the constant map to the origin at $\sigma = 1$. It exhibits a smooth contraction of U .

Pullback of differential forms along this map produces a morphism

$$\Omega^\bullet(U \times S^{n-1}) \rightarrow \Omega^\bullet(U \times S^{n-1} \times [0, 1])$$

which is such that a form ω is sent to a form which in a neighbourhood $(1 - \epsilon, 1]$ of $1 \in [0, 1]$ is constant along $(1 - \epsilon, 1] \times U$ on the value $(0, \text{Id}_{S^{n-1}})^* \omega$.

Let now $0 < \epsilon \in \mathbb{R}$ some value such that the given forms $CE(\mathfrak{g}) \rightarrow \Omega_{\text{si}}^\bullet(D^k)$ are constant a distance $d \leq \epsilon$ from the boundary of the disk. Let $q : [0, \epsilon/2] \rightarrow [0, 1]$ be given by multiplication by $1/(\epsilon/2)$ and $h : D_{1-\epsilon/2}^k \rightarrow D_1^n$ the injection of the n -disk of radius $1 - \epsilon/2$ into the unit n -disk.

We can then glue to the morphism

$$CE(\mathfrak{g}) \rightarrow \Omega^\bullet(U \times S^{n-1}) \rightarrow \Omega^\bullet(U \times [0, 1] \times S^{n-1}) \xrightarrow{id \times q^* \times id} \Omega^\bullet(U \times [0, \epsilon/2] \times S^{n-1})$$

to the morphism

$$CE(\mathfrak{g}) \rightarrow \Omega^\bullet(D^n) \rightarrow \Omega^\bullet(U \times \{1\} \times D^n) \xrightarrow{h^*} \Omega^\bullet(U \times \{1\} \times D_{1-\epsilon/2}^n)$$

by smoothly identifying the union $[0, \epsilon/2] \times S^{n-1} \coprod_{S^{n-1}} D_{1-\epsilon/2}^n$ with D^n (we glue a disk into an annulus to obtain a new disk) to obtain in total a morphism

$$CE(\mathfrak{g}) \rightarrow \Omega^\bullet(U \times D^n)$$

with the desired properties: at $u = 0$ the homotopy that we constructed is constant and the above construction hence restricts the forms to radius $\leq 1 - \epsilon/2$ and then extends back to radius ≤ 1 by the constant value that they had before. Away from 0 the homotopy in the remaining $\epsilon/2$ bit smoothly interpolates to the boundary value. \square

Lemma 4.4.68. *The canonical morphism*

$$\flat \exp(\mathfrak{g})_{\text{smp}} \rightarrow \exp(\mathfrak{g})$$

is a fibration in $[\text{CartSp}_{\text{smooth}}^{\text{op}}, \text{sSet}]_{\text{proj}}$.

Proof. Over each $U \in \text{CartSp}$ the morphism is induced from the morphism of dg-algebras

$$\Omega^\bullet(U) \rightarrow C^\infty(U)$$

that discards all differential forms of non-vanishing degree.

It is sufficient to show that for

$$CE(\mathfrak{g}) \rightarrow \Omega_{\text{si,vert}}^\bullet(U \times (D^n \times [0, 1]))$$

a morphism and

$$CE(\mathfrak{g}) \rightarrow \Omega_{\text{si}}^\bullet(U \times D^n)$$

a lift of its restriction to $\sigma = 0 \in [0, 1]$ we have an extension to a lift

$$CE(\mathfrak{g}) \rightarrow \Omega_{\text{si,vert}}^\bullet(U \times (D^n \times [0, 1])).$$

From these lifts all the required lifts are obtained by precomposition with some evident smooth retractions.

The lifts in question are obtained from solving differential equations with boundary conditions, and exist due to the existence of solutions of first order systems of partial differential equations and the identity $d_{\text{dR}}^2 = 0$. \square

We have discussed now two different presentations for the flat coefficient object $\flat \mathbf{B}^n \mathbb{R}$:

1. $\flat \mathbf{B}^n \mathbb{R}_{\text{chn}}$ – prop. 4.4.46;
2. $\flat \mathbf{B}^n \mathbb{R}_{\text{smp}}$ – prop. 4.4.66;

There is an evident degreewise map

$$(-1)^{\bullet+1} \int_{\Delta^\bullet} : \mathfrak{b}\mathbf{B}^n \mathbb{R}_{\text{smp}} \rightarrow \mathfrak{b}\mathbf{B}^n \mathbb{R}_{\text{chn}}$$

that sends a closed n -form $\omega \in \Omega_{\text{cl}}^n(U \times \Delta^k)$ to $(-1)^{k+1}$ times its fiber integration $\int_{\Delta^k} \omega$.

Proposition 4.4.69. *This map yields a morphism of simplicial presheaves*

$$\int : \mathfrak{b}\mathbf{B}^n \mathbb{R}_{\text{smp}} \rightarrow \mathfrak{b}\mathbf{B}^n \mathbb{R}_{\text{chn}}$$

which is a weak equivalence in $[\text{CartSp}^{\text{op}}, \text{sSet}]_{\text{proj}}$.

Proof. First we check that we have a morphism of simplicial sets over each $U \in \text{CartSp}$. Since both objects are abelian simplicial groups we may, by the Dold-Kan correspondence, check the statement for sheaves of normalized chain complexes.

Notice that the chain complex differential on the forms $\omega \in \Omega_{\text{cl}}^n(U \times \Delta^k)$ on simplices sends a form to the alternating sum of its restriction to the faces of the simplex. Postcomposed with the integration map this is the operation $\omega \mapsto \int_{\partial \Delta^k} \omega$ of integration over the boundary.

Conversely, first integrating over the simplex and then applying the de Rham differential on U yields

$$\begin{aligned} \omega \mapsto (-1)^{k+1} d_U \int_{\Delta^k} \omega &= - \int_{\Delta^k} d_U \omega \\ &= \int_{\Delta^k} d_{\Delta^k} \omega \quad , \\ &= \int_{\partial \Delta^k} \omega \end{aligned}$$

where we first used that ω is closed, so that $d_{\text{dR}} \omega = (d_U + d_{\Delta^k}) \omega = 0$, and then used Stokes' theorem. Therefore we have indeed objectwise a chain map.

By the discussion of the two objects we already know that both present the homotopy type of $\mathfrak{b}\mathbf{B}^n \mathbb{R}$. Therefore it suffices to show that the integration map is over each $U \in \text{CartSp}$ an isomorphism on the simplicial homotopy group in degree n .

Clearly the morphism

$$\int_{\Delta^n} : \Omega_{\text{si,cl}}^{\bullet}(U \times \Delta^n) \rightarrow C^\infty(U, \mathbb{R})$$

is surjective on degree n homotopy groups: for $f : U \rightarrow * \rightarrow \mathbb{R}$ constant, a preimage is $f \cdot \text{vol}_{\Delta^n}$, the normalized volume form of the n -simplex times f . Moreover, these preimages clearly span the whole homotopy group $\pi_n(\mathfrak{b}\mathbf{B}^n \mathbb{R}) \simeq \mathbb{R}_{\text{disc}}$ (they are in fact the images of the weak equivalence $\text{const} \Gamma \exp(b^{n-1} \mathbb{R}) \rightarrow \mathfrak{b}\mathbf{B}^n \mathbb{R}_{\text{smp}}$) and the integration map is injective on them. Therefore it is an isomorphism on the homotopy groups in degree n . \square

4.4.14.3 de Rham coefficients We now consider the de Rham coefficient object $\mathfrak{b}_{\text{dR}} \exp(\mathfrak{g})$, 3.9.3, of exponentiated L_∞ algebras $\exp(\mathfrak{g})$, def 4.4.56.

Proposition 4.4.70. *For $\mathfrak{g} \in L_\infty$ a representative in $[\text{CartSp}^{\text{op}}, \text{sSet}]_{\text{proj}}$ of the de Rham coefficient object $\mathfrak{b}_{\text{dR}} \exp(\mathfrak{g})$ is given by the presheaf*

$$\mathfrak{b}_{\text{dR}} \mathbf{B}^n \mathbb{R}_{\text{smp}} : (U, [n]) \mapsto \text{Hom}_{\text{dgAlg}}(\text{CE}(\mathfrak{g}), \Omega_{\text{si}}^{\bullet \geq 1, \bullet}(U \times \Delta^n)),$$

where the notation on the right denotes the dg-algebra of differential forms on $U \times \Delta^n$ that (apart from having sitting instants on the faces of Δ^n) are along U of non-vanishing degree.

Proof. By the prop. 4.4.66 we may present the defining ∞ -pullback $b_{dR}\mathbf{B}^n\mathbb{R} := * \times_{\mathbf{B}^n\mathbb{R}} b\mathbf{B}^n\mathbb{R}$ in $\text{Smooth}\infty\text{Grpd}$ by the ordinary pullback

$$\begin{array}{ccc} b_{dR}\mathbf{B}^n\mathbb{R}_{\text{smp}} & \longrightarrow & b\mathbf{B}^n\mathbb{R}_{\text{smp}} \\ \downarrow & & \downarrow \\ * & \longrightarrow & \mathbf{B}^n\mathbb{R} \end{array}$$

in $[\text{CartSp}_{\text{smooth}}^{\text{op}}, \text{sSet}]$. □

We have discussed now two different presentations for the de Rham coefficient object $b\mathbf{B}^n\mathbb{R}$:

1. $b_{dR}\mathbf{B}^n\mathbb{R}_{\text{chn}}$ – prop. 4.4.49;
2. $b_{dR}\mathbf{B}^n\mathbb{R}_{\text{smp}}$ – prop. 4.4.70;

There is an evident degreewise map

$$(-1)^{\bullet+1} \int_{\Delta^\bullet} : b_{dR}\mathbf{B}^n\mathbb{R}_{\text{smp}} \rightarrow b_{dR}\mathbf{B}^n\mathbb{R}_{\text{chn}}$$

that sends a closed n -form $\omega \in \Omega_{\text{cl}}^n(U \times \Delta^k)$ to $(-1)^{k+1}$ times its fiber integration $\int_{\Delta^k} \omega$.

Proposition 4.4.71. *This map yields a morphism of simplicial presheaves*

$$\int : b_{dR}\mathbf{B}^n\mathbb{R}_{\text{smp}} \rightarrow b_{dR}\mathbf{B}^n\mathbb{R}_{\text{chn}}$$

which is a weak equivalence in $[\text{CartSp}^{\text{op}}, \text{sSet}]_{\text{proj}}$.

Proof. This morphism is the morphism on pullbacks induced from the weak equivalence of diagrams

$$\begin{array}{ccccc} * & \longrightarrow & \exp(b^{n-1}\mathbb{R}) & \longleftarrow & b\mathbf{B}^n\mathbb{R}_{\text{smp}} \\ \downarrow = & & \downarrow f & & \downarrow f \\ * & \longrightarrow & \mathbf{B}^n\mathbb{R}_{\text{chn}} & \longleftarrow & b\mathbf{B}^n\mathbb{R}_{\text{chn}} \end{array}$$

Since both of these pullbacks are homotopy pullbacks by the above discussion, the induced morphism between the pullbacks is also a weak equivalence. □

4.4.15 Maurer-Cartan forms and curvature characteristic forms

We discuss the universal curvature forms, 3.9.5, in $\text{Smooth}\infty\text{Grpd}$.

Specifically, we discuss the canonical Maurer-Cartan form on the following special cases of (presentations of) smooth ∞ -groups.

- 4.4.15.1 – ordinary Lie groups:
- 4.4.15.2 – circle n -groups $\mathbf{B}^{n-1}U(1)$;
- 4.4.15.3 – simplicial Lie groups.

Notice that, by the discussion in 2.2.6, the case of simplicial Lie groups also subsumes the case of crossed modules of Lie groups, def. 1.2.74, and generally of crossed complexes of Lie groups, def. 1.2.89.

4.4.15.1 Canonical form on an ordinary Lie group

Proposition 4.4.72. *Let G be a Lie group with Lie algebra \mathfrak{g} .*

Under the identification

$$\text{Smooth}\infty\text{Grpd}(X, \mathfrak{b}_{\text{dR}}\mathbf{B}G) \simeq \Omega_{\text{flat}}^1(X, \mathfrak{g})$$

from prop. 4.4.47, for $X \in \text{SmoothMfd}$, we have that the canonical morphism

$$\theta : G \rightarrow \mathfrak{b}_{\text{dR}}\mathbf{B}G$$

in $\text{Smooth}\infty\text{Grpd}$ corresponds to the ordinary Maurer-Cartan form on G .

Proof. We compute the defining double ∞ -pullback

$$\begin{array}{ccc} G & \longrightarrow & * \\ \theta \downarrow & & \downarrow \\ \mathfrak{b}_{\text{dR}}\mathbf{B}G & \longrightarrow & \mathfrak{b}\mathbf{B}G \\ \downarrow & & \downarrow \\ * & \longrightarrow & \mathbf{B}G \end{array}$$

in $\text{Smooth}\infty\text{Grpd}$ as a homotopy pullback in $[\text{CartSp}_{\text{smooth}}^{\text{op}}, \text{sSet}]_{\text{proj}}$. In prop. 4.4.47 we already modeled the lower ∞ -pullback square by the ordinary pullback

$$\begin{array}{ccc} \mathfrak{b}_{\text{dR}}\mathbf{B}G_{\text{ch}} & \longrightarrow & \mathfrak{b}\mathbf{B}G_{\text{ch}} \\ \downarrow & & \downarrow \\ * & \longrightarrow & \mathbf{B}G_{\text{ch}} \end{array} .$$

A standard fibration replacement of the point inclusion $* \rightarrow \mathfrak{b}\mathbf{B}G$ is given by replacing the point by the presheaf that assigns groupoids of the form

$$Q : U \mapsto \left\{ \begin{array}{ccc} & A_0 = 0 & \\ g_1 \swarrow & & \searrow g_2 \\ A_1 & \xrightarrow{h} & A_2 \end{array} \right\} ,$$

where on the right the commuting triangle is in $(\mathfrak{b}_{\text{dR}}\mathbf{B}G_{\text{ch}})(U)$ and here regarded as a morphism from (g_1, A_1) to (g_2, A_2) . And the fibration $Q \rightarrow \mathfrak{b}\mathbf{B}G_{\text{ch}}$ is given by projecting out the base of these triangles.

The pullback of this along $\mathfrak{b}_{\text{dR}}\mathbf{B}G_{\text{ch}} \rightarrow \mathfrak{b}\mathbf{B}G_{\text{ch}}$ is over each U the restriction of the groupoid $Q(U)$ to its set of objects, hence is the sheaf

$$U \mapsto \left\{ \begin{array}{c} A_0 = 0 \\ \downarrow g \\ g^*\theta \end{array} \right\} \simeq C^\infty(U, G) = G(U) ,$$

equipped with the projection

$$t_U : G \rightarrow \mathfrak{b}_{\text{dR}}\mathbf{B}G_{\text{ch}}$$

given by

$$t_U : (g : U \rightarrow G) \mapsto g^*\theta .$$

Under the Yoneda lemma (over SmoothMfd) this identifies the morphism t with the Maurer-Cartan form $\theta \in \Omega_{\text{flat}}^1(G, \mathfrak{g})$. \square

4.4.15.2 Canonical form on the circle n -group We consider now the canonical differential form on the circle Lie $(n + 1)$ -group, def. 4.4.21. Below in 4.4.16 this serves as the *universal curvature class* on the universal circle n -bundle.

Definition 4.4.73. For $n \in \mathbb{N}$, write

$$\mathbf{B}^n U(1)_{\text{diff,chn}} := \text{DK} \left(\begin{array}{ccccccc} & U(1) & \xrightarrow{d_{\text{dR}}} & \Omega^1 & \longrightarrow & \dots & \longrightarrow & \Omega^{n-1} & \xrightarrow{d_{\text{dR}}} & \Omega^n \\ & \nearrow & \oplus & \nearrow & \oplus & & & \oplus & \nearrow & \oplus & \nearrow & (-1)^n \text{id} \\ 0 & \longrightarrow & \Omega^1 & \xrightarrow{d_{\text{dR}}} & \Omega^2 & \longrightarrow & \dots & \longrightarrow & \Omega^n & & & \end{array} \right) \in [\text{CartSp}^{\text{op}}, \text{sSet}]$$

for the simplicial presheaf which is the image under the Dold-Kan map, prop. 2.2.31, of the chain complex on the right as indicated. (Here we display morphisms between direct sums of presheaves of chain complexes by their matrix components, as usual). Write moreover

$$\text{curv}_{\text{chn}} : \mathbf{B}^n U(1)_{\text{diff,chn}} \rightarrow \mathfrak{b}_{\text{dR}} \mathbf{B}^{n+1} U(1)_{\text{chn}}$$

for the morphism of simplicial presheaves which is the image under the Dold-Kan map, prop. 2.2.31 of the morphism of sheaves of chain complexes which in components is given by

$$\begin{array}{ccc} \mathbf{B}^n U(1)_{\text{diff,chn}} & & \\ \downarrow \text{curv}_{\text{chn}} & & \\ \mathfrak{b}_{\text{dR}} \mathbf{B}^{n+1} U(1)_{\text{chn}} & & \\ & := \text{DK} & \left(\begin{array}{ccccccc} & U(1) & \xrightarrow{d_{\text{dR}}} & \Omega^1 & \longrightarrow & \dots & \longrightarrow & \Omega^{n-1} & \xrightarrow{d_{\text{dR}}} & \Omega^n \\ & \nearrow & \oplus & \nearrow & \oplus & & & \oplus & \nearrow & \oplus & \nearrow & (-1)^n \text{id} \\ 0 & \longrightarrow & \Omega^1 & \xrightarrow{d_{\text{dR}}} & \Omega^2 & \longrightarrow & \dots & \longrightarrow & \Omega^n & & & \\ & & \downarrow & & \downarrow & & & \downarrow & & \downarrow & & \\ & & (-1)^n \text{id} & & (-1)^n \text{id} & & & (-1)^n \text{id} & & & & \\ & & \downarrow & & \downarrow & & & \downarrow & & \downarrow & & \\ 0 & \longrightarrow & \Omega^1 & \xrightarrow{d_{\text{dR}}} & \Omega^2 & \longrightarrow & \dots & \longrightarrow & \Omega^n & \xrightarrow{d_{\text{dR}}} & \Omega_{\text{cl}}^{n+1} & \end{array} \right) \end{array}$$

Proposition 4.4.74. *The evident projection morphism*

$$\mathbf{B}^n U(1)_{\text{diff,chn}} \xrightarrow{\simeq} \mathbf{B}^n U(1)_{\text{chn}}$$

is a weak equivalence in $[\text{CartSp}, \text{sSet}]_{\text{proj}}$. Moreover, the span

$$\begin{array}{ccc} \mathbf{B}^n U(1)_{\text{diff,chn}} & \xrightarrow{\text{curv}_{\text{chn}}} & \mathfrak{b}_{\text{dR}} \mathbf{B}^{n+1} U(1)_{\text{chn}} \\ \downarrow \simeq & & \\ \mathbf{B}^n U(1)_{\text{chn}} & & \end{array}$$

is a presentation in $[\text{CartSp}^{\text{op}}, \text{sSet}]_{\text{proj,loc}}$ of the universal curvature characteristic, def. 3.9.32, $\text{curv} : \mathbf{B}^n U(1) \rightarrow \mathfrak{b}_{\text{dR}} \mathbf{B}^{n+1} U(1)$ in $\text{Smooth}\infty\text{Grpd}$.

Proof. By prop. 2.3.13 we may present the defining ∞ -pullback

$$\begin{array}{ccc} \mathbf{B}^n U(1) & \longrightarrow & * \\ \text{curv} \downarrow & & \downarrow \\ \mathfrak{b}_{\text{dR}} \mathbf{B}^{n+1} U(1) & \longrightarrow & \mathfrak{b} \mathbf{B}^{n+1} U(1) \\ \downarrow & & \downarrow \\ * & \longrightarrow & \mathbf{B}^{n+1} U(1) \end{array}$$

in $\text{Smooth}\infty\text{Grpd}$ by a homotopy pullback in $[\text{CartSp}^{\text{op}}, \text{sSet}]_{\text{proj}}$. We claim that there is a commuting diagram

$$\begin{array}{ccc}
[0 \rightarrow C^\infty(-, U(1)) \oplus \Omega^1(-) \xrightarrow{d_{\text{dR}} - \text{Id}} \Omega^1(-) \oplus \Omega^2(-) \xrightarrow{d_{\text{dR}} + \text{Id}} \dots \xrightarrow{d_{\text{dR}} + \text{Id}} \Omega^n(-)] & \longrightarrow & [C^\infty(-, U(1)) \xrightarrow{d_{\text{dR}} + \text{Id}} C^\infty(-, U(1)) \oplus \Omega^1(-) \xrightarrow{d_{\text{dR}} - \text{Id}} \dots \xrightarrow{d_{\text{dR}} + \text{Id}} \Omega^n(-)] \\
\downarrow (p_2, p_2, \dots, d_{\text{dR}}) & & \downarrow (\text{Id}, p_2, p_2, \dots, p_2, d_{\text{dR}}) \\
[0 \rightarrow \Omega^1(-) \xrightarrow{d_{\text{dR}}} \Omega^2(-) \xrightarrow{d_{\text{dR}}} \dots \xrightarrow{d_{\text{dR}}} \Omega_{\text{cl}}^{n+1}(-)] & \longrightarrow & [C^\infty(-, U(1)) \xrightarrow{d_{\text{dR}}} \Omega^1(-) \xrightarrow{d_{\text{dR}}} \Omega^2(-) \xrightarrow{d_{\text{dR}}} \dots \xrightarrow{d_{\text{dR}}} \Omega_{\text{cl}}^{n+1}(-)] \\
\downarrow & & \downarrow \\
[0 \rightarrow 0 \rightarrow 0 \rightarrow \dots \rightarrow 0] & \longrightarrow & [C^\infty(-, U(1)) \rightarrow 0 \rightarrow 0 \rightarrow \dots \rightarrow 0]
\end{array}$$

in $[\text{CartSp}^{\text{op}}, \text{Ch}^+]_{\text{proj}}$, where

- the objects are fibrant models for the corresponding objects in the above ∞ -pullback diagram;
- the two right vertical morphisms are fibrations;
- the two squares are pullback squares.

This implies that under the right adjoint Ξ we have a homotopy pullback as claimed. In full detail, the diagram of morphisms of sheaves that exhibits this diagram of morphisms of complexes of sheaves is

That the lower square here is a pullback is prop. 4.4.49. For the upper square the same type of reasoning applies. The main point is to find the chain complex in the top right such that it is a resolution of the point and maps by a fibration onto our model for $\mathfrak{b}\mathbf{B}^n U(1)$. This is the mapping cone of the identity on the Deligne complex, as indicated. The vertical morphism out of it is manifestly surjective (by the Poincaré lemma applied to each object $U \in \text{CartSp}$) hence this is a fibration. \square

In prop. 4.4.70 we had discussed an alternative equivalent presentation of de Rham coefficient objects above. We now formulate the curvature characteristic in this alternative form.

Observation 4.4.75. We may write the simplicial presheaf $\flat_{\text{dR}}\mathbf{B}^{n+1}\mathbb{R}_{\text{smp}}$ from prop.4.4.70 equivalently as follows

$$\flat_{\text{dR}}\mathbf{B}^{n+1}\mathbb{R}_{\text{smp}} : (U, [k]) \mapsto \left\{ \begin{array}{ccc} \Omega_{\text{si,vert}}^{\bullet}(U \times \Delta^k) & \longleftarrow & 0 \\ \uparrow & & \uparrow \\ \Omega_{\text{si}}^{\bullet}(U \times \Delta^k) & \longleftarrow & \text{CE}(b^n\mathbb{R}) \end{array} \right\},$$

where on the right we have the set of commuting diagrams in dgAlg of the given form, with the vertical morphisms being the canonical projections.

Definition 4.4.76. Write $W(b^{n-1}\mathbb{R}) \in \text{dgAlg}$ for the Weil algebra of the line Lie n -algebra, defined to be free commutative dg-algebra on a single generator in degree n , hence the graded commutative algebra on a generator in degree n and a generator in degree $(n+1)$ equipped with the differential that takes the former to the latter.

We write also $\text{inn}(b^{n-1})$ for the L_{∞} -algebra corresponding to the Weil algebra

$$\text{CE}(\text{inn}(b^{n-1})) := W(b^{n-1}\mathbb{R})$$

Observation 4.4.77. We have the following properties of $W(b^{n-1}\mathbb{R})$

1. There is a canonical natural isomorphism

$$\text{Hom}_{\text{dgAlg}}(W(b^{n-1}\mathbb{R}), \Omega^{\bullet}(U)) \simeq \Omega^n(U)$$

between dg-algebra homomorphisms $A : W(b^{n-1}\mathbb{R}) \rightarrow \Omega^{\bullet}(X)$ from the Weil algebra of $b^{n-1}\mathbb{R}$ to the de Rham complex and degree- n differential forms, not necessarily closed.

2. There is a canonical dg-algebra homomorphism $W(b^{n-1}\mathbb{R}) \rightarrow \text{CE}(b^{n-1}\mathbb{R})$ and the differential n -form corresponding to A factors through this morphism precisely if the curvature $d_{\text{dR}}A$ of A vanishes.
3. The image under $\exp(-)$

$$\exp(\text{inn}(b^{n-1})\mathbb{R}) \rightarrow \exp(b^n\mathbb{R})$$

of the canonical morphism $W(b^{n-1}\mathbb{R}) \leftarrow \text{CE}(b^n\mathbb{R})$ is a fibration in $[\text{CartSp}_{\text{smooth}}^{\text{op}}, \text{sSet}]_{\text{proj}}$ that presents the point inclusion $* \rightarrow \mathbf{B}^{n+1}\mathbb{R}$ in $\text{Smooth}\infty\text{Grpd}$.

Definition 4.4.78. Let $\mathbf{B}^n\mathbb{R}_{\text{diff,smp}} \in [\text{CartSp}_{\text{smooth}}^{\text{op}}, \text{sSet}]$ be the simplicial presheaf defined by

$$\mathbf{B}^n\mathbb{R}_{\text{diff,smp}} : (U, [k]) \mapsto \left\{ \begin{array}{ccc} \Omega_{\text{si,vert}}^{\bullet}(U \times \Delta^k) & \xleftarrow{A_{\text{vert}}} & \text{CE}(b^{n-1}\mathbb{R}) \\ \uparrow & & \uparrow \\ \Omega_{\text{si}}^{\bullet}(U \times \Delta^k) & \xleftarrow{A} & W(b^{n-1}\mathbb{R}) \end{array} \right\},$$

where on the right we have the set of commuting diagrams in dgAlg as indicated.

This means that an element of $\mathbf{B}^n\mathbb{R}_{\text{diff,smp}}(U)[k]$ is a smooth n -form A (with sitting instants) on $U \times \Delta^k$ such that its curvature $(n+1)$ -form dA vanishes when restricted in all arguments to vector fields tangent to Δ^k . We may write this condition as $d_{\text{dR}}A \in \Omega_{\text{si}}^{\bullet \geq 1, \bullet}(U \times \Delta^k)$.

Observation 4.4.79. There are canonical morphisms

$$\begin{array}{ccc} \mathbf{B}^n\mathbb{R}_{\text{diff,smp}} & \xrightarrow{\text{curv}_{\text{smp}}} & \flat_{\text{dR}}\mathbf{B}^n\mathbb{R}_{\text{smp}} \\ \downarrow \simeq & & \\ \mathbf{B}^n\mathbb{R}_{\text{smp}} & & \end{array}$$

in $[\text{CartSp}_{\text{smooth}}^{\text{op}}, \text{sSet}]$, where the vertical map is given by remembering only the top horizontal morphism in the above square diagram, and the horizontal morphism is given by forming the pasting composite

$$\text{curv}_{\text{smp}} : \left\{ \begin{array}{ccc} \Omega_{\text{si,vert}}^{\bullet}(U \times \Delta^k) & \xleftarrow{A_{\text{vert}}} & \text{CE}(b^{n-1}\mathbb{R}) \\ \uparrow & & \uparrow \\ \Omega_{\text{si}}^{\bullet}(U \times \Delta^k) & \xleftarrow{A} & \text{W}(b^{n-1}\mathbb{R}) \end{array} \right\} \\ \mapsto \left\{ \begin{array}{ccccc} \Omega_{\text{si,vert}}^{\bullet}(U \times \Delta^k) & \xleftarrow{A_{\text{vert}}} & \text{CE}(b^{n-1}\mathbb{R}) & \xleftarrow{\quad} & 0 \\ \uparrow & & \uparrow & & \uparrow \\ \Omega_{\text{si}}^{\bullet}(U \times \Delta^k) & \xleftarrow{A} & \text{W}(b^{n-1}\mathbb{R}) & \xleftarrow{\quad} & \text{CE}(b^n\mathbb{R}) \end{array} \right\}.$$

Proposition 4.4.80. *This span is a presentation in $[\text{CartSp}_{\text{smooth}}^{\text{op}}, \text{sSet}]$ of the universal curvature characteristics $\text{curv} : \mathbf{B}^n\mathbb{R} \rightarrow \mathfrak{b}_{\text{dR}}\mathbf{B}^{n+1}\mathbb{R}$, def. 3.9.32, in $\text{Smooth}\infty\text{Grpd}$.*

Proof. We need to produce a fibration resolution of the point inclusion $* \rightarrow \mathfrak{b}\mathbf{B}^{n+1}\mathbb{R}_{\text{smp}}$ in $[\text{CartSp}_{\text{smooth}}^{\text{op}}, \text{sSet}]_{\text{proj}}$ and then show that the above is the ordinary pullback of this along $\mathfrak{b}_{\text{dR}}\mathbf{B}^{n+1}\mathbb{R}_{\text{smp}} \rightarrow \mathfrak{b}\mathbf{B}^{n+1}\mathbb{R}_{\text{smp}}$.

We claim that this is achieved by the morphism

$$(U, [k]) : \{\Omega_{\text{si}}^{\bullet}(U \times \Delta^k) \leftarrow \text{W}(b^{n-1}\mathbb{R})\} \mapsto \{\Omega_{\text{si}}^{\bullet}(U \times \Delta^k) \leftarrow \text{W}(b^{n-1}\mathbb{R}) \leftarrow \text{CE}(b^n\mathbb{R})\}.$$

Here the simplicial presheaf on the left is that which assigns the set of arbitrary n -forms (with sitting instants but not necessarily closed) on $U \times \Delta^k$ and the map is simply given by sending such an n -form A to the $(n+1)$ -form $d_{\text{dR}}A$.

It is evident that the simplicial presheaf on the left resolves the point: since there is no condition on the forms every form on $U \times \Delta^k$ is in the image of the map of the normalized chain complex of a form on $U \times \Delta^{k+1}$: such is given by any form that is, up to a sign, equal to the given form on one n -face and 0 on all the other faces. Clearly such forms exist.

Moreover, this morphism is a fibration in $[\text{CartSp}_{\text{smooth}}^{\text{op}}, \text{sSet}]_{\text{proj}}$, for instance because its image under the normalized chains complex functor is a degreewise surjection, by the Poincaré lemma.

Now we observe that we have over each $(U, [k])$ a double pullback diagram in Set

$$\begin{array}{ccc}
\left\{ \begin{array}{ccc} \Omega_{\text{si,vert}}^\bullet(U \times \Delta^k) & \xleftarrow{A_{\text{vert}}} & \text{CE}(b^{n-1}\mathbb{R}) \\ \uparrow & & \uparrow \\ \Omega_{\text{si}}^\bullet(U \times \Delta^k) & \xleftarrow{A} & W(b^{n-1}\mathbb{R}) \end{array} \right\} & \rightarrow & \left\{ \begin{array}{ccc} \Omega_{\text{si,vert}}^\bullet(U \times \Delta^k) & \xleftarrow{} & W(b^{n-1}\mathbb{R}) \\ \uparrow & & \uparrow \text{id} \\ \Omega_{\text{si}}^\bullet(U \times \Delta^k) & \xleftarrow{} & W(b^{n-1}\mathbb{R}) \end{array} \right\} \\
\downarrow & & \downarrow \\
\left\{ \begin{array}{ccc} \Omega_{\text{si,vert}}^\bullet(U \times \Delta^k) & \xleftarrow{} & 0 \\ \uparrow & & \uparrow \\ \Omega_{\text{si}}^\bullet(U \times \Delta^k) & \xleftarrow{} & \text{CE}(b^n\mathbb{R}) \end{array} \right\} & \rightarrow & \left\{ \begin{array}{ccc} \Omega_{\text{si,vert}}^\bullet(U \times \Delta^k) & \xleftarrow{} & \text{CE}(b^n\mathbb{R}) \\ \uparrow & & \uparrow \text{id} \\ \Omega_{\text{si}}^\bullet(U \times \Delta^k) & \xleftarrow{} & \text{CE}(b^n\mathbb{R}) \end{array} \right\} , \\
\downarrow & & \downarrow \\
\left\{ \begin{array}{ccc} \Omega_{\text{si,vert}}^\bullet(U \times \Delta^k) & \xleftarrow{} & 0 \\ \uparrow & & \uparrow \\ \Omega_{\text{si}}^\bullet(U \times \Delta^k) & \xleftarrow{} & 0 \end{array} \right\} & \rightarrow & \left\{ \begin{array}{ccc} \Omega_{\text{si,vert}}^\bullet(U \times \Delta^k) & \xleftarrow{} & \text{CE}(b^n\mathbb{R}) \\ \uparrow & & \uparrow \\ \Omega_{\text{si}}^\bullet(U \times \Delta^k) & \xleftarrow{} & 0 \end{array} \right\}
\end{array}$$

hence a corresponding pullback diagram of simplicial presheaves, that we claim is a presentation for the defining double ∞ -pullback for *curv*.

The bottom square is the one we already discussed for the de Rham coefficients. Since the top right vertical morphism is a fibration, also the top square is a homotopy pullback and hence exhibits the defining ∞ -pullback for *curv*. \square

Corollary 4.4.81. *The degreewise map*

$$(-1)^{\bullet+1} \int_{\Delta^\bullet} : \mathbf{B}^n \mathbb{R}_{\text{diff, smp}} \rightarrow \mathbf{B}^n \mathbb{R}_{\text{diff, chn}}$$

that sends an n -form $A \in \Omega^n(U \times \Delta^k)$ and its curvature dA to $(-1)^{k+1}$ times its fiber integration $(\int_{\Delta^k} A, \int_{\Delta^k} dA)$ is a weak equivalence in $[\text{CartSp}_{\text{smooth}}^{\text{op}}, \text{sSet}]_{\text{proj}}$.

Proof. Since under homotopy pullbacks a weak equivalence of diagrams is sent to a weak equivalence. See the analogous argument in the proof of prop. 4.4.71. \square

4.4.15.3 Canonical form on a simplicial Lie group Above we discussed the canonical differential form on smooth ∞ -groups G for the special cases where G is a Lie group and where G is a circle Lie n -group. These are both in turn special cases of the situation where G is a *simplicial Lie group*. This we discuss now.

Proposition 4.4.82. *For G a simplicial Lie group the flat de Rham coefficient object $\mathbf{b}_{\text{dR}} \mathbf{B}G$ is presented by the simplicial presheaf which in degree k is given by $\Omega_{\text{flat}}^1(-, \mathfrak{g}_k)$, where $\mathfrak{g}_k = \text{Lie}(G_k)$ is the Lie algebra of G_k .*

Proof. Let

$$\Omega_{\text{flat}}^1(-, \mathfrak{g}_\bullet) // G_\bullet = \left(\Omega_{\text{flat}}^1(-, \mathfrak{g}_\bullet) \times C^\infty(-, G_\bullet) \rightrightarrows \Omega_{\text{flat}}^1(-, \mathfrak{g}_\bullet) \right)$$

be the presheaf of simplicial groupoids which in degree k is the groupoid of Lie-algebra valued forms with values in G_k from theorem. 1.2.107. As in the proof of prop. 4.4.47 we have that under the degreewise nerve this is a degreewise fibrant resolution of presheaves of bisimplicial sets

$$N(\Omega_{\text{flat}}^1(-, \mathfrak{g}_\bullet) // G_\bullet) \rightarrow N * // G_\bullet = NB(G_{\text{disc}})_\bullet$$

of the standard presentation of the delooping of the discrete group underlying G . By basic properties of bisimplicial sets [GoJa99] we know that under taking the diagonal

$$\text{diag} : \text{sSet}^\Delta \rightarrow \text{sSet}$$

the object on the right is a presentation for $\mathfrak{b}_{\text{dR}}\mathbf{BG}$, because (see the discussion of simplicial groups around prop. 3.6.131)

$$\text{diag} NB(G_{\text{disc}})_\bullet \xrightarrow{\cong} \bar{W}(G_{\text{disc}}) \simeq \mathfrak{b}\mathbf{BG}.$$

Now observe that the morphism

$$\text{diag}(N\Omega_{\text{flat}}^1(-, \mathfrak{g}_\bullet) // G_\bullet) \rightarrow \text{diag} N * // G_{\text{disc}}$$

is a fibration in the global model structure. This is in fact true for every morphism of the form

$$\text{diag} N(S_\bullet // G_\bullet) \rightarrow \text{diag} * // G_\bullet$$

for $S_\bullet // G_\bullet \rightarrow * // G_\bullet$ a simplicial action groupoid projection with G a simplicial group acting on a Kan complex S : we have that

$$(\text{diag} N(S // G))_k = S_k \times (G_k)^{\times k}.$$

On the second factor the horn filling condition is simply that of the identity map $\text{diag} NBG \rightarrow \text{diag} NBG$ which is evidently solvable, whereas on the first factor it amounts to $S \rightarrow *$ being a Kan fibration, hence to S being Kan fibrant.

But the simplicial presheaf $\Omega_{\text{flat}}^1(-, \mathfrak{g}_\bullet)$ is indeed Kan fibrant: for a given $U \in \text{CartSp}$ we may use parallel transport to (non-canonically) identify

$$\Omega_{\text{flat}}^1(U, \mathfrak{g}_k) \simeq \text{SmoothMfd}_*(U, G_k),$$

where on the right we have smooth functions that send the origin of U to the neutral element. But since G_\bullet is Kan fibrant and has smooth global fillers also $\text{SmoothMfd}_*(U, G_\bullet)$ is Kan fibrant.

In summary this means that the defining homotopy pullback

$$\mathfrak{b}_{\text{dR}}\mathbf{BG} := \mathfrak{b}\mathbf{BG} \times_{\mathbf{BG}} *$$

is presented by the ordinary pullback of simplicial presheaves

$$\text{diag} N\Omega_{\text{flat}}^1(-, \mathfrak{g}_\bullet) \times \text{diag} NBG_\bullet * = \Omega^1(-, \mathfrak{g}_\bullet).$$

□

Proposition 4.4.83. *For G a simplicial Lie group the canonical differential form, def. 3.9.29,*

$$\theta : G \rightarrow \mathfrak{b}_{\text{dR}}\mathbf{BG}$$

is presented in terms of the above presentation for $\mathfrak{b}_{\text{dR}}\mathbf{BG}$ by the morphism of simplicial presheaves

$$\theta_\bullet : G_\bullet \rightarrow \Omega_{\text{flat}}^1(-, \mathfrak{g}_\bullet)$$

which is in degree k the presheaf-incarnation of the Maurer-Cartan form of the ordinary Lie group G_k as in prop. 4.4.72.

Proof. Continuing with the strategy of the previous proof we find a fibration resolution of the point inclusion $* \rightarrow \mathfrak{b}\mathbf{B}G$ by applying the construction of the proof of prop. 4.4.72 degreewise and then applying $\text{diag} \circ N$.

The defining homotopy pullback

$$\begin{array}{ccc} G & \longrightarrow & * \\ \downarrow & & \downarrow \\ \mathfrak{b}_{dR} & \longrightarrow & \mathfrak{b}\mathbf{B}G \end{array}$$

for θ is this way presented by the ordinary pullback

$$\begin{array}{ccc} G_{\bullet} & \longrightarrow & \text{diag}N(\Omega_{\text{flat}}^1(-, \mathfrak{g}_{\bullet}))_{\text{triv}}//G_{\bullet} \\ \downarrow & & \downarrow \\ \Omega_{\text{flat}}^1(-, \mathfrak{g}_{\bullet}) & \longrightarrow & \text{diag}N(\Omega_{\text{flat}}^1(-, \mathfrak{g}_{\bullet})//G_{\bullet}) \end{array}$$

of simplicial presheaves, where $\Omega_{\text{flat}}^1(-, \mathfrak{g}_k)$ is the set of flat \mathfrak{g} -valued forms A equipped with a gauge transformation $0 \xrightarrow{g} A$. As in the above proof one finds that the right vertical morphism is a fibration, hence indeed a resolution of the point inclusion. The pullback is degreewise that from the case of ordinary Lie groups and thus the result follows. \square

We can now give a simplicial description of the canonical curvature form $\theta : \mathbf{B}^n U(1) \rightarrow \mathfrak{b}_{dR}\mathbf{B}^{n+1}U(1)$ that above in prop. 4.4.74 we obtained by a chain complex model:

Example 4.4.84. The canonical form on the circle Lie n -group

$$\theta : \mathbf{B}^{n-1}U(1) \rightarrow \mathfrak{b}_{dR}\mathbf{B}^n U(1)$$

is presented by the simplicial map

$$\Xi(U(1)[n-1]) \rightarrow \Xi(\Omega_{cl}^1(-)[n-1])$$

which is simply the Maurer-Cartan form on $U(1)$ in degree n .

The equivalence to the model we obtained before is given by noticing the equivalence in hypercohomology of chain complexes of abelian sheaves

$$\Omega_{cl}^1(-)[n] \simeq (\Omega^1(-) \xrightarrow{d_{dR}} \dots \xrightarrow{d_{dR}} \Omega_{cl}^n(-))$$

on CartSp .

4.4.16 Differential cohomology

We discuss the intrinsic differential cohomology, defined in 3.9.6 for any cohesive ∞ -topos, realized in the context $\text{Smooth}\infty\text{Grpd}$, with coefficients in the circle Lie $(n+1)$ -group $\mathbf{B}^n U(1)$, def. 4.4.21.

We show that here the general concept reproduces the Deligne-Beilinson complex, 1.2.131, and generalizes it to a complex for equivariant differential cohomology for ordinary and twisted notions of equivariance.

- 4.4.16.1 – The n -groupoid of circle-principal n -connections;
- 4.4.16.2 – The universal moduli n -stack of circle-principal n -connections;
- 4.4.16.4 – Equivariant circle n -bundles with connection;

The discussion here proceeds in the un-stabilized cohesive ∞ -topos $\text{Smooth}\infty\text{Grpd}$. By embedding this into its tangent cohesive ∞ -topos $T\text{Smooth}\infty\text{Grpd}$, def. 4.1.8, one obtains the characteristic curvature long exact sequences discussed below from the general abstract discussion of prop. 4.1.2.2

4.4.16.1 The smooth n -groupoid of circle-principal n -connections Here we discuss some basic facts about differential cohomology with coefficients in the circle n -group, def. 4.3.48, that are independent of a notion of manifolds and global differential form objects as in 3.9.6.2. Further below in 4.4.16.2 we do consider these structures and show that $\mathbf{B}^n U(1)_{\text{conn}}$ is presented by the Deligne complex.

Here we discuss first that intrinsic differential cohomology in $\text{Smooth}\infty\text{Grpd}$ has the abstract properties of traditional ordinary differential cohomology, [HoSi05], then we establish that both notions indeed coincide in cohomology. The intrinsic definition refines this ordinary differential cohomology to moduli ∞ -stacks.

By def. 3.9.37 we are to consider the ∞ -pullback

$$\begin{array}{ccc} \mathbf{H}_{\text{diff}}(X, \mathbf{B}^n U(1)) & \longrightarrow & H_{\text{dR}}(X, \mathbf{B}^{n+1} U(1)) , \\ \downarrow & & \downarrow \\ \mathbf{H}(X, \mathbf{B}^n U(1)) & \xrightarrow{\text{curv}} & \mathbf{H}_{\text{dR}}(X, \mathbf{B}^{n+1} U(1)) \end{array}$$

where the right vertical morphism picks one point in each connected component. Moreover, using prop. 4.4.49 in def. 3.9.42, we are entitled to the following bigger object.

Definition 4.4.85. For $n \in \mathbb{N}$ write $\mathbf{B}^n U(1)_{\text{conn}}$ for the ∞ -pullback

$$\begin{array}{ccc} \mathbf{B}^n U(1)_{\text{conn}} & \longrightarrow & \Omega_{\text{cl}}^{n+1}(-) \\ \downarrow & & \downarrow \\ \mathbf{B}^n U(1) & \xrightarrow{\text{curv}} & {}_b\text{dR}\mathbf{B}^{n+1} U(1) \end{array}$$

in $\text{Smooth}\infty\text{Grpd}$. The cocycle ∞ -groupoid over some $X \in \text{Smooth}\infty\text{Grpd}$ with coefficients in $\mathbf{B}^n U(1)_{\text{conn}}$ is the ∞ -pullback

$$\begin{array}{ccc} \mathbf{H}(X, \mathbf{B}^n U(1)_{\text{conn}}) & \simeq & \mathbf{H}'_{\text{diff}}(X, \mathbf{B}^n U(1)) \xrightarrow{F} \Omega_{\text{cl}}^{n+1}(X) \\ & & \downarrow \text{c} \qquad \qquad \qquad \downarrow \\ & & \mathbf{H}(X, \mathbf{B}^n U(1)) \xrightarrow{\text{curv}} \mathbf{H}_{\text{dR}}(X, \mathbf{B}^{n+1} U(1)) \end{array} .$$

We call $\mathbf{H}_{\text{diff}}(X, \mathbf{B}^n U(1))$ and its primed version the cocycle ∞ -groupoid for *ordinary smooth differential cohomology* in degree n .

Proposition 4.4.86. For $n \geq 1$ and $X \in \text{SmoothMfd}$, the abelian group $H'^n_{\text{diff}}(X)$ sits in the following short exact sequences of abelian groups

- the curvature exact sequence

$$0 \rightarrow H^n(X, U(1)_{\text{disc}}) \rightarrow H'^n_{\text{diff}}(X, U(1)) \xrightarrow{F} \Omega_{\text{cl, int}}^{n+1}(X) \rightarrow 0$$

- the characteristic class exact sequence

$$0 \rightarrow \Omega_{\text{cl}}^n / \Omega_{\text{cl, int}}^n(X) \rightarrow H'^n_{\text{diff}}(X, U(1)) \xrightarrow{\text{c}} H^{n+1}(X, \mathbb{Z}) \rightarrow 0 .$$

Here $\Omega_{\text{cl, int}}^n$ denotes closed forms with integral periods.

Proof. For the curvature exact sequence we invoke prop. 3.9.40, which yields (for H_{diff} as for H'_{diff})

$$0 \rightarrow H_{\text{flat}}^n(X, U(1)) \rightarrow H_{\text{diff}}^n(X, U(1)) \xrightarrow{F} \Omega_{\text{cl, int}}^{n+1}(X) \rightarrow 0.$$

The claim then follows by using prop. 4.4.43 to get $H_{\text{flat}}^n(X, U(1)) \simeq H^n(X, U(1)_{\text{disc}})$.

For the characteristic class exact sequence, we have with 3.9.41 for the smaller group H_{diff}^n (the fiber over the vanishing curvature $(n+1)$ -form $F=0$) the sequence

$$0 \rightarrow H_{\text{dR}}^n(X)/\Omega_{\text{cl, int}}^n(X) \rightarrow H_{\text{diff}}^n(X, U(1)) \xrightarrow{c} H^{n+1}(X, \mathbb{Z}) \rightarrow 0$$

where we used prop. 4.4.50 to identify the de Rham cohomology on the left, and the fact that X is paracompact to identify the integral cohomology on the right. Since $\Omega_{\text{cl, int}}^n(X)$ contains the exact forms (with all periods being $0 \in \mathbb{Z}$), the leftmost term is equivalently $\Omega_{\text{cl}}^n(X)/\Omega_{\text{cl, int}}^n(X)$. As we pass from H_{diff} to the bigger H'_{diff} , we get a copy of a torsor over this group, for each closed form F , trivial in de Rham cohomology, to a total of

$$\coprod_{F \in \Omega_{\text{cl}}^{n+1}(X)} \{\omega | d\omega = F\} / \Omega_{\text{cl, int}}^n \simeq \Omega^n(X) / \Omega_{\text{cl, int}}^n(X).$$

This yields the curvature exact sequence as claimed. \square

If we invoke standard facts about Deligne cohomology, then prop. 4.4.86 is also implied by the following proposition, which asserts that in $\text{Smooth}\infty\text{Grpd}$ the groups H'_{diff}^\bullet not only share the above abstract properties of ordinary differential cohomology, but indeed coincide with it.

Theorem 4.4.87. *For $X \in \text{SmoothMfd} \hookrightarrow \text{Smooth}\infty\text{Grpd}$ a paracompact smooth manifold we have that the connected components of the object $\mathbf{H}_{\text{diff}}(X, \mathbf{B}^n U(1))$ are given by*

$$H_{\text{diff}}^n(X, U(1)) \simeq (H(X, \mathbb{Z}(n+1)_D^\infty)) \times_{\Omega_{\text{cl}}^{n+1}(X)} H_{\text{dR, int}}^{n+1}(X).$$

Here on the right we have the subset of Deligne cocycles that picks for each integral de Rham cohomology class of X only one curvature form representative.

For the connected components of $\mathbf{H}'_{\text{diff}}(X, \mathbf{B}^n U(1))$ we get the complete ordinary Deligne cohomology of X in degree $n+1$:

$$H_{\text{diff}}^n(X, U(1)) \simeq H(X, \mathbb{Z}(n+1)_D^\infty)$$

Proof. Choose a differentiably good open cover, def. 4.4.2, $\{U_i \rightarrow X\}$ and let $C(\{U_i\}) \rightarrow X$ in $[\text{CartSp}^{\text{op}}, \text{sSet}]_{\text{proj}}$ be the corresponding Čech nerve projection, a cofibrant resolution of X .

Since the presentation of prop. 4.4.74 for the universal curvature class $\text{curv}_{\text{chn}} : \mathbf{B}^n U(1)_{\text{diff, chn}} \rightarrow \mathfrak{b}_{\text{dR}} \mathbf{B}^{n+1} U(1)_{\text{chn}}$ is a global fibration and $C(\{U_i\})$ is cofibrant, also

$$[\text{Cartp}^{\text{op}}, \text{sSet}](C(\{U_i\}), \mathbf{B}_{\text{diff}}^n U(1)) \rightarrow [\text{Cartp}^{\text{op}}, \text{sSet}](C(\{U_i\}), \mathfrak{b}_{\text{dR}} \mathbf{B}^n U(1))$$

is a Kan fibration by the fact that $[\text{CartSp}^{\text{op}}, \text{sSet}]_{\text{proj}}$ is an $\text{sSet}_{\text{Quillen}}$ -enriched model category. Therefore the homotopy pullback in question is computed as the ordinary pullback of this morphism.

By prop. 4.4.49 we can assume that the morphism $H_{\text{dR}}^{n+1}(X) \rightarrow [\text{CartSp}^{\text{op}}, \text{sSet}](C(\{U_i\}), \mathfrak{b}_{\text{dR}} \mathbf{B}^{n+1})$ picks only cocycles represented by globally defined closed differential forms $F \in \Omega_{\text{cl}}^{n+1}(X)$. We see that the elements in the fiber over such a globally defined $(n+1)$ -form F are precisely the cocycles with values only in the upper row complex of $\mathbf{B}^n U(1)_{\text{diff, chn}}$

$$C^\infty(-, U(1)) \xrightarrow{d_{\text{dR}}} \Omega^1(-) \xrightarrow{d_{\text{dR}}} \dots \xrightarrow{d_{\text{dR}}} \Omega^n(-),$$

such that F is the de Rham differential of the last term. This is the Deligne-Beilinson complex, def. 1.2.131, for Deligne cohomology in degree $(n+1)$. \square

In terms of def. 3.9.42 we have the object $\mathbf{B}^n U(1)_{\text{conn}}$ – the *moduli n -stack of circle n -bundles with connection* – which presents $\mathbf{H}'_{\text{diff}}(-, \mathbf{B}^n U(1))$

$$\mathbf{H}'_{\text{diff}}(-, \mathbf{B}^n U(1)) \simeq \mathbf{H}(-, \mathbf{B}^n U(1)_{\text{conn}}).$$

4.4.16.2 The universal moduli n -stack of circle-principal n -connections

Definition 4.4.88. For $n \in \mathbb{N}$ and $k \leq n$ write

$$\Omega_{\text{cl}}^{k \leq \bullet \leq n} := \text{DK} \left(\Omega^k \xrightarrow{d_{\text{dR}}} \Omega^{k+1} \longrightarrow \dots \xrightarrow{d_{\text{dR}}} \Omega^{n-1} \xrightarrow{d_{\text{dR}}} \Omega_{\text{cl}}^n \right).$$

Write

$$\mathbf{B}^n U(1)_{\text{conn}^k, \text{chn}} := \text{DK} \left(U(1)\Omega^1 \xrightarrow{d_{\text{dR}}} \dots \xrightarrow{d_{\text{dR}}} \Omega^k \longrightarrow 0 \longrightarrow \dots \longrightarrow 0 \right)$$

for the simplicial presheaf which is the image under the Dold-Kan map of the chain complex concentrated in degrees n through $(n - k)$, as indicated. Notice that

$$\mathbf{B}^n U(1)_{\text{conn}^0, \text{chn}} = \mathbf{B}^n U(1)_{\text{chn}},$$

and we write

$$\mathbf{B}^n U(1)_{\text{conn}, \text{chn}} := \mathbf{B}^n U(1)_{\text{conn}^n, \text{chn}}.$$

Proposition 4.4.89. The object $\mathbf{B}^n U(1)_{\text{conn}}^k \in \text{Smooth}\infty\text{Grpd}$ is presented in $[\text{CartSp}^{\text{op}}, \text{sSet}]_{\text{proj}, \text{loc}}$ by $\mathbf{B}^n U(1)_{\text{conn}^k, \text{chn}}$.

Proof. By prop. 4.4.74 the defining ∞ -pullback

$$\begin{array}{ccc} \mathbf{B}^n U(1)_{\text{conn}^k} & \xrightarrow{F(-)} & \Omega_{\text{cl}}^{k \leq \bullet \leq n} \\ \downarrow & & \downarrow \\ \mathbf{B}^n U(1) & \xrightarrow{\text{curv}} & \mathfrak{b}_{\text{dR}} \mathbf{B}^{n+1} U(1) \end{array}$$

is presented by the homotopy pullback of presheaves of chain complexes

$$\begin{array}{ccc} \mathbf{B}^n U(1)_{\text{diff}, \text{chn}} & \longleftarrow & \mathbf{B}^n U(1)_{\text{conn}^k, \text{chn}} \\ \downarrow \text{curv}_{\text{chn}} & & \downarrow \\ \mathfrak{b}_{\text{dR}} \mathbf{B}^{n+1} U(1)_{\text{chn}} & \longleftarrow & \Omega_{\text{cl}}^{k \leq \bullet \leq n} \end{array}$$

(rotated here just for readability in the following) which in components is given as follows

$$\begin{array}{ccccccc} U(1) & \xrightarrow{d_{\text{dR}}} \dots \xrightarrow{d_{\text{dR}}} & \Omega^1 & \longrightarrow \dots & \Omega^{n-1} & \xrightarrow{d_{\text{dR}}} & \Omega^n \\ \oplus & & \oplus & & \oplus & \xrightarrow{(-1)^n \text{id}} & \oplus \\ \Omega^1 & \xrightarrow{d_{\text{dR}}} \dots \xrightarrow{d_{\text{dR}}} & \Omega^k & \longrightarrow \dots & \Omega^n & & \Omega^n \\ \downarrow (-1)^n \text{id} & & \downarrow (-1)^n \text{id} & & \downarrow (-1)^n \text{id} & & \downarrow (-1)^n \text{id} \\ \Omega^1 & \xrightarrow{d_{\text{dR}}} \dots \xrightarrow{d_{\text{dR}}} & \Omega^{k+1} & \longrightarrow \dots & \Omega^n & \xrightarrow{d_{\text{dR}}} & \Omega_{\text{cl}}^{n+1} \\ & & & & & & \downarrow d_{\text{dR}} \\ & & & & & & \Omega_{\text{cl}}^{n+1} \end{array}$$

This shows that $\mathbf{B}^n U(1)_{\text{conn}^k}$ is presented by the chain complex appearing on the top right here. The canonical projection morphism from this pullback to $\mathbf{B}^n U(1)_{\text{conn}^k, \text{chn}}$ is clearly a weak equivalence. \square

Remark 4.4.90. In particular this means that $\mathbf{B}^n U(1)_{\text{conn}}$ is presented by the Deligne complex

$$\mathbf{B}^n U(1)_{\text{conn}} \simeq \text{DK} \left(U(1) \xrightarrow{d_{\text{dR}}} \Omega^1 \xrightarrow{d_{\text{dR}}} \dots \longrightarrow \Omega^{n-1} \xrightarrow{d_{\text{dR}}} \Omega^n \right)$$

The above proof of theorem 4.4.87 makes a statement not only about cohomology classes, but about the full moduli n -stacks:

Proposition 4.4.91. *The object $\mathbf{B}^n U(1)_{\text{conn}} \in \mathbf{H}$ from def. 4.4.85 is presented by the simplicial presheaf which is the image under the Dold-Kan map Ξ , def. 2.2.31, of the Deligne complex in the corresponding degree.*

The canonical morphism $\mathbf{B}^n U(1)_{\text{conn}} \rightarrow \mathbf{B}^n U(1)$ is similarly presented via Dold-Kan of the evident morphism of chain complexes of sheaves

$$\begin{array}{ccccccc} C^\infty(-, U(1)) & \xrightarrow{d_{\text{dR}} \log} & \Omega^1(-) & \xrightarrow{d_{\text{dR}}} & \dots & \xrightarrow{d_{\text{dR}}} & \Omega^n(-) \\ \downarrow \text{id} & & \downarrow & & & & \downarrow \\ C^\infty(-, U(1)) & \longrightarrow & 0 & \longrightarrow & \dots & \longrightarrow & 0 \end{array} .$$

Proposition 4.4.92. *The moduli stack $\mathbf{BU}(1)_{\text{conn}}$ of circle bundles (i.e. circle 1-bundles) with connection is 1-concrete, def. 3.7.7.*

Proof. Observing that the presentation by the Deligne complex under the Dold-Kan map is fibrant in $[\text{CartSp}^{\text{op}}, \text{sSet}]_{\text{proj, loc}}$ and is the concrete sheaf presented by $U(1)$ in degree 1, this follows with prop. 3.7.8. \square

4.4.16.3 The smooth moduli of connections over a given base We discuss the *moduli stacks* of higher principal connections, over a fixed $X \in \text{Smooth}\infty\text{Grpd}$, following the general abstract discussion in 3.9.6.4.

For $n \in \mathbb{N}$ and with $\mathbf{B}^n U(1)_{\text{conn}} \in \text{Smooth}\infty\text{Grpd}$ the universal moduli stack for circle n -bundles with connection, def. 4.4.73, and for $X \in \text{Smooth}\infty\text{Grpd}$, one may be tempted to regard the internal hom/mapping space $[X, \mathbf{B}^n U(1)_{\text{conn}}]$ as the moduli stack of circle n -bundles with connection on X . However, for $U \in \text{CartSp}$ an abstract coordinate system, U -plots and their k -morphisms in $[X, \mathbf{B}^n U(1)_{\text{conn}}]$ are circle principal n -connections and their k -fold gauge transformations on $U \times X$, and this is not generally what one would want the U -plots of the moduli stack of such connections on X to be. Rather, that moduli stack should have

1. as U -plots smoothly U -parameterized collections $\{\nabla_u\}$ of n -connections on X ;
2. as k -morphisms smoothly U -parameterized collections $\{\phi_u\}$ of gauge transformations between them.

The first item is equivalent to: a single n -connection on $U \times X$ such that its local connection n -forms have no legs along U . This is essentially the situation of moduli of differential forms which we have discussed above (...).

But the second item is different: a gauge transformation of a single n -connection ∇ on $U \times X$ needs to respect the curvature of the connection along U , but a family $\{\phi_u\}$ of gauge transformations between the restrictions $\nabla|_u$ of ∇ to points of the coordinate patch U need not.

In order to capture this correctly, the concretification-process that yields the moduli spaces of differential forms is to be refined to a process that concretifies the higher stack $[X, \mathbf{B}^n U(1)_{\text{conn}}]$ degreewise in stages.

Definition 4.4.93. For $n, k \in \mathbb{N}$ and $k \leq n$ write $\mathbf{B}^n U(1)_{\text{conn}^k}$ for the ∞ -pullback in

$$\begin{array}{ccc} \mathbf{B}^n U(1)_{\text{conn}^k} & \longrightarrow & \Omega_{\text{cl}}^{n+1 \leq \bullet \leq k} \\ \downarrow & & \downarrow \\ \mathbf{B}^n U(1) & \xrightarrow{\text{curv}} & b_{\text{dR}} \mathbf{B}^{n+1} U(1) \end{array} .$$

By the universal property of the ∞ -pullback, the canonical tower of morphisms

$$\Omega_{\text{cl}}^{n+1} \longrightarrow \Omega_{\text{cl}}^{n+1 \leq \bullet \leq n} \longrightarrow \dots \longrightarrow \Omega_{\text{cl}}^{n+1 \leq \bullet \leq 1} \xrightarrow{\cong} b_{\text{dR}} \mathbf{B}^{n+1} U(1)$$

induces a tower of morphisms

$$\mathbf{B}^n U(1)_{\text{conn}} \xrightarrow{\cong} \mathbf{B}^n U(1)_{\text{conn}^n} \longrightarrow \mathbf{B}^n U(1)_{\text{conn}^{n-1}} \longrightarrow \dots \longrightarrow \mathbf{B}^n U(1)_{\text{conn}^0} \xrightarrow{\cong} \mathbf{B}^n U(1) .$$

Proposition 4.4.94. *We have*

$$\mathbf{B}^n U(1)_{\text{conn}^k} \simeq \text{DK} \left(U(1) \xrightarrow{d_{\text{dR}}} \Omega^1 \xrightarrow{d_{\text{dR}}} \dots \xrightarrow{d_{\text{dR}}} \Omega^k \xrightarrow{d_{\text{dR}}} 0 \longrightarrow \dots \longrightarrow 0 \right)$$

where the chain complex on the right is concentrated in degrees n through $n - k$. Under this equivalence the canonical morphism $\mathbf{B}^n U(1)_{\text{conn}^{k+1}} \rightarrow \mathbf{B}^n U(1)_{\text{conn}^k}$ is equivalent to the image under DK to the chain map

$$\begin{array}{cccccccccccc} U(1) & \xrightarrow{d_{\text{dR}}} & \Omega^1 & \xrightarrow{d_{\text{dR}}} & \dots & \xrightarrow{d_{\text{dR}}} & \Omega^{k+1} & \xrightarrow{d_{\text{dR}}} & \Omega^k & \longrightarrow & 0 & \longrightarrow & \dots & \longrightarrow & 0 \\ \downarrow \text{id} & & \downarrow \text{id} & & \downarrow \text{id} & & \downarrow \text{id} & & \downarrow & & \downarrow & & \downarrow & & \downarrow \\ U(1) & \xrightarrow{d_{\text{dR}}} & \Omega^1 & \xrightarrow{d_{\text{dR}}} & \dots & \xrightarrow{d_{\text{dR}}} & \Omega^{k+1} & \xrightarrow{d_{\text{dR}}} & 0 & \longrightarrow & 0 & \longrightarrow & \dots & \longrightarrow & 0 \end{array}$$

Proof. By the presentation of curv as in prop. 4.4.74. □

Definition 4.4.95. For $X \in \mathbf{H}$ and $n \in \mathbb{N}$, $n \geq 1$, the *moduli of circle-principal n -connections* on X is the iterated ∞ -fiber product

$$\begin{aligned} & (\mathbf{B}^{n-1} U(1)) \text{Conn}(X) \\ & := \sharp_1[X, \mathbf{B}^n U(1)_{\text{conn}^n}] \times_{\sharp_1[X, \mathbf{B}^n U(1)_{\text{conn}^{n-1}}]} \sharp_2[X, \mathbf{B}^n U(1)_{\text{conn}^{n-1}}] \times_{\sharp_2[X, \mathbf{B}^n U(1)_{\text{conn}^{n-2}}]} \dots \times_{\sharp_n[X, \mathbf{B}^n U(1)_{\text{conn}^0}]} [X, \mathbf{B}^n U(1)_{\text{conn}^0}] , \end{aligned}$$

of the morphisms

$$\sharp_k[X, \mathbf{B}^n U(1)_{\text{conn}^{n-k+1}}] \longrightarrow \sharp_k[X, \mathbf{B}^n U(1)_{\text{conn}^{n-k}}]$$

which are the image under \sharp_k , def. 3.7.6, of the image under the internal hom $[X, -]$ of the canonical projections of prop. 4.4.93, and of the morphisms

$$\sharp_{k+1}[X, \mathbf{B}^n U(1)_{\text{conn}^{n-k}}] \longrightarrow \sharp_k[X, \mathbf{B}^n U(1)_{\text{conn}^{n-k}}]$$

of def. 3.7.6.

4.4.16.3.1 Moduli of smooth principal 1-connections We discuss the general notion of moduli of G -principal connections, def. 3.9.50 for the special case that G is a 0-truncated group.

For $G = U(1)$ the circle group, the special case of def. 4.4.95 is the following.

Definition 4.4.96. For $X \in \text{Smooth}\infty\text{Grpd}$, the *moduli of circle-principal connections* is given by the ∞ -pullback

$$\begin{array}{ccc} U(1)\mathbf{Conn}(X) & \longrightarrow & \sharp_2[X, \mathbf{BU}(1)] \simeq [X, \mathbf{BU}(1)] , \\ \downarrow & & \downarrow \\ \sharp_1[X, \mathbf{BU}(1)_{\text{conn}}] & \xrightarrow{\sharp_1[X, U_{\mathbf{BU}(1)}]} & \sharp_1[X, \mathbf{BU}(1)] \end{array}$$

where $U_{\mathbf{BU}(1)} : \mathbf{BU}(1)_{\text{conn}} \rightarrow \mathbf{BU}(1)$ is the canonical forgetful morphism.

Of course we have the analogous construction for G any Lie group:

Definition 4.4.97. For $X \in \text{Smooth}\infty\text{Grpd}$, the *moduli of circle-principal connections* is given by the ∞ -pullback

$$\begin{array}{ccc} G\mathbf{Conn}(X) & \longrightarrow & \sharp_2[X, \mathbf{BG}] \simeq [X, \mathbf{BG}] , \\ \downarrow & & \downarrow \\ \sharp_1[X, \mathbf{BG}_{\text{conn}}] & \xrightarrow{\sharp_1[X, U_{\mathbf{BG}}]} & \sharp_1[X, \mathbf{BG}] \end{array}$$

where $U_{\mathbf{BG}} : \mathbf{BG}_{\text{conn}} \rightarrow \mathbf{BG}$ is the canonical forgetful morphism.

Proposition 4.4.98. For $X \in \text{SmthMfd} \leftrightarrow \text{Smooth}\infty\text{Grpd}$, the smooth groupoid $U(1)\mathbf{Conn}(X)$ of def. 4.4.96 is indeed the smooth moduli object/moduli stack of circle-principal connections on X ; in that its U -plots of are smoothly U -parameterized collections of smooth circle-principal connections on X and its morphisms of U -plots are smoothly U -parameterized collections of smooth gauge transformation between these, on X .

Proof.

By the discussion of n -image and using arguments as for the concretification of moduli of differential forms above, we have:

- $\sharp_1[X, \mathbf{BU}(1)_{\text{conn}}]$ has as U -plots smoothly U -parameterized $U(1)$ -principal connections on X that have a lift to a $U(1)$ -principal connection on $U \times X$, and morphisms are discretely $\Gamma(U)$ -parameterized collections of gauge transformations of these connections on X .
- $\sharp_1[X, \mathbf{BU}(1)]$ looks similarly, just without the connection information;
- $\sharp_1[X, U_{\mathbf{BU}(1)_{\text{conn}}}]$ simply forgets the connection data on the collections of bundles-with-connection; the point to notice is that oveach each chart U it is a fibration(isofibration): given a $\Gamma(U)$ -parameterized collection of gauge transformations out of a smoothly U -parameterized collection of bundles and then a smooth choice of smooth connections on these bundles, the $\Gamma(U)$ collection of gauge transformations of course also acts on these connections;
- $\sharp_2[X, \mathbf{BU}(1)] \simeq [X, \mathbf{BU}(1)]$ (because if two gauge transformations of bundles on $U \times X$ coincide on each point of U as gauge tranformations on X , then they were already equal).

From the third item it follows that we may compute equivalently simply the pullback in the 1-category of groupoid-valued presheaves on CartSp . This means that a U -plot of the pullback is a smoothly U -parameterized collection $\{\nabla_u\}$ of $U(1)$ -principal connections on X which admits a lift to a $U(1)$ -principal connection on $U \times X$, and that a morphism between such as a $\Gamma(U)$ -parameterized collection of gauge transformations $\{\phi_u\}$ of connections, such that their underlying collection of gauge transformations of bundles is a smoothly U -parameterized family. But gauge transformations of 1-connections are entirely determined

by the underlying gauge transformation of the underlying bundle, and so this just means that also the morphism of U -plots of the pullback are smoothly U -parameterized collections of gauge transformations.

Consider then the functor from $U(1)\mathbf{Conn}(X)_U$ to this pullback which forgets the lift to a connection on $U \times X$. This is natural in U and hence to complete the proof we need to see that for each U it is an equivalence of groupoids. By the above it is clearly fully faithful, so it remains to see that it is essentially surjective, hence that every smoothly U -parameterized collection of connections on X comes from a single connection on $X \times U$. To this end, consider a smoothly U -parameterized collection $\{\nabla_u\}_{u \in U}$ of $U(1)$ -principal connections on X . Choosing a differentiably good open cover $\{U_i \rightarrow X\}$ of X the collection of connections is equivalently given by a collection of cocycle data

$$\{g_{ij}^u \in C^\infty(U_i \cap U_j, U(1)), A_i^u \in \Omega^1(U_i)\}_{u \in U}$$

with $A_j^u = A_i^u + d_X \log g_{ij}^u$ on $U_i \cap U_j$ for all i, j in the index set and all $u \in U$. To see that this is the restriction of a single such cocycle datum on $\{U_i \times U \rightarrow X \times U\}$ we use the standard formula for the existence of connections on a given bundle represented by a given cocycle, but applied just to the U -factor. So let $\{\rho_i \in C^\infty(U_i \times U)\}$ be a partition of unity on $X \times U$ subordinate to the chosen cover and define $A_i \in \Omega^1(U_i \times U)$ by

$$A_i(u) := A_i^u + \sum_{i_0} \rho_{i_0} d_U \log g_{i_0 i}(u)$$

for each $u \in U$. This is clearly a lift on each patch, and it does constitute a cocycle for a connection on $X \times U$ since on each $U \times (U_i \cap U_j)$ we have:

$$\begin{aligned} A_j(u) - A_i(u) &= \sum_{i_0} \rho_{i_0} (A_j^u + d_U \log g_{i_0 j}(u) - A_i^u - d_U \log g_{i_0 i}(u)) \\ &= A_j^u - A_i^u + \sum_{i_0} \rho_{i_0} d_U \log (g_{i_0 j}(u) g_{i_0 i}(u)) \\ &= d_X \log g_{ij}(u) + d_U \log g_{ji}(u) \\ &= d \log g_{ij}(u) \end{aligned}$$

□

Proposition 4.4.99. *For $G \in \text{Grp}(\text{Smth}\infty\text{Grp})$ a 0-truncated group object and for $X \in \text{Smth}\infty\text{Grpd}$, we have an equivalence*

$$\Omega(G\mathbf{Conn}(X)) \simeq G$$

in $\text{Smooth}\infty\text{Grpd}$, between the loop space object of the moduli object of G def. 4.4.97, and G itself.

Proof. For X a smooth manifold and G a Lie group, this is straightforward to check by inspection of the stack $\Omega(G\mathbf{Conn}(X))$. Its U -plots are the smoothly U -parameterized collections of gauge transformations of the trivial G -principal connection on X . Any such is a constant G -valued function on X , hence an element of G , and so these form the set $C^\infty(U, G)$ of U -plots of G .

Generally, the statement follows abstractly from prop. 3.6.47. By that proposition and using that Ω commutes over ∞ -fiber products (since both are ∞ -limits) we have

$$\begin{aligned} \Omega(G\mathbf{Conn}(X)) &\simeq \Omega_{\#1}[X, \mathbf{BG}_{\text{conn}}] \times_{\Omega_{\#1}[X, \mathbf{BG}]} \Omega[X, \mathbf{BG}] \\ &\simeq \# \Omega[X, \mathbf{BG}_{\text{conn}}] \times_{\# \Omega[X, \mathbf{BG}]} \Omega[X, \mathbf{BG}] \\ &\simeq \#[X, \Omega \mathbf{BG}_{\text{conn}}] \times_{\#[X, \Omega \mathbf{BG}]} [X, \Omega \mathbf{BG}] \\ &\simeq \#[X, \flat G] \times_{\#[X, G]} [X, G] \\ &\simeq \# G \times_{\#[X, G]} [X, G] \end{aligned}$$

This last ∞ -fiber product is one of 0-truncated object hence is the ordinary fiber products of the corresponding sheaves. The U -plots of the left factor are discretely $\Gamma(U)$ -parameterized collections of elements of G , the inclusion of these into $\sharp[X, G]$ is as $\Gamma(U)$ -parameterized collections of constant G -valued functions on G , and the right factor picks out among these those that are smoothly parameterized over $X \times U$, hence over U . This is the statement to be shown. \square

4.4.16.3.2 Moduli of smooth principal 2-connections We discuss the general notion of moduli of G -principal connections, def. 3.9.50 for the special case that G is a 1-truncated group.

Proposition 4.4.100. *Given $X \in \text{SmthMfd} \hookrightarrow \text{Smooth}\infty\text{Grpd}$, the moduli 2-stack $(\mathbf{BU}(1))\mathbf{Conn}(X)$ of circle 2-bundles with connection on X , given by the ∞ -limit in*

$$\begin{array}{ccc}
 (\mathbf{BU}(1))\mathbf{Conn}(X) & \longrightarrow & [X, \mathbf{B}^2U(1)] \\
 \downarrow & & \downarrow \\
 \sharp_1[X, \mathbf{B}^2U(1)_{\text{conn}}] & \longrightarrow & \sharp_1[X, \mathbf{B}^2U(1)_{\text{conn}^1}] \\
 & & \downarrow \\
 & & \sharp_2[X, \mathbf{B}^2U(1)_{\text{conn}^1}] \longrightarrow \sharp_2[X, \mathbf{B}^2U(1)]
 \end{array}$$

is equivalent to the 2-stack which assigns to any $U \in \text{CartSp}$ the 2-groupoid whose objects, morphisms, and 2-morphisms are smoothly U -parameterized collections of circle-principal connections and their gauge transformations on X .

Proof. By a variant of the pasting law, we may compute the given ∞ -limit as the pasting composite of three ∞ -pullbacks:

$$\begin{array}{ccccc}
 (\mathbf{BU}(1))\mathbf{Conn}(X) & \longrightarrow & & \longrightarrow & [X, \mathbf{B}^2U(1)] \\
 \downarrow & & \downarrow & & \downarrow \\
 & & \sharp_2[X, \mathbf{B}^2U(1)_{\text{conn}^1}] & \longrightarrow & \sharp_2[X, \mathbf{B}^2U(1)] \\
 \downarrow & \longrightarrow & \downarrow & & \\
 \sharp_1[X, \mathbf{B}^2U(1)_{\text{conn}}] & \longrightarrow & \sharp_1[X, \mathbf{B}^2U(1)_{\text{conn}^1}] & &
 \end{array}$$

Since this is a finite ∞ -limit, we may compute it in ∞ -presheaves over CartSp , hence as a homotopy pullback in $[\text{CartSp}^{\text{op}}, \text{sSet}]_{\text{proj}}$. For $\{U_i \rightarrow X\}_{i \in I}$ any choice of differentiable good open cover of X , our standard model for the mapping stacks appearing in the diagram are given by the Deligne complex, according to prop. 4.4.91. Since this takes values, under the Dold-Kan map, in strict ∞ -groupoids, we find the \sharp -images by prop. 3.6.53. In this standard presentation all simplicial presheaves appearing in the diagram are fibrant and the two horizontal morphisms are fibrations. Therefore we conclude that the ∞ -limit in question is in fact given by the pasting composite of three 1-categorical pullbacks of these presheaves of strict 2-groupoids. Using that pullbacks of presheaves of 2-groupoids are computed objectwise and degreewise, we find that the pullback presheaf is over $U \in \text{CartSp}$ given by the following strict 2-groupoid:

- objects are smoothly U -parameterized collections of Deligne cocycles $\{B_i^u, A_{ij}^u, g_{ijk}^u\}_{i,j,k \in I, u \in \Gamma(U)}$ on X , such that there *exists* a lift to a single cocycle on $X \times U$ (this is the structure of the objects of $\sharp_1[X, \mathbf{B}^2U(1)_{\text{conn}}]$) and *equipped* with a choice of lift of the restricted $\mathbf{BU}(1)_{\text{conn}^1}$ -cocycle $\{0, A_{ij}^u, g_{ijk}^u\}_{u \in U}$ to a single restricted cocycle $\{0, A_{ij}, g_{ijk}\}$ on $U \times X$ (this is the structure of the objects of $\sharp_2[X, \mathbf{B}^2U(1)_{\text{conn}^1}]$);

- morphisms are smoothly U -parameterized collections of morphisms of cocycles on X such that there exists a lift to a morphism of restricted cocycles on $X \times U$;
- 2-morphisms are smoothly U -parameterized collections of 2-gauge transformations, hence 2-gauge transformations on $X \times U$.

This is almost verbatim the 2-groupoid claimed in the proposition, except for the appearance of the existence and choice of lifts. We need to show that up to equivalence these drop out.

Consider therefore the canonical 2-functor from the 2-groupoid thus described to the one consisting degreewise of genuine smoothly U -parameterized collections of cocycles and transformations, which forgets the lift and the existence of lifts. This 2-functor is clearly natural in U , hence is a morphism of simplicial presheaves. It is now sufficient to show that over each U this is an equivalence of 2-groupoids.

To see that this 2-functor is fully faithful, notice that by the strict abelian group structure on all objects we may restrict to considering the homotopy groups that are based at the 0-cocycle. But the automorphism groupoid of the trivial circle-principal 2-connection is that of flat circle-principal 1-connections. Hence fully faithfulness of this 2-functor amounts to the statement of prop. 4.4.98.

Therefore it remains to check essential surjectivity of the forgetful 2-functor. To this end, observe that the underlying circle-principal 2-bundles of a collection of 2-connections smoothly parameterized by a Cartesian (hence topologically contractible) space necessarily have the same class at all points $u \in U$ and so every object in the pullback 2-groupoid is equivalent to one for which $\{g_{ijk}^u\}$ is in fact independent of u . It is then sufficient to show that any such is in the image of the above forgetful 2-functor.

So consider a smoothly parameterized collection of Deligne cocycles on $\{U_i \rightarrow X\}_{i \in I}$ of the form $\{B_i^u, A_{ij}^u, g_{ijk}\}_{u \in U}$. Since now g_{ijk} is constant on U , we can obtain a lift of the 1-form part simply by defining for $i, j \in I$ a 1-form $A_{ij} \in \Omega^1(U \times (U_i \cap U_j))$ by declaring that at $u \in U$ it is given by

$$A_{ij}(u) := A_{ij}^u.$$

Next we need to similarly find a lift $\{B_i \in \Omega^2(U \times U_i)\}_{i \in I}$. For that, choose now a partition of unity $\{\rho_i \in C^\infty(U_i)\}_i$ of X , subordinate to the given cover and set

$$B_i(u) := B_i^u + \sum_{i_0} \rho_{i_0} d_U A_{i_0 i}(u).$$

This is clearly patchwise a lift and we check that it satisfies the cocycle condition by computing for each $i, j \in I, u \in U$:

$$\begin{aligned} B_j(u) - B_i(u) &= B_j^u - B_i^u + \sum_{i_0} \rho_{i_0} d_U (A_{i_0 j} - A_{i_0 i})(u) \\ &= d_X A_{ij}(u) + \sum_{i_0} \rho_{i_0} d_U (A_{ij} - d_X \log g_{i_0 ij})(u), \\ &= d_{U \times X} A_{ij} \end{aligned}$$

where in the second but last step we used that at each u the A_{ij}^u satisfy their cocycle condition and where in the last step we used again that g_{\dots} is constant on U on X .

So the 2-functor is also essentially surjective and this completes the proof. \square

4.4.16.4 Equivariant circle n -bundles with connection We highlight some aspects of the *equivariant* version, def. 3.6.136, of smooth differential cohomology.

Observation 4.4.101. Let G be a Lie group acting on a smooth manifold X . Then the Deligne complex, def. 1.2.131, computes the correct G -equivariant differential cohomology on X if and only if the G -equivariant de Rham cohomology of X , prop. 4.4.54, coincides with the G -invariant Rham cohomology of X .

Proof. By prop. 4.4.54 we have that the G -equivariant de Rham cohomology of X is given for $n \geq 1$ by

$$H_{\mathrm{dR},G}^{n+1}(X) \simeq \pi_0 \mathbf{H}(X//G, \mathfrak{b}_{\mathrm{dR}} \mathbf{B}^{n+1} \mathbb{R}).$$

Observe that $\pi_0 \mathbf{H}(X//G, \Omega_{\mathrm{cl}}^n(-))$ is set of G -invariant closed differential n -forms on X (which are in particular equivariant, but in general do not exhaust the equivariant cocycles). By prop. 4.4.87 the Deligne complex presents the homotopy pullback of $\Omega_{\mathrm{cl}}^{n+1}(-) \rightarrow \mathfrak{b}_{\mathrm{dR}} \mathbf{B}^{n+1} \mathbb{R}$ along the universal curvature map on $\mathbf{B}^n U(1)$. If therefore the inclusion $\pi_0 \mathbf{H}(X//G, \Omega_{\mathrm{cl}}^{n+1}(-)) \rightarrow \pi_0 \mathbf{H}(X//G, \mathfrak{b}_{\mathrm{dR}} \mathbf{B}^{n+1} \mathbb{R})$ of invariant into equivariant de Rham cocycles is not surjective, then there are differential cocycles on $X//G$ not presented by the Deligne complex. \square

In other words, if the G -invariant de Rham cocycles do not exhaust the equivariant cocycles, then $X//G$ is not *de Rham-projective*, and hence the representable variant, def. 3.9.42, of differential cohomology does not apply. The correct definition of differential cohomology in this case is the more general one from def. 3.9.37, which allows the curvature forms themselves to be in equivariant cohomology.

4.4.17 ∞ -Chern-Weil homomorphism

We discuss the general abstract notion of Chern-Weil homomorphism, 3.9.7, realized in $\mathrm{Smooth}\infty\mathrm{Grpd}$.

Recall that for $A \in \mathrm{Smooth}\infty\mathrm{Grpd}$ a smooth ∞ -groupoid regarded as a coefficient object for cohomology, for instance the delooping $A = \mathbf{B}G$ of an ∞ -group G we have general abstractly that

- a characteristic class on A with coefficients in the circle Lie n -group, 4.4.21, is represented by a morphism

$$\mathbf{c} : A \rightarrow \mathbf{B}^n U(1);$$

- the (unrefined) Chern-Weil homomorphism induced from this is the differential characteristic class given by the composite

$$\mathbf{c}_{\mathrm{dR}} : A \xrightarrow{\mathbf{c}} \mathbf{B}^n U(1) \xrightarrow{\mathrm{curv}} \mathfrak{b}_{\mathrm{dR}} \mathbf{B}^{n+1} \mathbb{R}$$

with the universal curvature characteristic, 3.9.5, on $\mathbf{B}^n U(1)$, or rather: is the morphism on cohomology

$$H_{\mathrm{Smooth}}^1(X, G) := \pi_0 \mathrm{Smooth}\infty\mathrm{Grpd}(X, \mathbf{B}G) \xrightarrow{\pi_0((\mathbf{c}_{\mathrm{dR}})_*)} \pi_0 \mathrm{Smooth}\infty\mathrm{Grpd}(X, \mathfrak{b}_{\mathrm{dR}} \mathbf{B}^{n+1} \mathbb{R}) \simeq H_{\mathrm{dR}}^{n+1}(X)$$

induced by this.

By prop. 4.4.79 we have a presentation of the universal curvature class $\mathbf{B}^n \mathbb{R} \rightarrow \mathfrak{b}_{\mathrm{dR}} \mathbf{B}^{n+1} \mathbb{R}$ by a span

$$\begin{array}{ccc} \mathbf{B}^n \mathbb{R}_{\mathrm{diff}, \mathrm{smp}} & \xrightarrow{\mathrm{curv}_{\mathrm{smp}}} & \mathfrak{b}_{\mathrm{dR}} \mathbf{B}^{n+1} \mathbb{R}_{\mathrm{smp}} \\ \downarrow \simeq & & \\ \mathbf{B}^n \mathbb{R}_{\mathrm{smp}} & & \end{array}$$

in the model structure on simplicial presheaves $[\mathrm{CartSp}_{\mathrm{smooth}}^{\mathrm{op}}, \mathrm{sSet}]_{\mathrm{proj}}$, given by maps of smooth families of differential forms. We now insert this in the above general abstract definition of the ∞ -Chern-Weil homomorphism to deduce a presentation of that in terms of smooth families L_∞ -algebra valued differential forms.

The main step is the construction of a well-suited composite of two spans of morphisms of simplicial presheaves (of two ∞ -anafunctors): we consider presentations of characteristic classes $\mathbf{c} : \mathbf{B}G \rightarrow \mathbf{B}^n U(1)$ in the image of the $\exp(-)$ map, def. 4.4.56, and presented by truncations and quotients of morphisms of simplicial presheaves of the form

$$\exp(\mathfrak{g}) \xrightarrow{\exp(\mu)} \exp(\mathfrak{b}^{n-1} \mathbb{R}).$$

Then, using the above, the composite differential characteristic class \mathbf{c}_{dR} is presented by the zig-zag

$$\begin{array}{ccc} & \mathbf{B}^n \mathbb{R}_{\text{diff, smp}} & \xrightarrow{\text{curv}_{\text{smp}}} \mathfrak{b}_{\text{dR}} \mathbf{B}^{n+1} \mathbb{R}_{\text{smp}} \\ & \downarrow \simeq & \\ \exp(\mathfrak{g}) & \xrightarrow{\exp(\mu)} & \mathbf{B}^n \mathbb{R}_{\text{smp}} \end{array}$$

of simplicial presheaves. In order to efficiently compute which morphism in $\text{Smooth}\infty\text{Grpd}$ this presents we need to construct, preferably naturally in the L_∞ -algebra \mathfrak{g} , a simplicial presheaf $\exp(\mathfrak{g})_{\text{diff}}$ that fills this diagram as follows:

$$\begin{array}{ccccc} \exp(\mathfrak{g})_{\text{diff}} & \xrightarrow{\exp(\mu, cs)} & \mathbf{B}^n \mathbb{R}_{\text{diff, smp}} & \xrightarrow{\text{curv}_{\text{smp}}} & \mathfrak{b}_{\text{dR}} \mathbf{B}^{n+1} \mathbb{R}_{\text{smp}} \ . \\ \downarrow \simeq & & \downarrow \simeq & & \\ \exp(\mathfrak{g}) & \xrightarrow{\exp(\mu)} & \mathbf{B}^n \mathbb{R}_{\text{smp}} & & \end{array}$$

Given this, $\exp(\mathfrak{g})_{\text{diff, smp}}$ serves as a new resolution of $\exp(\mathfrak{g})$ for which the composite differential characteristic class is presented by the ordinary composite of morphisms of simplicial presheaves $\text{curv}_{\text{smp}} \circ \exp(\mu, cs)$.

This object $\exp(\mathfrak{g})_{\text{diff}}$ we shall see may be interpreted as the coefficient for *pseudo*- ∞ -connections with values in \mathfrak{g} .

There is however still room to adjust this presentation such as to yield in each cohomology class special nice cocycle representatives. This we will achieve by finding naturally a subobject $\exp(\mathfrak{g})_{\text{conn}} \hookrightarrow \exp(\mathfrak{g})_{\text{diff}}$ whose inclusion is an isomorphism on connected components and restricted to which the morphism $\text{curv}_{\text{smp}} \circ \exp(\mu, cs)$ yields nice representatives in the de Rham hypercohomology encoded by $\mathfrak{b}_{\text{dR}} \mathbf{B}^{n+1} \mathbb{R}_{\text{smp}}$, namely globally defined differential forms. On this object the differential characteristic classes we will show factors naturally through the refinements to differential cohomology, and hence $\exp(\mathfrak{g})_{\text{conn}}$ is finally identified as a presentation for the coefficient object for ∞ -connections with values in \mathfrak{g} .

Let $\mathfrak{g} \in L_\infty \xrightarrow{\text{CE}} \text{dgAlg}^{\text{op}}$ be an L_∞ -algebra, def. 1.2.143.

Definition 4.4.102. A L_∞ -algebra cocycle on \mathfrak{g} in degree n is a morphism

$$\mu : \mathfrak{g} \rightarrow b^{n-1} \mathbb{R}$$

to the line Lie n -algebra.

Observation 4.4.103. Dually this is equivalently a morphism of dg-algebras

$$\text{CE}(\mathfrak{g}) \leftarrow \text{CE}(b^{n-1} \mathbb{R}) : \mu,$$

which we denote by the same letter, by slight abuse of notation. Such a morphism is naturally identified with its image of the single generator of $\text{CE}(b^{n-1} \mathbb{R})$, which is a closed element

$$\mu \in \text{CE}(\mathfrak{g})$$

in degree n , that we also denote by the same letter. Therefore L_∞ -algebra cocycles are precisely the ordinary cocycles of the corresponding Chevalley-Eilenberg algebras.

Remark 4.4.104. After the injection of smooth ∞ -groupoids into synthetic differential ∞ -groupoids, discussed below in 4.5, there is an intrinsic abstract notion of cohomology of ∞ -Lie algebras. Proposition 4.5.45 below asserts that the above definition is indeed a presentation of that abstract cohomological notion.

Definition 4.4.105. For $\mu : \mathfrak{g} \rightarrow b^{n-1} \mathbb{R}$ an L_∞ -algebra cocycle with $n \geq 2$, write \mathfrak{g}_μ for the L_∞ -algebra whose Chevalley-Eilenberg algebra is generated from the generators of $\text{CE}(\mathfrak{g})$ and one single further generator b in degree $(n - 1)$, with differential defined by

$$d_{\text{CE}(\mathfrak{g}_\mu)}|_{\mathfrak{g}^*} = d_{\text{CE}(\mathfrak{g})},$$

and

$$d_{\text{CE}(\mathfrak{g}_\mu)} : b \mapsto \mu,$$

where on the right we regard μ as an element of $\text{CE}(\mathfrak{g})$, hence of $\text{CE}(\mathfrak{g}_\mu)$, by observation 4.4.103.

Remark 4.4.106. Below in prop. 4.5.47 we show that, in the context of *synthetic differential cohesion* 4.5, \mathfrak{g}_μ is indeed the extension of \mathfrak{g} classified by μ in the general sense of 3.6.14.

Definition 4.4.107. For $\mathfrak{g} \in L_\infty\text{Alg}$ an L_∞ -algebra, its *Weil algebra* $W(\mathfrak{g}) \in \text{dgAlg}$ is the unique representative of the free dg-algebra on the dual cochain complex underlying \mathfrak{g} such that the canonical projection $\mathfrak{g}_\bullet^*[1] \oplus \mathfrak{g}_\bullet^*[2] \rightarrow \mathfrak{g}_\bullet^*[1]$ extends to a dg-algebra homomorphism

$$\text{CE}(\mathfrak{g}) \leftarrow W(\mathfrak{g}).$$

Since $W(\mathfrak{g})$ is itself in $L_\infty\text{Alg}^{\text{op}} \hookrightarrow \text{dgAlg}$ we can identify it with the Chevalley-Eilenberg algebra of an L_∞ -algebra. That we write $\text{inn}(\mathfrak{g})$ or $e\mathfrak{g}$:

$$W(\mathfrak{g}) :=: \text{CE}(e\mathfrak{g}).$$

In terms of this the above canonical morphism reads

$$\mathfrak{g} \rightarrow e\mathfrak{g}.$$

Remark 4.4.108. This notation reflects the fact that $e\mathfrak{g}$ may be regarded as the infinitesimal groupal model of the universal \mathfrak{g} -principal ∞ -bundle.

Proposition 4.4.109. For $n \in \mathbb{N}$, $n \geq 2$ we have a pullback in $L_\infty\text{Alg}$

$$\begin{array}{ccc} b^{n-1}\mathbb{R} & \longrightarrow & eb^{n-1}\mathbb{R} \\ \downarrow & & \downarrow \\ * & \longrightarrow & bb^{n-1}\mathbb{R} \end{array}.$$

Proof. Dually this is the pushout diagram of dg-algebras that is free on the short exact sequence of cochain complexes concentrated in degrees n and $n+1$ as follows:

$$\left(\begin{array}{c} 0_{n+1} \\ \uparrow \\ d_{\text{CE}(b^{n-1}\mathbb{R})} \\ \downarrow \\ \langle c \rangle_n \end{array} \right) \leftarrow \left(\begin{array}{c} \langle d \rangle_{n+1} \\ \uparrow \simeq \\ d_{\text{CE}(eb^{n-1}\mathbb{R})} \\ \downarrow \\ \langle c \rangle_n \end{array} \right) \leftarrow \left(\begin{array}{c} \langle d \rangle_{n+1} \\ \uparrow \\ d_{\text{CE}(bb^{n-1}\mathbb{R})} \\ \downarrow \\ 0_n \end{array} \right).$$

□

Proposition 4.4.110. The L_∞ -algebra \mathfrak{g}_μ from def. 4.4.105 fits into a pullback diagram in $L_\infty\text{Alg}$

$$\begin{array}{ccc} \mathfrak{g}_\mu & \longrightarrow & eb^{n-2}\mathbb{R} \\ \downarrow & & \downarrow \\ \mathfrak{g} & \xrightarrow{\mu} & bb^{n-2}\mathbb{R} \end{array}.$$

Proposition 4.4.111. Let $\mu : \mathfrak{g} \rightarrow b^n\mathbb{R}$ be a degree- n cocycle on an L_∞ -algebra and \mathfrak{g}_μ the L_∞ -algebra from def. 4.4.105.

We have that $\text{exp}(\mathfrak{g}_\mu) \rightarrow \text{exp}(\mathfrak{g})$ presents the homotopy fiber of $\text{exp}(\mu) : \text{exp}(\mathfrak{g}) \rightarrow \text{exp}(b^{n-1}\mathbb{R})$ in $[\text{CartSp}^{\text{op}}, \text{sSet}]_{\text{proj,loc}}$.

Since $\exp(b^{n-1}\mathbb{R}) \simeq \mathbf{B}^n\mathbb{R}$ by prop. 4.4.64, this means that $\exp(\mathfrak{g}_\mu)$ is the $\mathbf{B}^{n-1}\mathbb{R}$ -principal ∞ -bundle classified by $\exp(\mu)$ in that we have an ∞ -pullback

$$\begin{array}{ccc} \exp(\mathfrak{g}_\mu) & \longrightarrow & * \\ \downarrow & & \downarrow \\ \exp(\mathfrak{g}) & \xrightarrow{\exp(\mu)} & \mathbf{B}^n\mathbb{R} \end{array}$$

in $\text{Smooth}\infty\text{Grpd}$.

Proof. Since $\exp : L_\infty\text{Alg} \rightarrow [\text{CartSp}^{\text{op}}, \text{sSet}]$ preserves pullbacks (being given componentwise by a hom-functor) it follows from 4.4.110 that we have a pullback diagram

$$\begin{array}{ccc} \exp(\mathfrak{g}_\mu) & \longrightarrow & \exp(eb^{n-1}\mathbb{R}) \\ \downarrow & & \downarrow \\ \exp(\mathfrak{g}) & \xrightarrow{\exp(\mu)} & \exp(b^{n-1}\mathbb{R}) \end{array} .$$

The right vertical morphism is a fibration resolution of the point inclusion $* \rightarrow \exp(b^{n-1}\mathbb{R})$. Hence this is a homotopy pullback in $[\text{CartSp}^{\text{op}}, \text{sSet}]_{\text{proj}}$ and the claim follows with prop. 2.3.13. \square

We now come to the definition of differential refinements of exponentiated L_∞ -algebras.

Definition 4.4.112. For $\mathfrak{g} \in L_\infty$ define the simplicial presheaf $\exp(\mathfrak{g})_{\text{diff}} \in [\text{CartSp}_{\text{smooth}}^{\text{op}}, \text{sSet}]$ by

$$\exp(\mathfrak{g})_{\text{diff}} : (U, [k]) \mapsto \left\{ \begin{array}{ccc} \Omega_{\text{si,vert}}^\bullet(U \times \Delta^k) & \longleftarrow & \text{CE}(\mathfrak{g}) \\ \uparrow & & \uparrow \\ \Omega^\bullet(U \times \Delta^k) & \longleftarrow & \text{W}(\mathfrak{g}) \end{array} \right\},$$

where on the left we have the set of commuting diagrams in dgAlg as indicated, with the vertical morphisms being the canonical projections.

Proposition 4.4.113. *The canonical projection*

$$\exp(\mathfrak{g})_{\text{diff}} \rightarrow \exp(\mathfrak{g})$$

is a weak equivalence in $[\text{CartSp}_{\text{smooth}}^{\text{op}}, \text{sSet}]_{\text{proj}}$.

Moreover, for every L_∞ -algebra cocycle it fits into a commuting diagram

$$\begin{array}{ccccc} \exp(\mathfrak{g})_{\text{diff}} & \xrightarrow{\exp(\mu)_{\text{diff}}} & \exp(b^{n-1}\mathbb{R})_{\text{diff}} & \xlongequal{\quad} & \mathbf{B}^n\mathbb{R}_{\text{diff,smp}} \\ \downarrow \simeq & & \downarrow \simeq & & \downarrow \simeq \\ \exp(\mathfrak{g}) & \xrightarrow{\exp(\mu)} & \exp(b^{n-1}\mathbb{R}) & \xlongequal{\quad} & \mathbf{B}^n\mathbb{R}_{\text{smp}} \end{array}$$

for some morphism $\exp(\mu)_{\text{diff}}$.

Proof. Use the contractibility of the Weil algebra. \square

Definition 4.4.114. Let $G \in \text{Smooth}\infty\text{Grpd}$ be a smooth n -group given by Lie integration, 4.4.14, of an L_∞ algebra \mathfrak{g} , in that the delooping object $\mathbf{B}G$ is presented by the $(n+1)$ -coskeleton simplicial presheaf $\text{cosk}_{n+1} \exp(\mathfrak{g})$, def. 3.6.28.

Then for $X \in [\text{CartSp}_{\text{smooth}}, \text{sSet}]_{\text{proj}}$ any object and \hat{X} a cofibrant resolution, we say that

$$[\text{CartSp}_{\text{smooth}}^{\text{op}}, \text{sSet}](\hat{X}, \mathbf{cosk}_{n+1} \exp(\mathfrak{g})_{\text{diff}})$$

is the Kan complex of *pseudo- n -connections* on G -principal n -bundles.

We discuss now subobjects that pick out genuine ∞ -connections.

Definition 4.4.115. An *invariant polynomial* on an L_∞ -algebra \mathfrak{g} is an element $\langle - \rangle \in W(\mathfrak{g})$ in the Weil algebra, such that

1. $d_{W(\mathfrak{g})} \langle -, - \rangle = 0$;
2. $\langle - \rangle \in \wedge^\bullet \mathfrak{g}^*[1] \hookrightarrow W(\mathfrak{g})$;

hence such that it is a closed element built only from shifted generators of $W(\mathfrak{g})$.

Proposition 4.4.116. For \mathfrak{g} an ordinary Lie algebra, this definition of invariant polynomial is equivalent to the traditional one (for instance [AzIz95]).

Proof. Let $\{t^a\}$ be a basis of \mathfrak{g}^* and $\{r^a\}$ the corresponding basis of $\mathfrak{g}^*[1]$. Write $\{C^a_{bc}\}$ for the structure constants of the Lie bracket in this basis.

Then for $P = P_{(a_1, \dots, a_k)} r^{a_1} \wedge \dots \wedge r^{a_k} \in \wedge^r \mathfrak{g}^*[1]$ an element in the shifted generators, the condition that its image under $d_{W(\mathfrak{g})}$ is in the shifted copy is equivalent to

$$C^b_{c(a_1} P_{b, \dots, a_k)} t^c \wedge r^{a_1} \wedge \dots \wedge r^{a_k} = 0,$$

where the parentheses around indices denotes symmetrization, so that this is equivalent to

$$\sum_i C^b_{c(a_i} P_{a_1 \dots a_{i-1} b a_{i+1} \dots a_k)} = 0$$

for all choice of indices. This is the component-version of the defining invariance statement

$$\sum_i P(t_1, \dots, t_{i-1}, [t_c, t_i], t_{i+1}, \dots, t_k) = 0$$

for all $t_\bullet \in \mathfrak{g}$. □

Observation 4.4.117. For the line Lie n -algebra we have

$$\text{inv}(b^{n-1}\mathbb{R}) \simeq \text{CE}(b^n\mathbb{R}).$$

This allows us to identify an invariant polynomial $\langle - \rangle$ of degree $n + 1$ with a morphism

$$\text{inv}(\mathfrak{g}) \xleftarrow{\langle - \rangle} \text{inv}(b^{n-1}\mathbb{R})$$

in dgAlg .

Remark 4.4.118. Write $\iota : \mathfrak{g} \rightarrow \text{Der}_\bullet(W(\mathfrak{g}))$ for the identification of elements of \mathfrak{g} with inner graded derivations of the Weil-algebra, induced by contraction. For $v \in \mathfrak{g}$ write

$$\mathcal{L}_x := [d_{W(\mathfrak{g})}, \iota_v] \in \text{der}_\bullet(W(\mathfrak{g}))$$

for the induced Lie derivative. Then the first condition on an invariant polynomial $\langle - \rangle$ in def. 4.4.115 is equivalent to

$$\iota_v \langle - \rangle = 0 \quad \forall v \in \mathfrak{g}$$

and the second condition implies that

$$\mathcal{L}_v \langle - \rangle = 0 \quad \forall v \in \mathfrak{g}.$$

In Cartan calculus [Cart50a][Cart50b] elements satisfying these two conditions are called *basic elements* or *basic forms*. By prop. 4.4.116 on an ordinary Lie algebra the basic forms are precisely the invariant polynomials. But on a general L_∞ -algebra there can be non-closed basic forms. Our definition of invariant polynomials hence picks the *closed basic forms* on an L_∞ -algebra.

Definition 4.4.119. We say that an invariant polynomial $\langle - \rangle$ on \mathfrak{g} is *in transgression* with an L_∞ -algebra cocycle $\mu : \mathfrak{g} \rightarrow b^{n-1}\mathbb{R}$ if there is a morphism $cs : W(b^{n-1}\mathbb{R}) \rightarrow W(\mathfrak{g})$ such that we have a commuting diagram

$$\begin{array}{ccc} CE(\mathfrak{g}) & \xleftarrow{\mu} & CE(b^{n-1}\mathbb{R}) \\ \uparrow & & \uparrow \\ W(\mathfrak{g}) & \xleftarrow{cs} & W(b^{n-1}\mathbb{R}) \\ \uparrow & & \uparrow \\ inv(\mathfrak{g}) & \xleftarrow{\langle - \rangle} & inv(b^{n-1}\mathbb{R}) \equiv CE(b^n\mathbb{R}) \end{array}$$

hence such that

1. $d_{W(\mathfrak{g})}cs = \langle - \rangle$;
2. $cs|_{CE(\mathfrak{g})} = \mu$.

We say that cs is a *Chern-Simons element* exhibiting the transgression between μ and $\langle - \rangle$.

We say that an L_∞ -algebra cocycle is *transgressive* if it is in transgression with some invariant polynomial.

Observation 4.4.120. We have

1. There is a transgressive cocycle for every invariant polynomial.
2. Any two L_∞ -algebra cocycles in transgression with the same invariant polynomial are cohomologous.
3. Every decomposable invariant polynomial (the wedge product of two non-vanishing invariant polynomials) transgresses to a cocycle cohomologous to 0.

Proof.

1. By the fact that the Weil algebra is free, its cochain cohomology vanishes and hence the definition property $d_{W(\mathfrak{g})}\langle - \rangle = 0$ implies that there is some element $cs \in W(\mathfrak{g})$ such that $d_{W(\mathfrak{g})}cs = \langle - \rangle$. Then the image of cs along the canonical dg-algebra homomorphism $W(\mathfrak{g}) \rightarrow CE(\mathfrak{g})$ is $d_{CE(\mathfrak{g})}$ -closed hence is a cocycle on \mathfrak{g} . This is by construction in transgression with $\langle - \rangle$.
2. Let cs_1 and cs_2 be Chern-Simons elements for the to given L_∞ -algebra cocycles. Then by assumption $d_{(\mathfrak{g})}(cs_1 - cs_2) = 0$. By the acyclicity of $W(\mathfrak{g})$ there is then $\lambda \in W(\mathfrak{g})$ such that $cs_1 = cs_2 + d_{W(\mathfrak{g})}\lambda$. Since $W(\mathfrak{g}) \rightarrow CE(\mathfrak{g})$ is a dg-algebra homomorphism this implies that also $\mu_1 = \mu_2 + d_{CE(\mathfrak{g})}\lambda|_{CE(\mathfrak{g})}$.
3. Given two nontrivial invariant polynomials $\langle - \rangle_1$ and $\langle - \rangle_2$ let $cs_1 \in W(\mathfrak{g})$ be any element such that $d_{W(\mathfrak{g})}cs_1 = \langle - \rangle_1$. Then $cs_{1,2} := cs_1 \wedge \langle - \rangle_2$ satisfies $d_{W(\mathfrak{g})}cs_{1,2} = \langle - \rangle_1 \wedge \langle - \rangle_2$. By the first observation the restriction of $cs_{1,2}$ to $CE(\mathfrak{g})$ is therefore a cocycle in transgression with $\langle - \rangle_1 \wedge \langle - \rangle_2$. But by the definition of invariant polynomials the restriction of $\langle - \rangle_2$ vanishes, and hence so does that of $cs_{1,2}$. The claim the follows with the second point above.

□

The following notion captures the equivalence relation induced by lifts of cocycles to Chern-Simons elements on invariant polynomials.

Definition 4.4.121. We say two invariant polynomials $\langle - \rangle_1, \langle - \rangle_2 \in W(\mathfrak{g})$ are *horizontally equivalent* if there exists $\omega \in \ker(W(\mathfrak{g}) \rightarrow CE(\mathfrak{g}))$ such that

$$\langle - \rangle_1 = \langle - \rangle_2 + d_{W(\mathfrak{g})}\omega.$$

Observation 4.4.122. Every decomposable invariant polynomial is horizontally equivalent to 0.

Proof. By the argument of prop. 4.4.120, item iii): for $\langle - \rangle = \langle - \rangle_1 \wedge \langle - \rangle_2$ let cs_1 be a Chern-Simons element for $\langle - \rangle_1$. Then $cs_1 \wedge \langle - \rangle_2$ exhibits a horizontal equivalence $\langle - \rangle \sim 0$. \square

Proposition 4.4.123. For \mathfrak{g} an L_∞ -algebra, $\mu : \mathfrak{g} \rightarrow b^n\mathbb{R}$ a cocycle in transgression to an invariant polynomial $\langle \rangle$ on \mathfrak{g} and \mathfrak{g}_μ the corresponding shifted central extension, 4.4.105, we have that

1. $\langle - \rangle$ defines an invariant polynomial also on \mathfrak{g}_μ , by the defining identification of generators;
2. but on \mathfrak{g}_μ the invariant polynomial $\langle - \rangle$ is horizontally trivial.

Proof. \square

Definition 4.4.124. For \mathfrak{g} an L_∞ -algebra we write $\text{inv}(\mathfrak{g})$ for the free graded algebra on horizontal equivalence classes of invariant polynomials. We regard this as a dg-algebra with trivial differential. This comes with an inclusion of dg-algebras

$$\text{inv}(\mathfrak{g}) \rightarrow W(\mathfrak{g})$$

given by a choice of representative for each class.

Observation 4.4.125. The algebra $\text{inv}(\mathfrak{g})$ is generated from indecomposable invariant polynomials.

Proof. By observation 4.4.122. \square

Definition 4.4.126. Define the simplicial presheaf $\text{exp}(\mathfrak{g})_{\text{ChW}} \in [\text{CartSp}_{\text{smooth}}^{\text{op}}, \text{sSet}]$ by the assignment

$$\text{exp}(\mathfrak{g})_{\text{ChW}} : (U, [k]) \mapsto \left\{ \begin{array}{ccc} \Omega_{\text{si,vert}}^\bullet(U \times \Delta^k) & \xleftarrow{A_{\text{vert}}} & CE(\mathfrak{g}) \\ \uparrow & & \uparrow \\ \Omega_{\text{si}}^\bullet(U \times \Delta^k) & \xleftarrow{A} & W(\mathfrak{g}) \\ \uparrow & & \uparrow \\ \Omega^\bullet(U) & \xleftarrow{\langle F_A \rangle} & \text{inv}(\mathfrak{g}) \end{array} \right\},$$

where on the right we have the set of horizontal morphisms in dgAlg making commuting diagrams with the canonical vertical morphisms as indicated.

We call $\langle F_A \rangle$ the *curvature characteristic forms* of A .

Let

$$\begin{array}{ccc} \text{exp}(\mathfrak{g})_{\text{diff}} & \xrightarrow{(\text{exp}(\mu_i, cs_i))_i} & \prod_i \text{exp}(b^{n_i-1}\mathbb{R})_{\text{diff}} & \xrightarrow{((\text{curv}_i)_{\text{smp}})} & \prod_i b_{\text{dR}}\mathbf{B}_{\text{smp}}^{n_i} \\ \downarrow \simeq & & & & \\ \text{exp}(\mathfrak{g}) & & & & \end{array}$$

be the presentation, as above, of the product of all differential refinements of characteristic classes on $\text{exp}(\mathfrak{g})$ induced from Lie integration of transgressive L_∞ -algebra cocycles.

Proposition 4.4.127. *We have that $\exp(\mathfrak{g})_{\text{ChW}}$ is the pullback in $[\text{CartSp}_{\text{smooth}}^{\text{op}}, \text{sSet}]$ of the globally defined closed forms along the curvature characteristics induced by all transgressive L_∞ -algebra cocycles:*

$$\begin{array}{ccc}
\exp(\mathfrak{g})_{\text{ChW}} & \xrightarrow{\exp(\mu, cs)} & \prod_{n_i} \Omega_{\text{cl}}^{n_i+1}(-) \\
\downarrow & & \downarrow \\
\exp(\mathfrak{g})_{\text{diff, smp}} & \xrightarrow{(\text{curv}_i)_i} & \prod_i \mathfrak{b}_{\text{dR}} \mathbf{B}^{n_i+1} \mathbb{R}_{\text{smp}} \\
\downarrow \simeq & & \\
\exp(\mathfrak{g}) & &
\end{array}$$

Proof. By prop. 4.4.80 we have that the bottom horizontal morphism sends over each $(U, [k])$ and for each i an element

$$\begin{array}{ccc}
\Omega_{\text{si, vert}}^\bullet(U \times \Delta^k) & \xleftarrow{A_{\text{vert}}} & \text{CE}(\mathfrak{g}) \\
\uparrow & & \uparrow \\
\Omega_{\text{si}}^\bullet(U \times \Delta^k) & \xleftarrow{A} & \text{W}(\mathfrak{g})
\end{array}$$

of $\exp(\mathfrak{g})(U)_k$ to the composite

$$\begin{aligned}
& \left(\Omega_{\text{si}}^\bullet(U \times \Delta^k) \xleftarrow{A} \text{W}(\mathfrak{g}) \xleftarrow{cs_i} \text{W}(b^{n_i-1}\mathbb{R}) \leftarrow \text{inv}(b^{n_i}\mathbb{R}) = \text{CE}(b^{n_i}\mathbb{R}) \right) \\
& = \left(\Omega_{\text{si}}^\bullet(U \times \Delta^k) \xleftarrow{\langle F_A \rangle_i} \text{CE}(b^{n_i}\mathbb{R}) \right)
\end{aligned}$$

regarded as an element in $\mathfrak{b}_{\text{dR}} \mathbf{B}_{\text{smp}}^{n_i+1}(U)_k$. The right vertical morphism $\Omega^{n_i+1}(U) \rightarrow \mathfrak{b}_{\text{dR}} \mathbf{B}_{\text{smp}}^{n_i+1} \mathbb{R}_{\text{smp}}(U)$ from the constant simplicial set of closed $(n_i + 1)$ -forms on U picks precisely those of these elements for which $\langle F_A \rangle$ is a basic form on the $U \times \Delta^k$ -bundle in that it is in the image of the pullback $\Omega^\bullet(U) \rightarrow \Omega_{\text{si}}^\bullet(U \times \Delta^k)$. \square

This way the abstract differential refinement recovers the notion of ∞ -connections from Lie integration discussed before in 1.2.8.6.

4.4.18 Higher holonomy and parallel transport – Fiber integration in differential cohomology

We discuss the general notion of higher holonomy, 4.4.18, realized in smooth cohesion.

Let $n, k \in \mathbb{N}$ with $k \leq n$. For

$$\Sigma_k \in \text{SmoothMfd} \hookrightarrow \text{Smooth}\infty\text{Grpd}$$

a closed manifold equipped with an orientation, the ordinary fiber integration of differential forms

$$\int_{\Sigma_k} : \Omega^n(\Sigma_k \times U) \longrightarrow \Omega^{n-k}(U)$$

is natural in $U \in \text{CartSp} \in \text{SmoothMfd}$ and hence comes from a morphism of smooth spaces

$$\int_{\Sigma_k} : [\Sigma_k, \Omega^n] \longrightarrow \Omega^{n-k}$$

in $\text{Smooth}\infty\text{Grpd}$. Similarly, transgression in ordinary cohomology constitutes a morphism in $\text{Smooth}\infty\text{Grpd}$. This induces a fiber integration formula also on cococycles in $\mathbf{B}^n U(1)_{\text{conn}}$. The following statement expresses this situation in detail. This is theorem 3.1 of [GoTe00], where we observe that under the Dold-Kan correspondence it induces the following statement about smooth moduli stacks.

Definition 4.4.128 (Planck's constant). We label embeddings of abelian groups

$$\frac{1}{2\pi\hbar} : \mathbb{Z} \hookrightarrow \mathbb{R}$$

by

$$\hbar \in \mathbb{R} - \{0\}$$

such that the embedding sends $1 \in \mathbb{Z}$ to $\frac{1}{2\pi\hbar} \in \mathbb{R}$.

Remark 4.4.129. This constant $2\pi\hbar$ is what in physics is called *Planck's constant*. With this constant chosen and under the canonical identification $\mathbb{R}/\mathbb{Z} \simeq U(1)$ the corresponding quotient map is

$$\mathbb{R} \hookrightarrow \mathbb{R} \xrightarrow{\exp\left(\frac{i}{\hbar}(-)\right)} U(1).$$

Proposition 4.4.130 (fiber integration of differential cocycles). For Σ_k a closed oriented manifold, we have horizontal morphisms making the following diagram commute

$$\begin{array}{ccc} [\Sigma_k, \mathbf{B}^n U(1)_{\text{conn}}] & \xrightarrow{\exp\left(\frac{i}{\hbar} \int_{\Sigma_k} (-)\right)} & \mathbf{B}^{n-k} U(1)_{\text{conn}} \\ \downarrow & & \downarrow \\ [\Sigma_k, \Omega_{\text{cl}}^{n+1}] & \xrightarrow{\int_{\Sigma_k} (-)} & \Omega_{\text{cl}}^{n+1-k} \\ \downarrow [\Sigma_k, \mathbf{L}_{\text{tYM}}^{n+1}] & & \downarrow \\ [\Sigma_k, \mathbf{bB}^{n+1} U(1)] & \xrightarrow{\exp\left(\frac{i}{\hbar} \int_{\Sigma_k} (-)\right)} & \mathbf{bB}^{n+1-k} U(1). \end{array}$$

Moreover, for Σ_k an oriented manifold with boundary $\partial\Sigma_k$ of dimension $(k-1)$ we have a diagram

$$\begin{array}{ccc} & [\Sigma_k, \mathbf{B}^n U(1)_{\text{conn}}] & \\ \swarrow (-)|_{\partial\Sigma} & & \searrow \omega_{\Sigma} \\ [\partial\Sigma_k, \mathbf{B}^n U(1)_{\text{conn}}] & \xrightarrow{\exp\left(\frac{i}{\hbar} \int_{\Sigma} (-)\right)} & \Omega^{n-k+1} \\ \swarrow \exp\left(\frac{i}{\hbar} \int_{\partial\Sigma} (-)\right) & & \searrow \\ & \mathbf{B}^{n-k+1} U(1)_{\text{conn}} & \end{array}$$

such that when $\partial\Sigma_k = \emptyset$ the homotopy filling this diagram coincides with the above integration map under the identification

$$\mathbf{B}^{n-k} U(1)_{\text{conn}} \simeq * \times_{\mathbf{B}^{n-k+1} U(1)_{\text{conn}}} \Omega_{\text{cl}}^{n-k+1};$$

hence for the case of no boundary $\partial\Sigma_k = \emptyset$ we have

$$\begin{array}{ccc} & [\Sigma_k, \mathbf{B}^n U(1)_{\text{conn}}] & \\ \swarrow & & \searrow \omega_{\Sigma} \\ * & \xrightarrow{\exp\left(\frac{i}{\hbar} \int_{\Sigma} (-)\right)} & \Omega^{n-k+1} \\ \swarrow & & \searrow \\ & \mathbf{B}^{n-k+1} U(1)_{\text{conn}} & \end{array} \simeq \begin{array}{ccc} & [\Sigma_k, \mathbf{B}^n U(1)_{\text{conn}}] & \\ \swarrow \exp\left(\frac{i}{\hbar} \int_{\Sigma_k} (-)\right) & & \searrow \omega_{\Sigma} \\ * & \xrightarrow{F(-)} & \Omega^{n-k+1} \\ \swarrow 0 & & \searrow \\ & \mathbf{B}^{n-k+1} U(1)_{\text{cl}} & \end{array}$$

Proof. For the first statement, we need to produce for each $U \in \text{CartSp} \hookrightarrow \text{SmoothMfd}$ a map

$$\mathbf{H}(U \times \Sigma_k, \mathbf{B}^n U(1)_{\text{conn}}) \longrightarrow \mathbf{H}(U, \mathbf{B}^{n-k} U(1)_{\text{conn}})$$

such that this is natural in U . By the general discussion of $\mathbf{B}^n U(1)_{\text{conn}}$, after a choice of good open cover \mathcal{U} of Σ_k (inducing the good cover $\mathcal{U} \times U$ of $\Sigma_k \times U$) this is given, under the Dold-Kan correspondence $\text{DK}(-)$, by a chain map of the form

$$\begin{array}{ccccccc} C^n(\mathcal{U} \times U, \underline{U}(1) \rightarrow \dots \rightarrow \Omega^n) & \xrightarrow{D} & \dots & \xrightarrow{D} & C^1(\mathcal{U} \times U, \underline{U}(1) \rightarrow \dots \rightarrow \Omega^n) & \xrightarrow{D} & Z^0(\mathcal{U} \times U, \underline{U}(1) \rightarrow \dots \rightarrow \Omega^n) \\ \downarrow f_\Sigma & & \dots & & \downarrow f_\Sigma & & \downarrow f_\Sigma \\ 0 & \longrightarrow & \dots & \longrightarrow & C^1(U, \underline{U}(1) \rightarrow \dots \rightarrow \Omega^{n-k}) & \xrightarrow{D} & Z^0(U, \underline{U}(1) \rightarrow \dots \rightarrow \Omega^{n-k}) . \end{array}$$

In [GoTe00] a map f_Σ as above is defined and theorem 2.1 there asserts that it satisfies the equation

$$\int_\Sigma \circ D - (-1)^k D \circ \int_\Sigma = \int_{\partial\Sigma} \circ (-)|_{\partial\Sigma} \quad (\star)$$

in (and this is important) the chain complex $C^\bullet(\mathcal{U} \times U, \underline{U}(1) \rightarrow \dots \rightarrow \Omega^{n-k})$. For $\partial\Sigma_k = \emptyset$ this asserts that f_Σ is a chain map as needed for the above.

Next, for the more general statement in the presence of a boundary, we are instead in interpreting formula (\star) as a chain homotopy taking place in $C^\bullet(\mathcal{U} \times U, \underline{U}(1) \rightarrow \dots \rightarrow \Omega^{n-k+1})$

$$\begin{array}{ccccccc} \dots & \xrightarrow{D} & C^1(\mathcal{U} \times U, \underline{U}(1) \rightarrow \dots \rightarrow \Omega^n) & \xrightarrow{D} & Z^0(\mathcal{U} \times U, \underline{U}(1) \rightarrow \dots \rightarrow \Omega^n) & & \\ & \searrow f_\Sigma & & \searrow f_\Sigma & & & \\ C^2(U, \underline{U}(1) \rightarrow \dots \rightarrow \Omega^{n-k+1}) & \xrightarrow{D} & C^1(U, \underline{U}(1) \rightarrow \dots \rightarrow \Omega^{n-k+1}) & \xrightarrow{D} & Z^0(U, \underline{U}(1) \rightarrow \dots \rightarrow \Omega^{n-k+1}) . & & \end{array}$$

The subtlety to be taken care of now is that the equation in theorem 2.1 of [GoTe00] holds in the chain complex $C^\bullet(\mathcal{U} \times U, \underline{U}(1) \rightarrow \dots \rightarrow \Omega^{n-k})$ instead of in $C^\bullet(\mathcal{U} \times U, \underline{U}(1) \rightarrow \dots \rightarrow \Omega^{n-k+1})$ as we need it here. But the difference is only that in the latter complex the Deligne differential of an $(n-k)$ -form on single patches differs from that in the former by the de Rham differential d of that differential form, which is by definition absent in the former case. But by degree-counting this difference appears only in the map

$$D : C^1(U, \underline{U}(1) \rightarrow \dots \rightarrow \Omega^{n-k+1}) \rightarrow Z^0(U, \underline{U}(1) \rightarrow \dots \rightarrow \Omega^{n-k+1}) = \Omega^{n-k+1}(U) .$$

Therefore, we may absorb it by modifying the integration chain map in degree 0. To that end, notice that for $\mathcal{A} \in Z^0(\mathcal{U} \times U, \underline{U}(1) \rightarrow \dots \rightarrow \Omega^{n-k})$ we have that

$$(0, \dots, 0, (\int_{\partial\Sigma} \mathcal{A}|_{\partial\Sigma})_i - d(\int_\Sigma \mathcal{A})_i) \in Z^0(U, \underline{U}(1) \rightarrow \dots \rightarrow \Omega^{n-k+1})$$

(hence that the difference is a globally well defined differential form), since

$$\delta(\int_{\partial\Sigma} \mathcal{A}|_{\partial\Sigma})_{ij} = \pm d(\int_{\partial\Sigma} \mathcal{A}|_{\partial\Sigma})_{ij} ,$$

this being the (ij) -component of the identity $D(\int_{\partial\Sigma} \mathcal{A}|_{\partial\Sigma}) = 0$ given by the version of (\star) without boundary applied to the boundary, and since also

$$\delta(d(\int_\Sigma \mathcal{A}))_{ij} = d(\delta(\int_\Sigma \mathcal{A}))_{ij} = d(\int_{\partial\Sigma} \mathcal{A}|_{\partial\Sigma})_{ij} ,$$

this being the image under d of the (ij) -component of (\star) applied to the cocycle \mathcal{A} , which gives $D \int_{\Sigma} \mathcal{A} = \int_{\partial \Sigma} \mathcal{A}|_{\partial \Sigma}$. Therefore, there is a natural chain map

$$\begin{array}{ccccccc}
\dots & \xrightarrow{D} & C^1(\mathcal{U} \times U, \underline{U}(1) \rightarrow \dots \rightarrow \Omega^n) & \xrightarrow{D} & Z^0(\mathcal{U} \times U, \underline{U}(1) \rightarrow \dots \rightarrow \Omega^n) & & \\
& & \downarrow & & \downarrow \mathcal{A} \mapsto (\int_{\partial \Sigma} \mathcal{A}|_{\partial \Sigma})_i - d(\int_{\Sigma} \mathcal{A})_i & & \\
\dots & \longrightarrow & 0 & \longrightarrow & \Omega^{n-k+1}(U) & & \\
& & \downarrow & & \downarrow = & & \\
\dots & \xrightarrow{D} & C^1(U, \underline{U}(1) \rightarrow \dots \rightarrow \Omega^{n-k+1}) & \xrightarrow{D} & Z^0(U, \underline{U}(1) \rightarrow \dots \rightarrow \Omega^{n-k+1}), & &
\end{array}$$

which under $\text{DK}(-)$ presents the map denoted

$$[\Sigma_k, \mathbf{B}^n U(1)_{\text{conn}}] \xrightarrow{\omega_{\Sigma}} \Omega^{n-k+1} \longrightarrow \mathbf{B}^{n-k+1} U(1)_{\text{conn}}$$

in the above statement. This is now manifestly so that adding its negative to the right of equation (\star) makes this equation define a chain homotopy in $C^{\bullet}(\mathcal{U} \times U, \underline{U}(1) \rightarrow \dots \rightarrow \Omega^{n-k+1})$ of the form

$$[D, \int_{\Sigma}] : \int_{\partial \Sigma} (-)|_{\partial \Sigma} \Rightarrow \omega_{\Sigma} .$$

□

Remark 4.4.131. These maps express the relative higher *holonomy* and *parallel transport* of n -form connections, respectively. The second statement says that the parallel transport of an n -connection over a k -dimensional manifold with boundary is a section of the $\mathbf{B}^{n-k} U(1)$ -principal bundle underlying the transgression of the underlying $\mathbf{B}^{n-1} U(1)$ -principal connection to the mapping space out of the boundary $\partial \Sigma_k$. The section trivializes that underlying bundle and hence identifies a globally defined connection $(n-k+1)$ -form. This is the form ω_{Σ} in the above diagram.

Definition 4.4.132. For

$$\mathbf{L} : \mathbf{Fields} \rightarrow \mathbf{B}^n U(1)_{\text{conn}}$$

and $\Sigma_k \in \text{SmoothMds} \leftrightarrow \text{Smooth}\infty\text{Grpd}$ an oriented smooth manifold of dimension $k \leq n$ with boundary $\partial \Sigma_k$, we say that the *transgression* $\exp(\frac{i}{\hbar} \int_{\Sigma} \mathbf{L}_{\text{CS}})$ of \mathbf{L} to the mapping space out of Σ is the diagram obtained by composing the mapping space construction $[\Sigma, -] : \mathbf{H} \rightarrow \mathbf{H}$ with the fiber integration $\exp(\frac{i}{\hbar} \int_{\Sigma} (-))$ of Prop. 4.4.130:

$$\begin{array}{ccc}
& & [\Sigma_k, \mathbf{Fields}] \\
& \swarrow^{(-)|_{\partial \Sigma_k}} & \searrow^{[\Sigma_k, \nabla]} \\
[\partial \Sigma_k, \mathbf{Fields}] & & [\Sigma_k, \mathbf{B}^n U(1)_{\text{conn}}] \\
& \searrow^{[\partial \Sigma_k, \nabla]} & \swarrow^{(-)|_{\partial \Sigma}} \\
& & [\partial \Sigma_k, \mathbf{B}^n U(1)_{\text{conn}}] \\
& & \swarrow^{\exp(\frac{i}{\hbar} \int_{\Sigma} (-))} \\
& & \mathbf{B}^{n-k+1} U(1)_{\text{conn}} \\
& & \swarrow^{\exp(\frac{i}{\hbar} \int_{\partial \Sigma} (-))} \\
& & \Omega^{n-k+1}
\end{array}
\quad := \quad
\begin{array}{ccc}
& & [\Sigma_k, \mathbf{Fields}] \\
& \swarrow^{(-)|_{\partial \Sigma_k}} & \searrow^{[\Sigma_k, \nabla]} \\
[\partial \Sigma_k, \mathbf{Fields}] & & [\Sigma_k, \mathbf{B}^n U(1)_{\text{conn}}] \\
& \searrow^{[\partial \Sigma_k, \nabla]} & \swarrow^{(-)|_{\partial \Sigma}} \\
& & [\partial \Sigma_k, \mathbf{B}^n U(1)_{\text{conn}}] \\
& & \swarrow^{\exp(\frac{i}{\hbar} \int_{\Sigma} (-))} \\
& & \mathbf{B}^{n-k+1} U(1)_{\text{conn}} \\
& & \swarrow^{\exp(\frac{i}{\hbar} \int_{\partial \Sigma} (-))} \\
& & \Omega^{n-k+1}
\end{array}$$

Example 4.4.133. If $X \in \text{SmoothMfd} \hookrightarrow \text{Smooth}\infty\text{Grpd}$ is a smooth manifold and $\nabla : X \rightarrow \mathbf{B}^n U(1)_{\text{conn}}$ is an n -connection on X , and for Σ_n a closed oriented n -dimensional manifold, then the transgression

$$\exp\left(\frac{i}{\hbar} \int_{\Sigma} \nabla\right) : [\Sigma, X] \rightarrow U(1)$$

is the n -volume holonomy function of ∇ . For $n = 1$, hence ∇ is a $U(1)$ -principal connection, and $\Sigma = S^1$, this is the traditional notion of holonomy function of a principal connection along closed curves in X .

We now relate this construction to the abstract characterization of higher holonomy of def. 3.9.65

Theorem 4.4.134. *If $\Sigma \hookrightarrow \text{SmoothMfd} \hookrightarrow \text{Smooth}\infty\text{Grpd}$ is a closed manifold of dimension $\dim\Sigma \leq n$ then the intrinsic integration by truncation, def. 3.9.65, takes values in*

$$\tau_{\leq n - \dim\Sigma} \mathbf{H}(\Sigma, \mathbf{B}^n U(1)_{\text{conn}}) \simeq B^{n - \dim\Sigma} U(1) \simeq K(U(1), n - \dim(\Sigma)) \in \infty\text{Grpd}.$$

Moreover, in the case $\dim\Sigma = n$, then the morphism

$$\exp(iS_{\mathbf{c}}(-)) : \mathbf{H}(\Sigma, A_{\text{conn}}) \rightarrow U(1)$$

is obtained from the Lagrangian $\mathbf{L}_{\mathbf{c}}$ by forming the volume holonomy of circle n -bundles with connection (fiber integration in Deligne cohomology)

$$S_{\mathbf{c}}(-) = \int_{\Sigma} L_{\mathbf{c}}(-).$$

Proof. Since $\dim\Sigma \leq n$ we have by prop. 4.4.50 that $H(\Sigma, {}_{\text{dR}}\mathbf{B}^{n+1}\mathbb{R}) \simeq H_{\text{dR}}^{n+1}(\Sigma) \simeq *$. It then follows by prop. 3.9.39 that we have an equivalence

$$\mathbf{H}_{\text{diff}}(\Sigma, \mathbf{B}^n U(1)) \simeq \mathbf{H}_{\text{flat}}(\Sigma, \mathbf{B}^n U(1)) =: \mathbf{H}(\Pi(\Sigma), \mathbf{B}^n U(1))$$

with the flat differential cohomology on Σ , and by the $(\Pi \dashv \text{Disc} \dashv \Gamma)$ -adjunction it follows that this is equivalently

$$\begin{aligned} \dots &\simeq \infty\text{Grpd}(\Pi(\Sigma), \Gamma\mathbf{B}^n U(1)) \\ &\simeq \infty\text{Grpd}(\Pi(\Sigma), B^n U(1)_{\text{disc}}), \end{aligned}$$

where $B^n U(1)_{\text{disc}}$ is an Eilenberg-MacLane space $\dots \simeq K(U(1), n)$. By prop. 4.4.27 we have under $|-| : \infty\text{Grpd} \simeq \text{Top}$ a weak homotopy equivalence $|\Pi(\Sigma)| \simeq \Sigma$. Therefore the cocycle ∞ -groupoid is that of ordinary cohomology

$$\dots \simeq C^n(\Sigma, U(1)).$$

By general abstract reasoning it follows that we have for the homotopy groups an isomorphism

$$\pi_i \mathbf{H}_{\text{diff}}(\Sigma, \mathbf{B}^n U(1)) \xrightarrow{\cong} H^{n-i}(\Sigma, U(1)).$$

Now we invoke the universal coefficient theorem. This asserts that the morphism

$$\int_{(-)} (-) : H^{n-i}(\Sigma, U(1)) \rightarrow \text{Hom}_{\text{Ab}}(H_{n-i}(\Sigma, \mathbb{Z}), U(1))$$

which sends a cocycle ω in singular cohomology with coefficients in $U(1)$ to the pairing map

$$[c] \mapsto \int_{[c]} \omega$$

sits inside an exact sequence

$$0 \rightarrow \text{Ext}^1(H_{n-i-1}(\Sigma, \mathbb{Z}), U(1)) \rightarrow H^{n-i}(\Sigma, U(1)) \rightarrow \text{Hom}_{\text{Ab}}(H_{n-i}(\Sigma, \mathbb{Z}), U(1)) \rightarrow 0,$$

But since $U(1)$ is an injective \mathbb{Z} -module we have

$$\mathrm{Ext}^1(-, U(1)) = 0.$$

This means that the integration/pairing map $\int_{(-)}(-)$ is an isomorphism

$$\int_{(-)}(-) : H^{n-i}(\Sigma, U(1)) \simeq \mathrm{Hom}_{\mathrm{Ab}}(H_{n-i}(\Sigma, \mathbb{Z}), U(1)).$$

For $i < (n - \dim\Sigma)$, the right hand is zero, so that

$$\pi_i \mathbf{H}_{\mathrm{diff}}(\Sigma, \mathbf{B}^n U(1)) = 0 \quad \text{for } i < (n - \dim\Sigma).$$

For $i = (n - \dim\Sigma)$, instead, $H_{n-i}(\Sigma, \mathbb{Z}) \simeq \mathbb{Z}$, since Σ is a closed $\dim\Sigma$ -manifold and so

$$\pi_{(n-\dim\Sigma)} \mathbf{H}_{\mathrm{diff}}(\Sigma, \mathbf{B}^n U(1)) \simeq U(1).$$

□

More generally, using fiber integration in Deligne hypercohomology as in [GoTe00], we get for compact oriented closed smooth manifolds Σ of dimension k a natural morphism

$$\exp(2\pi i \int_{\sigma} (-)) : [\Sigma, \mathbf{B}^n U(1)_{\mathrm{conn}}] \rightarrow \mathbf{B}^{n-k} U(1)_{\mathrm{conn}}.$$

4.4.19 Chern-Simons functionals

We discuss the realization of the intrinsic notion of Chern-Simons functionals, 3.9.11, in $\mathrm{Smooth}\infty\mathrm{Grpd}$.

The proof of theorem 4.4.134 shows that for $\dim\Sigma = n$ and $\exp(iL) : A_{\mathrm{conn}} \rightarrow \mathbf{B}^n U(1)_{\mathrm{conn}}$ an (Chern-Simons) Lagrangian, we may think of the composite

$$\exp(iS) : \mathbf{H}(\Sigma, A_{\mathrm{conn}}) \xrightarrow{\exp(iL)} \mathbf{H}(\Sigma, \mathbf{B}^n U(1)_{\mathrm{conn}}) \xrightarrow{\int_{[\Sigma]} (-)} U(1)$$

as being indeed given by integrating the Lagrangian over Σ in order to obtain the action

$$S(-) = \int_{\Sigma} L(-).$$

We consider precise versions of this statement in 5.5.

4.4.20 Prequantum geometry

We discuss the notion of cohesive prequantization, 3.9.13, realized in the model of smooth cohesion.

What is traditionally called (*geometric*) *prequantization* is the refinement of symplectic 2-forms to curvature 2-forms on line bundles with connection. Formally: for

$$H_{\mathrm{diff}}^2(X) \xrightarrow{\mathrm{curv}} \Omega_{\mathrm{int}}^2(X) \hookrightarrow \Omega_{\mathrm{cl}}^2(X)$$

the morphism that sends a class in degree-2 differential cohomology over a smooth manifold X to its curvature 2-form, geometric prequantization of some $\omega \in \Omega_{\mathrm{cl}}^2(X)$ is a choice of lift $\hat{\omega} \in H_{\mathrm{diff}}^2(X)$ through this morphism. One says that $\hat{\omega}$ is (the class of) a *prequantum line bundle* or *quantization line bundle* with connection for ω . See for instance [WeXu91].

By the curvature exact sequence for differential cohomology, prop. 4.4.86, a lift $\hat{\omega}$ exists precisely if ω is an *integral* differential 2-form. This is called the *quantization condition* on ω . If it is fulfilled, the group

of possible choices of lifts is the topological (for instance singular) cohomology group $H^1(X, U(1))$. Notice that the extra non-degeneracy condition that makes a closed 2-form a symplectic form does not appear in *prequantization*.

The concept of geometric prequantization has an evident generalization to closed forms of degree $n+1$ for any $n \in \mathbb{N}$. For $\omega \in \Omega_{\text{cl}}^{n+1}(X)$ a closed differential $(n+1)$ -form on a manifold X , a geometric prequantization is a lift of ω through the canonical morphism

$$H_{\text{diff}}^{n+1}(X) \xrightarrow{\text{curv}} \Omega_{\text{int}}^{n+1}(X) \hookrightarrow \Omega_{\text{cl}}^{n+1}(X) .$$

Since the elements of the higher differential cohomology group $H_{\text{diff}}^{n+1}(X)$ are classes of *circle n -bundles with connection* (equivalently *circle bundle $(n-1)$ -gerbes with connection*) on X , we may speak of such a lift as a *prequantum circle n -bundle*. Again, the lift exists precisely if ω is integral and the group of possible choices is $H^n(X, U(1))$. Higher geometric prequantization for $n=2$ has been considered in [Rog11a]. By the discussion in 4.4.16 we may consider circle n -bundles with connection not just over smooth manifolds, but over any smooth ∞ -groupoid (smooth ∞ -stack) and hence consider, generally, geometric prequantization of higher forms on higher smooth stacks.

This section draws from [FRS13b].

- 4.4.20.1 – n -Plectic manifolds and their Hamiltonian vector fields
- 4.4.20.2 – The L_∞ -algebra of local observables
- 4.4.20.3 – The Kostant-Souriau L_∞ -cocycle
- 4.4.20.4 – The Kostant-Souriau-Heisenberg L_∞ -extension
- 4.4.20.5 – Ordinary symplectic geometry and its prequantization;
- 4.4.20.6 – 2-Plectic geometry and its prequantization.

4.4.20.1 n -Plectic manifolds and their Hamiltonian vector fields In [BHR08] the following terminology has been introduced.

Definition 4.4.135. A *pre- n -plectic manifold* (X, ω) is a smooth manifold X equipped with a closed $(n+1)$ -form $\omega \in \Omega_{\text{cl}}^{n+1}(X)$. If the contraction map $\hat{\omega}: TX \rightarrow \Lambda^n T^*X$ is injective, then ω is called *non-degenerate* or *n -plectic* and (X, ω) is called an *n -plectic manifold*.

Example 4.4.136. For $n=1$ an n -plectic manifold is equivalently an ordinary symplectic manifold.

Example 4.4.137. Let G be a compact connected simple Lie group. Equipped with its canonical left invariant differential 3-form $\omega := \langle -, [-, -] \rangle$ this is a 2-plectic manifold.

Definition 4.4.138. Let (X, ω) be a pre- n -plectic manifold. If a vector field v and an $(n-1)$ -form H are related by

$$\iota_v \omega + dH = 0$$

then we say that v is a Hamiltonian field for H and that H is a Hamiltonian form for v .

Definition 4.4.139. We denote by

$$\text{Ham}^{n-1}(X) \subseteq \mathfrak{X}(X) \oplus \Omega^{n-1}(X)$$

the subspace of pairs (v, H) such that $\iota_v \omega + dH = 0$. We call this the space of *Hamiltonian pairs*. The image $\mathfrak{X}_{\text{Ham}}(X) \subseteq \mathfrak{X}(X)$ of the projection $\text{Ham}^{n-1}(X) \rightarrow \mathfrak{X}(X)$ is called the space of *Hamiltonian vector fields* of (X, ω) .

Remark 4.4.140. Given a pre- n -plectic manifold (X, ω) We have a short exact sequence of vector spaces

$$0 \rightarrow \Omega_{\text{cl}}^{n-1}(X) \rightarrow \text{Ham}^{n-1}(X) \rightarrow \mathfrak{X}_{\text{Ham}}(X) \rightarrow 0,$$

i.e., closed $(n-1)$ -forms are Hamiltonian, with zero Hamiltonian vector field.

Remark 4.4.141. It is immediate from the definition that Hamilton vector fields preserve the pre- n -plectic form ω , i.e., $\mathcal{L}_v \omega = 0$. Indeed, since ω is closed, we have $\mathcal{L}_v \omega = d\iota_v \omega = -d^2 H_v = 0$. Therefore the integration of a Hamiltonian vector field gives a diffeomorphism of X preserving the pre- n -plectic form: a *Hamiltonian n -plectomorphism*.

Lemma 4.4.142. *The subspace $\mathfrak{X}_{\text{Ham}}(X)$ is a Lie subalgebra of $\mathfrak{X}(X)$.*

Remark 4.4.143. Hamiltonian vector fields on a pre- n -plectic manifold (X, ω) are by definition those vector fields v such that $\iota_v \omega$ is exact. One may relax this condition and consider *symplectic vector fields* instead, i.e., those vector fields v such that $\iota_v \omega$ is closed. Then the arguments in Remark 4.4.141 and in Lemma 4.4.142 show that symplectic vector fields form a Lie subalgebra $\mathfrak{X}_{\text{symp}}(X)$ of $\mathfrak{X}(X)$ and that $\mathfrak{X}_{\text{symp}}(X) \subseteq \mathfrak{X}_{\text{Ham}}(X)$ is a Lie ideal.

Definition 4.4.144. Let (X, ω) be a pre- n -plectic manifold. A *prequantization* of (X, ω) is a lift

$$\begin{array}{ccc} & \mathbf{B}^n U(1)_{\text{conn}} & \\ \nabla \nearrow & & \downarrow F \\ X & \xrightarrow{\omega} & \Omega^{n+1}(-)_{\text{cl}}. \end{array}$$

We call the triple (X, ω, ∇) a prequantized pre- n -plectic manifold.

4.4.20.2 The L_∞ -algebra of local observables We consider now the Lie differentiation of the Quantomorphism ∞ -group of a pre-quantized n -plectic smooth manifold.

Definition 4.4.145. We call the Lie n -algebra $L_\infty(X, \omega)$ of def. 1.2.288 the *L_∞ -algebra of local observables* on (X, ω) .

Remark 4.4.146. The projection map of def. 4.4.139 uniquely extends to a morphism of L_∞ -algebras of the form

$$\begin{array}{ccc} L_\infty(X, \omega) & & \\ \downarrow \pi_L & , & \\ \mathfrak{X}_{\text{Ham}}(X) & & \end{array}$$

i.e., local observables of (X, ω) cover Hamiltonian vector fields. Below in 4.4.20.3 we turn to the classification of this map by an L_∞ -algebra cocycle.

Example 4.4.147. If $n = 1$ then (X, ω) is a pre-symplectic manifold and the chain complex underlying $L_\infty(X, \omega)$ is

$$\text{Ham}^0(X) = \{v + H \in \mathfrak{X}(X) \oplus C^\infty(X; \mathbb{R}) \mid \iota_v \omega + dH = 0\},$$

and the Lie bracket is

$$[v_1 + H_1, v_2 + H_2] = [v_1, v_2] + \iota_{v_1} \wedge v_2 \omega.$$

If moreover ω is non-degenerate so that (X, ω) is symplectic, then the projection $v + H \mapsto H$ is a linear isomorphism $\text{Ham}^0(X) \xrightarrow{\cong} C^\infty(X; \mathbb{R})$. It is easy to see that under this isomorphism $L_\infty(X, \omega)$ is the underlying Lie algebra of the usual Poisson algebra of functions. See also Prop. 2.3.9 in [Br93].

4.4.20.3 The Kostant-Souriau L_∞ -cocycle

Definition 4.4.148. For X a smooth manifold, denote by $\mathbf{BH}(X, \mathfrak{b}\mathbf{B}^{n-1}\mathbb{R})$ the abelian Lie $(n+1)$ -algebra given by the chain complex

$$\Omega^0(X) \xrightarrow{d} \Omega^1(X) \xrightarrow{d} \dots \xrightarrow{d} \Omega^{n-1}(X) \xrightarrow{d} d\Omega^{n-1}(X),$$

with $d\Omega^{n-1}(X)$ in degree zero.

Remark 4.4.149. The complex of def. 4.4.148 serves as a resolution of the cocycle complex

$$\Omega^0(X) \xrightarrow{d} \Omega^1(X) \xrightarrow{d} \dots \xrightarrow{d} \Omega_{\text{cl}}^{n-1}(X) \rightarrow 0,$$

for the de Rham cohomology of X up to degree $n-1$ once delooped (i.e., shifted).

Proposition 4.4.150. *Let (X, ω) be a pre- n -plectic manifold. The multilinear maps*

$$\omega_{[1]} : v \mapsto -\iota_v \omega; \quad \omega_{[2]} : v_1 \wedge v_2 \mapsto \iota_{v_1} \wedge v_2 \omega; \quad \dots \quad \omega_{[n+1]} : v_1 \wedge v_2 \wedge \dots \wedge v_{n+1} \mapsto -(-1)^{\binom{n+1}{2}} \iota_{v_1 \wedge v_2 \wedge \dots \wedge v_{n+1}} \omega$$

define an L_∞ -morphism

$$\omega_{[\bullet]} : \mathfrak{X}_{\text{Ham}}(X) \rightarrow \mathbf{BH}(X, \mathfrak{b}\mathbf{B}^{n-1}\mathbb{R}),$$

and hence an L_∞ -algebra $(n+1)$ -cocycle on the Lie algebra of Hamiltonian vector fields, def. 4.4.139, with values in the abelian $(n+1)$ -algebra of def. 4.4.148.

This is due to [FRS13b].

Definition 4.4.151. The degree $(n+1)$ higher Kostant-Souriau L_∞ -cocycle associated to the pre- n -plectic manifold (X, ω) is the L_∞ -morphism

$$\omega_{[\bullet]} : \mathfrak{X}_{\text{Ham}}(X) \longrightarrow \mathbf{BH}(X, \mathfrak{b}\mathbf{B}^{n-1}\mathbb{R})$$

given in Prop. 4.4.150.

If $\rho : \mathfrak{g} \rightarrow \mathfrak{X}_{\text{Ham}}(X)$ is an L_∞ -morphism encoding an action of an L_∞ -algebra \mathfrak{g} on (X, ω) by Hamiltonian vector fields, then we call the composite $\rho^* \omega_{[\bullet]}$ the corresponding *Heisenberg L_∞ -algebra cocycle*. This terminology is motivated by example 4.4.152 below.

Example 4.4.152. Let V be a vector space equipped with a skew-symmetric multilinear form $\omega : \Lambda^{n+1}V \rightarrow \mathbb{R}$. Since V is an abelian Lie group, we obtain via left-translation of ω a unique closed invariant form, which we also denote as ω . By identifying V with left-invariant vector fields on V , the Poincaré lemma implies that we have a canonical inclusion

$$j_V : V \hookrightarrow \mathfrak{X}_{\text{Ham}}(V)$$

of V regarded as an abelian Lie algebra into the Hamiltonian vector fields on (V, ω) regarded as a pre- n -plectic manifold. Since V is contractible as a topological manifold, we have, by remark 4.4.149, a quasi-isomorphism

$$\mathbf{BH}(V; \mathfrak{b}\mathbf{B}^{n-1}\mathbb{R}) \xrightarrow{\simeq} \mathbb{R}[n]$$

of abelian L_∞ -algebras, given by evaluation at 0. Under this equivalence the restriction of the L_∞ -algebra cocycle $\omega_{[\bullet]}$ of def. 4.4.151 along j_V is an L_∞ -algebra map of the form

$$j_V^* \omega_{[\bullet]} : V \longrightarrow \mathbb{R}[n]$$

whose single component is the linear map

$$\iota_{(-)} \omega : \Lambda^{n+1}V \rightarrow \mathbb{R}.$$

For $n=1$ and (V, ω) an ordinary symplectic vector space the map $\iota_{(-)} \omega : V \wedge V \rightarrow \mathbb{R}$ is the traditional *Heisenberg cocycle*.

4.4.20.4 The Kostant-Souriau-Heisenberg L_∞ -extension We consider here the cohesive quantomorphism and Heisenberg group extensions from 3.9.13.5 after Lie differentiation as extensions of L_∞ -algebras.

Proposition 4.4.153. *If (X, ω) is a pre- n -plectic manifold, then the projection map $\pi_L: L_\infty(X, \omega) \rightarrow \mathfrak{X}_{\text{Ham}}(X)$ (remark 4.4.146) and the higher Kostant-Souriau L_∞ -cocycle $\omega_{[\bullet]}$ (def. 4.4.151) form a homotopy fiber sequence of L_∞ -algebras, and hence fit into a homotopy pullback diagram of the form*

$$\begin{array}{ccc} L_\infty(X, \omega) & \longrightarrow & 0 \\ \downarrow \pi_L & & \downarrow \\ \mathfrak{X}_{\text{Ham}}(X) & \xrightarrow{\omega_{[\bullet]}} & \mathbf{BH}(X, \mathfrak{b}\mathbf{B}^{n-1}\mathbb{R}). \end{array}$$

This is due to [FRS13b]

If a Lie algebra \mathfrak{g} acts on an n -plectic manifold by Hamiltonian vector fields, then the Kostant-Souriau L_∞ -extension of $\mathfrak{X}_{\text{Ham}}(X)$, discussed above in 4.4.20.4, restricts to an L_∞ -extension of \mathfrak{g} . This is a generalization of Kostant's construction [Kos70] of central extensions of Lie algebras to the context of L_∞ -algebras. Perhaps the most famous of these central extensions is the Heisenberg Lie algebra, which is the inspiration behind the following terminology:

Definition 4.4.154. Let (X, ω) be a pre- n -plectic manifold and let $\rho: \mathfrak{g} \rightarrow \mathfrak{X}_{\text{Ham}}(X)$ be a Lie algebra homomorphism encoding an action of \mathfrak{g} on X by Hamiltonian vector fields. The corresponding *Heisenberg L_∞ -algebra extension* $\mathfrak{heis}_\rho(\mathfrak{g})$ of \mathfrak{g} is the extension classified by the composite L_∞ -morphism $\omega_{[\bullet]} \circ \rho$, i.e. the homotopy pullback on the left of

$$\begin{array}{ccccc} \mathfrak{heis}_\rho(\mathfrak{g}) & \longrightarrow & L_\infty(X, \omega) & \longrightarrow & 0 \\ \downarrow & & \downarrow & & \downarrow \\ \mathfrak{g} & \xrightarrow{\rho} & \mathfrak{X}_{\text{Ham}}(X) & \xrightarrow{\omega_{[\bullet]}} & \mathbf{BH}(X, \mathfrak{b}\mathbf{B}^{n-1}\mathbb{R}) \end{array}$$

Remark 4.4.155. It is natural to call an L_∞ -morphism with values in the L_∞ -algebra of observables of a pre- n -plectic manifold (X, ω) an ' L_∞ co-moment map', which generalizes the familiar notion in symplectic geometry. Hence, one could say that an action ρ of a Lie algebra \mathfrak{g} on a pre- n -plectic manifold (X, ω) via Hamiltonian vector fields naturally induces such a co-moment map from the Heisenberg L_∞ -algebra $\mathfrak{heis}_\rho(\mathfrak{g})$.

4.4.20.5 Ordinary symplectic geometry and its prequantization We discuss how the general abstract notion of higher geometric prequantization reduces to the traditional notion of geometric prequantization when interpreted in the smooth context and for $n = 1$.

The following is essentially a re-derivation of the discussion in section II.3 and II.4 of [Br93] (based on [Kos70]) from the abstract point of view of 3.9.13.

The traditional definition of Hamiltonian vector fields is the following.

Definition 4.4.156. Let (X, ω) be a smooth symplectic manifold. A *Hamiltonian vector field* on X is a vector field $v \in \Gamma(TX)$ whose contraction with the symplectic form ω yields an exact form, hence such that

$$\exists h \in C^\infty(X) : \iota_v \omega = d_{\text{dR}} h.$$

Here a choice of function h is called a *Hamiltonian* for v .

Proposition 4.4.157. *Let X be a smooth manifold which is simply connected, and let $\omega \in \Omega^2(X)_{\text{int}}$ be an integral symplectic form on X . Then regarding (X, ω) as a symplectic 0-groupoid in $\text{Smooth}\infty\text{Grpd}$, the general definition 3.9.97 reproduces the standard notion of Hamiltonian vector fields, def. 4.4.156 on the symplectic manifold (X, ω) .*

Proof. A Hamiltonian symplectomorphism is an equivalence $\phi : X \rightarrow X$ that fits into a diagram

$$\begin{array}{ccc} X & \xrightarrow{\phi} & X \\ & \searrow \hat{\omega} & \swarrow \hat{\omega} \\ & & \mathbf{BU}(1)_{\text{conn}} \end{array}$$

α

in $\text{Smooth}\infty\text{Grpd}$. To compute the Lie algebra of the group of these diffeomorphisms, we need to consider smooth 1-parameter families of such and differentiate them.

Assume first that the connection 1-form in $\hat{\omega}$ is globally defined $A \in \Omega^1(X)$ with $dA = \omega$. Then the existence of the above diagram is equivalent to the condition

$$(\phi(t))^* A - A = d\alpha(t),$$

where $\alpha(t) \in C^\infty(X)$. Differentiating this at 0 yields the Lie derivative

$$\mathcal{L}_v A = d\alpha',$$

where v is the vector field of which $t \mapsto \phi(t)$ is the flow and where $\alpha' := \frac{d}{dt}\alpha$. By Cartan calculus this is equivalently

$$d_{\text{dR}}\iota_v A + \iota_v d_{\text{dR}} A = d\alpha'$$

and using that A is the connection on a prequantum circle bundle for ω

$$\iota_v \omega = d(\alpha' - \iota_v A).$$

This says that for v to be Hamiltonian, its contraction with ω must be exact. This is precisely the definition of Hamiltonian vector fields. The corresponding Hamiltonian function h here is $\alpha' - \iota_v A$.

We now discuss the general case, where the prequantum bundle is not necessarily trivial. After a choice of cover that is compatible with the flows of vector fields, the argument proceeds by slight generalization of the previous argument.

We may assume without restriction of generality that X is connected. Choose then any base point $x_0 \in X$ and let

$$P_* X := [I, X] \times_X \{x_0\}$$

be the based smooth path space of X , regarded as a diffeological space, def. 4.4.14, where $I \subset \mathbb{R}$ is the standard closed interval. This comes equipped with the smooth endpoint evaluation map

$$p : P_* X \rightarrow X.$$

Pulled back along this map, every circle bundle has a trivialization, since $P_* X$ is topologically contractible. The corresponding Čech nerve $C(P_* X \rightarrow X)$ is the simplicial presheaf that starts out as

$$\cdots \rightrightarrows P_* X \times_X P_* X \begin{array}{c} \xrightarrow{p_1} \\ \xrightarrow{p_2} \end{array} P_* X,$$

where in first degree we have a certain smooth version of the based loop space of X . Any diffeomorphism $\phi = \exp(v) : X \rightarrow X$ lifts to an automorphism of the Čech nerve by letting

$$P_* \phi : P_* X \rightarrow P_* X$$

be given by

$$P_* \phi(\gamma) : (t \in [0, 1]) \mapsto \exp(tv)(\gamma(t))$$

and similarly for $P_* \phi : P_* X \times_X P_* X \rightarrow P_* X \times_X P_* X$. If $\phi = \exp(tv)$ for v a vector field on X , we will write v also for the vector fields induced this way on the components of the Čech nerve.

With these preparations, every elements of the group in question is presented by a diagram of simplicial presheaves of the form

$$\begin{array}{ccc}
 C(P_*X \rightarrow X) & \xrightarrow{P_*\phi} & C(P_*X \rightarrow X) . \\
 & \swarrow \hat{\omega} \quad \searrow \alpha & \\
 & \mathbf{BU}(1)_{\text{conn}} &
 \end{array}$$

Here the vertical (diagonal) morphisms now exhibit Čech-Deligne cocycles with transition function

$$g \in C^\infty(P_*X \times_X P_*X)$$

and connection 1-form

$$A \in \Omega^1(P_*X),$$

satisfying

$$p_2^*A - p_1^*A = d_{\text{dR}} \log g .$$

For $\phi(t) = \exp(tv)$ a 1-parameter family of diffeomorphisms, the homotopy in this diagram is a gauge transformation given by a function $\alpha(t) \in C^\infty(P_*X, U(1))$ such that

$$p_2^*\alpha(t) \cdot g \cdot p_1^*\alpha(t)^{-1} = \exp(tv)^*g$$

and

$$\exp(tv)^*A - A = d_{\text{dR}} \log \alpha(t) .$$

Differentiating this at $t = 0$ and writing $\alpha' := \alpha'(0)$ as before, this yields

$$p_2^*\alpha' - p_1^*\alpha' = \mathcal{L}_v \log g$$

and

$$\mathcal{L}_v A = d_{\text{dR}} \alpha' .$$

The latter formula says that on P_*X $\iota_v \omega$ is exact

$$\iota_v p^* \omega = d_{\text{dR}}(\alpha' - \iota_v A) .$$

But in fact the function on the right descends down to X , because by the formulas above we have

$$\begin{aligned}
 p_2^*(\alpha' - \iota_v A) - p_1^*(\alpha' - \iota_v A) &= \mathcal{L}_v \log g - \iota_v(p_2^*A - p_1^*A) \\
 &= 0 .
 \end{aligned}$$

Write therefore $h \in C^\infty(X)$ for the unique function such that $p^*h = \alpha' - \iota_v A$, then this satisfies

$$\iota_v \omega = dh$$

on X . □

The traditional definition of the Poisson-bracket Lie algebra associated with a symplectic manifold (X, ω) is the following.

Definition 4.4.158. Let (X, ω) be a smooth symplectic manifold. Then its *Poisson-bracket Lie algebra* is the Lie algebra whose underlying vector space is $C^\infty(X)$, the space of smooth function on X , and whose Lie bracket is given by

$$[h_1, h_2] := \iota_{v_2} \iota_{v_1} \omega$$

for all $h_1, h_2 \in C^\infty(X)$ and for v_1, v_2 the corresponding Hamiltonian vector fields, def. 4.4.156.

Proposition 4.4.159. *The general definition of Poisson ∞ -Lie algebra, def. 3.9.97, applied to the symplectic manifold (X, ω) regarded as a symplectic smooth 0-groupoid, reproduces the traditional definition of the Lie algebra underlying the Poisson algebra of (X, ω) .*

Proof. The smooth group $\mathbf{Aut}_{\mathbf{H}/BU(1)_{\text{conn}}}(\hat{\omega})$ is manifestly a subgroup of the semidirect product group $\text{Diff}(X) \times C^\infty(X)$, where the group structure on the second factor is given by addition, and the action of the first factor on the second is the canonical one by pullback. Accordingly, its Lie algebra may be identified with that of pairs (v, α) in $\Gamma(TX) \times C^\infty(X)$ such that, with the notation as in the proof of prop. 4.4.157, $\alpha - \iota_v A$ is a Hamiltonian for v ; and the Lie bracket is given by

$$[(v_1, \alpha_1), (v_2, \alpha_2)] = ([v_1, v_2], \mathcal{L}_{v_2} \alpha_1 - \mathcal{L}_{v_1} \alpha_2).$$

Notice that these pairs are redundant in that v is entirely determined by α , we just use them to make explicit the embedding into the semidirect product.

It remains to check that with this bracket the map

$$\phi : \alpha \mapsto \alpha - \iota_v A$$

is a Lie algebra isomorphism to the Poisson-bracket Lie algebra, def. 4.4.158. For this first notice the equation

$$\begin{aligned} 2\iota_{v_2} \iota_{v_1} \omega &= \iota_{v_2} d_{\text{dR}} h_1 - \iota_{v_1} d_{\text{dR}} h_2 \\ &= \mathcal{L}_{v_2}(\alpha_1 - \iota_{v_1} A) - \mathcal{L}_{v_1}(\alpha_2 - \iota_{v_2} A) \\ &= \mathcal{L}_{v_2} \alpha_1 - \mathcal{L}_{v_1} \alpha_2 + \iota_{v_2} \iota_{v_1} d_{\text{dR}} A - \iota_{[v_1, v_2]} A, \end{aligned}$$

where in the last step we used the identity

$$\iota_{v_2} \iota_{v_1} d_{\text{dR}} A = \mathcal{L}_{v_1} \iota_{v_2} A - \mathcal{L}_{v_2} \iota_{v_1} A - \iota_{[v_1, v_2]} A.$$

Subtracting $\iota_{v_2} \iota_{v_1} \omega = \iota_{v_2} \iota_{v_1} d_{\text{dR}} A$ on both sides yields

$$[h_1, h_2] = \mathcal{L}_{v_2} \alpha_1 - \mathcal{L}_{v_1} \alpha_2 - \iota_{[v_1, v_2]} A.$$

This is equivalently the equation

$$\begin{aligned} [\phi(\alpha_1), \phi(\alpha_2)] &= \mathcal{L}_{v_2} \alpha_1 - \mathcal{L}_{v_1} \alpha_2 - \iota_{[v_1, v_2]} A, \\ &= \phi([\alpha_1, \alpha_2]), \end{aligned}$$

which exhibits ϕ as a Lie algebra homomorphism. □

We recover the following traditional facts from the general notions of 3.9.13.

Observation 4.4.160. The *Poisson-bracket group* of the symplectic manifold $(X, \hat{\omega})$ according to def. 3.9.97 is a central extension by $U(1)$ of the group of hamiltonian symplectomorphisms: we have a short exact sequence of smooth groups

$$U(1) \rightarrow \text{Poisson}(X, \hat{\omega}) \rightarrow \text{HamSymp}(X, \hat{\omega}).$$

On Lie algebras this exhibits the Poisson-bracket Lie algebra as a central extension of the Lie algebra of Hamiltonian vector fields.

$$\mathbb{R} \rightarrow \mathfrak{poisson}(X, \hat{\omega}) \rightarrow \mathcal{X}_{\text{ham}}(X, \hat{\omega}).$$

If (X, ω) is a *symplectic vector space* in that X is a vector space and the symplectic differential form ω is constant with respect to (left or right) translation along X , then the *Heisenberg Lie algebra* is the sub Lie algebra

$$\mathfrak{heis}(X, \hat{\omega}) \hookrightarrow \mathfrak{poisson}(X, \hat{\omega})$$

on the constant and the linear functions, see remark 3.9.98.

Traditional literature knows different conventions about which Lie group to pick by default as the one integrating a Heisenberg Lie algebra (the unique simply-connected one or one of its discrete quotients). By remark 3.9.98 the inclusion

$$\text{Heis}(X, \hat{\omega}) \hookrightarrow \text{Poisson}(X, \hat{\omega})$$

picks the one where the central part is integrated to the circle group:

$$\text{Heis}(X, \hat{\omega}) \simeq X \times U(1).$$

If in this decomposition we write the canonical generator in

$$\mathfrak{heis}(X, \hat{\omega}) \simeq X \oplus \mathfrak{u}(1)$$

of the summand $\mathfrak{u}(1) = \text{Lie}(U(1))$ as “i” then the Lie bracket on $\mathfrak{heis}(X, \hat{\omega})$ is given on any two $f, g \in X$ by

$$[f, g] = i\omega(f, g).$$

Specifically for the special case $X = \mathbb{R}^2$ with canonical basis vectors denoted \hat{q} and \hat{p} , and with ω the canonical symplectic form, the only nontrivial bracket in $\mathfrak{heis}(X, \hat{\omega})$ among these generators is

$$[\hat{q}, \hat{p}]_{\mathfrak{heis}} = i.$$

The image of this equation under the map $\mathfrak{heis}(X, \hat{\omega}) \rightarrow \mathcal{X}_{\text{Ham}}(X, \hat{\omega})$ is

$$[q, p]_{\mathcal{X}} = 0,$$

where now q, p denote the Hamiltonian vector fields associated with \hat{q} and \hat{p} , respectively. The lift from the latter to the former equation is, historically, the archetypical hallmark of quantization.

Proposition 4.4.161. *For (X, ω) an ordinary prequantizable symplectic manifold and $\nabla : X \rightarrow \mathbf{B}^1U(1)$ any choice of prequantum bundle, def. 3.9.77, let $V := \mathbb{C}$ and let ρ be the canonical representation of $U(1)$.*

Then def. 3.9.103 reduces to the traditional definition to prequantum operators in geometric quantization.

Proof. According to the discussion in 5.2.2 the space of sections $\Gamma_X(E)$ is that of the ordinary sections of the ordinary associated line bundle.

Notice that part of the statement there is that the standard presentation of $\rho : V//U(1) \rightarrow \mathbf{B}U(1)$ by a morphism of simplicial presheaves $V//U(1)_{\text{ch}} \rightarrow \mathbf{B}G_{\text{ch}}$ is a fibration. In particular this means, as used there, that the ∞ -groupoid of sections *up to homotopy* is presented already by the Kan complex (which here is just a set) of strict sections σ

$$\begin{array}{ccc} & & V//U(1)_{\text{ch}} \\ & \nearrow \sigma & \downarrow \rho \\ C(\{U_i\}) & \xrightarrow{c} & \mathbf{B}G_{\text{ch}} \\ \downarrow \simeq & & \\ X & & \end{array}$$

and it is these that directly identify with the ordinary sections of the line bundle $E \rightarrow X$.

Now, a Hamiltonian diffeomorphism in the general sense of def. 3.9.103 takes such a section σ to the pasting composite

$$\begin{array}{ccc} & & V//U(1)_{\text{conn}} \\ & \nearrow \sigma & \downarrow \rho_{\text{conn}} \\ X & \xrightarrow{\phi} & X \\ & \searrow \alpha & \downarrow \nabla \\ X & \xrightarrow{\nabla} & \mathbf{B}U(1)_{\text{conn}} \end{array}$$

By the above, to identify this with a section of the line bundle in the ordinary sense, we need to find an equivalent homotopy-section whose homotopy is, however, trivial, hence a strict section which is equivalent to this as a homotopy section.

Inspection shows that there is a unique such equivalence whose underlying natural transformations has components induced by the inverse of α . Then for $h : X \rightarrow \mathbb{C}$ a given function and $t \mapsto (\phi(t), \alpha(t))$ the family of Hamiltonian diffeomorphism associated to it by prop. 4.4.157, the proof of that proposition shows that the infinitesimal difference between the original section σ and this new section is

$$i\nabla_{v_h}\sigma + h \cdot \sigma,$$

where v_h is the ordinary Hamiltonian vector field induced by h . This is the traditional formula for the action of the prequantum operator \hat{h} on prequantum states. \square

4.4.20.6 2-Plectic geometry and its prequantization We consider now the general notion of higher geometric prequantization, 3.9.13, specialized to the case of closed 3-forms on smooth manifolds, canonically regarded in $\text{Smooth}\infty\text{Grpd}$. We show that this reproduces the *2-plectic geometry* and its prequantization studied in [Rog11a].

The following two definitions are from [Rog11a], def. 3.1, prop. 3.15.

Definition 4.4.162. A *2-plectic structure* on a smooth manifold X is a smooth closed differential 3-form $\omega \in \Omega_{\text{cl}}^3(X)$, which is non-degenerate in that the induced morphism

$$\iota_{(-)}\omega : \Gamma(TX) \rightarrow \Omega^2(X)$$

has trivial kernel.

Definition 4.4.163. Let (X, ω) be a 2-plectic manifold. Then a 1-form $h \in \Omega^1(X)$ is called *Hamiltonian* if there exists a vector field $v \in \Gamma(TX)$ such that

$$d_{\text{dR}}h = \iota_v\omega.$$

If this vector field exists, then it is unique and is called the *Hamiltonian vector field* corresponding to α . We write v_h to indicate this. We write

$$\Omega^1(X)_{\text{Ham}} \hookrightarrow \Omega^1(X)$$

for the vector space of Hamiltonian 1-forms on (X, ω) .

The *Lie 2-algebra of Hamiltonian vector fields* $L_\infty(X, \omega)$ is the (infinite-dimensional) L_∞ -algebra, def. 1.2.143, whose underlying chain complex is

$$\cdots \longrightarrow 0 \longrightarrow C^\infty(X) \xrightarrow{d_{\text{dR}}} \Omega_{\text{Ham}}^1(X),$$

whose non-trivial binary bracket is

$$[-, -] : (h_1, h_2) \mapsto \iota_{v_{h_2}}\iota_{v_{h_1}}\omega$$

and whose non-trivial ternary bracket is

$$[-, -, -] : (h_1, h_2, h_3) \mapsto \iota_{v_{h_1}}\iota_{v_{h_2}}\iota_{v_{h_3}}\omega.$$

Proposition 4.4.164. *Let (X, ω) be a 2-plectic smooth manifold, canonically regarded in $\text{Smooth}\infty\text{Grpd}$. Then for $\hat{\omega} : X \rightarrow \mathbf{B}^2U(1)_{\text{conn}}$ any prequantum circle 2-bundle with connection (see 4.4.16) for ω , its Poisson Lie 2-algebra, def. 3.9.97, is equivalent to the Lie 2-algebra $L_\infty(X, \omega)$ from def. 4.4.163:*

$$\text{poisson}(X, \hat{\omega}) \simeq L_\infty(X, \omega).$$

Proof. As in the proof of prop. 4.4.157, we first consider the case that ω is exact, so that there exists a globally defined 2-form $A \in \Omega^2(X)$ with $d_{\text{dR}}A = \omega$. The general case follows from this by working on the path fibration surjective submersion, in straightforward generalization of the strategy in the proof of prop. 4.4.157.

By def. 3.9.97, an object of the smooth 2-group $\text{Poisson}(X, \hat{\omega})$ is a diagram of smooth 2-groupoids

$$\begin{array}{ccc} X & \xrightarrow{\phi} & X \\ & \searrow A & \swarrow A \\ & \mathbf{B}^2U(1)_{\text{conn}} & \end{array} \quad , \quad \begin{array}{c} \alpha \\ \longleftarrow \end{array}$$

such that map ϕ is a diffeomorphism. Given ϕ , such diagrams correspond to $\alpha \in \Omega^1(X)$ such that

$$(\phi^*A - A) = d_{\text{dR}}\alpha . \quad (4.1)$$

Morphisms in the 2-group may go between two such objects $(f) : (\phi, \alpha_1) \rightarrow (\phi, \alpha_2)$ with the same ϕ and are given by $f \in C^\infty(X, U(1))$ such that

$$\alpha_2 = \alpha_1 + d_{\text{dR}}\log f .$$

Under the 2-group product the objects (ϕ, α) form a genuine group with multiplication given by

$$(\phi_1, \alpha_1) \cdot (\phi_2, \alpha_2) = (\phi_2 \circ \phi_1, \alpha_1 + \phi_1^*\alpha_2) .$$

Similarly the group product on two morphisms $(f_1), (f_2) : (\phi, \alpha_1) \rightarrow (\phi, \alpha_2)$ is given by

$$(f_1) \cdot (f_2) = f_1 \cdot \phi^* f_2 .$$

Therefore this is a *strict* 2-group, def. 1.2.74, given by the subobject of the crossed module

$$C^\infty(X, U(1)) \xrightarrow{(0, d_{\text{dR}}\log)} \text{Diff}(X) \ltimes \Omega^1(X)$$

on those pairs of vector fields and 1-forms that satisfy (4.1). Here $\text{Diff}(X) \ltimes \Omega^1(X)$ is the semidirect product group induced by the pullback action on the additive group of 1-forms, and its action on $C^\infty(X, U(1))$ is again by the pullback action of the $\text{Diff}(X)$ -factor.

Therefore the L_∞ -algebra $\text{poisson}(X, \hat{\omega})$ may be identified with the subobject of the corresponding strict Lie 2-algebra given by the differential crossed module, def. 1.2.75,

$$C^\infty(X) \xrightarrow{d_{\text{dR}}} \Gamma(TX) \oplus \Omega^1(X)$$

on those pairs $(v, \alpha) \in \Gamma(TX) \times \Omega^1(X)$ for which

$$\mathcal{L}_v A = d_{\text{dR}}\alpha ,$$

hence, by Cartan's formula, for which

$$h := \alpha - \iota_v A$$

is a Hamiltonian 1-form for v , def. 4.4.163. Here $\Gamma(TX) \oplus \Omega^1(X)$ is the semidirect product Lie algebra with bracket

$$[(v_1, \alpha_1), (v_2, \alpha_2)] = ([v_1, v_2], \mathcal{L}_{v_2}\alpha_1 - \mathcal{L}_{v_1}\alpha_2)$$

and its action on $f \in C^\infty(X)$ is by Lie derivatives of the $\Gamma(TX)$ -summand:

$$[(v, \alpha), f] = -\mathcal{L}_v f .$$

For emphasis, we write $\Omega_{\text{Ham},p}^1 \subset \Gamma(TX) \oplus \Omega^1(X)$ for the vector space of pairs (v, α) with $\alpha - \iota_v A$ Hamiltonian. The map $\phi : (\alpha, v) \mapsto \alpha - \iota_v A$ constitutes a vector space isomorphism

$$\phi : \Omega_{\text{Ham},p}^1 \xrightarrow{\cong} \Omega_{\text{Ham}}^1$$

and for the moment it is useful to keep this around explicitly. So $\mathfrak{poisson}(X, \hat{\omega})$ is given by the differential crossed module on the top of the diagram

$$\begin{array}{ccc} C^\infty(X) & \xrightarrow{d_{\text{dR}}} & \Omega_{\text{Ham},p}^1(X) \\ \downarrow = & & \downarrow \\ C^\infty(X) & \xrightarrow{d_{\text{dR}}} & \Gamma(TX) \oplus \Omega^1(X) \end{array},$$

with brackets induced by this inclusion into the crossed module on the bottom.

We need to check that with these brackets the chain map

$$\begin{array}{ccc} C^\infty(X) & \xrightarrow{\text{id}} & C^\infty(X) \\ \downarrow d_{\text{dR}} & & \downarrow d_{\text{dR}} \\ \Omega^1(X)_{\text{Ham},p} & \xrightarrow{\phi} & \Omega^1(X)_{\text{Ham}} \end{array}$$

$$[-, -] \quad \quad \quad ([-, -]', J)$$

is a Lie 2-algebra equivalence from the strict brackets $[-, -]$ to the brackets $([-, -]', [-, -, -]')$ of def. 4.4.163.

To that end, first notice the equation

$$\begin{aligned} 2\iota_{v_2}\iota_{v_1}\omega &= \iota_{v_2}d_{\text{dR}}h_1 - \iota_{v_1}d_{\text{dR}}h_2 \\ &= \mathcal{L}_{v_2}(\alpha_1 - \iota_{v_1}A) - \mathcal{L}_{v_1}(\alpha_2 - \iota_{v_2}A) + d_{\text{dR}}(\iota_{v_1}h_2 - \iota_{v_2}h_1) \\ &= \mathcal{L}_{v_2}\alpha_1 - \mathcal{L}_{v_1}\alpha_2 + \iota_{v_2}\iota_{v_1}d_{\text{dR}}A - \iota_{[v_1, v_2]}A + d_{\text{dR}}(\iota_{v_1}h_2 - \iota_{v_2}h_1 - \iota_{v_2}\iota_{v_1}A), \end{aligned}$$

where in the last step we used the identity

$$\iota_{v_2}\iota_{v_1}d_{\text{dR}}A = \mathcal{L}_{v_1}\iota_{v_2}A - \mathcal{L}_{v_2}\iota_{v_1}A - \iota_{[v_1, v_2]}A + d_{\text{dR}}\iota_{v_2}\iota_{v_1}A.$$

Subtracting $\iota_{v_2}\iota_{v_1}\omega = \iota_{v_2}\iota_{v_1}d_{\text{dR}}A$ on both sides yields

$$\iota_{v_2}\iota_{v_1}\omega = \mathcal{L}_{v_2}\alpha_1 - \mathcal{L}_{v_1}\alpha_2 - \iota_{[v_1, v_2]}A + d_{\text{dR}}(\iota_{v_1}h_2 - \iota_{v_2}h_1 - \iota_{v_2}\iota_{v_1}A),$$

Here on the left we have the bracket of h_1 with h_2 in def. 4.4.163, which we will write $[h_1, h_2]' := [\phi(v_1, \alpha_1), \phi(v_2, \alpha_2)]'$, whereas the first three terms on the right are the image under ϕ of the bracket from above, to be written $\phi[(v_1, \alpha_1), (v_2, \alpha_2)]$. Therefore this equation says that

$$[\phi(v_1, \alpha_1), \phi(v_2, \alpha_2)]' = \phi([(v_1, \alpha_1), (v_2, \alpha_2)]) + d_{\text{dR}}(\iota_{v_1}\phi(v_2, \alpha_2) - \iota_{v_2}\phi(v_1, \alpha_1) - \iota_{v_2}\iota_{v_1}A). \quad (4.2)$$

In view of the exact term on the far right, this implies that the map

$$\Phi : \Omega^1(X)_{\text{Ham}} \otimes \Omega^1(X)_{\text{Ham},p} \rightarrow C^\infty(X)$$

given by

$$\Phi : (h_1 = \alpha_1 - \iota_{v_1}A, h_2 = \alpha_2 - \iota_{v_2}A) \mapsto \iota_{v_1}h_2 - \iota_{v_2}h_1 - \iota_{v_2}\iota_{v_1}A$$

should be a chain homotopy between the binary brackets

$$\begin{array}{ccc}
(\Omega^1(X)_{\text{Ham},p} \otimes C^\infty(X)) \oplus (C^\infty(X) \otimes \Omega^1(X)_{\text{Ham},p}) & \xrightarrow{[-,-]' - [-,-]} & C^\infty(X) \\
\downarrow (\text{id} \otimes d_{\text{dR}}) \oplus (d_{\text{dR}} \otimes \text{id}) & \searrow \Phi & \downarrow d_{\text{dR}} \\
\Omega^1(X)_{\text{Ham},p} \otimes \Omega^1(X)_{\text{Ham},p} & \xrightarrow{[\phi(-), \phi(-)]' - \phi([-,-])} & \Omega^1_{\text{Ham}}(X)
\end{array}$$

Indeed, the bottom right triangle commutes manifestly, by equation (4.2). For the top left triangle notice that $[-,-]'$ vanishes here, by definition, and $[-,-]$ is given by

$$[(v, \alpha), f] = -\mathcal{L}_v f.$$

On the other hand, since the Hamiltonian vector field of $d_{\text{dR}}f$ vanishes, we also have

$$\begin{aligned}
\Phi((v, \alpha), (0, d_{\text{dR}}f)) &= \iota_v d_{\text{dR}}f \\
&= \mathcal{L}_v f
\end{aligned}$$

It remains to check that Φ respects the Jacobiator, sending the trivial one on $\Omega^1(X)_{\text{Ham},p}$ to the nontrivial one of def. 4.4.163. From now on we leave the isomorphism $\phi : \Omega^1(X)_{\text{Ham},p} \xrightarrow{\cong} \Omega^1(X)_{\text{Ham}}$ implicit, regarding $[-,-]'$ and $[-,-]$ as two different brackets on the same vector space.

Observe that generally, with a chain homotopy of binary brackets Φ given as above, setting

$$J(h_1, h_2, h_3) := \Phi(h_1, [h_2, h_3]) + \text{cyc}$$

for all h_1, h_2, h_3 makes the collection of brackets $([-,-]', J)$ (extended by 0 to $C^\infty(X)$) a Lie 2-algebra structure on $C^\infty(X) \rightarrow \Omega^1(X)_{\text{Ham}}$ such that (ϕ, Φ) a Lie 2-algebra equivalence. Notice that we may equivalently write

$$J(h_1, h_2, h_3) = -\Phi(D(h_1 \vee h_2 \vee h_3)),$$

where $(\vee^\bullet \Omega^1(X)_{\text{Ham}}, D)$ is the differential coalgebra incarnation of the Lie algebra $[-,-]$.

Indeed, J vanishes on the image of d_{dR} , because

$$\begin{aligned}
\Phi(d_{\text{dR}}f, [h_2, h_3]) + \Phi(h_2, [h_3, d_{\text{dR}}f]) + \Phi(h_3, [d_{\text{dR}}f, h_2]) &= -d_{\text{dR}}([f, [h_2, h_3 + [h_2, [h_3, f + [h_3, [f, h_2]]]]) \\
&= 0
\end{aligned}$$

where we used the chain homotopy property of ϕ and the identities of the differential crossed module $[-,-]$.

Using this, the coherence law of the Jacobiator, which a priori involves $[-,-]'$, is equivalently formulated in terms of $[-,-]$ (because the two differ by something in the image of d_{dR}), where it then reads

$$J(D(h_1 \vee h_2 \vee h_3 \vee h_4)) = 0,$$

with $(\vee^\bullet \Omega^1(X)_{\text{Ham}}, D)$ as before. This equation follows now due to $D^2 = 0$.

Finally, to see that J as above indeed is a Jacobiator for $[-,-]'$ we compute

$$\begin{aligned}
[h_1, [h_2, h_3]]' + \text{cyc} &= [h_1, [h_2, h_3 + d_{\text{dR}}\Phi(h_2, h_3)]]' + \text{cyc} \\
&= [h_1, [h_2, h_3 + [h_1, d_{\text{dR}}\Phi(h_2, h_3)]] + d_{\text{dR}}\Phi(h_1, [h_2, h_3] + d_{\text{dR}}\Phi(h_2, h_3)) + \text{cyc}, \\
&= d_{\text{dR}}\Phi(h_1, [h_2, h_3]) + \text{cyc}
\end{aligned}$$

where in the last step the first summand disappears due to the Jacobi identity satisfied by $[-,-]$, and where we used the chain homotopy property of Φ to cancel two terms.

This way we have produced an equivalence of Lie 2-algebras

$$(\phi, \Phi) : \mathbf{poisson}(X, \hat{\omega}) \rightarrow ((C^\infty(X) \rightarrow \Omega^1(X)_{\text{Ham}}), [-,-]', J),$$

where on the right the binary bracket is that of def. 4.4.163. The last thing to check is that the Jacobiator J is indeed that of def. 4.4.163. But since the differential in the Lie 2-algebra is d_{dR} , any two Jacobiators for the same binary bracket must differ by a constant function on X . Since at the same time the Jacobiators are linear, that constant must be 0, and hence the two Jacobiators must coincide. \square

4.5 Synthetic differential ∞ -groupoids

We discuss ∞ -groupoids equipped with *synthetic differential cohesion*, a version of smooth cohesion in which an explicit notion of smooth *infinitesimal* spaces exists.

Notice that the category $\text{CartSp}_{\text{smooth}}$, def. 4.4.4, is (the syntactic category of) a finitary algebraic theory: a *Lawvere theory* (see chapter 3, volume 2 of [Borc94]).

Definition 4.5.1. Write

$$\text{SmoothAlg} := \text{Alg}(\text{CartSp}_{\text{smooth}})$$

for the category of algebras over the algebraic theory $\text{CartSp}_{\text{smooth}}$: the category of product-preserving functors $\text{CartSp}_{\text{smooth}} \rightarrow \text{Set}$.

These algebras are traditionally known as C^∞ -rings or C^∞ -algebras [KaKrMi87].

Proposition 4.5.2. *The map that sends a smooth manifold X to the product-preserving functor*

$$C^\infty(X) : \mathbb{R}^k \mapsto \text{SmoothMfd}(X, \mathbb{R}^k)$$

extends to a full and faithful embedding

$$\text{SmoothMfd} \hookrightarrow \text{SmoothAlg}^{\text{op}}.$$

Proposition 4.5.3. *Let A be an ordinary (associative) \mathbb{R} -algebra that as an \mathbb{R} -vector space splits as $\mathbb{R} \oplus V$ with V finite dimensional as an \mathbb{R} -vector space and nilpotent with respect to the algebra structure: ($v \in V \hookrightarrow A$) $\Rightarrow (v^2 = 0)$.*

There is a unique lift of A through the forgetful functor $\text{SmoothAlg} \rightarrow \text{Alg}_{\mathbb{R}}$.

Proof. Use Hadamard's lemma. □

Remark 4.5.4. In the context of synthetic differential geometry the algebras of prop. 4.5.3 are usually called *Weil algebras*. In other contexts however the underlying rings are known as *Artin rings*, see for instance [L-Lie].

Definition 4.5.5. Write

$$\text{InfSmoothLoc} \hookrightarrow \text{SmoothAlg}^{\text{op}}$$

for the full subcategory of the opposite of smooth algebras on those of the form of prop. 4.5.3. We call this the category of *infinitesimal smooth loci* or of *infinitesimally thickened points*.

Write

$$\text{CartSp}_{\text{synthdiff}} := \text{CartSp}_{\text{smooth}} \times \text{InfSmoothLoc} \hookrightarrow \text{SmoothAlg}^{\text{op}}$$

for the full subcategory of the opposite of smooth algebras on those that are products

$$X \simeq U \times D$$

in $\text{SmoothAlg}^{\text{op}}$ of an object U in the image of $\text{CartSp}_{\text{smooth}} \hookrightarrow \text{SmoothMfd} \hookrightarrow \text{SmoothAlg}^{\text{op}}$ and an object D in the image of $\text{InfSmoothLoc} \hookrightarrow \text{SmoothAlg}^{\text{op}}$.

Define a coverage on $\text{CartSp}_{\text{synthdiff}}$ whose covering families are precisely those of the form $\{U_i \times D \xrightarrow{(f_i, \text{id})} U \times D\}$ for $\{U_i \xrightarrow{f_i} U\}$ a covering family in $\text{CartSp}_{\text{smooth}}$.

Remark 4.5.6. This definition appears in [Kock86], following [Dub79b]. The sheaf topos $\text{Sh}(\text{CartSp}_{\text{synthdiff}}) \hookrightarrow \text{SynthDiff}\infty\text{Grpd}$ over this site is equivalent to the *Cahiers topos* [Dub79b] which is a model of some set of axioms of *synthetic differential geometry* (see [Law97] for the abstract idea, where also the relation to the axiomatics of cohesion is vaguely indicated). Therefore the following definition may be thought of as describing the ∞ -*Cahiers topos* providing a higher geometry version of this model of synthetic differential smooth geometry.

Definition 4.5.7. The ∞ -topos of *synthetic differential smooth ∞ -groupoids* is

$$\text{SynthDiff}\infty\text{Grpd} := \text{Sh}_{(\infty,1)}(\text{CartSp}_{\text{synthdiff}}).$$

Proposition 4.5.8. $\text{SynthDiff}\infty\text{Grpd}$ is a *cohesive ∞ -topos*.

Proof. Using that the covering families of $\text{CartSp}_{\text{synthdiff}}$ do by definition not depend on the infinitesimal smooth loci D and that these each have a single point, one finds that $\text{CartSp}_{\text{synthdiff}}$ is an ∞ -cohesive site, def. 3.4.17, by reducing to the argument as for $\text{CartSp}_{\text{top}}$, prop. 4.3.2. The claim then follows with prop. 3.4.18. \square

Definition 4.5.9. Write FSmoothMfd for the category of *formal smooth manifolds* – manifolds modeled on $\text{CartSp}_{\text{synthdiff}}$, equipped with the induced site structure.

Proposition 4.5.10. We have an equivalence of ∞ -categories

$$\text{SynthDiff}\infty\text{Grpd} \simeq \hat{\text{Sh}}_{(\infty,1)}(\text{FSmoothMfd})$$

with the hypercomplete ∞ -topos over formal smooth manifolds.

Proof. By definition $\text{CartSp}_{\text{synthdiff}}$ is a dense sub-site of FSmoothMfd . The statement then follows as in prop. 4.3.7. \square

Write $i : \text{CartSp}_{\text{smooth}} \hookrightarrow \text{CartSp}_{\text{synthdiff}}$ for the canonical embedding.

Proposition 4.5.11. The functor i^* given by restriction along i exhibits $\text{SynthDiff}\infty\text{Grpd}$ as an infinitesimal cohesive neighbourhood, def. 3.5.1, of $\text{Smooth}\infty\text{Grpd}$, in that we have a quadruple of adjoint ∞ -functors

$$(i_! \dashv i^* \dashv i_* \dashv i^!) : \text{Smooth}\infty\text{Grpd} \rightarrow \text{SynthDiff}\infty\text{Grpd},$$

such that $i_!$ is full and faithful and preserves the terminal object.

Proof. We observe that $\text{CartSp}_{\text{smooth}} \hookrightarrow \text{CartSp}_{\text{synthdiff}}$ is an infinitesimal neighbourhood of sites, according to def. 3.5.6. The claim then follows with prop. 3.5.7. \square

We now discuss the general abstract structures in cohesive ∞ -toposes, 3.9 and 3.5, realized in $\text{SynthDiff}\infty\text{Grpd}$

- 4.5.1 – ∞ -Lie algebroids;
- 4.5.2 – Manifolds
- 4.5.3 – Cohomology;
- 4.5.5 – Paths and geometric Postnikov towers;
- 4.5.6 – Formally smooth/étale/unramified morphisms;
- 4.5.7 – Formally étale groupoids;
- 4.5.8 – Chern-Weil theory.

4.5.1 ∞ -Lie algebroids

We discuss explicit presentations for first order formal cohesive ∞ -groupoids, 3.10.9, realized in $\text{SynthDiff}\infty\text{Grpd}$. We call these L_∞ -algebroids, subsuming the traditional notion of L_∞ -algebras [LaMa95].

In the standard presentation of $\text{SynthDiff}\infty\text{Grpd}$ by simplicial presheaves over formal smooth manifolds these L_∞ -algebroids are presheaves in the image of the *monoidal Dold-Kan correspondence* [CaCo04] of semi-free differential graded algebras. This construction amounts to identifying the traditional description of Lie algebras, Lie algebroids and L_∞ -algebras by their Chevalley-Eilenberg algebras, def. 1.2.143, as a convenient characterization of the corresponding cosimplicial algebras whose formal dual simplicial presheaves are manifest presentations of infinitesimal smooth ∞ -groupoids.

- 4.5.1.1 – L_∞ -Algebroids and smooth commutative dg-algebras;
- 4.5.1.2 – Infinitesimal smooth ∞ -groupoids;
- 4.5.1.3 – Lie 1-algebroids as infinitesimal simplicial presheaves

4.5.1.1 L_∞ -Algebroids and smooth commutative dg-algebras Recall the characterization of L_∞ -algebra structures in terms of dg-algebras from prop. 1.2.145.

Definition 4.5.12. Let

$$\text{CE} : L_\infty\text{Alg} \leftrightarrow \text{cdgAlg}_{\mathbb{R}}^{\text{op}}$$

be the full subcategory on the opposite category of cochain dg-algebras over \mathbb{R} on those dg-algebras that are

- graded-commutative;
- concentrated in non-negative degree (the differential being of degree +1);
- in degree 0 of the form $C^\infty(X)$ for $X \in \text{SmoothMfd}$;
- semifree: their underlying graded algebra is isomorphic to an exterior algebra on an \mathbb{N} -graded locally free projective $C^\infty(X)$ -module;
- of finite type;

We call this the category of L_∞ -algebroids over smooth manifolds.

More in detail, an object $\mathfrak{a} \in L_\infty\text{Alg}$ may be identified (non-canonically) with a pair $(\text{CE}(\mathfrak{a}), X)$, where

- $X \in \text{SmoothMfd}$ is a smooth manifold – called the *base space* of the L_∞ -algebroid;
- \mathfrak{a} is the module of smooth sections of an \mathbb{N} -graded vector bundle of degreewise finite rank;

- $\text{CE}(\mathfrak{a}) = (\wedge_{C^\infty(X)}^\bullet \mathfrak{a}^*, d_{\mathfrak{a}})$ is a semifree dg-algebra on \mathfrak{a}^* – a Chevalley-Eilenberg algebra – where

$$\wedge_{C^\infty(X)}^\bullet \mathfrak{a}^* = C^\infty(X) \oplus \mathfrak{a}_0^* \oplus ((\mathfrak{a}_0^* \wedge_{C^\infty(X)} \mathfrak{a}_0^*) \oplus \mathfrak{a}_1^*) \oplus \cdots$$

with the k th summand on the right being in degree k .

Definition 4.5.13. An L_∞ -algebroid with base space $X = *$ the point is an L_∞ -algebra \mathfrak{g} , def. 1.2.143, or rather is the pointed delooping of an L_∞ -algebra. We write bg for L_∞ -algebroids over the point. They form the full subcategory

$$L_\infty\text{Alg} \hookrightarrow L_\infty\text{Algd}.$$

The following fact is standard and straightforward to check.

- Proposition 4.5.14.**
1. The full subcategory $L_\infty\text{Alg} \hookrightarrow L_\infty\text{Algd}$ from def. 4.5.12 is equivalent to the traditional definition of the category of L_∞ -algebras and “weak morphisms” / “sh-maps” between them.
 2. The full subcategory $\text{LieAlgd} \hookrightarrow L_\infty\text{Algd}$ on the 1-truncated objects is equivalent to the traditional category of Lie algebroids (over smooth manifolds).
 3. In particular the joint intersection $\text{LieAlg} \hookrightarrow L_\infty\text{Alg}$ on the 1-truncated L_∞ -algebras is equivalent to the category of ordinary Lie algebras.

We now construct an embedding of $L_\infty\text{Algd}$ into $\text{SynthDiff}_\infty\text{Grpd}$. Below in 4.5.1.2 we show that this embedding exhibits the above algebraic data as a presentation of synthetic differential ∞ -groupoids which are infinitesimal objects in the abstract intrinsic sense of 4.5.1.2.

Remark 4.5.15. The functor

$$\Xi : \text{Ch}_+^\bullet(\mathbb{R}) \rightarrow \text{Vect}_{\mathbb{R}}^\Delta$$

of the Dold-Kan correspondence, prop. 2.2.31, from non-negatively graded cochain complexes of vector spaces to cosimplicial vector spaces is a lax monoidal functor and hence induces a functor (which we will denote by the same symbol)

$$\Xi : \text{dgAlg}_{\mathbb{R}}^+ \rightarrow \text{Alg}_{\mathbb{R}}^\Delta$$

from non-negatively graded commutative cochain dg-algebras to cosimplicial commutative algebras (over \mathbb{R}).

Definition 4.5.16. Write

$$\Xi\text{CE} : L_\infty\text{Algd} \rightarrow (\text{CAlg}_{\mathbb{R}}^\Delta)^{\text{op}}$$

for the restriction of the functor Ξ from remark 4.5.15 along the defining inclusion $\text{CE} : L_\infty\text{Algd} \hookrightarrow \text{dgAlg}_{\mathbb{R}}^{\text{op}}$.

There are several different ways to present ΞCE explicitly in components. Below we make use of the following fact, pointed out in [CaCo04] (see the discussion around equations (26) and (49) there).

Proposition 4.5.17. The functor ΞCE from def. 4.5.16 is given as follows.

For $\mathfrak{a} \in L_\infty\text{Algd}$, the underlying cosimplicial vector space of $\Xi\text{CE}(\mathfrak{a})$ is

$$\Xi\text{CE}(\mathfrak{a}) : [n] \mapsto \bigoplus_{i=0}^n \text{CE}(\mathfrak{a})_i \otimes \wedge^i \mathbb{R}^n.$$

The product of the \mathbb{R} -algebra structure on this space in degree n is given on homogeneous elements $(\omega, x), (\lambda, y) \in \text{CE}(\mathfrak{a})_i \otimes \wedge^i \mathbb{R}^n$ in the tensor product by

$$(\omega, x) \cdot (\lambda, y) = (\omega \wedge \lambda, x \wedge y).$$

(Notice that $\Xi\mathfrak{a}$ is indeed a commutative cosimplicial algebra, since ω and x in (ω, x) are by definition in the same degree.)

To define the cosimplicial structure, let $\{v_j\}_{j=1}^n$ be the canonical basis of \mathbb{R}^n and consider and set $v_0 := 0$ to obtain a set of vectors $\{v_j\}_{j=0}^n$. Then for $\alpha : [k] \rightarrow [l]$ a morphism in the simplex category, set

$$\alpha : v_j \mapsto v_{\alpha(j)} - v_{\alpha(0)}$$

and extend this skew-multilinearly to a map $\alpha : \wedge^\bullet \mathbb{R}^k \rightarrow \wedge^\bullet \mathbb{R}^l$. In terms of all this the action of α on homogeneous elements (ω, x) in the cosimplicial algebra is defined by

$$\alpha : (\omega, x) \mapsto (\omega, \alpha x) + (d_{\mathbf{a}}\omega, v_{\alpha(0)} \wedge \alpha(x))$$

Remark 4.5.18. The commutative algebras appearing here may be understood geometrically as being algebras of functions on spaces of infinitesimal based simplices. This we discuss in more detail in 4.5.1.3 below, see prop. 4.5.29 there.

We now refine the image of Ξ to cosimplicial *smooth* algebras, def. 4.5.1. Notice that there is a canonical forgetful functor

$$U : \text{SmoothAlg} \rightarrow \text{CAlg}_{\mathbb{R}}$$

from the category of smooth algebras to the category of commutative associative algebras over the real numbers.

Proposition 4.5.19. *There is a unique factorization of the functor $\Xi \text{CE} : L_{\infty} \text{Algd} \rightarrow (\text{CAlg}_{\mathbb{R}}^{\Delta})^{\text{op}}$ from def. 4.5.16 through the forgetful functor $(\text{SmoothAlg}_{\mathbb{R}}^{\Delta})^{\text{op}} \rightarrow (\text{CAlg}_{\mathbb{R}}^{\Delta})^{\text{op}}$ such that for any \mathbf{a} over base space X the degree-0 algebra of smooth functions $C^{\infty}(X)$ lifts to its canonical structure as a smooth algebra*

$$\begin{array}{ccc} & (\text{SmoothAlg}_{\mathbb{R}}^{\Delta})^{\text{op}} & \\ \nearrow \Xi \text{CE} & \downarrow U & \\ L_{\infty} \text{Algd} & \longrightarrow & (\text{CAlg}_{\mathbb{R}}^{\Delta})^{\text{op}} \end{array}$$

Proof. Observe that for each n the algebra $(\Xi \text{CE}(\mathbf{a}))_n$ is a finite nilpotent extension of $C^{\infty}(X)$. The claim then follows with the fact that $C^{\infty} : \text{SmoothMfd} \rightarrow \text{CAlg}_{\mathbb{R}}^{\text{op}}$ is faithful and using Hadamard's lemma for the nilpotent part. \square

Proposition 4.5.20. *The functor ΞCE preserves limits of L_{∞} -algebras. It preserves pullbacks of L_{∞} -algebroids if the two morphisms in degree 0 are transversal maps of smooth manifolds.*

Proof. The functor $\Xi : \text{cdgAlg}_{\mathbb{R}}^+ \rightarrow \text{CAlg}_{\mathbb{R}}^{\Delta}$ evidently preserves colimits. This gives the first statement. The second follows by observing that the functor from smooth manifolds to the opposite of smooth algebras preserves transversal pullbacks. \square

4.5.1.2 Infinitesimal smooth groupoids We discuss how the L_{∞} -algebroids from def. 4.5.12 serve to present the intrinsically defined infinitesimal smooth ∞ -groupoids from 3.10.9.

Definition 4.5.21. Write $i : L_{\infty} \text{Algd} \rightarrow \text{SynthDiff}\infty \text{Grpd}$ for the composite ∞ -functor

$$L_{\infty} \text{Algd} \xrightarrow{\Xi \text{CE}} (\text{SmoothAlg}_{\mathbb{R}}^{\Delta})^{\text{op}} \xrightarrow{j} [\text{CartSp}_{\text{synthdiff}}^{\text{op}}, \text{sSet}] \xrightarrow{PQ} ([\text{CartSp}_{\text{synthdiff}}^{\text{op}}, \text{sSet}]_{\text{loc}})^{\circ} \xrightarrow{\simeq} \text{SynthDiff}\infty \text{Grpd} ,$$

where the first morphism is the monoidal Dold-Kan correspondence as in prop. 4.5.19, the second is degree-wise the external Yoneda embedding

$$\text{SmoothAlg}^{\text{op}} \rightarrow [\text{CartSp}_{\text{synthdiff}}, \text{Set}] ,$$

and PQ is any fibrant-cofibrant resolution functor in the local model structure on simplicial presheaves.

We discuss now that $L_\infty\text{Alg}$ is indeed a presentation for objects in $\text{SynthDiff}\infty\text{Grpd}$ satisfying the abstract axioms from 3.10.9.

Lemma 4.5.22. *For $\mathbf{a} \in L_\infty\text{Alg}$ and $i(\mathbf{a}) \in [\text{FSmoothMfd}^{\text{op}}, \text{sSet}]_{\text{proj,loc}}$ its image in the presentation for $\text{SynthDiff}\infty\text{Grpd}$, we have that*

$$\left(\int^{[k] \in \Delta} \Delta[k] \cdot i(\mathbf{a})_k \right) \xrightarrow{\cong} i(\mathbf{a})$$

is a cofibrant resolution, where $\Delta : \Delta \rightarrow \text{sSet}$ is the fat simplex.

Proof. The coend over the tensoring

$$\int^{[k] \in \Delta} (-) \cdot (-) : [\Delta, \text{sSet}_{\text{Quillen}}]_{\text{proj}} \times [\Delta^{\text{op}}, [\text{FSmoothMfd}^{\text{op}}, \text{sSet}]_{\text{proj,loc}}]_{\text{inj}} \rightarrow [\text{FSmoothMfd}^{\text{op}}, \text{sSet}]_{\text{proj,loc}}$$

for the projective and injective global model structure on functors on the simplex category and its opposite is a left Quillen bifunctor, prop. 2.3.17. We have moreover

1. The fat simplex is cofibrant in $[\Delta, \text{sSet}_{\text{Quillen}}]_{\text{proj}}$, prop. 2.3.19.
2. The object $i(\mathbf{a})_\bullet \in [\Delta^{\text{op}}, [\text{FSmoothMfd}^{\text{op}}, \text{sSet}]_{\text{proj,loc}}]_{\text{inj}}$ is cofibrant, because every representable $\text{FSmoothMfd} \hookrightarrow [\text{FSmoothMfd}^{\text{op}}, \text{sSet}]_{\text{proj,loc}}$ is cofibrant.

□

Proposition 4.5.23. *Let \mathfrak{g} be an L_∞ -algebra, regarded as an L_∞ -algebroid $b\mathfrak{g} \in L_\infty\text{Alg}$ over the point by the embedding of def. 4.5.12. Then $i(b\mathfrak{g}) \in \text{SynthDiff}\infty\text{Grpd}$ is an infinitesimal object, def. 3.10.49, in that it is geometrically contractible*

$$\Pi b\mathfrak{g} \simeq *$$

and has as underlying discrete ∞ -groupoid the point

$$\Gamma b\mathfrak{g} \simeq *.$$

Proof. We present now $\text{SynthDiff}\infty\text{Grpd}$ by $[\text{CartSp}_{\text{synthdiff}}^{\text{op}}, \text{sSet}]_{\text{proj,loc}}$. Since $\text{CartSp}_{\text{synthdiff}}$ is an ∞ -cohesive site by prop. 4.5.8, we have by the proof of prop. 3.4.18 that Π is presented by the left derived functor $\mathbb{L}\lim \rightarrow$ of the degreewise colimit and Γ is presented by the left derived functor of evaluation on the point.

With lemma 4.5.22 we can evaluate

$$\begin{aligned} (\mathbb{L}\lim_{\rightarrow} i(b\mathfrak{g})) &\simeq \lim_{\rightarrow} \int^{[k] \in \Delta} \Delta[k] \cdot (b\mathfrak{g})_k \\ &\simeq \int^{[k] \in \Delta} \Delta[k] \cdot \lim_{\rightarrow} (b\mathfrak{g})_k, \\ &= \int^{[k] \in \Delta} \Delta[k] \cdot * \end{aligned}$$

because each $(b\mathfrak{g})_n \in \text{InfPoint} \hookrightarrow \text{CartSp}_{\text{smooth}}$ is an infinitesimally thickened point, hence representable and hence sent to the point by the colimit functor.

That this is equivalent to the point follows from the fact that $\emptyset \rightarrow \Delta$ is an acyclic cofibration in $[\Delta, \text{sSet}_{\text{Quillen}}]_{\text{proj}}$, and that

$$\int^{[k] \in \Delta} (-) \times (-) : [\Delta, \text{sSet}_{\text{Quillen}}]_{\text{proj}} \times [\Delta^{\text{op}}, \text{sSet}_{\text{Quillen}}]_{\text{inj}} \rightarrow \text{sSet}_{\text{Quillen}}$$

is a Quillen bifunctor, using that $*$ in $[\Delta^{\text{op}}, \text{sSet}_{\text{Quillen}}]_{\text{inj}}$ is cofibrant.

Similarly, we have degreewise that

$$\text{Hom}(*, (b\mathfrak{g})_n) = *$$

by the fact that an infinitesimally thickened point has a single global point. Therefore the claim for Γ follows analogously. \square

Proposition 4.5.24. *Let $\mathfrak{a} \in L_\infty\text{Algd} \hookrightarrow [\text{CartSp}_{\text{synthdiff}}, \text{sSet}]$ be an L_∞ -algebroid, def. 4.5.12, over a smooth manifold X , regarded as a simplicial presheaf and hence as a presentation for an object in $\text{SynthDiff}_\infty\text{Grpd}$ according to def. 4.5.21.*

We have an equivalence

$$\mathbf{\Pi}_{\text{inf}}(\mathfrak{a}) \simeq \mathbf{\Pi}_{\text{inf}}(X).$$

Proof. Let first $X = U \in \text{CartSp}_{\text{synthdiff}}$ be a representable. Then according to prop. 4.5.22 we have that

$$\hat{\mathfrak{a}} := \left(\int^{k \in \Delta} \Delta[k] \cdot \mathfrak{a}_k \right) \simeq \mathfrak{a}$$

is cofibrant in $[\text{CartSp}_{\text{synthdiff}}^{\text{op}}, \text{sSet}]_{\text{proj}}$. Therefore, by prop. 3.5.7, we compute the derived functor

$$\begin{aligned} \mathbf{\Pi}_{\text{inf}}(\mathfrak{a}) &\simeq i_* i^* \mathfrak{a} \\ &\simeq \mathbb{L}((-) \circ p) \mathbb{L}((-) \circ i) \mathfrak{a} \\ &\simeq ((-) \circ ip) \hat{\mathfrak{a}} \end{aligned}$$

with the notation as used there. In view of def. 4.5.16 we have for all $k \in \mathbb{N}$ that $\mathfrak{a}_k = X \times D$ where D is an infinitesimally thickened point. Therefore $((-) \circ ip) \mathfrak{a}_k = ((-) \circ ip) X$ for all k and hence $((-) \circ ip) \hat{\mathfrak{a}} \simeq \mathbf{\Pi}_{\text{inf}}(X)$.

For general X choose first a cofibrant resolution by a split hypercover that is degreewise a coproduct of representables (which always exists, by the cofibrant replacement theorem of [Dug01]), then pull back the above discussion to these covers. \square

Corollary 4.5.25. *Every L_∞ -algebroid in the sense of def. 4.5.12 under the embedding of def. 4.5.21 is indeed a formal cohesive ∞ -groupoid in the sense of def. 3.10.49.*

4.5.1.3 Lie 1-algebroids as infinitesimal simplicial presheaves We characterize Lie 1-algebroids $(E \rightarrow X, \rho, [-, -])$ as precisely those synthetic differential ∞ -groupoids that under the presentation of def. 4.5.21 are locally, on any chart $U \rightarrow X$ of their base space, given by simplicial smooth loci of the form

$$\cdots \cdots \cdots U \times \tilde{D}(k, 2) \begin{array}{c} \rightrightarrows \\ \rightrightarrows \\ \rightrightarrows \end{array} U \times \tilde{D}(k, 1) \rightrightarrows U$$

where $k = \text{rank}(E)$ is the dimension of the fibers of the Lie algebroid and where $\tilde{D}(k, n)$ is the smooth locus of *infinitesimal k -simplices* based at the origin in \mathbb{R}^n . (These smooth loci have been highlighted in section 1.2 of [Kock10]).

The following definition may be either taken as an informal but instructive definition – in which case the next definition 4.5.27 is to be taken as the precise one – or in fact it may be already itself be taken as the fully formal and precise definition if one reads it in the internal logic of any smooth topos with line object R – which for the present purpose is the *Cahiers topos* [Dub79b] $\text{Sh}(\text{CartSp}_{\text{synthdiff}})$ with line object R , remark 4.5.6.

Definition 4.5.26. For $k, n \in \mathbb{N}$, an *infinitesimal k -simplex* in R^n based at the origin is a collection $(\vec{\epsilon}_a \in R^n)_{a=1}^k$ of points in R^n , such that each is an infinitesimal neighbour of the origin

$$\forall a : \vec{\epsilon}_a \sim 0$$

and such that all are infinitesimal neighbours of each other

$$\forall a, a' : (\vec{\epsilon}_a - \vec{\epsilon}_{a'}) \sim 0.$$

Write $\tilde{D}(k, n) \subset R^{k \cdot n}$ for the space of all such infinitesimal k -simplices in R^n .

Equivalently:

Definition 4.5.27. For $k, n \in \mathbb{N}$, the smooth algebra

$$C^\infty(\tilde{D}(k, n)) \in \text{SmoothAlg}$$

is the unique lift through the forgetful functor $U : \text{SmoothAlg} \rightarrow \text{CAlg}_{\mathbb{R}}$ of the commutative \mathbb{R} -algebra generated from $k \times n$ many generators

$$(\epsilon_a^j)_{1 \leq j \leq n, 1 \leq a \leq k}$$

subject to the relations

$$\forall a, j, j' : \epsilon_a^j \epsilon_a^{j'} = 0$$

and

$$\forall a, a', j, j' : (\epsilon_a^j - \epsilon_{a'}^j)(\epsilon_a^{j'} - \epsilon_{a'}^{j'}) = 0.$$

Remark 4.5.28. In the above form these relations are the manifest analogs of the conditions $\vec{\epsilon}_a \sim 0$ and $(\vec{\epsilon}_a - \vec{\epsilon}_{a'}) \sim 0$. But by multiplying out the latter set of relations and using the former, we find that jointly they are equivalent to the single set of relations

$$\forall a, a', j, j' : \epsilon_a^j \epsilon_{a'}^{j'} + \epsilon_{a'}^j \epsilon_a^{j'} = 0,$$

which of course is equivalent to

$$\forall a, a', j, j' : \epsilon_a^j \epsilon_{a'}^{j'} + \epsilon_{a'}^j \epsilon_a^{j'} = 0.$$

In this expression the roles of the two sets of indices is manifestly symmetric. Hence another equivalent way to state the relations is to say that

$$\forall a, a', j : \epsilon_a^j \epsilon_{a'}^j = 0$$

and

$$\forall a, a', j, j' : (\epsilon_a^j - \epsilon_{a'}^j)(\epsilon_{a'}^{j'} - \epsilon_a^{j'}) = 0$$

This appears around (1.2.1) in [Kock10].

The following proposition identifies these algebras of functions on spaces of infinitesimal based simplices with the algebras that appear in the component expression of the monoidal Dold-Kan correspondence, as displayed in prop. 4.5.17.

Proposition 4.5.29. For all $k, n \in \mathbb{N}$ we have a natural isomorphism of real commutative and hence of smooth algebras

$$\phi : C^\infty(\tilde{D}(k, n)) \xrightarrow{\cong} \bigoplus_{i=0}^n (\wedge^i \mathbb{R}^k) \otimes (\wedge^i \mathbb{R}^n),$$

where on the right we have the algebras that appear degreewise in def. 4.5.16, where the product is given on homogeneous elements by

$$(\omega, x) \cdot (\lambda, y) = (\omega \wedge \lambda, x \wedge y).$$

Proof. Let $\{t_a\}$ be the canonical basis for \mathbb{R}^k and $\{e^i\}$ the canonical basis for \mathbb{R}^n . We claim that an isomorphism is given by the assignment which on generators is

$$\phi : \epsilon_a^i \mapsto (t_a, e^i).$$

To see that this defines indeed an algebra homomorphism we need to check that it respects the relations on the generators. By remark 4.5.28 for this it is sufficient to observe that for all pairs of pairs of indices we have

$$\begin{aligned} \phi(\epsilon_a^i \epsilon_{a'}^{i'}) &= (t_a \wedge t_{a'}, e^i \wedge e^{i'}) \\ &= -(t_{a'} \wedge t_a, e^i \wedge e^{i'}) \\ &= -\phi(\epsilon_{a'}^{i'} \epsilon_a^i) \end{aligned}$$

□

Remark 4.5.30. The proof of prop. 4.5.29 together with remark 4.5.28 may be interpreted as showing how the skew-linearity which is the hallmark of traditional Lie theory arises in the synthetic differential geometry of infinitesimal simplices. In the context of the tangent Lie algebroid, discussed as example 4.5.33 below, this pleasant aspect of Kock’s “combinatorial differential forms” had been amplified in [BM00]. See also [Stel10].

Proposition 4.5.31. For $\mathfrak{a} \in L_\infty\text{Alg}$ a 1-truncated object, hence an ordinary Lie algebroid of rank k over a base manifold X , its image under the map $i : L_\infty\text{Alg} \rightarrow (\text{SmoothAlg}^\Delta)^{\text{op}}$, def. 4.5.21, is such that its restriction to any chart $U \rightarrow X$ is, up to isomorphism, of the form

$$i(\mathfrak{a})|_U : [n] \mapsto U \times \tilde{D}(k, n).$$

Proof. Apply prop. 4.5.29 in def. 4.5.16, using that by definition $\text{CE}(\mathfrak{a})$ is given by the exterior algebra on locally free $C^\infty(X)$ modules, so that

$$\begin{aligned} \text{CE}(\mathfrak{a}|_U) &\simeq (\wedge_{C^\infty(U)}^\bullet \Gamma(U \times \mathbb{R}^k)^*, d_{\mathfrak{a}|_U}) \\ &\simeq (C^\infty(U) \otimes \wedge^\bullet \mathbb{R}^k, d_{\mathfrak{a}|_U}) \end{aligned}$$

□

Example 4.5.32 (Lie algebra as infinitesimal simplicial complex). For G a Lie group, consider the simplicial manifold

$$\mathbf{BG}_{\text{ch}} = \left(\cdots \cdots G \times G \rightrightarrows G \rightrightarrows * \right) \in \text{SmthMfd}^{\Delta^{\text{op}}} \hookrightarrow [\text{CartSp}_{\text{synthdiff}}, \text{sSet}]$$

which presents the internal delooping \mathbf{BG} by prop. 4.3.21. Consider then the subobject (as simplicial formal manifolds)

$$\begin{array}{ccc} \begin{array}{c} \vdots \\ \tilde{D}(k, 2) \end{array} & \xrightarrow{i_2} & \begin{array}{c} \vdots \\ G \times G \end{array} \\ \Downarrow & & \Downarrow \\ \begin{array}{c} \tilde{D}(k, 1) \end{array} & \xrightarrow{i_1} & \begin{array}{c} G \end{array} \\ \Downarrow & & \Downarrow \\ * & \xrightarrow{i_0} & * \end{array} \quad ,$$

$$(\mathbf{Bg})_{\text{ch}} \hookrightarrow (\mathbf{BG})_{\text{ch}}$$

where $k = \dim(G)$, defined as follows:

1. i_1 includes the first order infinitesimal neighbourhood of the neutral element of G , hence synthetically $\{g \in G | g \sim_1 0\}$.
2. i_2 includes the space of pairs of points in G which are first order neighbours of the neutral element and of each other: $\{(g_1, g_2) \in G \times G | g_1 \sim_1 e, g_2 \sim_1 e, g_1 \sim g_2\}$.

This is implicitly the inclusion that is used in [Kock10] in the discussion of Lie algebras in synthetic differential geometry. By the above discussion the above identifies $\tilde{D}(k, 1) \simeq \mathfrak{g} = T_e(G)$ as the Lie algebra of G and $\tilde{D}(k, 2) \simeq \mathfrak{g} \wedge \mathfrak{g}$. Then formula 6.8.2 in [Kock10] together with theorem 6.6.1 there show how the group product on the right turns into the Lie bracket on the left.

More in detail, formula 6.8.2 in [Kock10] says that for $g_1, g_2 \sim_1 e$ and $g_1 \sim_1 g_2$ we have

$$g_1 \cdot g_2 = g_1 + g_2 + \frac{1}{2}\{g_1, g_2\} - \frac{3}{2}e,$$

where $\{g_1, g_2\} = g_1 g_2 g_1^{-1} g_2^{-1}$ is the group commutator. Theorem 6.6.1 in [Kock10] identifies this on the given elements infinitesimally close to e with the Lie bracket on these elements.

Example 4.5.33 (tangent Lie algebroid as infinitesimal simplicial complex). For X a smooth manifold and TX tangent Lie algebroid, its incarnation as a simplicial smooth locus via def. 4.5.21, prop. 4.5.31 is the simplicial complex of *infinitesimal simplices* $\{(x_0, \dots, x_n) \in X^n | \forall i, j : x_i \sim x_j\}$ in X . The normalized cosimplicial function algebra of this complex is called the algebra of *combinatorial differential forms* in [Kock10]. The corresponding normalized chain dg-algebra is observed there to be isomorphic to the de Rham complex of X , which here is a direct consequence of the monoidal Dold-Kan correspondence. This is made explicit in [Stel10].

Notice that accordingly for \mathfrak{g} any L_∞ -algebra, flat \mathfrak{g} -valued differential forms are equivalently morphisms of dg-algebras

$$\Omega^\bullet(X) \leftarrow \text{CE}(\mathfrak{g}) : A$$

as well as (“synthetically”) morphisms

$$TX \rightarrow \mathfrak{g}$$

of simplicial objects in the Cahiers topos $\text{Sh}(\text{CartSp}_{\text{synthdiff}})$.

4.5.1.4 ∞ -Lie differentiation We comment on how the operation of *Lie differentiation* is realized in synthetic differential cohesion, the process that sends a pointed connected synthetic differential homotopy type to its infinitesimal approximation by an higher Lie algebra, an L_∞ -algebra.

Definition 4.5.34. Write

$$\text{Inf}\infty\text{Grpd} := \text{PSh}_\infty(\text{InfSmoothLoc})$$

for the ∞ -category of ∞ -presheaves on the site of infinitesimal smooth loci of def. 4.5.5 (formal duals of Weil algebras/Artin algebras). Write

$$\text{Inf}\infty\text{Grpd}_1 \hookrightarrow \text{Inf}\infty\text{Grpd}$$

for the reflective localization at the effective epimorphisms in InfSmoothLoc .

Proposition 4.5.35. *We have an ∞ -pushout diagram of ∞ -toposes of the form*

$$\begin{array}{ccc} \text{Smooth}\infty\text{Grpd} & \xrightarrow{i_*} & \text{SynthDiff}\infty\text{Grpd} \\ \Gamma \downarrow & & \downarrow \\ \infty\text{Grpd} & \longrightarrow & \text{Inf}\infty\text{Grpd} \end{array} .$$

Proof. By prop. 6.3.2.3 of [L-Topos] ∞ -pushouts of ∞ -toposes are computed as ∞ -limits of ∞ -categories with respect to the corresponding inverse image functors. Hence we have to show that there is an ∞ -pullback diagram of ∞ -categories of the form

$$\begin{array}{ccc} \text{Smooth}\infty\text{Grpd} & \xleftarrow{i^*} & \text{SynthDiff}\infty\text{Grpd} \\ \text{Disc} \uparrow & & \uparrow \\ \infty\text{Grpd} & \xleftarrow{\quad} & \text{Inf}\infty\text{Grpd} \end{array} .$$

Since inverse images preserve ∞ -colimits in the ∞ -topos, we may compute this kernel on generators, hence on objects in the site, under the ∞ -Yoneda embedding. By prop. 3.4.18 and prop. 3.5.7 this reduces to the diagram

$$\begin{array}{ccc} \text{CartSp}_{\text{smooth}} & \xleftarrow{p} & \text{CartSp}_{\text{synthdiff}} \\ * \uparrow & & \uparrow \\ * & \xleftarrow{\quad} & \text{InfSmoothLoc} \end{array} .$$

This is an evident pullback of categories, exhibiting the infinitesimal smooth loci as the objects in the kernel of the map that forgets infinitesimal thickening. \square

Proposition 4.5.36. *Write*

$$L\infty\text{Alg} \hookrightarrow \text{Inf}\infty\text{Grpd}_1$$

for the full sub- ∞ -category on those objects which are sent by Γ to the point. This is the ∞ -category of $L\infty$ -algebras.

Proof. By the central result of [L-Lie]. \square
Therefore we say that

Definition 4.5.37. The composite ∞ -functor

$$\text{Lie} : \text{Grp}(\text{Smooth}\infty\text{Grpd}) \simeq \text{Smooth}\infty\text{Grpd}_{\geq 1}^{*/} \xrightarrow{i_1^{*/}} \text{Smooth}\infty\text{Grpd}_{\geq 1}^{*/} \xrightarrow{j^*} L\infty\text{Alg}$$

is ∞ -Lie differentiation.

4.5.2 Manifolds

We discuss the general abstract notion of *separated manifolds*, 3.10.6, realized in the model of synthetic differential cohesion.

Let $\mathbb{A}^1 := \mathbb{R}^1$ be the standard line object of $\text{Smooth}\infty\text{Grpd}$ exhibiting its cohesion, by prop. 4.3.33.

Proposition 4.5.38. *The full subcategory of $\text{Smooth}\infty\text{Grpd}$ on the separated \mathbb{R} -manifolds, def. 3.10.36 is equivalently that of smooth Hausdorff paracompact manifolds*

$$\text{SmthMfd} \hookrightarrow \text{Smooth}\infty\text{Grpd} .$$

4.5.3 Cohomology

We discuss aspects of the intrinsic cohomology, 3.6.9, in $\text{SynthDiff}\infty\text{Grpd}$.

- 4.5.3.1 – Cohomology localization;
- 4.5.3.2 – Lie group cohomology
- 4.5.3.3 – ∞ -Lie algebroid cohomology
- 4.5.4 – Infinitesimal principal ∞ -bundles / extensions of L_∞ -algebroids

4.5.3.1 Cohomology localization

Observation 4.5.39. The canonical line object of the Lawvere theory $\text{CartSp}_{\text{smooth}}$ (the free algebra on the singleton) is the real line

$$\mathbb{A}_{\text{CartSp}_{\text{smooth}}}^1 = \mathbb{R}.$$

We shall write \mathbb{R} also for the underlying additive group

$$\mathbb{G}_a = \mathbb{R}$$

regarded canonically as an abelian ∞ -group object in $\text{SynthDiff}\infty\text{Grpd}$. For $n \in \mathbb{N}$ write $\mathbf{B}^n \mathbb{R} \in \text{SynthDiff}\infty\text{Grpd}$ for its n -fold delooping. For $n \in \mathbb{N}$ and $X \in \text{SynthDiff}\infty\text{Grpd}$ write

$$H_{\text{shdiff}}^n(X, \mathbb{R}) := \pi_0 \text{SynthDiff}\infty\text{Grpd}(X, \mathbf{B}^n \mathbb{R})$$

for the cohomology group of X with coefficients in the canonical line object in degree n .

Definition 4.5.40. Write

$$\mathbf{L}_{\text{sdiff}} \hookrightarrow \text{SynthDiff}\infty\text{Grpd}$$

for the cohomology localization of $\text{SynthDiff}\infty\text{Grpd}$ at \mathbb{R} -cohomology: the full sub- ∞ -category on the W -local objects with respect to the class W of morphisms that induce isomorphisms in all \mathbb{R} -cohomology groups.

Proposition 4.5.41. Let $\text{Ab}_{\text{proj}}^\Delta$ be the model structure on cosimplicial abelian groups, whose fibrations are the degreewise surjections and whose weak equivalences the quasi-isomorphisms under the normalized cochain functor.

The transferred model structure along the forgetful functor

$$U : \text{SmoothAlg}^\Delta \rightarrow \text{Ab}^\Delta$$

exists and yields a cofibrantly generated simplicial model category structure on cosimplicial smooth algebras (cosimplicial C^∞ -rings).

See [Stel10] for an account.

Proposition 4.5.42. Let $j : (\text{SmoothAlg}^\Delta)^{\text{op}} \rightarrow [\text{CartSp}_{\text{synthdiff}}, \text{sSet}]$ be the prolonged external Yoneda embedding.

1. This constitutes the right adjoint of a simplicial Quillen adjunction

$$(\mathcal{O} \dashv j) : (\text{SmoothAlg}^\Delta)^{\text{op}} \xrightleftharpoons[j]{\mathcal{O}} [\text{CartSp}_{\text{synthdiff}}, \text{sSet}]_{\text{proj,loc}},$$

where the left adjoint $\mathcal{O}(-) = C^\infty(-, \mathbb{R})$ degreewise forms the algebra of functions obtained by homming presheaves into the line object \mathbb{R} .

2. Restricted to simplicial formal smooth manifolds of finite truncation along

$$\mathbf{F}\mathbf{SmoothMfd}_{\text{fintr}}^{\Delta^{\text{op}}} \hookrightarrow (\mathbf{SmoothAlg}^{\Delta})^{\text{op}}$$

the right derived functor of j is a full and faithful ∞ -functor that factors through the cohomology localization and thus identifies a full reflective sub- ∞ -category

$$(\mathbf{F}\mathbf{SmoothMfd}^{\Delta^{\text{op}}})_{\text{fintr}}^{\circ} \hookrightarrow \mathbf{L}_{\text{sdiff}} \hookrightarrow \mathbf{SynthDiff}\infty\mathbf{Grpd}.$$

3. The intrinsic \mathbb{R} -cohomology of any object $X \in \mathbf{SynthDiff}\infty\mathbf{Grpd}$ is computed by the ordinary cochain cohomology of the Moore cochain complex underlying the cosimplicial abelian group of the image of the left derived functor $(\mathbb{L}\mathcal{O})(X)$ under the Dold-Kan correspondence:

$$H_{\mathbf{SynthDiff}}^n(X, \mathbb{R}) \simeq H_{\text{cochain}}^n(N^{\bullet}(\mathbb{L}\mathcal{O})(X)).$$

Proof. By prop. 4.5.10 we may equivalently work over the site $\mathbf{F}\mathbf{SmoothMfd}$. The proof there is given in [Stel10], following [Toë06]. \square

4.5.3.2 Lie group cohomology

Proposition 4.5.43. *Let $G \in \mathbf{SmoothMfd} \hookrightarrow \mathbf{Smooth}\infty\mathbf{Grpd} \hookrightarrow \mathbf{SynthDiff}\infty\mathbf{Grpd}$ be a Lie group.*

Then the intrinsic group cohomology in $\mathbf{Smooth}\infty\mathbf{Grpd}$ and in $\mathbf{SynthDiff}\infty\mathbf{Grpd}$ of G with coefficients in

1. discrete abelian groups A ;
2. the additive Lie group $A = \mathbb{R}$

coincides with Segal's refined Lie group cohomology [Seg70], [Bry00].

$$H_{\mathbf{Smooth}}^n(\mathbf{B}G, A) \simeq H_{\mathbf{SynthDiff}}^n(\mathbf{B}G, A) \simeq H_{\text{Segal}}^n(G, A).$$

Proof. For discrete coefficients this is shown in theorem 4.4.36 for $H_{\mathbf{Smooth}}$, which by the full and faithful embedding then also holds in $\mathbf{SynthDiff}\infty\mathbf{Grpd}$.

Here we demonstrate the equivalence for $A = \mathbb{R}$ by obtaining a presentation for $H_{\mathbf{SynthDiff}}^n(\mathbf{B}G, \mathbb{R})$ that coincides explicitly with a formula for Segal's cohomology observed in [Bry00].

Let therefore $\mathbf{B}G_{\text{ch}} \in [\Delta^{\text{op}}, [\mathbf{CartSp}_{\text{synthdiff}}^{\text{op}}, \mathbf{Set}]$ be the standard presentation of $\mathbf{B}G \in \mathbf{SynthDiff}\infty\mathbf{Grpd}$ by the nerve of the Lie groupoid $(G \rightrightarrows *)$ as discussed in 4.4.2. We may write this as

$$\mathbf{B}G_{\text{ch}} = \int^{[k] \in \Delta} \Delta[k] \cdot G^{\times_k}.$$

By prop. 4.5.42 the intrinsic \mathbb{R} -cohomology of $\mathbf{B}G$ is computed by the cochain cohomology of the cochain complex of the underlying simplicial abelian group of the value $(\mathbb{L}\mathcal{O})\mathbf{B}G_{\text{ch}}$ of the left derived functor of \mathcal{O} .

In order to compute this we shall build and compare various resolutions, as in prop. 4.3.16, moving back and forth through the Quillen equivalences

$$[\Delta^{\text{op}}, D]_{\text{inj}} \begin{array}{c} \xleftarrow{\text{id}} \\ \xrightarrow{\text{id}} \end{array} [\Delta^{\text{op}}, D]_{\text{Reedy}} \begin{array}{c} \xleftarrow{\text{id}} \\ \xrightarrow{\text{id}} \end{array} [\Delta^{\text{op}}, D]_{\text{proj}}$$

between injective, projective and Reedy model structures on functors with values in a combinatorial model category D , with D either $\mathbf{sSet}_{\text{Quillen}}$ or with D itself the injective or projective model structure on simplicial presheaves over $\mathbf{CartSp}_{\text{synthdiff}}$.

To begin with, let $(Q\mathbf{B}G_{\text{ch}})_{\bullet} \xrightarrow{\cong} (G^{\times \bullet}) \in [\Delta^{\text{op}}, [\text{CartSp}^{\text{op}}, \text{sSet}]_{\text{proj}}]_{\text{Reedy}}$ be a Reedy-cofibrant resolution of the simplicial presheaf $\mathbf{B}G_{\text{ch}}$ with respect to the projective model structure. This is in particular degreewise a weak equivalence of simplicial presheaves, hence

$$\int^{[k] \in \Delta} \Delta[k] \cdot (Q\mathbf{B}G_{\text{ch}})_k \xrightarrow{\cong} \int^{[k] \in \Delta} \Delta[k] \cdot G^{\times k} = \mathbf{B}G_c$$

exists and is a weak equivalence in $[\text{CartSp}_{\text{synthdiff}}^{\text{op}}, \text{sSet}]_{\text{inj}}$, hence in $[\text{CartSp}_{\text{synthdiff}}^{\text{op}}, \text{sSet}]_{\text{proj}}$, hence in $[\text{CartSp}_{\text{synthdiff}}^{\text{op}}, \text{sSet}]_{\text{proj,loc}}$, because

1. $\Delta \in [\Delta, \text{sSet}_{\text{Quillen}}]_{\text{Reedy}}$ is cofibrant in the Reedy model structure;
2. every simplicial presheaf X is Reedy cofibrant when regarded as an object $X_{\bullet} \in [\Delta^{\text{op}}, [\text{CartSp}^{\text{op}}, \text{sSet}]_{\text{inj}}]_{\text{Reedy}}$;
3. the coend over the tensoring

$$\int^{\Delta} : [\Delta, \text{sSet}_{\text{Quillen}}]_{\text{Reedy}} \times [\Delta^{\text{op}}, [\text{CartSp}_{\text{synthdiff}}^{\text{op}}, \text{sSet}]_{\text{inj}}]_{\text{Reedy}} \rightarrow [\text{CartSp}_{\text{synthdiff}}^{\text{op}}, \text{sSet}]_{\text{inj}}$$

is a left Quillen bifunctor ([L-Topos], prop. A.2.9.26), hence in particular a left Quillen functor in one argument when the other argument is fixed on a cofibrant object, hence preserves weak equivalences between cofibrant objects in that case.

To make this a projective cofibrant resolution we further pull back along the Bousfield-Kan fat simplex projection $\mathbf{\Delta} \rightarrow \Delta$ with $\mathbf{\Delta} := N(\Delta/(-))$ to obtain

$$\int^{[k] \in \Delta} \mathbf{\Delta}[k] \cdot (Q\mathbf{B}G_{\text{ch}})_k \xrightarrow{\cong} \int^{[k] \in \Delta} \Delta[k] \cdot (Q\mathbf{B}G_{\text{ch}})_k \xrightarrow{\cong} \mathbf{B}G_{\text{ch}},$$

which is a weak equivalence again due to the left Quillen bifunctor property of $\int^{\Delta}(-) \cdot (-)$, now applied with the second argument fixed, and the fact that $\mathbf{\Delta} \rightarrow \Delta$ is a weak equivalence between cofibrant objects in $[\Delta, \text{sSet}]_{\text{Reedy}}$. (This is the *Bousfield-Kan map*). Finally, that this is indeed cofibrant in $[\text{CartSp}^{\text{op}}, \text{sSet}]_{\text{proj}}$ follows from

1. the fact that the Reedy cofibrant $(Q\mathbf{B}G_{\text{ch}})_{\bullet}$ is also cofibrant in $[\Delta^{\text{op}}, [\text{CartSp}^{\text{op}}, \text{sSet}]_{\text{proj}}]_{\text{inj}}$;
2. the left Quillen bifunctor property of

$$\int^{\Delta} : [\Delta, \text{sSet}_{\text{Quillen}}]_{\text{proj}} \times [\Delta^{\text{op}}, [\text{CartSp}_{\text{synthdiff}}^{\text{op}}, \text{sSet}]_{\text{proj}}]_{\text{inj}} \rightarrow [\text{CartSp}_{\text{synthdiff}}^{\text{op}}, \text{sSet}]_{\text{proj}};$$

3. the fact that the fat simplex is cofibrant in $[\Delta, \text{sSet}]_{\text{proj}}$.

The central point so far is that in order to obtain a projective cofibrant resolution of $\mathbf{B}G_{\text{ch}}$ we may form a compatible degreewise projective cofibrant resolution but then need to form not just the naive diagonal $\int^{\Delta} \Delta[-] \cdot (-)$ but the fattened diagonal $\int^{\Delta} \mathbf{\Delta}[-] \cdot (-)$. In the remainder of the proof we observe that for computing the left derived functor of \mathcal{O} , the fattened diagonal is not necessary after all.

For that observe that the functor

$$[\Delta^{\text{op}}, \mathcal{O}] : [\Delta^{\text{op}}, [\text{CartSp}_{\text{synthdiff}}^{\text{op}}, \text{sSet}]_{\text{proj,loc}}] \rightarrow [\Delta^{\text{op}}, (\text{SmoothAlg}^{\Delta})^{\text{op}}]$$

preserves Reedy cofibrant objects, because the left Quillen functor \mathcal{O} preserves colimits and cofibrations and hence the property that the morphisms $L_k X \rightarrow X_k$ out of latching objects $\lim_{\rightarrow s \dashrightarrow k} X_s$ are cofibrations.

Therefore we may again apply the Bousfield-Kan map after application of \mathcal{O} to find that there is a weak equivalence

$$(\mathbb{L}\mathcal{O})(\mathbf{BG}_{\text{ch}}) \simeq \int^{[k] \in \Delta} \Delta[k] \cdot \mathcal{O}((Q\mathbf{BG}_{\text{ch}})_k) \simeq \int^{[k] \in \Delta} \Delta[k] \cdot \mathcal{O}((Q\mathbf{BG}_{\text{ch}})_k)$$

in $(\text{SmoothAlg}^\Delta)^{\text{op}}$ to the object where the fat simplex is replaced back with the ordinary simplex. Therefore by prop. 4.5.42 the \mathbb{R} -cohomology that we are after is equivalently computed as the cochain cohomology of the image under the left adjoint

$$(N^\bullet)^{\text{op}} U^{\text{op}} : (\text{SmoothAlg}^\Delta)^{\text{op}} \rightarrow (\text{Ch}^\bullet)^{\text{op}}$$

(where $U : \text{SmoothAlg}^\Delta \rightarrow \text{Ab}^\Delta$ is the forgetful functor) of

$$\int^{[k] \in \Delta} \Delta[k] \cdot \mathcal{O}(Q\mathbf{BG}_{\text{ch}})_k \in (\text{SmoothAlg}^\Delta)^{\text{op}},$$

which is

$$(N^\bullet)^{\text{op}} \int^{[k] \in \Delta} \Delta[k] \cdot U^{\text{op}} \mathcal{O}((Q\mathbf{BG}_{\text{ch}})_k) \in (\text{Ch}^\bullet)^{\text{op}},$$

Notice that

1. for $S_{\bullet, \bullet}$ a bisimplicial abelian group we have that the coend $\int^{[k] \in \Delta} \Delta[k] \cdot S_{\bullet, k} \in (\text{Ab}^\Delta)^{\text{op}}$ is isomorphic to the diagonal simplicial abelian group and that forming diagonals of bisimplicial abelian groups sends degreewise weak equivalences to weak equivalences;
2. the Eilenberg-Zilber theorem asserts that the cochain complex of the diagonal is the total complex of the cochain bicomplex: $N^\bullet \text{diag} S_{\bullet, \bullet} \simeq \text{tot} C^\bullet(S_{\bullet, \bullet})$;
3. the complex $N^\bullet \mathcal{O}(Q\mathbf{BG}_{\text{ch}})_k$ – being the correct derived hom-space between $G^{\times k}$ and \mathbb{R} – is related by a zig-zag of weak equivalences to $\Gamma(G^{\times k}, I_{(k)})$, where $I_{(k)}$ is an injective resolution of the sheaf of abelian groups \mathbb{R}

Therefore finally we have

$$H_{\text{SynthDiff}}^n(G, \mathbb{R}) \simeq H_{\text{cochain}}^n \text{Tot} \Gamma(G^{\times \bullet}, I_{\bullet}).$$

On the right this is manifestly $H_{\text{Segal}}^n(G, \mathbb{R})$, as observed in [Bry00]. □

Corollary 4.5.44. *For G a compact Lie group we have for $n \geq 1$ that*

$$H_{\text{SynthDiff}\infty\text{Grpd}}^n(G, U(1)) \simeq H_{\text{Smooth}\infty\text{Grpd}}^n(G, U(1)) \simeq H_{\text{Top}}^{n+1}(BG, \mathbb{Z}).$$

Proof. For G compact we have, by [Blan85], that $H_{\text{Segal}}^n(G, \mathbb{R}) \simeq 0$. The claim then follows with prop. 4.5.43 and theorem 4.4.36 applied to the long exact sequence in cohomology induced by the short exact sequence $\mathbb{Z} \rightarrow \mathbb{R} \rightarrow \mathbb{R}/\mathbb{Z} = U(1)$. □

4.5.3.3 ∞ -Lie algebroid cohomology We discuss the intrinsic cohomology, 3.6.9, of ∞ -Lie algebroids, 4.5.1, in $\text{SynthDiff}\infty\text{Grpd}$.

Proposition 4.5.45. *Let $\mathfrak{a} \in L_\infty\text{Alg}$ be an L_∞ -algebroid. Then its intrinsic real cohomology in $\text{SynthDiff}\infty\text{Grpd}$*

$$H^n(\mathfrak{a}, \mathbb{R}) := \pi_0 \text{SynthDiff}\infty\text{Grpd}(\mathfrak{a}, \mathbf{B}^n \mathbb{R})$$

coincides with its ordinary L_∞ -algebroid cohomology: the cochain cohomology of its Chevalley-Eilenberg algebra

$$H^n(\mathfrak{a}, \mathbb{R}) \simeq H^n(\text{CE}(\mathfrak{a})).$$

Proof. By prop. 4.5.42 we have that

$$H^n(\mathfrak{a}, \mathbb{R}) \simeq H^n N^\bullet(\mathbb{L}\mathcal{O})(i(\mathfrak{a})).$$

By lemma 4.5.22 this is

$$\dots \simeq H^n N^\bullet \left(\int^{[k] \in \Delta} \Delta[k] \cdot \mathcal{O}(i(\mathfrak{a})_k) \right).$$

Observe that $\mathcal{O}(\mathfrak{a})_\bullet$ is cofibrant in the Reedy model structure $[\Delta^{\text{op}}, (\text{SmoothAlg}_{\text{proj}}^\Delta)^{\text{op}}]_{\text{Reedy}}$ relative to the opposite of the projective model structure on cosimplicial algebras: the map from the latching object in degree n in $\text{SmoothAlg}^\Delta{}^{\text{op}}$ is dually in $\text{SmoothAlg} \hookrightarrow \text{SmoothAlg}^\Delta$ the projection

$$\oplus_{i=0}^n \text{CE}(\mathfrak{a})_i \otimes \wedge^i \mathbb{R}^n \rightarrow \oplus_{i=0}^{n-1} \text{CE}(\mathfrak{a})_i \otimes \wedge^i \mathbb{R}^n$$

hence is a surjection, hence a fibration in $\text{SmoothAlg}_{\text{proj}}^\Delta$ and therefore indeed a cofibration in $(\text{SmoothAlg}_{\text{proj}}^\Delta)^{\text{op}}$.

Therefore using the Quillen bifunctor property of the coend over the tensoring in reverse to lemma 4.5.22 the above is equivalent to

$$\dots \simeq H^n N^\bullet \left(\int^{[k] \in \Delta} \Delta[k] \cdot \mathcal{O}(i(\mathfrak{a})_k) \right)$$

with the fat simplex replaced again by the ordinary simplex. But in brackets this is now by definition the image under the monoidal Dold-Kan correspondence of the Chevalley-Eilenberg algebra

$$\dots \simeq H^n(N^\bullet \Xi \text{CE}(\mathfrak{a})).$$

By the Dold-Kan correspondence we have hence

$$\dots \simeq H^n(\text{CE}(\mathfrak{a})).$$

□

Remark 4.5.46. It follows that an intrinsically defined degree- n \mathbb{R} -cocycle on \mathfrak{a} is indeed presented by a morphism in $L_\infty \text{Alg}$

$$\mu : \mathfrak{a} \rightarrow b^n \mathbb{R},$$

as in def. 4.4.102. Notice that if $\mathfrak{a} = b\mathfrak{g}$ is the delooping of an L_∞ -algebra \mathfrak{g} this is equivalently a morphism of L_∞ -algebras

$$\mu : \mathfrak{g} \rightarrow b^{n-1} \mathbb{R}.$$

4.5.4 Extensions of L_∞ -algebroids

We discuss the general notion of extensions of cohesive ∞ -groups, 3.6.14, for infinitesimal objects in $\text{SynthDiff} \infty \text{Grpd}$: extensions of L_∞ -algebras, def. 4.5.12.

Proposition 4.5.47. *Let $\mu : b\mathfrak{g} \rightarrow b^{n+1} \mathbb{R}$ be an $(n+1)$ -cocycle on an L_∞ -algebra \mathfrak{g} . Then under the embedding of def. 4.5.21 the L_∞ -algebra \mathfrak{g}_μ of def. 4.4.105 is the extension classified by μ , according to the general definition 3.6.242.*

Proof. We need to show that

$$b\mathfrak{g}_\mu \rightarrow \mathfrak{g} \xrightarrow{\mu} b^{n+1} \mathbb{R}$$

is a fiber sequence in $\text{SynthDiff}\infty\text{Grpd}$. By prop. 4.4.110 this sits in a pullback diagram of L_∞ -algebras (connected L_∞ -algebroids)

$$\begin{array}{ccc} b\mathfrak{g}_\mu & \longrightarrow & eb^n\mathbb{R} \\ \downarrow & & \downarrow \\ b\mathfrak{g} & \xrightarrow{\mu} & b^{n+1}\mathbb{R} \end{array} .$$

By prop. 4.5.20 this pullback is preserved by the embedding into $[\text{CartSp}_{\text{synthdiff}}^{\text{op}}, \text{sSet}]_{\text{proj}}$. Here the right vertical morphism is found to be a fibration replacement of the point inclusion $* \rightarrow b^{n+1}\mathbb{R}$. By the discussion in 2.3.2.1 this identifies $b\mathfrak{g}_\mu$ as the homotopy fiber of μ . \square

4.5.5 Infinitesimal path groupoid and de Rham spaces

We discuss the intrinsic notion of infinitesimal geometric paths in objects in a ∞ -topos of infinitesimal cohesion, 3.10.1, realized in $\text{SynthDiff}\infty\text{Grpd}$.

Observation 4.5.48. For $U \times D \in \text{CartSp}_{\text{smooth}} \times \text{InfinSmoothLoc} = \text{CartSp}_{\text{synthdiff}} \hookrightarrow \text{SynthDiff}\infty\text{Grpd}$ we have that

$$\mathbf{Red}(U \times D) \simeq U$$

is the *reduced smooth locus*: the formal dual of the smooth algebra obtained by quotienting out all nilpotent elements in the smooth algebra $C^\infty(K \times D) \simeq C^\infty(K) \otimes C^\infty(D)$.

Proof. By the model category presentation of $\mathbf{Red} = \mathbb{L}\text{Lan}_i \circ \mathbb{R}i^*$ of the proof of prop. 4.5.11 and using that every representable is cofibrant and fibrant in the local projective model structure on simplicial presheaves we have

$$\begin{aligned} \mathbf{Red}(U \times D) &\simeq (\mathbb{L}\text{Lan}_i)(\mathbb{R}i^*)(U \times D) \\ &\simeq (\mathbb{L}\text{Lan}_i)i^*(U \times D) \\ &\simeq (\mathbb{L}\text{Lan}_i)U \quad , \\ &\simeq \text{Lan}_i U \\ &\simeq U \end{aligned}$$

where we are using again that i is a full and faithful functor. \square

Corollary 4.5.49. For $X \in \text{SmoothAlg}^{\text{op}} \rightarrow \text{SynthDiff}\infty\text{Grpd}$ a smooth locus, we have that $\mathbf{\Pi}_{\text{inf}}(X)$ is the corresponding de Rham space, the object characterized by

$$\text{SynthDiff}\infty\text{Grpd}(U \times D, \mathbf{\Pi}_{\text{inf}}(X)) \simeq \text{SmoothAlg}^{\text{op}}(U, X) .$$

Proof. By the $(\mathbf{Red} \dashv \mathbf{\Pi}_{\text{inf}})$ -adjunction relation we have

$$\begin{aligned} \text{SynthDiff}\infty\text{Grpd}(U \times D, \mathbf{\Pi}_{\text{inf}}(X)) &\simeq \text{SynthDiff}\infty\text{Grpd}(\mathbf{Red}(U \times D), X) \\ &\simeq \text{SynthDiff}\infty\text{Grpd}(U, X) \end{aligned} .$$

\square

4.5.6 Formally smooth/étale/unramified morphisms

We discuss the general notion of formally smooth/étale/unramified morphisms, 3.10.4, realized in the differential ∞ -topos $i : \text{Smooth}\infty\text{Grpd} \hookrightarrow \text{SynthDiff}\infty\text{Grpd}$. given by prop. 4.5.11.

Proposition 4.5.50. *A morphism $f : X \rightarrow Y$ in $\text{SynthDiff}\infty\text{Grpd}$ is formally étale in the general sense of def. 3.10.19 precisely if for all infinitesimal thickenings $D \in \text{InfSmoothLoc} \hookrightarrow \text{SynthDiff}\infty\text{Grpd}$ the canonical diagrams*

$$\begin{array}{ccc} X^D & \xrightarrow{f^D} & Y^D \\ \downarrow & & \downarrow \\ X & \xrightarrow{f} & Y \end{array}$$

(where the vertical morphisms are induced by the unique point inclusion $* \rightarrow D$) are ∞ -pullbacks under i^* .

Proof. We will write $i : \mathbf{H} \hookrightarrow \mathbf{H}_{\text{th}}$ as shorthand for $i : \text{Smooth}\infty\text{Grpd} \hookrightarrow \text{SynthDiff}\infty\text{Grpd}$. The defining ∞ -pullback diagram of def. 3.10.19 induces and is detected by ∞ -pullback diagrams for all $U \times D \in \text{CartSp}_{\text{SynthDiff}}$ of the form

$$\begin{array}{ccc} \mathbf{H}_{\text{th}}(U \times D, X) & \longrightarrow & \mathbf{H}_{\text{th}}(U \times D, Y) \\ \downarrow & & \downarrow \\ \mathbf{H}_{\text{th}}(U \times D, i_* i^* X) & \longrightarrow & \mathbf{H}_{\text{th}}(U \times D, i_* i^* Y) \end{array}$$

By the ∞ -Yoneda lemma, the $(i^* \dashv i_*)$ -adjunction, the definition of i and the formula for the internal hom, this is equivalent to the diagram

$$\begin{array}{ccc} \mathbf{H}(U, i^* X^D) & \longrightarrow & \mathbf{H}(U, i^* Y^D) \\ \downarrow & & \downarrow \\ \mathbf{H}(U, i^* X) & \longrightarrow & \mathbf{H}(U, i^* Y) \end{array}$$

being an ∞ -pullback for all $U \in \text{CartSp}$. By one more application of the ∞ -Yoneda lemma this is the statement to be proven. \square

Remark 4.5.51. Since i^* is right adjoint and hence preserves ∞ -pullbacks, it is sufficient for a morphism $f \in \text{SynthDiff}\infty\text{Grpd}$ to be formally étale that

$$\begin{array}{ccc} X^D & \xrightarrow{f^D} & Y^D \\ \downarrow & & \downarrow \\ X & \xrightarrow{f} & Y \end{array}$$

is an ∞ -pullback in $\text{SynthDiff}\infty\text{Grpd}$. In this form, when restricted to 0-truncated objects, formally étale morphisms are axiomatized in [Kock06], around p. 82, in a topos for synthetic differential geometry, such as the Cahier topos $\tau_{\leq 0}\text{SynthDiff}\infty\text{Grpd} \simeq \text{Sh}(\text{CartSp})$ considered here.

We now discuss in more detail the special case of formally étale maps between objects that are presented by simplicial smooth manifolds.

Proposition 4.5.52. *Let $X \in \text{Smooth}\infty\text{Grpd}$ be presented by a simplicial smooth manifold under the canonical inclusion $X_\bullet \in \text{SmthMfd}^{\Delta^{\text{op}}} \hookrightarrow [\text{CartSp}_{\text{smooth}}^{\text{op}}, \text{sSet}]$. Then $i_!X$ is presented by the same simplicial smooth manifold, under the canonical inclusion*

$$X_\bullet \in \text{SmthMfd}^{\Delta^{\text{op}}} \hookrightarrow [\text{CartSp}_{\text{synthdiff}}^{\text{op}}, \text{sSet}].$$

Proposition 4.5.53. *Let $f : X \rightarrow Y$ be a morphism in SmthMfd , a smooth function between finite dimensional paracompact smooth manifolds, regarded, by cor. 4.4.10, as a morphism in $\text{Smooth}\infty\text{Grpd}$. Then*

- f is a submersion $\Leftrightarrow f$ is formally i -smooth;
- f is a local diffeomorphism $\Leftrightarrow f$ is formally i -étale;
- f is an immersion $\Leftrightarrow f$ is formally i -unramified;

where on the left we have the traditional notions, and on the right those of def. 3.10.16.

Proof. By lemma 4.5.52 the canonical diagram

$$\begin{array}{ccc} i_!X & \xrightarrow{i_!f} & i_!Y \\ \downarrow & & \downarrow \\ i_*X & \xrightarrow{i_*f} & i_*Y \end{array}$$

in $\text{SynthDiff}\infty\text{Grpd}$ is presented in $[\text{CartSp}_{\text{synthdiff}}^{\text{op}}, \text{sSet}]_{\text{proj,loc}}$ by the diagram of presheaves

$$U \times D \mapsto \begin{array}{ccc} \text{FSmthMfd}(U \times D, X) & \xrightarrow{\text{FSmthMfd}(U \times D, f)} & \text{FSmthMfd}(U \times D, Y) \\ \downarrow & & \downarrow \\ \text{FSmthMfd}(U, X) & \xrightarrow{\text{FSmthMfd}(U, f)} & \text{FSmthMfd}(U, Y) \end{array},$$

where FSmthMfd is the category of formal smooth manifolds from def. 4.5.9, U is an ordinary smooth manifold and D an infinitesimal smooth loci, def. 4.5.5.

Consider this first for the case that $D := \mathbb{D} \hookrightarrow \mathbb{R}$ is the first order infinitesimal neighbourhood of the origin in the real line. Restricted to this case the above diagram of presheaves is that represented on SmthMfd by the diagram of smooth manifolds

$$\begin{array}{ccc} TX & \xrightarrow{df} & TY \\ \downarrow & & \downarrow \\ X & \xrightarrow{f} & Y \end{array},$$

where on the top we have the tangent bundles of X and Y and the differential of f mapping between them.

Since pullbacks of presheaves are computed objectwise, f being formally smooth/étale/unramified implies that the canonical morphism

$$TX \rightarrow X \times_Y TY = f^*TY$$

is an epi-/iso-/mono-morphism, respectively. This by definition means that f is a submersion/local diffeomorphism/immersion, respectively.

Conversely, by standard facts of differential geometry, f being a submersion means that it is locally a projection, f being a local isomorphism means that it is in particular étale, and f being an immersion means

that it is locally an embedding. This implies that also for D any other infinitesimal smooth locus, so that X^D, Y^D are bundles of possibly higher order formal curves, the morphism

$$X^D \rightarrow X \times_Y Y^D$$

is an epi-/iso-/mono-morphism, respectively. □

4.5.7 Formally étale groupoids

We discuss the general notion of formally étale groupoids in a differential ∞ -topos, 3.10.5, realized in $\text{Smooth}\infty\text{Grpd} \xrightarrow{i} \text{SynthDiff}\infty\text{Grpd}$.

Definition 4.5.54. Call a simplicial smooth manifold $X \in \text{SmoothMfd}^{\Delta^{\text{op}}}$ an *étale simplicial smooth manifold* if it is fibrant as an object of $[\text{CartSp}^{\text{op}}, \text{sSet}]_{\text{proj}}$ and if moreover all face and degeneracy morphisms are étale morphisms.

Example 4.5.55. The nerve of an étale Lie groupoid in the traditional sense is an étale simplicial smooth manifold.

Proposition 4.5.56. *Let $X \in \text{SmothMfd}^{\Delta^{\text{op}}}$ be an étale simplicial manifold, def. 4.5.54. Then equipped with its canonical atlas, observation 2.3.29, it presents a formally étale groupoid object in $\text{Smooth}\infty\text{Grpd} \xrightarrow{i} \text{SynthDiff}\infty\text{Grpd}$, according to def. 3.10.33.*

Proof. We need to check that $i_!X_0$ is the ∞ -pullback $i_*X_0 \times_{i_*X} i_!X$. By prop. 2.3.13, lemma 4.5.52 and prop. 2.3.33 it is sufficient to show for the décalage replacement $\text{Dec}_0X \rightarrow X$ of the atlas, that $i_!\text{Dec}_0X$ is the ordinary pullback of simplicial presheaves $(i_*\text{Dec}_0X) \times_{i_*X} i_!X$. Since pullbacks of simplicial presheaves are computed degreewise, this is the case by prop. 4.5.53 if for all $n \in \mathbb{N}$ the morphism $(\text{Dec}_0X)_n \rightarrow X_n$ is an étale morphism of smooth manifolds, in the traditional sense. By prop. 2.3.32 this morphism is the face map d_{n+1} of X . This is indeed étale by the very assumption that X is an étale simplicial smooth manifold. □

4.5.8 Chern-Weil theory

We discuss the notion of ∞ -connections, 4.4.17, in the context $\text{SynthDiff}\infty\text{Grpd}$.

4.5.8.1 ∞ -Cartan connections A *Cartan connection* on a smooth manifold is a principal connection subject to an extra constraint that identifies a component of the connection at each point with the tangent space of the base manifold at that point. The archetypical application of this notion is to the formulation of the field theory of *gravity*, 5.2.8.1.

We indicate a notion of Cartan ∞ -connections.

The following notion is classical, see for instance section 5.1 of [Sha97].

Definition 4.5.57. Let $(H \hookrightarrow G)$ be an inclusion of Lie groups with Lie algebras $(\mathfrak{h} \hookrightarrow \mathfrak{g})$. A $(H \rightarrow G)$ -*Cartan connection* on a smooth manifold X is

1. a G -principal bundle $P \rightarrow X$ equipped with a connection ∇ ;
2. such that
 - (a) the structure group of P reduces to H , hence the classifying morphism factors as $X \rightarrow \mathbf{B}H \rightarrow \mathbf{B}G$;

(b) for each point $x \in X$ and any local trivialization of (P, ∇) in some neighbourhood of X , the canonical linear map

$$T_x X \xrightarrow{\nabla} \mathfrak{g} \longrightarrow \mathfrak{g}/\mathfrak{h}$$

is an isomorphism,

Here $(\mathfrak{h} \rightarrow \mathfrak{g})$ are the Lie algebras of the given Lie groups and $\mathfrak{g}/\mathfrak{h}$ is the quotient of the underlying vector spaces.

4.6 Supergeometric ∞ -groupoids

We discuss ∞ -groupoids equipped with *discrete super cohesion*, with *smooth super cohesion* and *synthetic differential super cohesion*, where “super” is in the sense of *superalgebra* and *supergeometry* (see for instance [DeLMor99] for a review of traditional superalgebra and supergeometry).

4.6.1 Survey

We first introduce *discrete super ∞ -groupoids* which have super-grading but no smooth structure. This is the canonical context in which (higher) *superalgebra* takes place: an \mathbb{R} -module internal to super ∞ -groupoids is externally a chain complex of *super vector spaces* and an \mathbb{R} -algebra internal to super ∞ -groupoids is externally a real *superalgebra*. Then we add smooth structure by passing further to *smooth super ∞ -groupoids*. This is the canonical context for supergeometry. Notably the traditional category of smooth supermanifolds faithfully embeds into smooth super ∞ -groupoids. Finally we further refine to *synthetic differential super ∞ -groupoids* where the smooth structure is refined by explicit commutative infinitesimals in addition to the super/graded infinitesimals of supergeometry. In summary, this yields a super-refinement of three cohesive structures discussed before:

supergeometric refinement	differential geometry	discussed in section
Super ∞ Grpd	Disc ∞ Grpd	4.2
SmoothSuper ∞ Grpd	Smooth ∞ Grpd	4.4
SynthDiffSuper ∞ Grpd	SynthDiff ∞ Grpd	4.5

Accordingly, the canonical site of definition of the most inclusive of these cohesive ∞ -toposes, which is SynthDiffSuper ∞ Grpd, contains objects denoted $\mathbb{R}^{p\oplus s|q}$ – *synthetic differential super Cartesian space* – that have three gradings:

- an ordinary dimension p ;
- an order s of their infinitesimal thickening;
- an odd super dimension q .

In terms of the formally dual function algebras $C^\infty(\mathbb{R}^{p\oplus k|l})$ on these objects, k is the number of *commuting* nilpotent generators, while q is the number of *graded-commuting* nilpotent generators. In this sense supergeometry may be understood as a \mathbb{Z}_2 -graded variant of synthetic differential geometry. This is a perspective that had been explored in [Yet88] and more recently in [CaRo12].

Of course ∞ -groupoids X over this synthetic supergeometric site have furthermore their homotopy theoretic degree, their simplicial grading when modeled by simplicial presheaves

$$X : (\mathbb{R}^{p\oplus s|q}, \Delta^k) \mapsto X_k(\mathbb{R}^{p\oplus s|q}) \in \text{Set}.$$

While for some applications it is useful to regard all these “kinds of dimension” as being on equal footing, for other applications it is useful to order them more hierarchically. Specifically the role played by supergeometry in applications is well reflected by the perspective where smooth/synthetic differential supergeometry is regarded as ordinary smooth/synthetic differential geometry but *internal* to the “bare super context”, which is the context parameterized over just the *superpoints* $\mathbb{R}^{0|q}$. This perspective on supergeometry had been proposed independently in 1984 in [Schw84], [Mol84] and [Vor84]. A review is in the appendix of [KonSch00], whose main part discusses aspects of those synthetic differential superspaces in this language.

In terms of (higher) topos theory this perspective means that passing from higher differential geometry to higher supergeometry means to change the *base ∞ -topos* from that of ordinary geometrically discrete ∞ -groupoids $\text{Disc}\infty\text{Grpd} \simeq \infty\text{Grpd} \simeq L_{\text{whe}}\text{Top}$ to that of “super ∞ -groupoids” $\text{Super}\infty\text{Grpd} := \text{Sh}_\infty(\{\mathbb{R}^{0|q}\}_q)$ which still have no finite continuous/smooth geometric structure but which do have super-grading.

We find below the ∞ -toposes for differential-, synthetic differential- and supergeometry to arrange in a diagram of geometric morphisms of the form

$$\begin{array}{ccccc} \text{SmoothSuper}\infty\text{Grpd} & \hookrightarrow & \text{SynthDiffSuper}\infty\text{Grpd} & \longrightarrow & \text{Super}\infty\text{Grpd} \\ \downarrow & & \downarrow & & \downarrow \\ \text{Smooth}\infty\text{Grpd} & \hookrightarrow & \text{SynthDiff}\infty\text{Grpd} & \longrightarrow & \infty\text{Grpd} \end{array} .$$

Here the bottom line is the differential cohesion over the base of discrete ∞ -groupoids discussed in 4.5. The top line is the super-refinement exhibited by differential cohesion, but now over the base $\text{Super}\infty\text{Grpd}$ of discrete but “super” ∞ -groupoids. This diagram of ∞ -toposes we present by a diagram of sites which, with the above notation for synthetic differential super Cartesian spaces, looks as follows.

$$\begin{array}{ccccc} \{\mathbb{R}^{p|q}\}_{p,q} & \hookrightarrow & \{\mathbb{R}^{p\oplus s|q}\}_{p,s,q} & \longrightarrow & \{\mathbb{R}^{0|q}\}_q \\ \downarrow & & \downarrow & & \downarrow \\ \{\mathbb{R}^p\}_p & \hookrightarrow & \{\mathbb{R}^{p\oplus s}\}_{p,s} & \longrightarrow & \{*\} \end{array} .$$

4.6.2 The ∞ -topos of supergeometric ∞ -stacks

Definition 4.6.1. Let $\text{GrassmannAlg}_{\mathbb{R}}$ be the category whose objects are finite dimensional free \mathbb{Z}_2 -graded commutative \mathbb{R} -algebras (Grassmann algebras). Write

$$\text{SuperPoint} := \text{GrassmannAlg}_{\mathbb{R}}^{\text{op}}$$

for its opposite category. For $q \in \mathbb{N}$ we write $\mathbb{R}^{0|q} \in \text{SuperPoint}$ for the object corresponding to the free \mathbb{Z}_2 -graded commutative algebra on q generators and speak of the *superpoint* of order q .

We think of SuperPoint as a site by equipping it with the trivial coverage.

Definition 4.6.2. Write

$$\text{SuperSet} := \text{Sh}(\text{SuperPoint}) \simeq \text{PSh}(\text{SuperPoint})$$

for the topos of presheaves over SuperPoint .

Definition 4.6.3. Write

$$\text{Super}\infty\text{Grpd} := \text{Sh}_{\infty}(\text{SuperPoint}) \simeq \text{PSh}_{\infty}(\text{SuperPoint})$$

for the ∞ -topos of ∞ -sheaves over SuperPoint . We say an object $X \in \text{Super}\infty\text{Grpd}$ is a *super ∞ -groupoid*.

Proposition 4.6.4. *The ∞ -topos $\text{Super}\infty\text{Grpd}$ is infinitesimal cohesive, def. 3.5 over ∞Grpd .*

Proof. The ordinary point in SuperPoint is both the terminal object but also the initial object, since superpoints are infinitesimally thickened points in that they only have one global actual point. Therefore the statement follows with prop. 3.4.13. \square

We regard higher superalgebra and higher supergeometry as being the higher algebra and geometry *over the base ∞ -topos* ([Joh02], chapter B3) $\text{Super}\infty\text{Grpd}$ instead of over the canonical base ∞ -topos ∞Grpd . Except for the topos-theoretic rephrasing, this perspective has originally been suggested in [Schw84] and [Mol84].

Proposition 4.6.5. *The ∞ -topos $\text{Super}\infty\text{Grpd}$ is cohesive, def. 3.4.1.*

$$\text{Super}\infty\text{Grpd} \begin{array}{c} \xrightarrow{\Pi} \\ \xleftarrow{\text{Disc}} \\ \xrightarrow{\Gamma} \\ \xleftarrow{\text{coDisc}} \end{array} \infty\text{Grpd} .$$

Proof. The site SuperPoint is ∞ -cohesive, according to def. 3.4.17. Hence the claim follows by prop. 3.4.18. \square

Proposition 4.6.6. *The inclusion $\text{Disc} : \infty\text{Grpd} \hookrightarrow \text{Super}\infty\text{Grpd}$ exhibits the collection of super ∞ -groupoids as forming an infinitesimal cohesive neighbourhood, def. 3.5.1, of the discrete ∞ -groupoids, 4.2.*

Proof. Observe that the point inclusion $i : \text{Point} := * \hookrightarrow \text{SuperPoint}$ is both left and right adjoint to the unique projection $p : \text{SuperPoint} \rightarrow \text{Point}$. Therefore we have even a periodic sequence of adjunctions

$$(\cdots \dashv i^* \dashv p^* \dashv i^* \dashv p^* \dashv \cdots) : \text{Super}\infty\text{Grpd} \rightarrow \infty\text{Grpd},$$

and $p^* \simeq \text{Disc} \simeq \text{coDisc}$ is full and faithful. \square

Definition 4.6.7. Write $\mathbb{R} \in \text{Super}\infty\text{Grpd}$ for the presheaf $\text{SuperPoint}^{\text{op}} \rightarrow \text{Set} \hookrightarrow \infty\text{Grpd}$ given by

$$\mathbb{R} : \mathbb{R}^{0|q} \mapsto C^\infty(\mathbb{R}^{0|q}) := (\Lambda_q)_{\text{even}},$$

which sends the order- q superpoint to the underlying set of the even subalgebra of the Grassmann algebra on q generators.

Remark 4.6.8. The object $\mathbb{R} \in \text{Super}\infty\text{Grpd}$ is canonically equipped with the structure of an internal ring object. Moreover, under both Π and Γ it maps to the ordinary real line $\mathbb{R} \in \text{Set} \hookrightarrow \infty\text{Grpd}$ while respecting the ring structures on both sides.

The following observation is due to [Mol84].

Proposition 4.6.9. *The theory of ordinary (linear) \mathbb{R} -algebra internal to the 1-topos*

$$\text{SuperSet} = \text{Super0Grpd} \hookrightarrow \text{Super}\infty\text{Grpd}$$

is equivalent to the theory of \mathbb{R} -superalgebra in Set.

Definition 4.6.10. Write sCartSp for the full subcategory of that of supermanifolds on those that are super Cartesian spaces: $\{\mathbb{R}^{p|q}\}_{p,q \in \mathbb{N}}$. Regard this as a site by equipping it with the coverage whose covering families are of the form $\{U_i \times \mathbb{R}^{0|q} \xrightarrow{(p_i, \text{id})} \mathbb{R}^{p|q}\}$ for $\{U_i \rightarrow \mathbb{R}^p\}$ a differentiably good open cover, def. 4.4.2.

Remark 4.6.11. A morphism $\mathbb{R}^{p_1|q_1} \rightarrow \mathbb{R}^{p_2|q_2}$ in $\text{CartSp}_{\text{super}}$ is equivalently a tuple consisting of p_2 even elements and q_2 odd elements of the superalgebra $C^\infty(\mathbb{R}^{p_1|q_1})$. In particular, under the restricted Yoneda embedding the line of def. 4.6.7 is $\mathbb{R} \simeq \mathbb{R}^{1|0}$.

Definition 4.6.12. Write

$$\text{SmoothSuper}\infty\text{Grpd} := \text{Sh}_\infty(\text{sCartSp}_{\text{smooth}}).$$

An object in this ∞ -topos we call a *smooth super ∞ -groupoid*.

Proposition 4.6.13. *We have a commuting diagram of cohesive ∞ -toposes which exhibits $\text{Super}\infty\text{Grpd}$ as an ∞ -pushout*

$$\begin{array}{ccc}
 & \begin{array}{c} \xrightarrow{\Pi_{\text{super}}} \\ \times \text{Disc}_{\text{super}} \\ \xleftarrow{\Gamma_{\text{super}}} \\ \xleftarrow{\text{coDisc}_{\text{super}}} \end{array} & \text{Super}\infty\text{Grpd} \\
 \begin{array}{c} \uparrow \\ \downarrow \\ \uparrow \\ \downarrow \\ \uparrow \\ \downarrow \end{array} & & \begin{array}{c} \uparrow \\ \downarrow \\ \uparrow \\ \downarrow \\ \uparrow \\ \downarrow \end{array} \\
 \text{Smooth}\infty\text{Grpd} & \begin{array}{c} \xrightarrow{\Pi} \\ \times \text{Disc} \\ \xleftarrow{\Gamma} \\ \xleftarrow{\text{coDisc}} \end{array} & \infty\text{Grpd}
 \end{array}$$

Proof. By def. 4.6.10 the arguments of 4.4 apply verbatim at the stage of each fixed superpoint, and this gives the cohesion over $\text{Super}\infty\text{Grpd}$, hence the top vertical adjoint quadruple in the above. The right vertical morphisms exhibit infinitesimal cohesion by prop. 4.6.4. That the resulting diagram is an ∞ -pushout follows now with the same argument as in the proof of prop. 4.5.35. \square

For emphasis we shall refer to the objects of $\text{Super}\infty\text{Grp}$ as *discrete super ∞ -groupoids*: these refine discrete ∞ -groupoids, 4.2 with super-cohesion and are themselves further refined by smooth super ∞ -groupoids with smooth cohesion.

We now discuss the various general abstract structures in a cohesive ∞ -topos, 3.9, realized in $\text{Super}\infty\text{Grpd}$ and $\text{SmoothSuper}\infty\text{Grpd}$.

- 4.6.3 – Associated bundles
- 4.6.4 – Exponentiated ∞ -Lie algebras

4.6.3 Associated bundles

We discuss aspects of the general notion of associated fiber ∞ -bundles, 3.6.11, realized in the context of supergeometric cohesion.

In 4.4.10 above we discussed the 2-stack $2\mathbf{Line}_{\mathbb{C}}$ of smooth complex line 2-bundles. Since the B -field that the bosonic string is charged under has moduli in the differential refinement $\mathbf{B}^2\mathbb{C}_{\text{conn}}^{\times}$, we may hence say that it is given by 2-connections on complex *2-line bundles*. However, a careful analysis (due [DiFrMo11] and made more explicit in [Fr99]) shows that for the superstring the background B -field is more refined. Expressed in the language of higher stacks the statement is that it is a connection on a complex *super-2-line bundle*. Precisely, in the language of stacks for supergeometry we are to pass to the higher topos $\text{SmoothSuper}\infty\text{Grpd} \simeq \text{Sh}_{\infty}(\text{SuperMfd})$ on the site of smooth supermanifolds, 4.6. Internal to that the term *algebra* now means *superalgebra* and hence the 2-stack

$$2\mathbf{sLine}_{\mathbb{C}} \in \text{SmoothSuper}\infty\text{Grpd}$$

now has global points that are identified with complex Azumaya *superalgebras*. Of these it turns out there is, up to equivalence, not just one, but two: the canonical super 2-line and its “superpartner”. Moreover, there are now, up to equivalence, two different invertible 2-linear maps from each of these super-lines to itself. In summary, the homotopy sheaves of the super 2-stack of super line 2-bundles are

- $\pi_0(2\mathbf{sLine}_{\mathbb{C}}) \simeq \mathbb{Z}_2$,
- $\pi_1(2\mathbf{sLine}_{\mathbb{C}}) \simeq \mathbb{Z}_2$,
- $\pi_2(2\mathbf{sLine}_{\mathbb{C}}) \simeq \mathbb{C}^{\times} \in \text{Sh}(\text{SuperMfd})$.

(where in the last line we emphasize that the *homotopy sheaf* is that represented by \mathbb{C}^{\times} as a smooth (super-)manifold). With the discussion in 3.8.1 it follows that the geometric realization of this 2-stack has homotopy groups

- $\pi_0(|2\mathbf{sLine}_{\mathbb{C}}|) \simeq \mathbb{Z}_2$,
- $\pi_1(|2\mathbf{sLine}_{\mathbb{C}}|) \simeq \mathbb{Z}_2$,
- $\pi_2(|2\mathbf{sLine}_{\mathbb{C}}|) \simeq 0$,
- $\pi_3(|2\mathbf{sLine}_{\mathbb{C}}|) \simeq \mathbb{Z}$.

These are precisely the correct coefficients for the twists of complex K-theory, witnessing the fact that the B-field background of the superstring twists the Chan-Paton bundles on the D-branes.

The braided monoidal structure of $2\mathbf{sVect}_{\mathbb{C}}$ induces on $2\mathbf{sLine}_{\mathbb{C}}$ the structure of a *braided 3-group*. Therefore the above general abstract definition of universal moduli for differential cocycles/higher connections produces a moduli 3-stack $\mathbf{B}(2\mathbf{sLine}_{\mathbb{C}})_{\text{conn}}$ which is the supergeometric refinement of the coefficient object $\mathbf{B}^3\mathbb{C}_{\text{conn}}^{\times}$ for the extended Lagrangian of bosonic 3-dimensional Chern-Simons theory. Therefore for G a super-Lie group a super-Chern-Simons theory that induces the super-WZW action functional on G is given by an extended Lagrangian which is a map of higher moduli stacks of the form

$$\mathbf{L} : \mathbf{B}G_{\text{conn}} \longrightarrow \mathbf{B}(2\mathbf{sLine}_{\mathbb{C}})_{\text{conn}} .$$

By the canonical inclusion $\mathbf{B}^3\mathbb{C}_{\text{conn}}^{\times} \rightarrow \mathbf{B}(2\mathbf{sLine}_{\mathbb{C}})_{\text{conn}}$ every bosonic extended Lagrangian of 3-d Chern-Simons type induces such a supergeometric theory with trivial super-grading part.

4.6.4 Exponentiated ∞ -Lie algebras

According to prop. 4.6.9 the following definition is justified.

Definition 4.6.14. A *super L_{∞} -algebra* is an L_{∞} -algebra, def. 1.2.143, internal to the topos SuperSet, def. 4.6.2, over the ring object \mathbb{R} from def. 4.6.7.

Observation 4.6.15. The Chevalley-Eilenberg algebra $\text{CE}(\mathfrak{g})$, def. 1.2.146, of a super L_{∞} -algebra \mathfrak{g} is externally

- a graded-commutative algebra over \mathbb{R} on generators of bigree in $(\mathbb{N}_+, \mathbb{Z}_2)$ – the *homotopical degree* deg_h and the *super degree* deg_s ;
- such that for any two generators a, b the product satisfies

$$ab = (-1)^{\text{def}_h(a)\text{deg}_h(b) + \text{def}_s(a)\text{deg}_s(b)} ba ;$$

- and equipped with a differential d_{CE} of bidegree $(1, \text{even})$ such that $d_{\text{CE}}^2 = 0$.

Examples 4.6.16. • Every ordinary L_{∞} -algebra is canonically a super L_{∞} -algebra where all elements are of even superdegree.

- Ordinary super Lie algebras are canonically identified with precisely the super Lie 1-algebras.
- For every $n \in \mathbb{N}$ there is the *super line super Lie $(n+1)$ -algebra* $b^n\mathbb{R}^{0|1}$ characterized by the fact that its Chevalley-Eilenberg algebra has trivial differential and a single generator in bidegree (n, odd) .
- For \mathfrak{g} any super L_{∞} -algebra and $\mu : \mathfrak{g} \rightarrow b^n\mathbb{R}$ a cocycle, its homotopy fiber is the super L_{∞} -algebra extension of \mathfrak{g} , as in def. 4.4.105.

Below in 5.2.8.2 we discuss in detail a class of super L_{∞} -algebras that arise by higher extensions from a super Poincaré Lie algebra.

Observation 4.6.17. The Lie integration

$$\exp(\mathfrak{g}) \in [\text{CartSp}_{\text{smooth}} \times \text{SuperPoint}, \text{sSet}] = [\text{SuperPoint}, [\text{CartSp}_{\text{smooth}}, \text{sSet}]]$$

of a super L_{∞} -algebra \mathfrak{g} according to 4.4.14 is a system of Lie integrated ordinary L_{∞} -algebras

$$\exp(\mathfrak{g}) : \mathbb{R}^{0|q} \mapsto \exp((\mathfrak{g} \otimes_{\mathbb{R}} \Lambda_q)_{\text{even}}) ,$$

where $\Lambda_q = C^{\infty}(\mathbb{R}^{0|q})$ is the Grassmann algebra on q generators.

Over each $U \in \text{CartSp}$ this is the discrete super ∞ -groupoid given by

$$\exp(\mathfrak{g})_U : \mathbb{R}^{0|q} \mapsto \text{Hom}_{\text{dgsAlg}}(\text{CE}(\mathfrak{g} \otimes \Lambda_q)_{\text{even}}, \Omega_{\text{vert}}^{\bullet}(U \times \mathbb{R}^{0|q} \times \Delta^{\bullet})) ,$$

where on the right we have super differential forms vertical with respect to the projection $U \times \mathbb{R}^{0|q} \times \Delta^n \rightarrow U \times \mathbb{R}^{0|q}$ of supermanifolds.

Proof. The first statement holds by the proof of prop. 4.6.9. The second statement is an example of a standard mechanism in superalgebra: Using that the category \mathbf{sVect} of finite-dimensional super vector space is a compact closed category, we compute

$$\begin{aligned}
\mathrm{Hom}_{\mathrm{dgsAlg}}(\mathrm{CE}(\mathfrak{g}), \Omega_{\mathrm{vert}}^{\bullet}(U \times \mathbb{R}^{0|q} \times \Delta^n)) &\simeq \mathrm{Hom}_{\mathrm{dgsAlg}}(\mathrm{CE}(\mathfrak{g}), C^{\infty}(\mathbb{R}^{0|q}) \otimes \Omega_{\mathrm{vert}}^{\bullet}(U \times \Delta^n)) \\
&\simeq \mathrm{Hom}_{\mathrm{dgsAlg}}(\mathrm{CE}(\mathfrak{g}), \Lambda_q \otimes \Omega_{\mathrm{vert}}^{\bullet}(U \times \Delta^n)) \\
&\subset \mathrm{Hom}_{\mathrm{Ch}^{\bullet}(\mathbf{sVect})}(\mathfrak{g}^*[1], \Lambda_q \otimes \Omega_{\mathrm{vert}}^{\bullet}(U \times \Delta^n)) \\
&\simeq \mathrm{Hom}_{\mathrm{Ch}^{\bullet}(\mathbf{sVect})}(\mathfrak{g}^*[1] \otimes (\Lambda^q)^*, \Omega_{\mathrm{vert}}^{\bullet}(U \times \Delta^n)) \quad . \\
&\simeq \mathrm{Hom}_{\mathrm{Ch}^{\bullet}(\mathbf{sVect})}((\mathfrak{g} \otimes \Lambda_q)^*[1], \Omega_{\mathrm{vert}}^{\bullet}(\Delta^n)) \\
&\simeq \mathrm{Hom}_{\mathrm{Ch}^{\bullet}(\mathbf{sVect})}((\mathfrak{g} \otimes \Lambda_q)^*[1]_{\mathrm{even}}, \Omega_{\mathrm{vert}}^{\bullet}(U \times \Delta^n)) \\
&\supset \mathrm{Hom}_{\mathrm{dgsAlg}}(\mathrm{CE}((\mathfrak{g} \otimes_k \Lambda_q)_{\mathrm{even}}), \Omega_{\mathrm{vert}}^{\bullet}(U \times \Delta^n))
\end{aligned}$$

Here in the third step we used that the underlying dg-super-algebra of $\mathrm{CE}(\mathfrak{g})$ is free to find the space of morphisms of dg-algebras inside that of super-vector spaces (of generators) as indicated. Since the differential on both sides is Λ_q -linear, the claim follows. \square

5 Applications – Local prequantum higher gauge field theory

We discuss here applications of the general theory of higher differential geometry and of the models developed above to local prequantum higher gauge field theory and string theory [SaSc11a].

- 5.1 – Higher Spin-structures
- 5.2 – Higher prequantum fields
- 5.3 – Higher symplectic geometry
- 5.4 – Higher geometric prequantization
- 5.5 – Higher Chern-Simons field theory
- 5.6 – Higher Wess-Zumino-Witten field theory
- 5.7 – Local boundary and defect prequantum field theory

5.1 Higher Spin-structures

For any $n \in \mathbb{N}$, the Lie group $\text{Spin}(n)$ is the universal simply connected cover of the special orthogonal group $\text{SO}(n)$. Since $\pi_1\text{SO}(n) \simeq \mathbb{Z}_2$, it is an extension of Lie groups of the form

$$\mathbb{Z}_2 \rightarrow \text{Spin}(n) \rightarrow \text{SO}(n).$$

The lift of an $\text{SO}(n)$ -principal bundle through this extension to a $\text{Spin}(n)$ -principal bundle is called a choice of *spin structure*. A classical textbook on the geometry of spin structures is [LaMi89].

We discuss how this construction is only one step in a whole tower of analogous constructions involving smooth n -groups for various n . These are higher smooth analogs of the Spin-group and define higher analogs of smooth spin structures.

The Spin-group carries its name due to the central role that it plays in the description of the physics of quantum *spinning particles*. In 1.1.2 we indicated how the higher spin structures to be discussed here are similarly related to spinning quantum strings and 5-branes. More in detail, this requires *twisted* higher spin structures, which we turn to below in 3.9.8.

- 5.1.1 – Overview: the smooth and differential Whitehead tower of BO
- 5.1.2 – Orientation structure
- 5.1.3 – Spin structure
- 5.1.4 – Smooth string structure and the String-2-group
- 5.1.5 – Smooth fivebrane structure and the Fivebrane-6-group
- 5.1.6 – Higher Spin^c -structures
- 5.1.7 – Spin^c as a homotopy fiber product in $\text{Smooth}\infty\text{Grpd}$
- 5.1.8 – Smooth String^{c^2}

5.1.1 Overview: the smooth and differential Whitehead tower of BO

We survey the constructions and results about the smooth and differential refinement of the Whitehead tower of BO , to be discussed in the following.

By definition 3.8.10 applied in $\infty\text{Grpd} \simeq \text{Top}$, the first stages of the Whitehead tower of the classifying space BO of the orthogonal group, together with the corresponding obstruction classes is constructed by iterated pasting of homotopy pullbacks as in the following diagram:

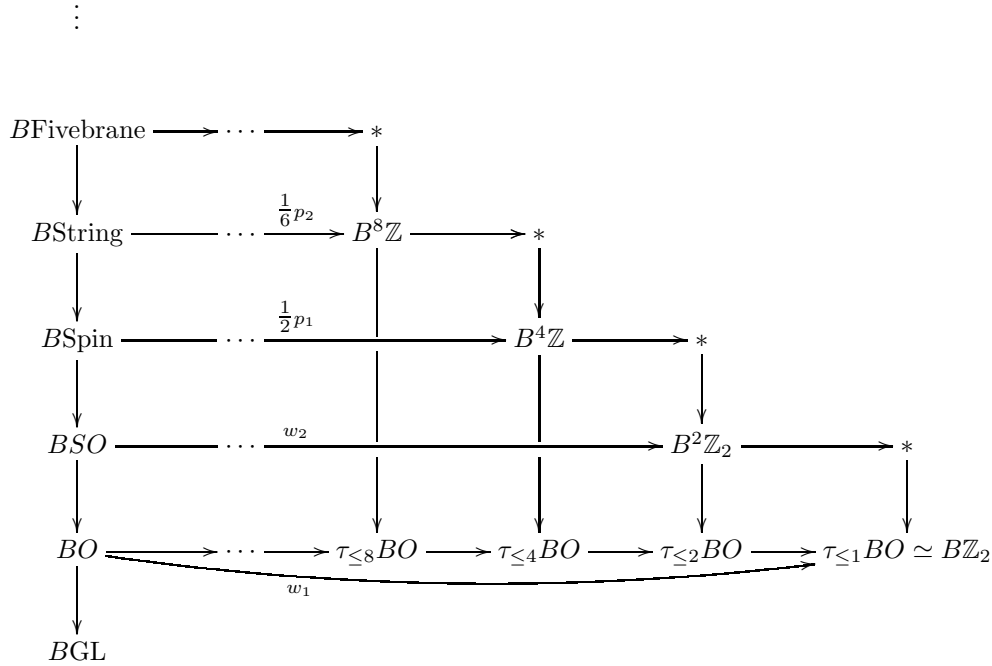

Here the bottom horizontal tower is the Postnikov tower, def. 3.6.25, of BO and all rectangles are homotopy pullbacks.

For X a smooth manifold, there is a canonically given map $X \rightarrow BGL$, which classifies the tangent bundle TX . The lifts of this classifying map through the above Whitehead tower correspond to structures

on X as indicated in the following diagram:

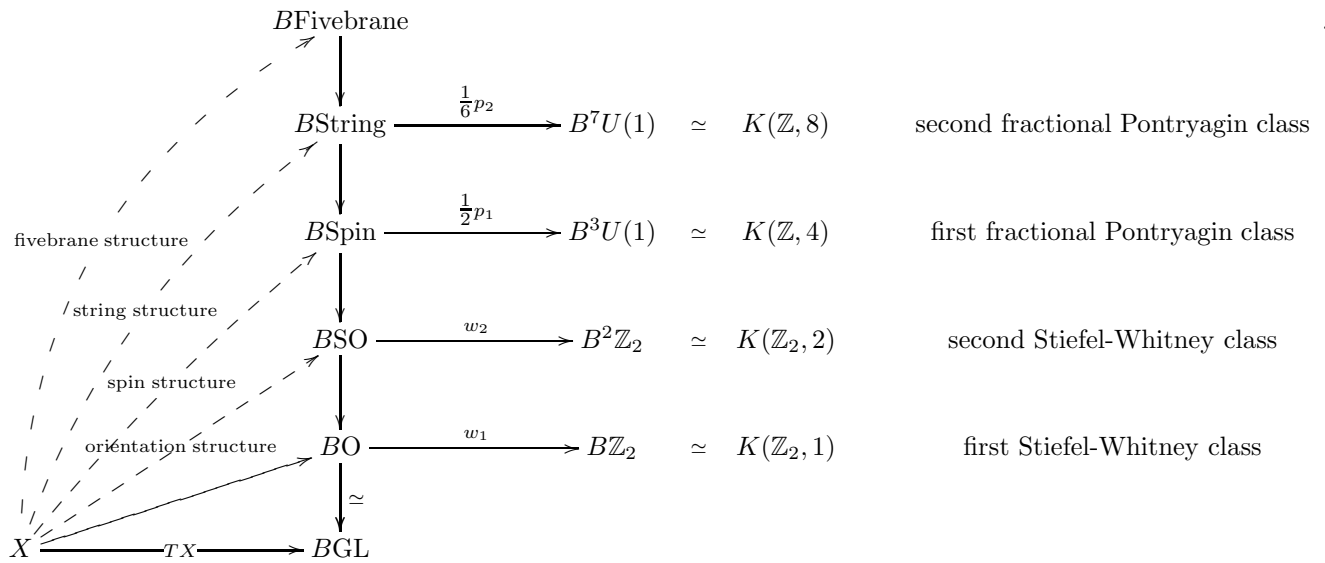

Here the horizontal morphisms denote representatives of universal characteristic classes, such that each sub-diagram of the shape

$$\begin{array}{ccc} B\hat{G} & & \\ \downarrow & & \\ BG & \xrightarrow{c} & B^n K \end{array}$$

is a fiber sequence, def. 3.6.138.

The lifting problem presented by each of these steps is exemplified in terms of a smooth manifold X , which comes with a canonical map $X \rightarrow BGL$ that classifies the tangent bundle TX of X .

In the first step, since the $BO \rightarrow BGL$ is a weak equivalence in $\text{Top} \simeq \infty\text{Grpd}$, we may always factor $X \rightarrow BGL$, up to homotopy, through BO . The homotopy class of the resulting composite $X \rightarrow BO \xrightarrow{w_1} B\mathbb{Z}_2$ is the first Stiefel-Whitney class of the manifold. The fact that BSO is the homotopy fiber of w_1 means, by the universal property of the homotopy pullback, that the further lift to a map $X \rightarrow BSO$ exists precisely if the first Stiefel-Whitney class vanishes. While this is a classical fact, it is useful to make its relation to homotopy pullbacks explicit here, since this illuminates the following steps in this tower as well as all the steps in the smooth and differential refinements to follow.

Next, if the first Stiefel-Whitney class of X vanishes, then any *choice* of orientation, hence any choice of lift $X \rightarrow BSO$ induces the composite map $X \rightarrow BSO \xrightarrow{w_2} B^2\mathbb{Z}_2$, whose homotopy class is the second Stiefel-Whitney class of X equipped with that orientation. If that class vanishes, there exists a choice of lift $X \rightarrow BSpin$, which is a choice of spin structure on X . The resulting composite $X \rightarrow BSpin \xrightarrow{\frac{1}{2}p_1} B^3U(1)$ is a representative of the *first fractional Pontryagin class*. If this vanishes, there exists a choice of lift $X \rightarrow BString$, which equips X with a *string structure*. The induced composite $X \rightarrow BString \xrightarrow{\frac{1}{6}p_2} B^7U(1)$ is a representative of the second fractional Pontryagin class of X . If that vanishes, there exists a choice of lift $X \rightarrow BFivebrane$, which is a choice of *fivebrane structure* on X .

In this or slightly different terminology, this is a classical construction in homotopy theory. We show in the following that this tower has a *smooth lift* from topological spaces through the geometric realization functor, 4.4.4,

$$\text{Smooth}\infty\text{Grpd} \xrightarrow{\Pi} \infty\text{Grpd} \xrightarrow[\simeq]{|-|} \text{Top}$$

to smooth ∞ -groupoids, of the form

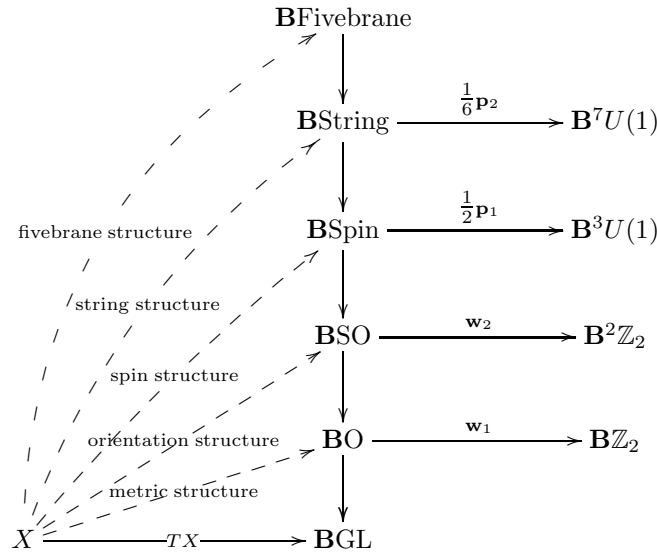

Here $\mathbf{B}^nU(1)$ is the smooth circle $(n + 1)$ -group, def. 4.4.21, the smooth classifying n -stack of smooth circle n -bundles. This is such that still all diagrams of the form

$$\begin{array}{ccc}
 \mathbf{B}\hat{G} & & \\
 \downarrow & & \\
 \mathbf{B}G & \xrightarrow{c} & \mathbf{B}^nK
 \end{array}$$

are fiber sequences, now in the cohesive ∞ -topos $\text{Smooth}\infty\text{Grpd}$, exhibiting the smooth moduli ∞ -stack $\mathbf{B}\hat{G}$ as the homotopy fiber of the smooth universal characteristic map c which is a smooth refinement of the corresponding ordinary characteristic map c .

The corresponding choices of lifts now are more refined than before, as they correspond to *smooth structures*. In the first step, the choice of lift from a morphism $X \rightarrow \mathbf{B}\text{GL}$ to a morphism $X \rightarrow \mathbf{B}\text{SO}$ encodes now genuine information, namely a choice of *Riemannian metric* on X . This is discussed in 5.2.4.1 below.

Further up, a choice of lift $X \rightarrow \mathbf{B}\text{Spin}$ is a choice of smooth Spin-principal bundle on X . Next, the object denoted String is a smooth 2-group, and a lift $X \rightarrow \mathbf{B}\text{String}$ is a choice of smooth String-principal 2-bundle on X . The object denoted Fivebrane is a smooth 6-group and a choice of lift $X \rightarrow \mathbf{B}\text{Fivebrane}$ is a choice of smooth Fivebrane-principal 6-bundle.

One consequence of the smooth refinement, which is important for the *twisted* such structures discussed below in 3.9.8, is that the spaces of choices of lifts are much more refined than those of the ordinary non-smooth case. Another consequence is that it allows us to proceed and next consider a *differential* refinement, def. 3.9.59:

we show that the above smooth Whitehead tower further lifts to a *differential Whitehead tower* of the

form

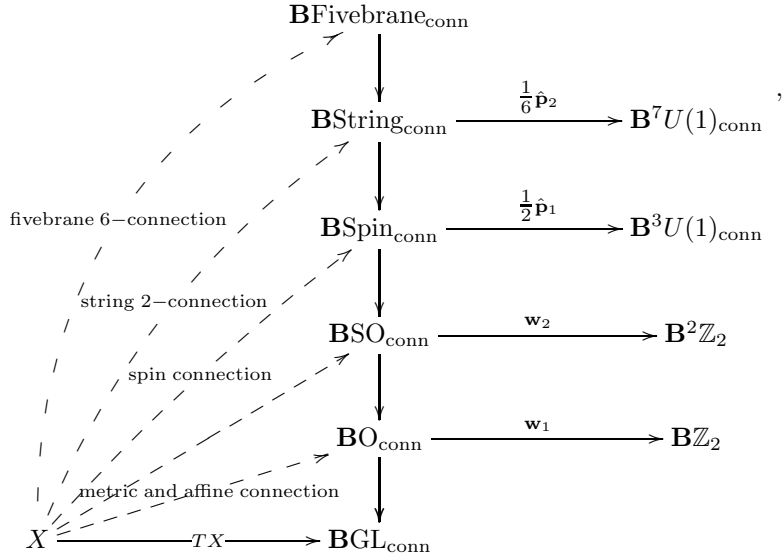

where $\mathbf{B}^n U(1)_{\text{conn}}$ is the moduli n -stack of circle n -bundles with connection, according to 4.4.16. Still, all diagrams of the form

$$\begin{array}{ccc} \mathbf{B}\hat{G}_{\text{conn}} & & \\ \downarrow & & \\ \mathbf{B}G_{\text{conn}} & \xrightarrow{\hat{c}} & \mathbf{B}^n K_{\text{conn}} \end{array}$$

are fiber sequences in $\text{Smooth}\infty\text{Grpd}$, exhibiting the smooth moduli ∞ -stack $\mathbf{B}\hat{G}_{\text{conn}}$, def. 3.9.59, of higher \hat{G} -connections as the homotopy fiber of the differential refinement \hat{c} of the given characteristic map c . Choices of lifts through this tower correspond to choices of smooth higher connections on smooth higher bundles.

5.1.2 Orientation structure

Before going to higher degree beyond the Spin-group, it is instructive to first consider a *lower* degree. The special orthogonal Lie group itself is a kind of extension of the orthogonal Lie group. To see this clearly, consider the smooth delooping $\mathbf{BSO}(n) \in \text{Smooth}\infty\text{Grpd}$ according to 4.4.2.

Proposition 5.1.1. *The canonical morphism $\text{SO}(n) \hookrightarrow \text{O}(n)$ induces a long fiber sequence in $\text{Smooth}\infty\text{Grpd}$ of the form*

$$\mathbb{Z}_2 \rightarrow \mathbf{BSO}(n) \rightarrow \mathbf{BO}(n) \xrightarrow{\mathbf{w}_1} \mathbf{B}\mathbb{Z}_2,$$

where \mathbf{w}_1 is the universal smooth first Stiefel-Whitney class from example 1.2.138.

Proof. It is sufficient to show that the homotopy fiber of \mathbf{w}_1 is $\mathbf{BSO}(n)$. This implies the rest of the statement by prop. 3.6.139.

To see this, notice that by the discussion in 3.6.9 we are to compute the \mathbb{Z}_2 -principal bundle over the Lie groupoid $\mathbf{BSO}(n)$ that is classified by the above injection. By observation 3.6.179 this is accomplished by forming a 1-categorical pullback of Lie groupoids

$$\begin{array}{ccc} \mathbb{Z}_2 // \text{O}(n) & \longrightarrow & \mathbb{Z}_2 // \mathbb{Z}_2 \\ \downarrow & & \downarrow \\ * // \text{O}(n) & \longrightarrow & * // \mathbb{Z}_2 \end{array}$$

One sees that the canonical projection

$$\mathbb{Z}_2 // \mathbf{O}(n) \xrightarrow{\cong} * // \mathbf{SO}(n)$$

is a weak equivalence (it is an essentially surjective and full and faithful functor of groupoids). \square

Definition 5.1.2. For $X \in \text{Smooth}\infty\text{Grpd}$ any object equipped with a morphism $r_X : X \rightarrow \mathbf{BO}(n)$, we say a lift o_X of r through the above extension

$$\begin{array}{ccc} & & \mathbf{BSO}(n) \\ & \nearrow^{o_X} & \downarrow \\ X & \xrightarrow{r} & \mathbf{BO}(n) \end{array}$$

is an *orientation structure* on (X, r_X) .

5.1.3 Spin structure

Proposition 5.1.3. *The classical sequence of Lie groups $\mathbb{Z}_2 \rightarrow \text{Spin} \rightarrow \text{SO}$ induces a long fiber sequence in $\text{Smooth}\infty\text{Grpd}$ of the form*

$$\mathbb{Z}_2 \rightarrow \text{Spin} \rightarrow \text{SO} \rightarrow \mathbf{B}\mathbb{Z}_2 \rightarrow \mathbf{B}\text{Spin} \rightarrow \mathbf{BSO} \xrightarrow{\mathbf{w}_2} \mathbf{B}^2\mathbb{Z}_2,$$

where \mathbf{w}_2 is the universal smooth second Stiefel-Whitney class from example 1.2.139.

Proof. It is sufficient to show that the homotopy fiber of \mathbf{w}_2 is $\mathbf{B}\text{Spin}(n)$. This implies the rest of the statement by prop. 3.6.139.

To see this notice that the top morphism in the stanard anafunctor that presents \mathbf{w}_2

$$\begin{array}{ccc} \mathbf{B}(\mathbb{Z}_2 \rightarrow \mathbf{O}(n))_{\text{ch}} & \longrightarrow & \mathbf{B}(\mathbb{Z}_2 \rightarrow 1)_{\text{ch}} & \mathbf{B}^2\mathbb{Z}_2 \\ \downarrow \simeq & & & \\ \mathbf{BSO}(n) & & & \end{array}$$

is a fibration in $[\text{CartSp}^{\text{op}}, \text{sSet}]_{\text{proj}}$. By proposition 2.3.13 this means that the homotopy fiber is given by the 1-categorical pullback of simplicial presheaves

$$\begin{array}{ccc} \mathbf{B}(\mathbb{Z}_2 \rightarrow \mathbf{O}(n))_{\text{ch}} & \longrightarrow & * \\ \downarrow & & \downarrow \\ \mathbf{B}(\mathbb{Z}_2 \rightarrow \mathbf{O}(n))_{\text{ch}} & \xrightarrow{\mathbf{w}_2} & \mathbf{B}(\mathbb{Z}_2 \rightarrow 1)_{\text{ch}} \end{array} .$$

The canonical projection

$$\mathbf{B}(\mathbb{Z}_2 \rightarrow \mathbf{O}(n))_{\text{ch}} \xrightarrow{\cong} \mathbf{BSO}(n)_{\text{ch}}$$

is seen to be a weak equivalence. \square

Definition 5.1.4. For $X \in \text{Smooth}\infty\text{Grpd}$ an object equipped with orientation structure $o_X : X \rightarrow \mathbf{BSO}(n)$, def. 5.1.2, we say a choice of lift \hat{o}_X in

$$\begin{array}{ccc} & & \mathbf{B}\text{Spin} \\ & \nearrow^{\hat{o}_X} & \downarrow \\ X & \xrightarrow{o_X} & \mathbf{BSO}(n) \end{array}$$

equips (X, o_X) with *spin structure*.

5.1.4 Smooth string structure and the String-2-group

The sequence of Lie groupoids

$$\cdots \rightarrow \mathbf{BSpin}(n) \rightarrow \mathbf{BSO}(n) \rightarrow \mathbf{BO}(n)$$

discussed in 5.1.2 and 5.1.3 is a smooth refinement of the first two steps of the *Whitehead tower* of $BO(n)$. We discuss now the next step. This is no longer presented by Lie groupoids, but by smooth 2-groupoids.

Write $\mathfrak{so}(n)$ for the special orthogonal Lie algebra in dimension n . We shall in the following notationally suppress the dimension and just write \mathfrak{so} . The simply connected Lie group integrating \mathfrak{so} is the Spin-group .

Proposition 5.1.5. *Pulled back to $B\mathbf{Spin}$ the universal first Pontryagin class $p_1 : BO \rightarrow B^4\mathbb{Z}$ is 2 times a generator $\frac{1}{2}p_1$ of $H^4(B\mathbf{Spin}, \mathbb{Z})$*

$$\begin{array}{ccc} B\mathbf{Spin} & \xrightarrow{\frac{1}{2}p_1} & B^4\mathbb{Z} . \\ \downarrow & & \downarrow \cdot 2 \\ BO & \xrightarrow{p_1} & B^4\mathbb{Z} \end{array}$$

We call $\frac{1}{2}p_1$ the first fractional Pontryagin class .

This is due to [Bott58]. See [SSS09b] for a review.

Definition 5.1.6. Write $B\mathbf{String}$ for the homotopy fiber in $\mathbf{Top} \simeq \infty\mathbf{Grpd}$ of the first fractional Pontryagin class

$$\begin{array}{ccc} B\mathbf{String} & \longrightarrow & * . \\ \downarrow & & \downarrow \\ B\mathbf{Spin} & \xrightarrow{\frac{1}{2}p_1} & B^4\mathbb{Z} \end{array}$$

Its loop space is the *string group*

$$\mathbf{String} := O\langle 7 \rangle := \Omega B\mathbf{String} .$$

This is defined up to equivalence as an ∞ -group object, but standard methods give a presentation by a genuine topological group and often the term *string group* is implicitly reserved for such a topological group model. See also the review in [Scho10].

We now discuss smooth refinements of $\frac{1}{2}p_1$ and of \mathbf{String} as lifts through the intrinsic geometric realization, def. 3.8.2, $\Pi : \mathbf{Smooth}\infty\mathbf{Grpd} \rightarrow \infty\mathbf{Grpd}$ in $\mathbf{Smooth}\infty\mathbf{Grpd}$, 4.4.

Proposition 5.1.7. *We have a weak equivalence*

$$\mathbf{cosk}_3(\exp(\mathfrak{so})) \xrightarrow{\simeq} \mathbf{BSpin}_c$$

in $[\mathbf{CartSp}_{\mathbf{smooth}}^{\text{op}}, \mathbf{sSet}]_{\text{proj}}$, between the Lie integration, 4.4.14, of \mathfrak{so} and the standard presentation, 4.4.2, of \mathbf{BSpin} .

Proof. By prop. 4.4.60. □

Corollary 5.1.8. *The image of $\mathbf{BSpin} \in \mathbf{Smooth}\infty\mathbf{Grpd}$ under the fundamental ∞ -groupoid/geometric realization functor Π , 4.3.4, is the classifying space $B\mathbf{Spin}$ of the topological Spin-group*

$$|\Pi\mathbf{BSpin}| \simeq B\mathbf{Spin} .$$

Proof. By prop. 4.3.30 applied to prop. 4.4.19. □

Theorem 5.1.9. *The image under Lie integration, 4.4.14, of the canonical Lie algebra 3-cocycle*

$$\mu = \langle -, [-, -] \rangle : \mathfrak{so} \rightarrow b^2\mathbb{R}$$

on the semisimple Lie algebra \mathfrak{so} of the Spin group is a morphism in $\text{Smooth}\infty\text{Grpd}$ of the form

$$\frac{1}{2}\mathbf{p}_1 := \exp(\mu) : \mathbf{B}\text{Spin} \rightarrow \mathbf{B}^3U(1)$$

whose image under the fundamental ∞ -groupoid ∞ -functor/ geometric realization, 4.3.4, $\Pi : \text{Smooth}\infty\text{Grpd} \rightarrow \infty\text{Grpd}$ is the ordinary fractional Pontryagin class $\frac{1}{2}p_1 : B\text{Spin} \rightarrow B^4\mathbb{Z}$ in Top , and up to equivalence $\exp(\mu)$ is the unique lift of $\frac{1}{2}p_1$ from Top to $\text{Smooth}\infty\text{Grpd}$ with codomain $\mathbf{B}^3U(1)$. We write $\frac{1}{2}\mathbf{p}_1 := \exp(\mu)$ and call it the smooth first fractional Pontryagin class.

Moreover, the corresponding refined differential characteristic class, 4.4.17,

$$\frac{1}{2}\hat{\mathbf{p}}_1 : \mathbf{H}_{\text{conn}}(-, \mathbf{B}\text{Spin}) \rightarrow \mathbf{H}_{\text{diff}}(-, \mathbf{B}^3U(1)),$$

which we call the fractional Pontryagin class, is in cohomology the corresponding ordinary refined Chern-Weil homomorphism [HoSi05]

$$[\frac{1}{2}\hat{\mathbf{p}}_1] : H_{\text{Smooth}}^1(X, \text{Spin}) \rightarrow H_{\text{diff}}^4(X)$$

with values in ordinary differential cohomology that corresponds to the Killing form invariant polynomial $\langle -, - \rangle$ on \mathfrak{so} .

Proof. This is shown in [FSS10].

Using corollary. 5.1.7 and unwinding all the definitions and using the characterization of smooth de Rham coefficient objects, 4.4.13, and smooth differential coefficient objects, 4.4.16, one finds that the post-composition with $\exp(\mu, \text{cs})_{\text{diff}}$ induces on Čech cocycles precisely the operation considered in [BrMc96b], and hence the conclusion follows essentially as by the reasoning there: one reads off the 4-curvature of the circle 3-bundle assigned to a Spin bundle with connection ∇ to be $\propto \langle F_{\nabla} \wedge F_{\nabla} \rangle$, with the normalization such that this is the image in de Rham cohomology of the generator of $H^4(B\text{Spin}) \simeq \mathbb{Z} \simeq \langle \frac{1}{2}p_1 \rangle$.

Finally that $\frac{1}{2}\mathbf{p}_1$ is the unique smooth lift of $\frac{1}{2}p_1$ follows from theorem 4.4.36. \square

By the unique smooth refinement of the first fractional Pontryagin class, 5.1.9, we obtain a smooth refinement of the String-group, def. 5.1.6.

Definition 5.1.10. Write $\mathbf{B}\text{String}$ for the homotopy fiber in $\text{Smooth}\infty\text{Grpd}$ of the smooth refinement of the first fractional Pontryagin class from prop. 5.1.9:

$$\begin{array}{ccc} \mathbf{B}\text{String} & \longrightarrow & * \\ \downarrow & & \downarrow \\ \mathbf{B}\text{Spin} & \xrightarrow{\frac{1}{2}\mathbf{p}_1} & \mathbf{B}^3U(1) \end{array} .$$

We say its loop space object is the *smooth string 2-group*

$$\text{String}_{\text{smooth}} := \Omega\mathbf{B}\text{String} .$$

We speak of a smooth 2-group because $\text{String}_{\text{smooth}}$ is a categorical homotopy 1-type in $\text{Smooth}\infty\text{Grpd}$, being an extension

$$\mathbf{B}U(1) \rightarrow \text{String}_{\text{smooth}} \rightarrow \text{Spin}$$

of the categorical 0-type Spin by the categorical 1-type $\mathbf{B}U(1)$ in $\text{Smooth}\infty\text{Grp}$.

Proposition 5.1.11. *The categorical homotopy groups of the smooth String 2-group, $\pi_n(\mathbf{BString}) \in \text{Sh}(\text{CartSp})$, are*

$$\pi_1(\mathbf{BString}) \simeq \text{Spin}$$

and

$$\pi_2(\mathbf{BString}) \simeq U(1).$$

All other categorical homotopy groups are trivial.

Proof. Notice that by construction the non-trivial categorical homotopy groups of \mathbf{BSpin} and $\mathbf{B}^3U(1)$ are $\pi_1\mathbf{BSpin} = \text{Spin}$ and $\pi_3\mathbf{B}^3U(1) = U(1)$, respectively. Using the long exact sequence of homotopy sheaves (use [L-Topos] remark 6.5.1.5, with $X = *$ the base point) applied to def. 5.1.10, we obtain the long exact sequence of pointed objects in $\text{Sh}(\text{CartSp})$

$$\cdots \rightarrow \pi_{n+1}(\mathbf{B}^3U(1)) \rightarrow \pi_n(\mathbf{BString}) \rightarrow \pi_n(\mathbf{BSpin}) \rightarrow \pi_n(\mathbf{B}^3U(1)) \rightarrow \pi_{n-1}(\mathbf{BString}) \rightarrow \cdots$$

this yields for $n = 0$

$$0 \rightarrow \pi_1(\mathbf{BString}) \rightarrow \text{Spin} \rightarrow 0$$

and for $n = 2$

$$0 \rightarrow U(1) \rightarrow \pi_2(\mathbf{BString}) \rightarrow 0$$

and for $n \geq 3$

$$0 \rightarrow \pi_n(\mathbf{BString}) \rightarrow 0.$$

□

However the *geometric* homotopy type, 3.8.1, of $\mathbf{BString}$ is not bounded, in fact it coincides with that of the topological string group:

Proposition 5.1.12. *Under intrinsic geometric realization, 4.4.4, $|-| : \text{Smooth}\infty\text{Grpd} \xrightarrow{\Pi} \infty\text{Grp} \xrightarrow{|_|} \text{Top}$ the smooth string 2-group maps to the topological string group*

$$|\text{String}_{\text{smooth}}| \simeq \text{String}.$$

Proof. Since $\mathbf{B}^3U(1)$ has a presentation by a simplicial object in SmoothMfd , prop. 4.4.29 asserts that

$$|\text{String}_{\text{smooth}}| \simeq \text{hofib}\left|\frac{1}{2}\mathbf{p}_1\right|.$$

The claim then follows with prop. 5.1.9

$$\cdots \simeq \text{hofib}\frac{1}{2}p_1$$

and def. 5.1.6

$$\cdots \simeq \text{String}.$$

□

Notice the following important subtlety:

Proposition 5.1.13. *There exists an infinite-dimensional Lie group $\text{String}_{1\text{smooth}}$ whose underlying topological group is a model for the String group in Top , def. 5.1.6.*

This is due to [NSW11], by a refinement of a construction in [Stol96].

Remark 5.1.14. However, $\mathbf{BString}_{1\text{smooth}}$ itself is not a model for def. 5.1.10, because it is an internal 1-type in $\text{Smooth}\infty\text{Grpd}$, hence because $\pi_2\mathbf{BString}_{1\text{smooth}} = 0$. In [NSW11] a smooth 2-group with the correct internal homotopy groups based on $\text{String}_{1\text{smooth}}$ is given, but it is not clear yet whether or not this is a model for def. 5.1.10.

We proceed by discussing concrete presentations of the smooth string 2-group.

Definition 5.1.15. Write

$$\mathbf{string} := \mathfrak{so}_\mu$$

for the L_∞ -algebra extension of \mathfrak{so} induced by μ according to def 4.4.105.

We call this the *string Lie 2-algebra*

Observation 5.1.16. The indecomposable invariant polynomials on \mathbf{string} are those of \mathfrak{so} except for the Killing form:

$$\text{inv}(\mathbf{string}) = \text{inv}(\mathfrak{so}) / (\langle -, - \rangle).$$

Proof. As a special case of prop. 4.4.123. □

Proposition 5.1.17. *The smooth ∞ -groupoid that is the Lie integration of \mathfrak{so}_μ is a model for the smooth string 2-group*

$$\mathbf{BString} \simeq \mathbf{cosk}_3 \exp(\mathfrak{so}_\mu).$$

Notice that this statement is similar to, but different from, the statement about the untruncated exponentiated L_∞ -algebras in prop. 4.4.111.

Proof. By prop. 5.1.9 an explicit presentation for $\mathbf{BString}$ is given by the pullback

$$\begin{array}{ccc} \mathbf{BString}_c & \longrightarrow & \mathbf{EB}^2U(1)_c \\ \downarrow & & \downarrow \\ \mathbf{cosk}_3 \exp(\mathfrak{so}) & \xrightarrow{f_{\Delta^\bullet} \cdot \exp(\mu)} & \mathbf{B}^3U(1)_c \end{array}$$

in $[\text{CartSp}^{\text{op}}, \text{sSet}]$, where $\mathbf{B}^3U(1)_c$ is the simplicial presheaf whose 3-cells form the space $U(1)$, and where $\mathbf{EB}^2U(1)$ is the simplicial presheaf whose 2-cells form $U(1)$ and whose 3-cells form the space of arbitrary quadruples of elements in $U(1)$. The right vertical morphism forms the oriented sum of these quadruples.

Since all objects are 3-truncated, it is sufficient to consider the pullback of the simplices in degrees 0 to 3. In degrees 0 to 1 the morphism $\mathbf{EB}^2U(1) \rightarrow \mathbf{B}^3U(1)_c$ is the identity, hence in these degrees $\mathbf{BString}_c$ coincides with $\mathbf{cosk}_3 \exp(\mathfrak{so})$. In degree 2 the pullback is the product of $\mathbf{cosk}_3(\mathfrak{so})_2$ with $U(1)$, hence the 2-cells of $\mathbf{BString}_c$ are pairs (f, c) consisting of a smooth map $f : \Delta^2 \rightarrow \text{Spin}$ (with sitting instants) and an element $c \in U(1)$. Finally a 3-cell in $\mathbf{BString}_c$ is a pair $(\sigma, \{c_i\})$ of a smooth map $\sigma : \Delta^3 \rightarrow \text{Spin}$ and four labels $c_i \in U(1)$, subject to the condition that the sum of the labels is the integral of the cocycle μ over σ :

$$c_4 c_2 c_1^{-1} c_3^{-1} = \int_{\Delta^3} \sigma^* \mu(\theta) \text{ mod } \mathbb{Z},$$

(with θ the Maurer-Cartan form on Spin).

The description of the cells in $\mathbf{cosk}_3 \exp(\mathfrak{g}_\mu)$ is similar: a 2-cells is a pair (f, B) consisting of a smooth function $f : \Delta^2 \rightarrow \text{Spin}$ and a smooth 2-form $B \in \Omega^2(\Delta^2)$ (both with sitting instants), and a 3-cell is a pair consisting of a smooth function $\sigma : \Delta^3 \rightarrow \text{Spin}$ and a 2-form $\hat{B} \in \Omega^2(\Delta^3)$ such that $d\hat{B} = \sigma^* \mu(\theta)$.

There is an evident morphism

$$p : \int_{\Delta^\bullet} : \mathbf{cosk}_3(\mathfrak{so}_\mu) \rightarrow \mathbf{BString}_c$$

that is the identity on the smooth maps from simplices into the Spin -group and which sends the 2-form labels to their integral over the 2-faces

$$p_2 : (f, B) \mapsto (f, (\int_{\Delta^2} B) \text{ mod } \mathbb{Z}).$$

We claim that this is a weak equivalence. The first simplicial homotopy group on both sides is Spin itself (meaning: the presheaf on CartSp represented by Spin). The nontrivial simplicial homotopy group to check is the second. Since $\pi_2(\text{Spin}) = 0$ every pair (f, B) on $\partial\Delta^3$ is homotopic to one where f is constant. It follows from prop. 4.4.64 that the homotopy classes of such pairs where also the homotopy involves a constant map $\partial\Delta^3 \times \Delta^1 \rightarrow \text{Spin}$ are given by \mathbb{R} , being the integral of the 2-forms. But then moreover there are the non-constant homotopies in Spin from the constant 2-sphere to itself. Since $\pi_3(\text{Spin}) = \mathbb{Z}$ and $\mu(\theta)$ is an integral form, this reduces the homotopy classes to $U(1) = \mathbb{R}/\mathbb{Z}$. This are the same as in $\mathbf{BString}_c$ and the integration map that sends the 2-forms to elements in $U(1)$ is an isomorphism on these homotopy classes. \square

Remark 5.1.18. Propositions 5.1.17 and 5.1.12 together imply that the geometric realization $|\mathbf{cosk}_3 \exp(\mathfrak{so}_\mu)|$ is a model for $B\text{String}$ in Top

$$|\exp(\mathfrak{so}_\mu)| \simeq B\text{String}.$$

With slight differences in the technical realization of $\exp(\mathfrak{g}_m u)$ this was originally shown in [Hen08], theorem 8.4. For the following discussion however the above perspective, realizing $\mathbf{cosk}_3 \exp(\mathfrak{so}_\mu)$ as a presentation of the homotopy fiber of the smooth first fractional Pontryagin class, def 5.1.10, is crucial.

We now discuss three equivalent but different models of the smooth String 2-group by diffeological *strict* 2-groups, hence by crossed modules of diffeological groups. See [BCSS07] for the general notion of strict Fréchet-Lie 2-groups and for discussion of one of the following models.

Definition 5.1.19. For $(G_1 \rightarrow G_0)$ a crossed module of diffeological groups (groups of concrete sheaves on CartSp) write

$$\Xi(G_1 \rightarrow G_0) \in [\text{CartSp}^{\text{op}}, \text{sSet}]$$

for the corresponding presheaf of simplicial groups.

There is an evident strictification of $\mathbf{BString}_c$ from the proof of prop 5.1.17 given by the following definition. For the notion of thin homotopy classes of paths and disks see [ScWa08].

Definition 5.1.20. Write

$$\hat{\Omega}_{\text{thSpin}} \rightarrow P_{\text{thSpin}},$$

for the crossed module where

- P_{thSpin} is the group whose elements are *thin-homotopy* classes of based smooth paths in G and whose product is obtained by rigidly translating one path so that its basepoint matches the other path's endpoint and then concatenating;
- $\hat{\Omega}_{\text{thSpin}}$ is the group whose elements are equivalence classes of pairs (d, x) consisting of *thin homotopy* classes of disks $d : D^2 \rightarrow G$ in G with sitting instant at a chosen point on the boundary, together with an element $x \in \mathbb{R}/\mathbb{Z}$. Two such pairs are taken to be equivalent if the boundary of the disks has the same thin homotopy classes and if the labels x and x' differ, in \mathbb{R}/\mathbb{Z} , by the integral $\int_{D^3} f^* \mu(\theta)$ over any 3-ball $f : D^3 \rightarrow G$ cobounding the two disks. The product is given by translating and then *gluing* of disks at their basepoint (so that their boundary paths are being concatenated, hence multiplied in P_{thSpin}) and adding the labels in \mathbb{R}/\mathbb{Z} .

The map from $\hat{\Omega}_{\text{thSpin}}$ to P_{thSpin} is given by sending a disk to its boundary path.

The action of P_{thSpin} on $\hat{\Omega}_{\text{thSpin}}$ is given by whiskering a disk by a path and its reverse path.

Proposition 5.1.21. *Let*

$$\mathbf{BString}_c \rightarrow \mathbf{B}\Xi(\hat{\Omega}_{\text{thSpin}} \rightarrow P_{\text{thSpin}})$$

be the morphism that sends maps to Spin to their thin-homotopy class. This is a weak equivalence in $[\text{CartSp}^{\text{op}}, \text{sSet}]_{\text{proj}}$.

We produce now two equivalent crossed modules that are both obtained as central extensions of path groups. This is joint with Danny Stevenson, based on results in [MuSt03].

The following proposition is standard.

Proposition 5.1.22. *Let $H \subset G$ be a normal subgroup of some group G and let $\hat{H} \rightarrow H$ be a central extension of groups such that the conjugation action of G on H lifts to an automorphism action $\alpha : G \rightarrow \text{Aut}(\hat{H})$ on the central extension. Then $(\hat{H} \rightarrow G)$ with this α is a crossed module.*

We construct classes of examples of this type from central extensions of path groups.

Proposition 5.1.23. *Let $G \subset \Gamma$ be a simply connected normal Lie subgroup of a Lie group Γ . Write PG for the based path group of G whose elements are smooth maps $[0, 1] \rightarrow G$ starting at the neutral element and whose product is given by the pointwise product in G . Consider the complex with differential $d \pm \delta$ of simplicial forms on \mathbf{BG}_{ch} . Let (F, a, β) be a triple where*

- i. $a \in \Omega^1(G \times G)$ such that $\delta a = 0$;*
- ii. F is a closed integral 2-form on G such that $\delta F = da$;*
- iii. $\beta : \Gamma \rightarrow \Omega^1(G)$ such that, for all $\gamma, \gamma_1, \gamma_2 \in \Gamma$,*

- $\gamma^* F = F + d\beta_\gamma$;
- $(\gamma_1)^* \beta_{\gamma_2} - \beta_{\gamma_1 \gamma_2} + \beta_{\gamma_1} = 0$;
- $a = \gamma^* a + \delta(\beta_\gamma)$;
- for all based paths $f : [0, 1] \rightarrow G$, $f^* \beta_\gamma = (f, \gamma^{-1})^* a + (\gamma, f\gamma^{-1})^* a$.

1. Then the map $c : PG \times PG \rightarrow U(1)$ given by $c : (f, g) \mapsto c_{f,g} := \exp\left(2\pi i \int_{0,1} (f, g)^* a\right)$ is a group 2-cocycle

leading to a central extension $\hat{P}G = PG \times U(1)$ with product $(\gamma_1, x_1) \cdot (\gamma_2, x_2) = (\gamma_1 \cdot \gamma_2, x_1 x_2 c_{\gamma_1, \gamma_2})$.

2. Since G is simply connected every loop in G bounds a disk D . There is a normal subgroup $N \subset \hat{P}G$ consisting of pairs (γ, x) with $\gamma(1) = e$ and $x = \exp(2\pi i \int_D F)$ for any disk D in G such that $\partial D = \gamma$.

3. Finally, $\tilde{G} := \hat{P}G/N$ is a central extension of G by $U(1)$ and the conjugation action of Γ on G lifts to \tilde{G} by setting $\alpha(\gamma)(f, x) := (\alpha(\gamma)(f), x \exp(\int_f \beta_\gamma))$ such that $\text{Cent}(G, \Gamma, F, a, \beta) := (\tilde{G} \rightarrow \Gamma)$ is a Lie crossed module and hence a strict Lie 2-group of the type in prop. 5.1.22.

Proof. All statements about the central extension \tilde{G} can be found in [MuSt03]. It remains to check that the action $\alpha : \Gamma \rightarrow \text{Aut}(\tilde{G})$ satisfies the required axioms of a crossed module, in particular the condition $\alpha(t(h))(h') = hh'h^{-1}$. For this we have to show that

$$\alpha(h(1))([f, z]) = [h, 1][f, z] \left[h^{-1}, \exp\left(-\int_{(h, h^{-1})} a\right) \right],$$

where h denotes a based path in PG , so that $[h, 1]$ represents an element of \tilde{G} . By definition of the product in \tilde{G} , the right hand side is equal to

$$\left[hfh^{-1}, z \exp\left(\int_{(h, f)} a + \int_{(hf, h^{-1})} a - \int_{(h, h^{-1})} a\right) \right].$$

This is not exactly in the form we want, since the left hand side is equal to $[h(1)fh(1)^{-1}, z \exp(\int_f \beta_h)]$. Therefore, we want to replace hfh^{-1} with the homotopic path $h(1)fh(1)^{-1}$. An explicit homotopy between

these two paths is given by $H(s, t) = h((1-s)t + s)f(t)h((1-s)t + s)^{-1}$. Therefore, we have the equality

$$\begin{aligned} & \left[hfh^{-1}, z \exp \left(\int_{(h,f)} a + \int_{(hf,h^{-1})} a - \int_{(h,h^{-1})} a \right) \right] \\ &= \left[h(1)fh(1)^{-1}, z \exp \left(\int_{(h,f)} a + \int_{(hf,h^{-1})} a - \int_{(h,h^{-1})} a + \int H^*F \right) \right]. \end{aligned}$$

Using the relation $\delta(F) = da$ and the fact that the pullback of F along the maps $[0, 1] \times [0, 1] \rightarrow G$, $(s, t) \mapsto h((1-s)t + s)$ vanish, we see that

$$\int H^*F = \int_{(f,h(1)^{-1})} a - \int_{(f,h^{-1})} a + \int_{(h,h^{-1})} a + \int_{(h(1),fh(1)^{-1})} a - \int_{(h,fh^{-1})} a.$$

Therefore the sum of integrals

$$\int_{(h,f)} a + \int_{(hf,h^{-1})} a - \int_{(h,h^{-1})} a + \int H^*F$$

can be written as

$$\int_{(h,f)} a + \int_{(hf,h^{-1})} a - \int_{(h,h^{-1})} a + \int_{(f,h(1)^{-1})} a - \int_{(f,h^{-1})} a + \int_{(h,h^{-1})} a + \int_{(h(1),fh(1)^{-1})} a - \int_{(h,fh^{-1})} a.$$

Using the condition $\delta(a) = 0$, we see that this simplifies down to $\int_{(f,h(1)^{-1})} a + \int_{(h(1),fh(1)^{-1})} a$. Therefore, a sufficient condition to have a crossed module is the equation $f^*\beta_h = (f, h(1))^*a + (h(1), fh(1)^{-1})^*a$. \square

Proposition 5.1.24. *Given triples (F, a, β) and (F', a', β') as above and given $b \in \Omega^1(G)$ such that*

$$F' = F + db, \tag{5.1}$$

$$a' = a + \delta(b) \tag{5.2}$$

and for all $\gamma \in \Gamma$

$$\beta_\gamma + \gamma^*b = b + \beta'_\gamma, \tag{5.3}$$

then there is an isomorphism $\text{Cent}(G, \Gamma, F, a, \beta) \simeq \text{Cent}(G, \Gamma, F', a', \beta')$.

In [BCSS07] the following special case of this general construction was considered.

Definition 5.1.25. Let G be a compact, simple and simply-connected Lie group with Lie algebra \mathfrak{g} . Let $\langle \cdot, \cdot \rangle$ be the Killing form invariant polynomial on \mathfrak{g} , normalized such that the Lie algebra 3-cocycle $\mu := \langle \cdot, [\cdot, \cdot] \rangle$ extends left invariantly to a 3-form on G which is the image in deRham cohomology of one of the two generators of $H^3(G, \mathbb{Z}) = \mathbb{Z}$. Let ΩG be the based loop group of G whose elements are smooth maps $\gamma : [0, 1] \rightarrow G$ with $\gamma(0) = \gamma(1) = e$ and whose product is by pointwise multiplication of such maps. Define $F \in \Omega^2(\Omega G)$, $a \in \Omega^1(\Omega G \times \Omega G)$ and $\beta : \Gamma \rightarrow \Omega^1(\Omega G)$

$$\begin{aligned} F(\gamma, X, Y) &:= \int_0^{2\pi} \langle X, Y' \rangle dt \\ a(\gamma_1, \gamma_2, X_1, X_2) &:= \int_0^{2\pi} \langle X_1, \dot{\gamma}_2 \gamma_2^{-1} \rangle dt \\ \beta(p)(\gamma, X) &:= \int_0^{2\pi} \langle p^{-1} \dot{p}, X \rangle dt \end{aligned}$$

This satisfies the axioms of prop. 5.1.23 and we write

$$\text{String}_{\text{BCSS}}(G) := \Xi \text{Cent}(\Omega G, PG, F, \alpha, \beta)$$

for the corresponding diffeological strict 2-group. If $G = \text{Spin}$ we write just $\text{String}_{\text{BCS}}$ for this.

There is a variant of this example, using another cocycle on loop groups that was given in [Mic87].

Definition 5.1.26. With all assumptions as in definition 5.1.25 define now

$$\begin{aligned} F(\gamma, X, Y) &:= \frac{1}{2} \int_0^{2\pi} \langle \gamma^{-1} \dot{\gamma}, [X, Y] \rangle dt \\ a(\gamma_1, \gamma_2, X_1, X_2) &:= \frac{1}{2} \int_0^{2\pi} (\langle X_1, \dot{\gamma}_2 \gamma_2^{-1} \rangle - \langle \gamma_1^{-1} \dot{\gamma}_1, \gamma_2 X_2 \gamma_2^{-1} \rangle) dt \\ \beta(p)(\gamma, X) &:= \frac{1}{2} \int_0^{2\pi} \langle \gamma^{-1} p^{-1} \dot{p} \gamma + p^{-1} \dot{p}, X \rangle dt \end{aligned}$$

This satisfies the axioms of proposition 5.1.23 and we write

$$\text{String}_{\text{Mick}}(G) := \Xi \text{Cent}(\Omega G, PG, F, \alpha, \beta)$$

for the corresponding 2-group. If $G = \text{Spin}$ we write just $\text{String}_{\text{Mick}}$ for this.

Proposition 5.1.27. *There is an isomorphism of 2-groups $\text{String}_{\text{BCSS}}(G) \xrightarrow{\cong} \text{String}_{\text{Mick}}(G)$.*

Proof. We show that $b \in \Omega^1(\Omega G)$ defined by $b(\gamma, X) := \frac{1}{4\pi} \int_0^{2\pi} \langle \gamma^{-1} \dot{\gamma}, X \rangle dt$ satisfies the conditions of prop. 5.1.24 and hence defines the desired isomorphism.

- Proof of equation 5.1: We calculate the exterior derivative db . To do this we first calculate the derivative $Xb(y)$: if $\gamma_t = \gamma e^{tX}$ then to first order in t , $\gamma_t^{-1} \dot{\gamma}_t$ is equal to $\gamma^{-1} \dot{\gamma} + t[\gamma^{-1} \dot{\gamma}, X] + tX'$. Therefore

$$Xb(Y) = \frac{1}{2} \int_0^{2\pi} (\langle \gamma^{-1} \dot{\gamma}, [X, Y] \rangle + \langle X', Y \rangle) dt .$$

Hence db is equal to

$$\frac{1}{2} \int_0^{2\pi} (\langle \gamma^{-1} \dot{\gamma}, [X, Y] \rangle + \langle X', Y \rangle + \langle \gamma^{-1} \dot{\gamma}, [X, Y] \rangle - \langle Y', X \rangle - \langle \gamma^{-1} \dot{\gamma}, [X, Y] \rangle) ,$$

which is easily seen to simplify down to

$$- \int_0^{2\pi} \langle X, Y \rangle dt + \frac{1}{2} \int_0^{2\pi} \langle \gamma^{-1} \dot{\gamma}, [X, Y] \rangle dt .$$

- Proof of equation 5.2: We get

$$\begin{aligned} \frac{1}{2} \int_0^{2\pi} \{ \langle \gamma_2 \dot{\gamma}_2^{-1}, X_2 \rangle - \langle \gamma_2^{-1} \gamma_1^{-1} \dot{\gamma}_1 \gamma_2, \gamma_2^{-1} X_1 \gamma_2 \rangle - \langle \gamma_2^{-1} \gamma_1^{-1} \dot{\gamma}_1 \gamma_2, X_2 \rangle \\ - \langle \gamma_2^{-1} \dot{\gamma}_2, \gamma_2^{-1} X_1 \gamma_2 \rangle - \langle \gamma_2^{-1} \dot{\gamma}_2, X_2 \rangle + \langle \gamma_1^{-1} \dot{\gamma}_1, X_1 \rangle \} dt , \end{aligned}$$

which is equal to

$$\frac{1}{2} \int_0^{2\pi} \{ -\langle \gamma_1^{-1} \dot{\gamma}_1, \gamma_2 X_2 \gamma_2^{-1} \rangle - \langle \dot{\gamma}_2 \gamma_2^{-1}, X_1 \rangle \} dt ,$$

which in turn equals

$$\frac{1}{2} \int_0^{2\pi} \{ \langle X_1, \dot{\gamma}_2 \gamma_2^{-1} \rangle - \langle \gamma_1^{-1} \dot{\gamma}_1, \gamma_2 X_2 \gamma_2^{-1} \rangle \} dt - \frac{1}{2\pi} \int_0^{2\pi} \langle X_1, \dot{\gamma}_2 \gamma_2^{-1} \rangle dt .$$

- Proof of equation 5.3: we get

$$\begin{aligned}
p^*b(\gamma; \gamma X) &= b(p\gamma p^{-1}; p\gamma p^{-1}(pXp^{-1})) \\
&= \frac{1}{2} \int_0^{2\pi} \langle p\gamma p^{-1}(\dot{p}\gamma p^{-1} + p\dot{\gamma}p^{-1} - p\gamma p^{-1}\dot{p}p^{-1}, pXp^{-1}) \rangle dt \\
&= \frac{1}{2} \int_0^{2\pi} \langle p\gamma^{-1}p^{-1}\dot{p}\gamma p^{-1} + p\gamma^{-1}\dot{\gamma}p^{-1} - \dot{p}p^{-1}, pXp^{-1} \rangle dt \\
&= \frac{1}{2} \int_0^{2\pi} \langle \gamma^{-1}p^{-1}\dot{p}\gamma + \gamma^{-1}\dot{\gamma} - p^{-1}\dot{p}, X \rangle dt \\
&= b(\gamma, \gamma X) + \frac{1}{2} \int_0^{2\pi} \langle \gamma^{-1}p^{-1}\dot{p}\gamma - p^{-1}\dot{p}, X \rangle dt \\
&= b(\gamma, \gamma X) + \frac{1}{2} \int_0^{2\pi} \langle \gamma^{-1}p^{-1}\dot{p}\gamma + p^{-1}\dot{p}, X \rangle dt - \frac{1}{2\pi} \int_0^{2\pi} \langle p^{-1}\dot{p}, X \rangle dt
\end{aligned}$$

The three conditions in proposition 5.1.24 are satisfied and, therefore, the desired isomorphism is established. \square

Proposition 5.1.28. *The strict 2-group $\text{String}_{\text{Mick}}$ from definition 5.1.26 is equivalent to the model $\Xi(\hat{\Omega}_{\text{th}}\text{Spin} \rightarrow P_{\text{th}})\text{Spin}$ from def. 5.1.20.*

Proof. We define a morphism $F : \mathbf{B}\text{String}_{\text{Mick}} \rightarrow \mathbf{B}\Xi(\hat{\Omega}_{\text{th}}\text{Spin} \rightarrow P_{\text{th}})\text{Spin}$. Its action on 1- and 2-morphisms is obvious: it sends parameterized paths $\gamma : [0, 1] \rightarrow G = \text{Spin}$. to their thin-homotopy equivalence class

$$F : \gamma \mapsto [\gamma]$$

and similarly for parameterized disks. On the \mathbb{R}/\mathbb{Z} -labels of these disks it acts as the identity.

The subtle part is the compositor measuring the coherent failure of this assignment to respect composition: Define the components of this compositor for any two parameterized based paths $\gamma_1, \gamma_2 : [0, 1] \rightarrow G$ with pointwise product $(\gamma_1 \cdot \gamma_2) : [0, 1] \rightarrow G$ and images $[\gamma_1], [\gamma_2], [\gamma_1 \cdot \gamma_2]$ in thin homotopy classes to be represented by a parameterized disk in G

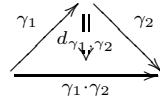

equipped with a label $x_{\gamma_1, \gamma_2} \in \mathbb{R}/\mathbb{Z}$ to be determined. Notice that this triangle is a diagram in $\Xi(\hat{\Omega}_{\text{th}}\text{Spin} \rightarrow P_{\text{th}})\text{Spin}$, so that composition of 1-morphisms is concatenation $\gamma_1 \circ \gamma_2$ of paths. A suitable disk in G is obtained via the map

$$D^2 \xrightarrow{a} [0, 1]^2 \xrightarrow{(s_1, s_2) \mapsto \gamma_1(s_1) \cdot \gamma_2(s_2)} G ,$$

where a is a smooth surjection onto the triangle $\{(s_1, s_2) | s_2 \leq s_1\} \subset [0, 1]^2$ such that the lower semi-circle of $\partial D^2 = S^1$ maps to the hypotenuse of this triangle. The coherence law for this compositor for all triples of parameterized paths $\gamma_1, \gamma_2, \gamma_3 : [0, 1] \rightarrow G$ amounts to the following: consider the map

$$D^3 \xrightarrow{a} [0, 1]^3 \xrightarrow{(s_1, s_2, s_3) \mapsto \gamma_1(s_1) \cdot \gamma_2(s_2) \cdot \gamma_3(s_3)} G ,$$

where the map a is a smooth surjection onto the tetrahedron $\{(s_3 \leq s_2 \leq s_1)\} \subset [0, 1]^3$. Then the coherence

condition

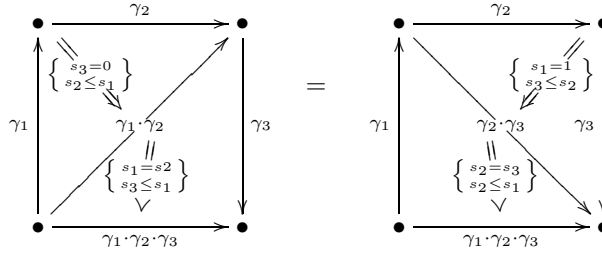

requires that the integral of the canonical 3-form on G pulled back to the 3-ball along these maps accounts for the difference in the chosen labels of the disks involved:

$$\int_{D^3} (b \circ a)^* \mu = \int_{s_3 \leq s_2 \leq s_1} (\gamma_1 \cdot \gamma_2 \cdot \gamma_3)^* \mu = x_{\gamma_1, \gamma_2} + x_{\gamma_1 \cdot \gamma_2, \gamma_3} - x_{\gamma_1, \gamma_2 \cdot \gamma_3} - x_{\gamma_2, \gamma_3} \in \mathbb{R}/\mathbb{Z}.$$

(Notice that there is no further twist on the right hand side because whiskering in $\mathbf{B}\Xi(\hat{\Omega}_{\text{th}}G \rightarrow P_{\text{th}}G)$ does not affect the labels of the disks.) To solve this condition, we need a 2-form to integrate over the triangles. This is provided by the degree 2 component of the simplicial realization $(\mu, \nu) \in \Omega^3(G) \times \Omega^2(G \times G)$ of the first Pontryagin form as a simplicial form on $\mathbf{B}G_{\text{ch}}$:

for \mathfrak{g} a semisimple Lie algebra, the image of the normalized invariant bilinear polynomial $\langle \cdot, \cdot \rangle$ under the Chern-Weil map is $(\mu, \nu) \in \Omega^3(G) \times \Omega^2(G \times G)$ with

$$\mu := \langle \theta \wedge [\theta \wedge \theta] \rangle$$

and

$$\nu := \langle \theta_1 \wedge \bar{\theta}_2 \rangle,$$

where θ is the left-invariant canonical \mathfrak{g} -valued 1-form on G and $\bar{\theta}$ the right-invariant one.

So, define the label assigned by our compositor to the disks considered above by

$$x_{\gamma_1, \gamma_2} := \int_{s_2 \leq s_1} (\gamma_1, \gamma_2)^* \nu.$$

To show that this assignment satisfies the above condition, use the closedness of (μ, ν) in the complex of simplicial forms on $\mathbf{B}G_{\text{ch}}$: $\delta\mu = d\nu$ and $\delta\nu = 0$. From this one obtains

$$(\gamma_1 \cdot \gamma_2 \cdot \gamma_3)^* \mu = -d(\gamma_1 \cdot \gamma_2, \gamma_3)^* \nu = -d(\gamma_1, \gamma_2 \cdot \gamma_3)^* \nu$$

and

$$(\gamma_1, \gamma_2 \cdot \gamma_3)^* \nu = (\gamma_1 \cdot \gamma_2, \gamma_3)^* \nu + (\gamma_1, \gamma_2)^* \nu - (\gamma_2, \gamma_3)^* \nu.$$

Now we compute as follows: Stokes' theorem gives

$$\int_{s_3 \leq s_2 \leq s_1} (\gamma_1 \cdot \gamma_2 \cdot \gamma_3)^* \mu = \left(\int_{s_3=0, s_2 \leq s_1} + \int_{s_1=s_2, s_3 \leq s_1} - \int_{s_1=1, s_3 \leq s_2} - \int_{s_2=s_3, s_2 \leq s_1} \right) (\gamma_1, \gamma_2 \cdot \gamma_3)^* \nu.$$

The first integral is manifestly equal to x_{γ_1, γ_2} . The last integral is manifestly equal to $-x_{\gamma_1, \gamma_2 \cdot \gamma_3}$. For the remaining two integrals we rewrite

$$\cdots = x_{\gamma_1, \gamma_2} - x_{\gamma_1, \gamma_2 \cdot \gamma_3} + \left(\int_{s_1=s_2, s_3 \leq s_1} - \int_{s_1=1, s_3 \leq s_2} \right) ((\gamma_1 \cdot \gamma_2, \gamma_3)^* \nu + (\gamma_1, \gamma_2)^* \nu - (\gamma_2, \gamma_3)^* \nu).$$

The first term in the integrand now manifestly yields $x_{\gamma_1 \cdot \gamma_2, \gamma_3} - x_{\gamma_2, \gamma_3}$. The second integrand vanishes on the integration domain. The third integrand, finally, gives the same contribution under both integrals and thus drops out due to the relative sign. So in total what remains is indeed

$$\dots = x_{\gamma_1, \gamma_2} - x_{\gamma_1, \gamma_2, \gamma_3} + x_{\gamma_1 \cdot \gamma_2, \gamma_3} - x_{\gamma_2, \gamma_3}.$$

This establishes the coherence condition for the compositor.

Finally we need to show that the compositor is compatible with the horizontal composition of 2-morphisms. We consider this in two steps, first for the horizontal composition of two 2-morphisms both starting at the identity 1-morphism in $\mathbf{BString}_{\text{Mick}}(G)$ – this is the product in the loop group $\hat{\Omega}G$ centrally extended using Mickelsson’s cocycle – then for the horizontal composition of an identity 2-morphism in $\mathbf{BString}_{\text{Mick}}(G)$ with a 2-morphism starting at the identity 1-morphisms – this is the action of PG on $\hat{\Omega}G$. These two cases then imply the general case.

- Let (d_1, x_1) and (d_2, x_2) represent two 2-morphisms in $\mathbf{BString}_{\text{Mick}}$ starting at the identity 1-morphisms. So

$$d_i : [0, 1] \rightarrow \Omega G$$

is a based path in loops in G and $x_i \in U(1)$. We need to show that

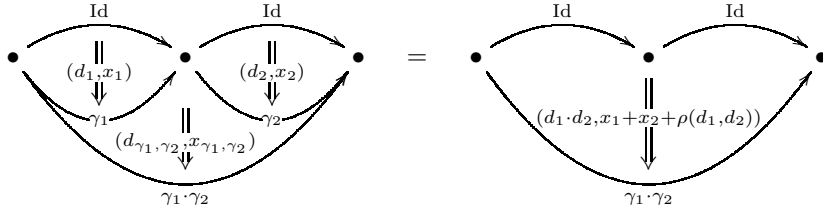

as a pasting diagram equation in $\mathbf{B}\Xi(\hat{\Omega}_{\text{th}}G \rightarrow P_{\text{th}}G)$. Here on the left we have gluing of disks in G along their boundaries and addition of their labels, while on the right we have the pointwise product from definition 5.1.26 of labeled disks as representing the product of elements $\hat{\Omega}G$.

There is an obvious 3-ball interpolating between the disk on the left and on the right of the above equation:

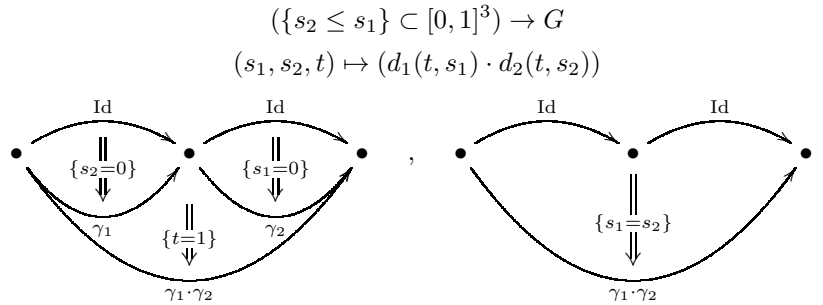

The compositor property demands that the integral of the canonical 3-form over this ball accounts for the difference between x_{γ_1, γ_2} and $\rho(\gamma_1, \gamma_2)$

$$\rho(d_1, d_2) = \int_{\substack{s_2 \leq s_1 \\ 0 \leq t \leq 1}} (d_1 \cdot d_2)^* \mu + \int_{s_2 \leq s_1} (\gamma_1, \gamma_2)^* \nu.$$

Now use again the relation between μ and $d\nu$ to rewrite this as

$$\dots = \int_{\substack{s_2 \leq s_1 \\ 0 \leq t \leq 1}} ((d_1)^* \mu + (d_2)^* \mu - d(d_1, d_2)^* \nu) + \int_{s_2 \leq s_1} (\gamma_1, \gamma_2)^* \nu.$$

The first two integrands vanish. The third one leads to boundary integrals

$$\dots = - \left(\int_{s_2=0} + \int_{s_1=0} \right) (d_1, d_2)^* \nu - \int_{\substack{t=1 \\ s_2 \leq s_1}} (d_1, d_2)^* \nu + \int_{s_2 \leq s_1} (\gamma_1, \gamma_2)^* \nu + \int_{\substack{0 \leq t \leq 1 \\ s_1 = s_2}} (d_1, d_2)^* \nu.$$

The first two integrands vanish on their integration domain. The third integral cancels with the fourth one. The remaining fifth one is indeed the 2-cocycle on $P\Omega G$ from definition 5.1.26.

- The second case is entirely analogous: for γ_1 a path and (d_2, x_2) a centrally extended loop we need to show that

There is an obvious 3-ball interpolating between the disk on the left and on the right of the above equation:

$$\begin{aligned} & (\{s_2 \leq s_1\} \subset [0, 1]^3) \rightarrow G \\ & (s_1, s_2, t) \mapsto (\gamma_1(s_1) \cdot d_2(t, s_2)) \end{aligned}$$

The compositor property demands that the integral of the canonical 3-form over this ball accounts for the difference between x_{γ_1, γ_2} and $\lambda(\gamma_1, \gamma_2)$

$$\lambda(\gamma_1, d_2) = \int_{\substack{s_2 \leq s_1 \\ 0 \leq t \leq 1}} (d_1 \cdot d_2)^* \mu + \int_{s_2 \leq s_1} (\gamma_1, \gamma_2)^* \nu.$$

This is essentially the same computation as before, so that the result is

$$\dots = \int_{\substack{0 \leq t \leq 1 \\ s_1 = s_2}} (\gamma_1, d_2)^* \nu.$$

This is indeed the quantity from definition 5.1.26. □

Applied to the case $G = \text{Spin}$ in summary this shows that all these strict smooth 2-groups are indeed presentations of the abstractly defined smooth String 2-group from def. 5.1.10.

Theorem 5.1.29. *We have equivalences of smooth 2-groups*

$$\text{String} \simeq \Omega \text{cosk}_3 \exp(\mathfrak{so}_\mu) \simeq \text{String}_{\text{BCSS}} \simeq \text{String}_{\text{Mick}}.$$

Notice that all the models on the right are degreewise diffeological and in fact Fréchet, but not degreewise finite dimensional. This means that neither of these models is a differentiable stack or Lie groupoid in the traditional sense, even though they are perfectly good models for objects in $\text{Smooth}\infty\text{Grpd}$. Some authors found this to be a deficiency. Motivated by this it has been shown in [Scho10] that there exist finite dimensional models of the smooth String-group. Observe however the following:

1. If one allows arbitrary disjoint unions of finite dimensional manifolds, then by prop. 2.2.18 every object in $\text{Smooth}\infty\text{Grpd}$ has a presentation by a simplicial object that is degreewise of this form, even a presentation which is degreewise a union of just Cartesian spaces.
2. Contrary to what one might expect, it is not the degreewise finite dimensional models that seem to lend themselves most directly to differential refinements and differential geometric computations with objects in $\text{Smooth}\infty\text{Grpd}$, but the models of the form $\mathbf{cosk}_n \exp(\mathfrak{g})$. See also the discussion in 5.2.7.3 below.

5.1.5 Smooth fivebrane structure and the Fivebrane-6-group

We now climb up one more step in the smooth Whitehead tower of the orthogonal group, to find a smooth and differential refinement of the *Fivebrane group* [SSS09b].

Proposition 5.1.30. *Pulled back along $B\text{String} \rightarrow BO$ the second Pontryagin class is 6 times a generator $\frac{1}{6}p_2$ of $H^8(B\text{String}, \mathbb{Z}) \simeq \mathbb{Z}$:*

$$\begin{array}{ccc} B\text{String} & \xrightarrow{\frac{1}{6}p_2} & B^8\mathbb{Z} \\ \downarrow & & \downarrow \cdot 6 \\ B\text{Spin} & \xrightarrow{p_2} & B^8\mathbb{Z} \end{array} .$$

This is due to [Bott58]. We call $\frac{1}{6}p_2$ the *second fractional Pontryagin class* .

Definition 5.1.31. Write $B\text{Fivebrane}$ for the homotopy fiber of the second fractional Pontryagin class in $\text{Top} \simeq \infty\text{Grpd}$

$$\begin{array}{ccc} B\text{Fivebrane} & \longrightarrow & * \\ \downarrow & & \downarrow \\ B\text{String} & \xrightarrow{\frac{1}{6}p_2} & B^8\mathbb{Z} \end{array} .$$

Write

$$\text{Fivebrane} := \Omega B\text{Fivebrane}$$

for its loop space, the topological *fivebrane* ∞ -group.

This is the next step in the topological Whitehead tower of O after String, often denoted $O\langle 7 \rangle$. For a discussion of its role in the physics of super-Fivebranes that gives it its name here in analogy to String = $O\langle 3 \rangle$ see [SSS09b]. See also [DHH10], around remark 2.8. We now construct smooth and then differential refinements of this object.

Theorem 5.1.32. *The image under Lie integration, 4.4.14, of the canonical Lie algebra 7-cocycle*

$$\mu_7 = \langle -, [-, -], [-, -], [-, -] \rangle : \mathfrak{so}_{\mu_3} \rightarrow b^6\mathbb{R}$$

on the string Lie 2-algebra \mathfrak{so}_{μ_3} , def. 5.1.15, is a morphism in $\text{Smooth}\infty\text{Grpd}$ of the form

$$\frac{1}{6}\mathbf{p}_2 : \mathbf{B}\text{String} \rightarrow \mathbf{B}^7U(1)$$

whose image under the fundamental ∞ -groupoid ∞ -functor/ geometric realization, 4.3.4, $\Pi : \text{Smooth}\infty\text{Grpd} \rightarrow \infty\text{Grpd}$ is the ordinary second fractional Pontryagin class $\frac{1}{6}p_2 : B\text{String} \rightarrow B^8\mathbb{Z}$ in Top . We call $\frac{1}{6}\hat{p}_2 := \exp(\mu_7)$ the second smooth fractional Pontryagin class

Moreover, the corresponding refined differential characteristic cocycle, 4.4.17,

$$\frac{1}{6}\hat{p}_2 : \mathbf{H}_{\text{conn}}(-, \mathbf{B}\text{Spin}) \rightarrow \mathbf{H}_{\text{diff}}(-, \mathbf{B}^7U(1)),$$

induces in cohomology the ordinary refined Chern-Weil homomorphism [HoSi05]

$$[\frac{1}{6}\hat{p}_2] : H_{\text{Smooth}}^1(X, \text{String}) \rightarrow H_{\text{diff}}^4(X)$$

of $\langle -, -, -, - \rangle$ restricted to those Spin -principal bundles P that have String -lifts

$$[P] \in H_{\text{smooth}}^1(X, \text{String}) \hookrightarrow H_{\text{smooth}}^1(X, \text{Spin}).$$

Proof. This is shown in [FSS10]. The proof is analogous to that of prop. 5.1.9. □

Definition 5.1.33. Write $\mathbf{B}\text{Fivebrane}$ for the homotopy fiber in $\text{Smooth}\infty\text{Grpd}$ of the smooth refinement of the second fractional Pontryagin class, prop. 5.1.32:

$$\begin{array}{ccc} \mathbf{B}\text{Fivebrane} & \longrightarrow & * \\ \downarrow & & \downarrow \\ \mathbf{B}\text{String} & \xrightarrow{\frac{1}{6}\hat{p}_2} & \mathbf{B}^7U(1) \end{array} .$$

We say its loop space object is the *smooth fivebrane 6-group*

$$\text{Fivebrane}_{\text{smooth}} := \Omega\mathbf{B}\text{Fivebrane} .$$

This has been considered in [SSS09c]. Similar discussion as for the smooth String 2-group applies.

5.1.6 Higher Spin^c -structures

In 5.1 we saw that the classical extension

$$\mathbb{Z}_2 \rightarrow \text{Spin}(n) \rightarrow \text{SO}(n)$$

is only the first step in a tower of *smooth* higher spin groups.

There is another classical extension of $\text{SO}(n)$, not by \mathbb{Z}_2 but by the circle group [LaMi89]:

$$U(1) \rightarrow \text{Spin}^c(n) \rightarrow \text{SO}(n).$$

Here we discuss higher smooth analogs of this construction.

This section draws from [FSS12b].

We find below that Spin^c is a special case of the following simple general notion, that turns out to be useful to identify and equip with a name.

Definition 5.1.34. Let \mathbf{H} be an ∞ -topos, $G \in \infty\text{Grp}(\mathbf{H})$ an ∞ -group object, let A be an abelian group object and let

$$\mathbf{p} : \mathbf{B}G \rightarrow \mathbf{B}^{n+1}A$$

be a characteristic map. Write $\hat{G} \rightarrow G$ for the extension classified by \mathbf{p} , exhibited by a fiber sequence

$$\mathbf{B}^n A \rightarrow \hat{G} \rightarrow G$$

in \mathbf{H} . Then for $H \in \infty\text{Grp}(\mathbf{H})$, any other ∞ -group with characteristic map of the same form

$$\mathbf{c} : \mathbf{B}H \rightarrow \mathbf{B}^{n+1}A$$

we write

$$\hat{G}^{\mathbf{c}} := \Omega(\mathbf{B}G_{\mathbf{p}} \times_{\mathbf{c}} \mathbf{B}H) \in \infty\text{Grp}(\mathbf{H})$$

for the loop space object of the ∞ -pullback

$$\begin{array}{ccc} \mathbf{B}\hat{G}^{\mathbf{c}} & \longrightarrow & \mathbf{B}H \\ \downarrow & & \downarrow \mathbf{c} \\ \mathbf{B}G & \xrightarrow{\mathbf{p}} & \mathbf{B}^{n+1}A \end{array} .$$

Remark 5.1.35. Since the Eilenberg-MacLane object $\mathbf{B}^{n+1}A$ is itself an ∞ -group object, by the Mayer-Vietoris fiber sequence in \mathbf{H} , prop. 3.6.142, the object $\mathbf{B}\hat{G}^{\mathbf{c}}$ is equivalently the homotopy fiber of the difference $(\mathbf{p} - \mathbf{c})$ of the two characteristic maps

$$\begin{array}{ccc} \mathbf{B}\hat{G}^{\mathbf{c}} & \xrightarrow{\quad} & * \\ \downarrow & & \downarrow \\ \mathbf{B}G \times \mathbf{B}H & \xrightarrow{\mathbf{p} - \mathbf{c}} & \mathbf{B}^n A \end{array} .$$

5.1.7 Spin^c as a homotopy fiber product in $\text{Smooth}\infty\text{Grpd}$

A classical definition of Spin^c is the following (for instance [LaMi89]).

Definition 5.1.36. For each $n \in \mathbb{N}$ the Lie group $\text{Spin}^c(n)$ is the fiber product of Lie groups

$$\begin{aligned} \text{Spin}^c(n) &:= \text{Spin}(n) \times_{\mathbb{Z}_2} U(1) \\ &= (\text{Spin}(n) \times U(1)) / \mathbb{Z}_2, \end{aligned}$$

where the quotient is by the canonical subgroup embeddings.

We observe now that in the context of $\text{Smooth}\infty\text{Grpd}$ this Lie group has the following intrinsic characterization.

Proposition 5.1.37. *In $\text{Smooth}\infty\text{Grpd}$ we have an ∞ -pullback diagram of the form*

$$\begin{array}{ccc} \mathbf{B}\text{Spin}^c & \longrightarrow & \mathbf{B}U(1) \\ \downarrow & & \downarrow \mathbf{c}_1 \bmod 2 \\ \mathbf{B}\text{SO} & \xrightarrow{\mathbf{w}_2} & \mathbf{B}^2\mathbb{Z}_2 \end{array} ,$$

where the right morphism is the smooth universal first Chern class, example 1.2.135, composed with the mod-2 reduction $\mathbf{B}\mathbb{Z} \rightarrow \mathbf{B}\mathbb{Z}_2$, and where \mathbf{w}_2 is the smooth universal second Stiefel-Whitney class, example 1.2.139.

Proof. By the discussion at these examples, these universal smooth classes are represented by spans of simplicial presheaves

$$\begin{array}{ccc} \mathbf{B}(\mathbb{Z} \rightarrow \mathbb{R})_{\text{ch}} & \xrightarrow{\mathbf{c}_1} & \mathbf{B}(\mathbb{Z} \rightarrow 1)_{\text{ch}} \equiv \mathbf{B}^2\mathbb{Z} \\ \downarrow \simeq & & \\ \mathbf{B}U(1)_{\text{ch}} & & \end{array}$$

and

$$\begin{array}{ccc} \mathbf{B}(\mathbb{Z}_2 \rightarrow \text{Spin})_{\text{ch}} & \longrightarrow & \mathbf{B}(\mathbb{Z}_2 \rightarrow 1)_{\text{ch}} \equiv \mathbf{B}^2(\mathbb{Z}_2)_{\text{ch}} . \\ \downarrow \simeq & & \\ \mathbf{B}\text{SO}_{\text{ch}} & & \end{array}$$

Here both horizontal morphism are fibrations in $[\text{CartSp}_{\text{smooth}}^{\text{op}}, \text{sSet}]_{\text{proj}}$. Therefore by prop. 2.3.13 the ∞ -pullback in question is given by the ordinary fiber product of these two morphisms. This is

$$\begin{array}{ccc} \mathbf{B}(\mathbb{Z} \rightarrow \text{Spin} \times \mathbb{R})_{\text{ch}} & \longrightarrow & \mathbf{B}(\mathbb{Z} \rightarrow \mathbb{R})_{\text{ch}} , \\ \downarrow & & \downarrow \\ \mathbf{B}(\mathbb{Z} \xrightarrow{\text{mod } 2} \text{Spin})_{\text{ch}} & \longrightarrow & \mathbf{B}(\mathbb{Z} \rightarrow 1)_{\text{ch}} \\ \downarrow & & \downarrow \\ \mathbf{B}(\mathbb{Z}_2 \rightarrow \text{Spin})_{\text{ch}} & \longrightarrow & \mathbf{B}(\mathbb{Z}_2 \rightarrow 1)_{\text{ch}} \end{array}$$

where the crossed module $(\mathbb{Z} \xrightarrow{\partial} \text{Spin} \times \mathbb{R})$ is given by

$$\partial : n \mapsto (n \bmod 2, n) .$$

Since this is a monomorphism, including (over the neutral element) the fiber of a locally trivial bundle we have an equivalence

$$\mathbf{B}(\mathbb{Z} \rightarrow \text{Spin} \times \mathbb{R}) \xrightarrow{\simeq} \mathbf{B}(\mathbb{Z}_2 \rightarrow \text{Spin} \times U(1)) \xrightarrow{\simeq} \mathbf{B}(\text{Spin} \times_{\mathbb{Z}_2} U(1))$$

in $[\text{CartSp}^{\text{op}}, \text{sSet}]_{\text{proj}}$. On the right is, by def. 5.1.36, the delooping of Spin^c . □

Remark 5.1.38. Therefore by def. 5.1.34 we have

$$\text{Spin}^c \simeq \text{Spin}^{\mathbf{c}_1 \bmod 2} ,$$

which is the very motivation for the notation in that definition.

Remark 5.1.39. From prop. 5.1.37 we obtain the following characterization of Spin^c -structures in $\mathbf{H} = \text{Smooth}\infty\text{Grpd}$ over a smooth manifold expressed in terms of traditional Čech cohomology, 4.3.8.1.

For $X \in \text{SmthMfd}$, the fact that $\mathbf{H}(X, -)$ preserves ∞ -limits implies from prop. 5.1.37 that we have an ∞ -pullback of cocycle ∞ -groupoids

$$\begin{array}{ccc} \mathbf{H}(X, B\text{Spin}^c) & \longrightarrow & \mathbf{H}(X, \mathbf{B}U(1)) \\ \downarrow & & \downarrow c_1 \bmod 2 \\ \mathbf{H}(X, \mathbf{B}SO) & \xrightarrow{w_2} & \mathbf{H}(X, \mathbf{B}^2\mathbb{Z}_2) \end{array} .$$

Picking any choice of differentiably good open cover $\{U_i \rightarrow X\}$ of X and using the standard presentation of the coefficient moduli stacks appearing here by sheaves of groupoids as discussed in 4.4.2, each of the four ∞ -groupoids appearing here is canonically identified with the groupoid (or 2-groupoid in the bottom right) of Čech cocycles and Čech coboundaries with respect to the given cover and with coefficients in the given group. Moreover, in this presentation the right vertical morphism of the above diagram is clearly a fibration, and so by prop. 2.3.8 the ordinary pullback of these groupoids is already the correct ∞ -pullback, hence is the groupoid $\mathbf{H}(X, \mathbf{B}\text{Spin}^c)$ of Spin^c -structure on X . So we read off from the diagram and the construction in the above proof: given a Čech 1-cocycle for an SO -structure on X the corresponding Spin^c -structure is a lift to a $(\mathbb{Z} \rightarrow \mathbb{R})$ -valued Čech cocycle of the \mathbb{Z}_2 -valued Čech 2-cocycle that represents the second Stiefel-Whitney class, as described in 1.2.139, through the evident projection $(\mathbb{Z} \rightarrow \mathbb{R}) \rightarrow (\mathbb{Z}_2 \rightarrow *)$ that by example. 1.2.135 presents the universal first Chern class.

5.1.8 Smooth String^{c_2}

We consider smooth 2-groups of the form String^c , according to def. 5.1.34, where $\mathbf{B}U(1) \rightarrow \text{String} \rightarrow \text{Spin}$ in $\text{Smooth}\infty\text{Grpd}$ is the smooth String -2-group extension of the Spin -group from def. 5.1.10.

In [Sa10c] the following notion is introduced.

Definition 5.1.40. Let

$$p_1^c : B\text{Spin}^c \rightarrow B\text{Spin} \xrightarrow{\frac{1}{2}p_1} K(\mathbb{Z}, 4)$$

in $\text{Top} \simeq \infty\text{Grpd}$, where the first map is induced on classifying spaces by the defining projection, def. 5.1.36, and where the second represents the fractional first Pontryagin class from prop. 5.1.5.

Then write String^c for the topological group, well defined up to weak homotopy equivalence, that models the loop space of the homotopy pullback

$$\begin{array}{ccc} B\text{String}^c & \longrightarrow & (BU(1)) \times (BU(1)) \\ \downarrow & & \downarrow c_1 \cup c_1 \\ B\text{Spin}^c & \xrightarrow{p_1^c} & K(\mathbb{Z}, 4) \end{array}$$

in Top .

This construction, and the role it plays in [Sa10c], is evidently an example of general structure of def. 5.1.34, the notation of which is motivated from this example. We consider now smooth and differential refinements of such objects.

To that end, recall from theorem. 5.1.9 the smooth refinement of the first fractional Pontryagin class

$$\frac{1}{2}p_1 : \mathbf{B}\text{Spin} \rightarrow \mathbf{B}^3U(1)$$

and from def. 5.1.10 the defining fiber sequence

$$\mathbf{B}\text{String} \longrightarrow \mathbf{B}\text{Spin} \xrightarrow{\frac{1}{2}p_1} \mathbf{B}^3U(1) .$$

The proof of theorem 5.1.9 rests only on the fact that Spin is a compact and simply connected simple Lie group. The same is true for the special unitary group SU and the exceptional Lie group E_8 .

Proposition 5.1.41. *The first two non-vanishing homotopy groups of E_8 are*

$$\pi_3(E_8) \simeq \mathbb{Z}$$

and

$$\pi_{15}(E_8) \simeq \mathbb{Z}.$$

This is a classical fact[BoSa58]. It follows with the Hurewicz theorem that

$$H^4(BE_8, \mathbb{Z}) \simeq \mathbb{Z}.$$

Therefore the generator of this group is, up to sign, a canonical characteristic class, which we write

$$[a] \in H^4(BE_8, \mathbb{Z})$$

corresponding to a characteristic map $a : BE_8 \rightarrow K(\mathbb{Z}, 4)$. Hence we obtain analogously the following statements.

Corollary 5.1.42. *The second Chern-class*

$$c_2 : BSU \rightarrow K(\mathbb{Z}, 4)$$

has an essentially unique lift through $\Pi : \text{Smooth}\infty\text{Grpd} \rightarrow \infty\text{Grpd} \simeq \text{Top}$ to a morphism of the form

$$\mathbf{c}_2 : \mathbf{B}SU \rightarrow \mathbf{B}^3U(1)$$

and a representative is provided by the Lie integration $\exp(\mu_3^{\text{su}})$ of the canonical Lie algebra 3-cocycle $\mu_3^{\text{su}} : \mathfrak{su} \rightarrow b^2\mathbb{R}$

$$\mathbf{c}_2 \simeq \exp(\mu_3^{\text{su}}).$$

Similarly the characteristic map

$$a : BE_8 \rightarrow K(\mathbb{Z}, 4)$$

has an essentially unique lift through $\Pi : \text{Smooth}\infty\text{Grpd} \rightarrow \infty\text{Grpd} \simeq \text{Top}$ to a morphism of the form

$$\mathbf{a} : \mathbf{B}E_8 \rightarrow \mathbf{B}^3U(1)$$

and a representative is provided by the Lie integration $\exp(\mu_3^{\text{e}_8})$ of the canonical Lie algebra 3-cocycle $\mu_3^{\text{e}_8} : \mathfrak{e}_8 \rightarrow b^2\mathbb{R}$

$$\mathbf{a} \simeq \exp(\mu_3^{\text{e}_8}).$$

Therefore we are entitled to the following special case of def. 5.1.34.

Definition 5.1.43. The smooth 2-group

$$\text{String}^{\mathbf{c}_2} \in \infty\text{Grp}(\text{Smooth}\infty\text{Grpd})$$

is the loop space object of the ∞ -pullback

$$\begin{array}{ccc} \mathbf{B}\text{String}^{\mathbf{c}_2} & \longrightarrow & \mathbf{B}SU \\ \downarrow & & \downarrow \mathbf{c}_2 \\ \mathbf{B}\text{Spin} & \xrightarrow{\frac{1}{2}\mathbf{p}_1} & \mathbf{B}^3U(1) \end{array} .$$

Analogously, the smooth 2-group

$$\text{String}^{\mathfrak{a}} \in \infty\text{Grp}(\text{Smooth}\infty\text{Grpd})$$

is the loop space object of the ∞ -pullback

$$\begin{array}{ccc} \mathbf{B}\text{String}^{\mathfrak{a}} & \longrightarrow & \mathbf{B}E_8 \\ \downarrow & & \downarrow \mathfrak{a} \\ \mathbf{B}\text{Spin} & \xrightarrow{\frac{1}{2}\mathfrak{p}_1} & \mathbf{B}^3U(1) \end{array} .$$

Remark 5.1.44. By prop. 3.6.142, $\text{String}^{\mathfrak{a}}$ is equivalently is the homotopy fiber of the difference $\frac{1}{2}\mathfrak{p}_1 - \mathfrak{a}$

$$\begin{array}{ccc} \mathbf{B}\text{String}^{\mathfrak{a}} & \longrightarrow & * \\ \downarrow & & \downarrow \\ \mathbf{B}(\text{Spin} \times E_8) & \xrightarrow{\frac{1}{2}\mathfrak{p}_1 - \mathfrak{a}} & \mathbf{B}^3U(1) \end{array} .$$

We consider now a presentation of $\text{String}^{\mathfrak{a}}$ by Lie integration, as in 4.4.14.

Definition 5.1.45. Let

$$(\mathfrak{so} \otimes \mathfrak{e}_8)_{\mu_3^{\mathfrak{so}} - \mu_3^{\mathfrak{e}_8}} \in L_{\infty}\text{Alg}$$

be the L_{∞} -algebra extension, according to def. 4.4.105, of the tensorproduct Lie algebra $\mathfrak{so} \otimes \mathfrak{e}_8$ by the difference of the canonical 3-cocycles on the two factors.

Proposition 5.1.46. *The Lie integration, def. 4.4.56, of the Lie 2-algebra $(\mathfrak{so} \otimes \mathfrak{e}_8)_{\mu_3^{\mathfrak{so}} - \mu_3^{\mathfrak{e}_8}}$ is a presentation of $\text{String}^{\mathfrak{a}}$:*

$$\text{String}^{\mathfrak{a}} \simeq \tau_2 \exp \left((\mathfrak{so} \otimes \mathfrak{e}_8)_{\mu_3^{\mathfrak{so}} - \mu_3^{\mathfrak{e}_8}} \right)$$

Proof. With remark 5.1.44 this is directly analogous to prop. 5.1.17. □

Remark 5.1.47. Therefore a 2-connection on a $\text{String}^{\mathfrak{a}}$ -principal 2-bundle is locally given by

- an \mathfrak{so} -valued 1-form ω ;
- an \mathfrak{e}_8 -valued 1-form A ;
- a 2-form B ;

such that the 3-form curvature of B is, locally, the sum of the de Rham differential of B with the difference of the Chern-Simons forms of ω and A , respectively:

$$H_3 = dB + \text{cs}(\omega) - \text{cs}(A).$$

We discuss the role of such 2-connections in string theory below in 5.2.7.3.2 and 5.5.9.3.

5.2 Higher prequantum fields

We discuss various examples of *twisted ∞ -bundles*, 3.6.14, and the corresponding *twisted differential structures*, 3.9.8, and interpret these examples as twisted prequantum (boundary) fields, 3.9.14.4, that may appear in local prequantum field theory, 3.9.14, and notably in string theory [Sc12].

Most of these appear in various guises in string theory, which we survey in

- 5.2.6 – Twisted topological c -structures in String theory.

Below we discuss the following differential refinements and applications.

- 5.2.1 – Definition and overview
- 5.2.4 – Reduction of structure groups
 - 5.2.4.1 – Orthogonal/Riemannian structure
 - 5.2.4.2 – Type II generalized geometry
 - 5.2.4.3 – U-duality geometry / exceptional generalized geometry
- 5.2.5 – Orientifolds and higher orientifolds
- 5.2.6 – Twisted topological structures in quantum anomaly cancellation
- 5.2.7 – Twisted differential structures in quantum anomaly cancellation
 - 5.2.7.1 – Twisted differential \mathbf{c}_1 -structures
 - 5.2.7.2 – Twisted differential spin^c -structures
 - 5.2.7.3 – Higher differential spin structures: string and fivebrane structures
- 5.2.9 – The supergravity C -field
- 5.2.10 – Differential T-duality

The discussion in this section draws from [FiSaScI], which in turn draws from the examples discussed in [SSS09c], [FSS12b].

5.2.1 Introduction and Overview

We start with an exposition and overview of the notion of twisted fields in local prequantum field theory. This section is taken from [FSS13a]. See also the lecture notes [Sc12].

While twisted higher (gauge) fields embody much of the subtle structure in string theory backgrounds, actually basic example of them secretly appear all over the place in traditional field theory. For instance the field of gravity in general relativity is a (pseudo-)Riemannian metric on spacetime, and there is no such thing as a moduli stack of (pseudo-)Riemannian metrics on the site of smooth manifolds. This is nothing but the elementary fact that a (pseudo-)Riemannian metric cannot be pulled back along an arbitrary smooth morphism between manifolds, but only along local diffeomorphisms. Translated into the language of stacks, this tells us that (pseudo-)Riemannian metrics is a stack on the étale site of smooth manifolds, but not on the smooth site.¹⁶ Yet we can still look at (pseudo-)Riemannian metrics on a smooth n -dimensional manifold X from the perspective of the topos \mathbf{H} of stacks over the smooth site, and indeed this is the more comprehensive point of view. Namely, working in \mathbf{H} also means to work with all its *slice toposes* (or *over-toposes*) \mathbf{H}/\mathbf{S} over the various objects \mathbf{S} in \mathbf{H} . For the field of gravity this means working in the slice $\mathbf{H}/\mathbf{BGL}(n; \mathbb{R})$ over the stack $\mathbf{BGL}(n; \mathbb{R})$.

¹⁶See [Ca12] for a comprehensive treatment of the étale site of smooth manifolds and of the higher topos of higher stacks over it.

Notice that this terminology is just a concise and rigorous way of expressing a familiar fact from Riemannian geometry: endowing a smooth n -manifold X with a pseudo-Riemannian metric of signature $(p, n - p)$ is equivalent to performing a reduction of the structure group of the tangent bundle of X to $O(p, n - p)$. Indeed, one can look at the tangent bundle (or, more precisely, at the associated frame bundle) as a morphism $\tau_X : X \rightarrow \mathbf{BGL}(n; \mathbb{R})$.

5.2.1.1 Example: Orthogonal structures. The above reduction is then the datum of a homotopy lift of τ_X

$$\begin{array}{ccc} & \mathbf{BO}(p, n - p) & \\ \nearrow^{o_X} & \downarrow & \\ X & \xrightarrow{\tau_X} & \mathbf{BGL}(n; \mathbb{R}), \end{array} \quad \Downarrow_e$$

where the vertical arrow

$$\mathbf{OrthStruc}_n : \mathbf{BO}(p, n - p) \longrightarrow \mathbf{BGL}(n; \mathbb{R})$$

is induced by the inclusion of groups $O(p, n - p) \hookrightarrow GL(n; \mathbb{R})$. Such a commutative diagram is precisely a map

$$(o_X, e) : \tau_X \longrightarrow \mathbf{OrthStruc}_n$$

in the slice $\mathbf{H}/_{\mathbf{BGL}(n; \mathbb{R})}$. The homotopy e appearing in the above diagram is precisely the *vielbein field* (frame field) which exhibits the reduction, hence which induces the Riemannian metric. So the moduli stack of Riemannian metrics in n dimensions is $\mathbf{OrthStruc}_n$, not as an object of the ambient cohesive topos \mathbf{H} , but of the slice $\mathbf{H}/_{\mathbf{BGL}(n)}$. Indeed, a map between manifolds regarded in this slice, namely a map $(\phi, \eta) : \tau_Y \rightarrow \tau_X$, is equivalently a smooth map $\phi : Y \rightarrow X$ in \mathbf{H} , but equipped with an equivalence $\eta : \phi^* \tau_X \rightarrow \tau_Y$. This precisely exhibits ϕ as a local diffeomorphism. In this way the slicing formalism automatically knows along which kinds of maps metrics may be pulled back.

5.2.1.2 Example: (Exceptional) generalized geometry. If we replace in the above example the map $\mathbf{OrthStruc}_n$ with inclusions of other maximal compact subgroups, we similarly obtain the moduli stacks for *generalized geometry* (metric and B-field) as appearing in type II superstring backgrounds (see, e.g., [Hi11]), given by

$$\mathbf{typeII} : \mathbf{B}(O(n) \times O(n)) \longrightarrow \mathbf{BO}(n, n) \in \mathbf{H}/_{\mathbf{BO}(n, n)}$$

and of *exceptional generalized geometry* appearing in compactifications of 11-dimensional supergravity [Hull07], given by

$$\mathbf{ExcSugra}_n : \mathbf{BK}_n \longrightarrow \mathbf{BE}_{n(n)} \in \mathbf{H}/_{\mathbf{BE}_{n(n)}},$$

where $E_{n(n)}$ is the maximally non-compact real form of the Lie group of rank n with E -type Dynkin diagram, and $K_n \subseteq E_{n(n)}$ is a maximal compact subgroup. For instance, a manifold X in type II-geometry is represented by $\tau_X^{\text{gen}} : X \rightarrow \mathbf{BO}(n, n)$ in the slice $\mathbf{H}/_{\mathbf{BO}(n, n)}$, which is the map modulating what is called the *generalized tangent bundle*, and a field of generalized type II gravity is a map $(o_X^{\text{gen}}, e) : \tau_X^{\text{gen}} \rightarrow \mathbf{typeII}$ to the moduli stack in the slice. One checks that the homotopy e is now precisely what is called the *generalized vielbein field* in type II geometry. We read off the kind of maps along which such fields may be pulled back: a map $(\phi, \eta) : \tau_Y^{\text{gen}} \rightarrow \tau_X^{\text{gen}}$ is a *generalized local diffeomorphism*: a smooth map $\phi : Y \rightarrow X$ equipped with an equivalence of generalized tangent bundles $\eta : \phi^* \tau_X^{\text{gen}} \rightarrow \tau_Y^{\text{gen}}$. A directly analogous discussion applies to the exceptional generalized geometry.

Furthermore, various topological structures are generalized fields in this sense, and become fields in the more traditional sense after differential refinement.

5.2.1.3 Example: Spin structures. The map $\mathbf{SpinStruc} : \mathbf{BSpin} \rightarrow \mathbf{BGL}$ is, when regarded as an object of $\mathbf{H}/_{\mathbf{BGL}}$, the moduli stack of spin structures. Its differential refinement $\mathbf{SpinStruc}_{\text{conn}} : \mathbf{BSpin}_{\text{conn}} \rightarrow \mathbf{BGL}_{\text{conn}}$ is such that a domain object $\tau_X^\nabla \in \mathbf{H}/_{\mathbf{GL}_{\text{conn}}}$ is given by an affine connection, and a map $(\nabla_{\text{Spin}}, e) : \tau_X^\nabla \rightarrow \mathbf{SpinStruc}_{\text{conn}}$ is precisely a *Spin connection* and a Lorentz frame/vielbein which identifies ∇ with the corresponding Levi-Civita connection.

This example is the first in a whole tower of *higher Spin structure* fields [SSS09a, SSS09b, SSS09c], each of which is directly related to a corresponding higher Chern-Simons theory. The next higher example in this tower is the following.

5.2.1.4 Example: Heterotic fields. For $n \geq 3$, let **Heterotic** be the map

$$\mathbf{Heterotic} : \mathbf{BSpin}(n) \xrightarrow{(p, \frac{1}{2}\mathbf{p}_1)} \mathbf{BGL}(n; \mathbb{R}) \times \mathbf{B}^3U(1)$$

regarded as an object in the slice $\mathbf{H}/_{\mathbf{BGL}(n; \mathbb{R}) \times \mathbf{B}^3U(1)}$. Here p is the morphism induced by

$$\text{Spin}(n) \rightarrow O(n) \hookrightarrow GL(n; \mathbb{R})$$

while $\frac{1}{2}\mathbf{p}_1 : \mathbf{BSpin}(n) \rightarrow \mathbf{B}^3U(1)$ is the morphism of stacks underlying the first fractional Pontrjagin class, 5.1.8. To regard a smooth manifold X as an object in the slice $\mathbf{H}/_{\mathbf{BGL}(n; \mathbb{R}) \times \mathbf{B}^3U(1)}$ means to equip it with a $U(1)$ -3-bundle $\mathbf{a}_X : X \rightarrow \mathbf{B}^3U(1)$ in addition to the tangent bundle $\tau_X : X \rightarrow \mathbf{BGL}(n; \mathbb{R})$. A Green-Schwarz anomaly-free background field configuration in heterotic string theory is (the differential refinement of) a map $(s_X, \phi) : (\tau_X, \mathbf{a}_X) \rightarrow \mathbf{Heterotic}$, i.e., a homotopy commutative diagram

$$\begin{array}{ccc} X & \xrightarrow{s_X} & \mathbf{BSpin} \\ & \swarrow \phi & \searrow \mathbf{Heterotic} \\ & & \mathbf{BGL}(n) \times \mathbf{B}^3U(1) \end{array}$$

(τ_X, a_X)

The 3-bundle \mathbf{a}_X serves as a twist: when \mathbf{a}_X is trivial then we are in presence of a String structure on X ; so it is customary to refer to (s_X, ϕ) as to an \mathbf{a}_X -twisted *String structure* on X , in the sense of [Wa08, SSS09c]. The Green-Schwarz anomaly cancellation condition is then imposed by requiring that \mathbf{a}_X (or rather its differential refinement) factors as

$$X \longrightarrow \mathbf{BSU} \xrightarrow{\mathbf{c}_2} \mathbf{B}^3U(1) \ ,$$

where $\mathbf{c}_2(E)$ is the morphism of stacks underlying the second Chern class. Notice that this says that the extended Lagrangians of Spin- and SU-Chern-Simons theory in 3-dimensions, as discussed above, at the same time serve as the twists that control the higher background gauge field structure in heterotic supergravity backgrounds.

5.2.1.5 Example: Dual heterotic fields. Similarly, the morphism

$$\mathbf{DualHeterotic} : \mathbf{BString}(n) \xrightarrow{(p, \frac{1}{6}\mathbf{p}_2)} \mathbf{BGL}(n; \mathbb{R}) \times \mathbf{B}^7U(1)$$

governs field configurations for the dual heterotic string. These examples, in their differentially refined version, have been discussed in [SSS09c]. The last example above is governed by the extended Lagrangian of the 7-dimensional Chern-Simons-type higher gauge field theory of String-2-connections. This has been discussed in [FSS12b].

There are many more examples of (quantum) fields modulated by objects in slices of a cohesive higher topos. To close this brief discussion, notice that the previous example has an evident analog in one lower degree: a central extension of Lie groups $A \rightarrow \hat{G} \rightarrow G$ induces a long fiber sequence

$$\underline{A} \longrightarrow \underline{\hat{G}} \longrightarrow \underline{G} \longrightarrow \mathbf{BA} \longrightarrow \mathbf{B}\hat{G} \longrightarrow \mathbf{BG} \xrightarrow{\mathbf{c}} \mathbf{B}^2A$$

in \mathbf{H} , where \mathbf{c} is the group 2-cocycle that classifies the extension. If we regard this as a coefficient object in the slice $\mathbf{H}/_{\mathbf{B}^2A}$, then regarding a manifold X in this slice means to equip it with an $(\mathbf{B}A)$ -principal 2-bundle (an A -bundle gerbe) modulated by a map $\tau_X^A : X \rightarrow \mathbf{B}^2A$; and a field $(\phi, \eta) : \tau_X^A \rightarrow \mathbf{c}$ is equivalently a G -principal bundle $P \rightarrow X$ equipped with an equivalence $\eta : \mathbf{c}(E) \simeq \tau_X^A$ with the 2-bundle which obstructs its lift to a \hat{G} -principal bundle (the “lifting gerbe”). The differential refinement of this setup similarly yields G -gauge fields equipped with such an equivalence. A concrete example for this is discussed below in section 1.2.12.

This special case of fields in a slice is called a *twisted (differential) \hat{G} -structure* in [SSS09c]. In more generality, the terminology *twisted (differential) \mathbf{c} -structures* is used in [SSS09c] to denote spaces of fields of the form $\mathbf{H}/_{\mathbf{S}}(\sigma_X, \mathbf{c})$ for some slice topos $\mathbf{H}/_{\mathbf{S}}$ and some coefficient object (or “twisting object”) \mathbf{c} ; see also the exposition in [Sc12]. In fact in full generality (quantum) fields in slice toposes are equivalent to cocycles in (generalized and parameterized and possibly non-abelian and differential) *twisted cohomology*. The constructions on which the above discussion is built is given in some generality in [NSS12a].

In many examples of twisted (differential) structures/fields in slices the twist is constrained to have a certain factorization. For instance the twist of the (differential) String-structure in a heterotic background is constrained to be the (differential) second Chern-class of a (differential) $E_8 \times E_8$ -cocycle; or for instance the gauging of the 1d Chern-Simons fields on a knot in a 3d Chern-Simons theory bulk is constrained to be the restriction of the bulk gauge field, as discussed in section 1.2.15.1.5. Another example is the twist of the Chan-Paton bundles on D-branes, discussed below in section 1.2.12, which is constrained to be the restriction of the ambient Kalb-Ramond field to the D-brane. In all these cases the fields may be thought of as being maps in the slice topos that arise from maps in the *arrow topos* \mathbf{H}^{Δ^1} . A moduli stack here is a map of moduli stacks

$$\mathbf{Fields}_{\text{bulk+def}} : \mathbf{Fields}_{\text{def}} \longrightarrow \mathbf{Fields}_{\text{bulk}}$$

in \mathbf{H} ; and a domain on which such fields may be defined is an object $\Sigma_{\text{bulk}} \in \mathbf{H}$ equipped with a map (often, but not necessarily, an inclusion) $\Sigma_{\text{def}} \rightarrow \Sigma_{\text{bulk}}$, and a field configuration is a square of the form

$$\begin{array}{ccc} \Sigma_{\text{def}} & \xrightarrow{\phi_{\text{def}}} & \mathbf{Fields}_{\text{def}} \\ \downarrow & \swarrow \simeq & \downarrow \mathbf{Fields} \\ \Sigma_{\text{bulk}} & \xrightarrow{\phi_{\text{bulk}}} & \mathbf{Fields}_{\text{bulk}} \end{array}$$

in \mathbf{H} . If we now fix ϕ_{bulk} then $(\phi_{\text{bulk}})|_{\Sigma_{\text{def}}}$ serves as the twist, in the above sense, for ϕ_{def} . If $\mathbf{Fields}_{\text{def}}$ is trivial (the point/terminal object), then such a field is a cocycle in *relative cohomology*: a cocycle ϕ_{bulk} on Σ_{bulk} equipped with a trivialization $(\phi_{\text{bulk}})|_{\Sigma_{\text{def}}}$ of its restriction to Σ_{def} .

The fields in Chern-Simons theory with Wilson loops displayed in section 1.2.15.1.5 clearly constitute an example of this phenomenon. Another example is the field content of type II string theory on a 10-dimensional spacetime X with D-brane $Q \hookrightarrow X$, for which the above diagram reads

$$\begin{array}{ccc} Q & \longrightarrow & \mathbf{B}PU_{\text{conn}} \\ \downarrow & \swarrow \simeq & \downarrow \mathbf{d}d_{\text{conn}} \\ X & \xrightarrow{B} & \mathbf{B}^2U(1)_{\text{conn}} \end{array}$$

discussed further below in section 1.2.12. In 5.2.9 we discuss how the supergravity C-field over an 11-dimensional Hořava-Witten background with 10-dimensional boundary $X \hookrightarrow Y$ is similarly a relative cocycle, with the coefficients controlled, once more, by the extended Chern-Simons Lagrangian

$$\hat{\mathbf{c}} : \mathbf{B}(E_8 \times E_8)_{\text{conn}} \longrightarrow \mathbf{B}^3U(1)_{\text{conn}} \text{ ,}$$

now regarded in \mathbf{H}^{Δ^1} .

The following table lists some of main (classes of) examples. The left column displays a given extension of smooth ∞ -groups, to be regarded as a bundle of coefficients with typical ∞ -fiber shown on the far left. The middle column names the principal ∞ -bundles, or equivalently the nonabelian cohomology classes, that are classified by the base of these extensions. These are to be thought of as twisting cocycles. The right column names the corresponding twisted ∞ -bundles, or equivalently the corresponding twisted cohomology classes.

extension / ∞ -bundle of coefficients	twisting ∞ -bundle / twisting cohomology	twisted ∞ -bundle / twisted cohomology
$V \longrightarrow V//G$ $\downarrow \rho$ $\mathbf{B}G$	ρ -associated V - ∞ -bundle	section
$\mathrm{GL}(d)/O(d) \longrightarrow \mathbf{B}O(d)$ \downarrow $\mathbf{B}GL(d)$	tangent bundle	orthogonal structure / Riemannian geometry
$O(d)\backslash O(d,d)/O(d) \rightarrow \mathbf{B}(O(d) \times O(d))$ \downarrow $\mathbf{B}O(d,d)$	generalized tangent bundle	generalized (type II) Riemannian geometry
$\mathbf{B}U(n) \longrightarrow \mathbf{B}PU(n)$ $\downarrow \mathrm{dd}$ $\mathbf{B}^2U(1)$	circle 2-bundle / bundle gerbe	twisted vector bundle / bundle gerbe module
$\mathbf{B}^2U(1) \longrightarrow \mathbf{B}\mathrm{Aut}(\mathbf{B}U(1))$ \downarrow $\mathbf{B}\mathbb{Z}_2$	double cover	orientifold structure / Jandl bundle gerbe
$\mathbf{B}^2\ker(G) \longrightarrow \mathbf{B}\mathrm{Aut}(\mathbf{B}G)$ \downarrow $\mathbf{B}\mathrm{Out}(G)$	band (<i>lien</i>)	nonabelian (Giraud-Breen) G - ∞ -gerbe
$\mathbf{B}\mathrm{String} \longrightarrow \mathbf{B}\mathrm{Spin}$ $\downarrow \frac{1}{2}\mathbb{P}^1$ $\mathbf{B}^3U(1)$	circle 3-bundle / bundle 2-gerbe	twisted String 2-bundle
$Q \longrightarrow \mathbf{B}(\mathbb{T} \times \mathbb{T}^*)$ $\downarrow \langle c_1 \cup c_1 \rangle$ $\mathbf{B}^3U(1)$	circle 3-bundle / bundle 2-gerbe	twisted T-duality structure
$\mathbf{B}\mathrm{Fivebrane} \longrightarrow \mathbf{B}\mathrm{String}$ $\downarrow \frac{1}{6}\mathbb{P}^2$ $\mathbf{B}^7U(1)$	circle 7-bundle	twisted Fivebrane 6-bundle
$\mathfrak{b}\mathbf{B}^nU(1) \longrightarrow \mathbf{B}^nU(1)$ $\downarrow \mathrm{curv}$ $\mathfrak{b}_{\mathrm{dR}}\mathbf{B}^{n+1}U(1)$	curvature $(n+1)$ -form	circle n -bundle with connection

The following table lists smooth twisting ∞ -bundles \mathbf{c} that become *identities under geometric realization*, def. 4.3.24, (the last one on 15-coskeleta). This means that the twists are purely geometric, the underlying topological structure being untwisted.

universal twisting ∞ -bundle	twisted cohomology	relative twisted cohomology
$\mathbf{BO}(d)$ \downarrow $\mathbf{BGL}(d)$	Riemannian geometry, orthogonal structure	
$\mathbf{BO}(d) \times \mathbf{O}(d)$ \downarrow $\mathbf{BO}(d, d)$	type II NS-NS generalized geometry	
\mathbf{BH}_n \downarrow $\mathbf{BE}_{n(n)}$	U-duality geometry, exceptional generalized geometry	
$\mathbf{BPU}(\mathcal{H})$ $\downarrow \mathbf{dd}$ $\mathbf{B}^2U(1)$	twisted $U(n)$ -principal bundles	Freed-Witten anomaly cancellation on Spin^c -branes: B -field with twisted gauge bundles on D-branes
\mathbf{BE}_8 $\downarrow 2\mathbf{a}$ $\mathbf{B}^3U(1)$	twisted $\text{String}(E_8)$ -principal 2-bundles	M5-brane anomaly cancellation: C -field with twisted gauge 2-bundles on M5-branes

The following table lists smooth twisted ∞ -bundles that control various quantum anomaly cancellations in string theory.

universal twisting ∞ -bundle	twisted cohomology	relative twisted cohomology
\mathbf{BSO} $\downarrow \mathbf{w}_3$ $\mathbf{B}^2U(1)$	twisted Spin^c -structure	
$\mathbf{BPU}(\mathcal{H}) \times \mathbf{SO}$ $\downarrow \mathbf{dd} - \mathbf{w}_3$ $\mathbf{B}^2U(1)$		general Freed-Witten anomaly cancellation: B -field with twisted gauge bundles on D-branes
\mathbf{BSpin} $\downarrow \frac{1}{2}\mathbf{p}_1$ $\mathbf{B}^3U(1)$	twisted String -2-bundles; heterotic Green-Schwarz anomaly cancellation	
$\mathbf{BString}$ $\downarrow \frac{1}{6}\mathbf{p}_2$ $\mathbf{B}^7U(1)$	twisted Fivebrane-7-bundles; dual heterotic Green-Schwarz anomaly cancellation	

The following table lists twisting ∞ -bundles that encode geometric structure preserving higher supersymmetry.

universal twisting ∞ -bundle	twisted cohomology	relative twisted cohomology
$\mathbf{BU}(d, d)$ \downarrow $\mathbf{BO}(2d, 2d)$	generalized complex geometry	
$\mathbf{BSU}(3) \times \mathbf{SU}(3)$ \downarrow $\mathbf{BO}(6, 6)$	$d = 6, N = 2$ type II compactification	
$\mathbf{BSU}(7)$ \downarrow $\mathbf{BE}_{7(7)}$	$d = 7, N = 1$ 11d sugra compactification	

5.2.2 Sections of vector bundles – twisted 0-bundles

We discuss here for illustration purposes twisted ∞ -bundles in *lower* degree than traditionally considered, namely *twisted 0-bundles*. This degenerate case is in itself simple, but all the more does it serve to illustrate by familiar example the general notions of twisted ∞ -bundles.

So we consider coefficient ∞ -bundles such as

$$\begin{array}{ccc} \mathbb{C} & \longrightarrow & \mathbb{C} // U(1) \\ & & \downarrow \\ & & \mathbf{B}U(1) \end{array},$$

where

- $\mathbf{B}U(1)$ is the smooth moduli stack of smooth circle bundles;
- \mathbb{C} is the complex plane, regarded as a smooth manifold.

By 3.6.13 this corresponds equivalently to a representation of the Lie group $U(1)$ on \mathbb{C} , and this we take to be the canonical such representation. Accordingly, the above bundle is indeed the *universal complex line bundle* over the base space of the universal $U(1)$ -principal bundle.

It will be meaningful and useful to think of \mathbb{C} itself as a moduli ∞ -stack: it is the smooth *moduli 0-stack of complex 0-vector bundles*, where, therefore, a complex 0-vector bundle on a smooth space X is simply a smooth function $\in C^\infty(X, \mathbb{C})$. Accordingly, we should find that such 0-vector bundles can be twisted by a principal $U(1)$ -bundle and indeed, by feeding the above coefficient ∞ -bundle through the definition of twisted ∞ -bundles in 3.6.14, one finds, as we discuss below, that a *twisted 0-bundle* is a smooth section of the *associated line bundle*, hence, by local triviality of the line bundle, locally a complex-valued function, but globally twisted by the twisting circle bundle.

Let G be a Lie group, V a vector space and $\rho : V \times G \rightarrow V$ a smooth representation of G on V in the traditional sense. We discuss how this is an ∞ -group representation in the sense of def. 3.6.149.

Definition 5.2.1. Write

$$V // G := V \times G \begin{array}{c} \xrightarrow{p_1} \\ \xrightarrow{\rho} \end{array} V$$

for the *action groupoid* of ρ , the weak quotient of V by G , regarded as a smooth ∞ -groupoid $V // G \in \text{Smooth}\infty\text{Grpd}$.

Notice that this is equipped with a canonical morphism $V // G \rightarrow \mathbf{B}G$ and a canonical inclusion $V \rightarrow V // G$.

Proposition 5.2.2. *We have a fiber sequence*

$$V \rightarrow V // G \rightarrow \mathbf{B}G$$

in $\text{Smooth}\infty\text{Grpd}$.

Proof. One finds that in the canonical presentation by simplicial presheaves as in 4.4.2, the morphism $V // G_{\text{ch}} \rightarrow \mathbf{B}G_{\text{ch}}$ is a fibration in $[\text{CartSp}^{\text{op}}, \text{sSet}]_{\text{proj}}$. Therefore by prop. 2.3.13 the homotopy fiber is given by the ordinary fiber of this presentation. This ordinary fiber is V . \square

Remark 5.2.3. By remark 3.6.206 we may think of the fiber sequence

$$\begin{array}{ccc} V & \longrightarrow & V // G \\ \downarrow & & \downarrow \\ * & \longrightarrow & \mathbf{B}G \end{array}$$

as the vector bundle over the classifying stack $\mathbf{B}G$ which is ρ -associated to the universal G -principal bundle.

More formally, the next proposition shows that the ρ -associated bundles according to def. 3.6.206 are the ordinary associated vector bundles.

Proposition 5.2.4. *Let X be a smooth manifold and $P \rightarrow X$ be a smooth G -principal bundle. If $g : X \rightarrow \mathbf{BG}$ is a cocycle for P as in 4.4.7, then the ρ -associated vector bundle $P \times_G V \rightarrow X$ is equivalent to the homotopy pullback of $V//G \rightarrow \mathbf{BG}$ along g :*

$$\begin{array}{ccc} P \times_G V & \longrightarrow & V//G \\ \downarrow & & \downarrow \\ X & \xrightarrow{g} & \mathbf{BG} \end{array} .$$

Proof. By the discussion in 4.4.7 we may present g by a morphism in $[\mathbf{CartSp}^{\text{op}}, \mathbf{sSet}]_{\text{proj,loc}}$ of the form

$$\begin{array}{ccc} C(\{U_i\}) & \xrightarrow{g} & \mathbf{BG}_{\text{ch}} \\ \downarrow \simeq & & \\ X & & \end{array}$$

where $C(\{U_i\})$ is the Čech nerve of a good open cover of X . Since $V//G_{\text{ch}} \rightarrow \mathbf{BG}_{\text{ch}}$ is a fibration in $[\mathbf{CartSp}^{\text{op}}, \mathbf{sSet}]_{\text{proj}}$, by prop. 2.3.13 its ordinary pullback of simplicial presheaves along g presents the homotopy pullback in question. By inspection one finds that this is the Lie groupoid whose space of objects is $\coprod_i U_i \times V$ and which has a unique morphism from $(x \in U_i, \sigma_i(x) \in V)$ to $(x \in U_j, \sigma_j(x))$ if $\sigma_j(x) = \rho(g_{ij}(x))(\sigma_i(x))$.

Due to the uniqueness of morphisms, the evident projection from this Lie groupoid to the smooth manifold $P \times_G V$ which is the total space of the V -bundle ρ -associated to P is a weak equivalence in $[\mathbf{CartSp}^{\text{op}}, \mathbf{sSet}]_{\text{proj}}$, hence in $[\mathbf{CartSp}^{\text{op}}, \mathbf{sSet}]_{\text{proj,loc}}$. So $P \times_G V$ is indeed (one representative of) the homotopy pullback in question. \square

Since therefore all the information about ρ is encoded in the bundle $V \hookrightarrow V//G \rightarrow \mathbf{BG}$, we may identify that bundle with the action. Accordingly we write

$$\rho : V//G \rightarrow \mathbf{BG} .$$

Regarding ρ then as a universal local coefficient bundle, we obtain the corresponding twisted cohomology, 3.6.12, and twisted ∞ -bundles, 3.6.14. We show now that the general statement of prop. 3.6.217 on twisted cohomology in terms of sections of associated ∞ -bundles reduces for twists relative to ρ to the standard notion of spaces of sections.

Proposition 5.2.5. *Let $P \rightarrow X$ be a G -principal bundle over a smooth manifold X . Then the ∞ -groupoid of P -twisted cocycles relative to ρ , equivalently the ∞ -groupoid of P -twisted V -0-bundles is equivalent to the ordinary set of sections of the vector bundle $E \rightarrow X$ which is ρ -associated to P :*

$$\Gamma_X(E) \simeq \mathbf{H}_{/\mathbf{BG}}(g, \rho) .$$

Here $g : X \rightarrow \mathbf{BG}$ is the morphism classifying P .

Proof. The hom ∞ -groupoid of the slice ∞ -topos over \mathbf{BG} is the ∞ -pullback

$$\begin{array}{ccc} \mathbf{H}_{/\mathbf{BG}}(g, \rho) & \longrightarrow & \mathbf{H}(X, V//G) \\ \downarrow & & \downarrow \\ * & \xrightarrow{[g]} & \mathbf{H}(X, \mathbf{BG}) \end{array} .$$

Since the Čech nerve $C(\{U_i\})$ of the good cover $\{U_i \rightarrow X\}$ is a cofibrant representative of X in $[\mathbf{CartSp}^{\text{op}}, \mathbf{sSet}]_{\text{proj,loc}}$, and since \mathbf{BG}_{ch} and $V//G_{\text{ch}}$ from above are fibrant representatives of \mathbf{BG} and $V//G$, respectively, by the

properties of simplicial model categories the right vertical morphism here is presented by the morphism of Kan complexes.

$$[\mathbf{CartSp}^{\text{op}}, \mathbf{sSet}](C(\{U_i\}), V//G_{\text{ch}}) \rightarrow [\mathbf{CartSp}^{\text{op}}, \mathbf{sSet}](C(\{U_i\}), \mathbf{BG}_{\text{ch}}).$$

Moreover, since this is the simplicial hom out of a cofibrant object into a fibration, the properties of simplicial model categories imply that this morphism is indeed a Kan fibration. It follows with prop. 2.3.8 that the ordinary fiber of this morphism over $[g]$ is a Kan complex that presents the twisted cocycle ∞ -groupoid in question.

Since $V//G_{\text{ch}} \rightarrow \mathbf{BG}_{\text{ch}}$ is a faithful functor of groupoids, this fiber is a set, meaning a constant simplicial set. A $V//G_{\text{ch}}$ -valued cocycle is a collection of smooth functions $\{\sigma_i : U_i \rightarrow V\}_i$ and smooth functions $\{g_{ij} : U_{i,j} \rightarrow G\}_{i,j}$, satisfying the condition that on all U_{ij} we have $\sigma_j = \rho(g_{ij})(\sigma_i)$. This is a vertex in the fiber precisely if the second set of functions is that given by the cocycle g which classifies P . In this case this condition is precisely that which identifies the $\{\sigma_i\}_i$ as a section of the associated vector bundle, expressed in terms of the local trivialization that corresponds to g .

In conclusion, this shows that $\mathbf{H}_{/\mathbf{BG}}(g, \rho)$ is an ∞ -groupoid equivalent to set of sections of the vector bundle ρ -associated to P . \square

5.2.3 Sections of 2-bundles – twisted vector bundles and twisted K-classes

We construct now a coefficient ∞ -bundle of the form

$$\begin{array}{ccc} \mathbf{BU} & \longrightarrow & (\mathbf{BU})//\mathbf{BU}(1) \\ & & \downarrow \text{dd} \\ & & \mathbf{B}^2U(1) \end{array},$$

where

- $\mathbf{B}^2U(1)$ is the smooth moduli 2-stack for smooth circle 2-bundles / bundle gerbes;
- $\mathbf{BU} = \varinjlim_n \mathbf{BU}(n)$ is the inductive ∞ -limit over the smooth moduli stacks of smooth unitary rank- n vector bundles (equivalently: $U(n)$ -principal bundles).

Equivalently, this is a smooth ∞ -action of the smooth circle 2-group $\mathbf{BU}(1)$ on the smooth ∞ -stack \mathbf{BU} .

This may be thought of as the canonical 2-representation of the circle 2-group $\mathbf{BU}(1)$, def. 4.3.48, being the higher analogue to the canonical representation of the circle group $U(1)$ on the complex plane \mathbb{C} , discussed above in 5.2.2.

We show that the notion of twisted cohomology induced by this local coefficient bundle according to 3.6.12 is reduced *twisted K-theory* and that the notion of twisted ∞ -bundles induced by it according to 3.6.14 are ordinary *twisted vector bundles* also known as *bundle gerbe modules*. (See for instance chapter 24 of [May99] for basics of K-theory that we need here, and see for instance [CBMMS02] for a discussion of twisted K-theory in terms of twisted bundles.)

This not only shows how the traditional notion of twisted K-theory is reproduced from the perspective of cohomology in an ∞ -topos. It also refines the traditional constructions to the smooth context. Notice that there is a slight clash of terminology, as traditionally the term *smooth K-theory* is often used synonymously with *differential K-theory*. However, there is a geometric refinement in between bare (twisted) K-classes and differential (twisted) K-classes, namely smooth cocycle spaces of smooth (twisted) vector bundles and *smooth* gauge transformations between them. This is the smooth refinement of the situation that we find here, by regarding (twisted) K-theory as (twisted) cohomology internal to the ∞ -topos $\text{Smooth}\infty\text{Grpd}$.

The construction of the traditional topological classifying space for reduced K^0 proceeds as follows. For $n \in \mathbb{N}$, let $BU(n)$ be the classifying space of the unitary group in complex dimension n . The inclusion of

groups $U(n) \rightarrow U(n+1)$ induced by the inclusion $\mathbb{C}^n \rightarrow \mathbb{C}^{n+1}$ by extension by 0 in the, say, last coordinate gives an inductive system of topological spaces

$$* \longrightarrow \cdots BU(n) \longrightarrow BU(n+1) \longrightarrow \cdots .$$

Definition 5.2.6. Write

$$BU := \lim_{\rightarrow n} BU(n)$$

for the homotopy colimit in $\text{Top}_{\text{Quillen}}$.

Notice that by prop. 4.4.19 and prop. 4.3.30 we have, for each $n \in \mathbb{N}$, a smooth refinement of $BU(n) \in \text{Top} \simeq \infty\text{Grpd}$ to a smooth moduli stack $\mathbf{BU}(n) \in \text{Smooth}\infty\text{Grpd}$. This refines the set $[X, BU(n)]$ of equivalence classes of rank- n unitary vector bundles to the groupoid $\mathbf{H}(X, \mathbf{BU}(n))$ of unitary bundles and smooth gauge transformations between them.

We therefore consider now similarly a smooth refinement to moduli ∞ -stacks of the inductive limit BU .

Definition 5.2.7. Write

$$\mathbf{BU} := \lim_{\rightarrow n} \mathbf{BU}(n)$$

for the ∞ -colimit in $\text{Smooth}\infty\text{Grpd}$ over the smooth moduli stacks of smooth $U(n)$ -principal bundles.

Proposition 5.2.8. *The canonical morphism*

$$\lim_{\rightarrow n} \mathbf{BU}(n) \rightarrow \mathbf{B} \lim_{\rightarrow n} U(n)$$

is an equivalence in $\text{Smooth}\infty\text{Grpd}$.

Proof. Write $\mathbf{BU}(n)_{\text{ch}} := N(U(n) \rightrightarrows *) \in [\text{CartSp}^{\text{op}}, \text{sSet}]$ for the standard presentation of the delooping, prop. 4.4.19. Observe then that the diagram $n \mapsto \mathbf{BU}(n)_{\text{ch}}$ is cofibrant when regarded as an object of $[(\mathbb{N}, \leq), [\text{CartSp}^{\text{op}}, \text{sSet}]_{\text{inj,loc}}]_{\text{proj}}$, because, by example 2.3.16, a cotower is projectively cofibrant if it consists of monomorphisms and if the first object, and hence all objects, are cofibrant. Therefore the ∞ -colimit is presented by the ordinary colimit over this diagram. Since this is a filtered colimit, it commutes with finite limits of simplicial presheaves:

$$\begin{aligned} \lim_{\rightarrow n} \mathbf{BU}(n)_{\text{ch}} &= \lim_{\rightarrow n} N(U(n) \rightrightarrows *) \\ &= N(\lim_{\rightarrow n} U(n) \rightrightarrows *) \\ &= (\mathbf{B} \lim_{\rightarrow n} U(n))_{\text{ch}} . \end{aligned}$$

□

Proposition 5.2.9. *The smooth object \mathbf{BU} is a smooth refinement of the topological space BU in that it reproduces the latter under geometric realization, 4.3.4.1:*

$$|\mathbf{BU}| \simeq BU .$$

Proof. By prop. 4.3.29 for every $n \in \mathbb{N}$ we have

$$|\mathbf{BU}(n)| \simeq BU(n) .$$

Moreover, by the discussion at 4.3.4.1, up to the equivalence $\text{Top} \simeq \infty\text{Grpd}$ the geometric realization is given by applying the functor $\Pi : \text{Smooth}\infty\text{Grpd} \rightarrow \infty\text{Grpd}$. That is a left ∞ -adjoint and hence preserves ∞ -colimits:

$$\begin{aligned} |\mathbf{BU}| &\simeq \left| \lim_{\rightarrow_n} \mathbf{BU}(n) \right| \\ &\simeq \lim_{\rightarrow_n} |\mathbf{BU}(n)| \\ &\simeq \lim_{\rightarrow_n} \mathbf{BU}(n) \\ &\simeq \mathbf{BU}. \end{aligned}$$

□

Corollary 5.2.10. *For $X \in \text{SmthMfd} \hookrightarrow \text{Smooth}\infty\text{Grpd}$, the intrinsic cohomology of X with coefficients in the smooth stack \mathbf{BU} is the reduced K-theory $\tilde{K}(X)$:*

$$H_{\text{smooth}}^1(X, U) := \pi_0 \mathbf{H}(X, \mathbf{BU}) \simeq \tilde{K}(X).$$

Proof. By prop. 4.3.39 the set $\pi_0 \mathbf{H}(X, \mathbf{BU})$ is the Čech cohomology of X with coefficients in the stable unitary group U . By classification theory (as discussed in [RoSt12]) this is isomorphic to the set of homotopy classes of maps $\pi_0 \text{Top}(X, \mathbf{BU})$ into the classifying space \mathbf{BU} for reduced K-theory. □

Proposition 5.2.11. *Let X be a compact smooth manifold. Then*

$$\mathbf{H}(X, \mathbf{BU}) \simeq \lim_{\rightarrow_n} \mathbf{H}(X, \mathbf{BU}(n))$$

and

$$\mathbf{H}(X, \mathbf{BPU}) \simeq \lim_{\rightarrow_n} \mathbf{H}(X, \mathbf{BPU}(n)).$$

Proof. That X is a compact manifold means by def. 3.6.57 that it is a *representably compact object* in the site SmthMfd . Since X is in particular paracompact, prop. 3.6.63 says that it is also a *representably paracompact object* in the site, def. 3.6.62. With this the statement is given by prop. 3.6.64. □

We now discuss twisted bundles induced by the local coefficient bundles $\mathbf{dd}_n : \mathbf{BPU}(n) \rightarrow \mathbf{B}^2U(1)$ for every $n \in \mathbb{N}$. This is immediately generalized to general central extensions.

So let $U(1) \rightarrow \hat{G} \rightarrow G$ be any $U(1)$ -central extension of a Lie group G and let $\mathbf{c} : \mathbf{BG} \rightarrow \mathbf{B}^2U(1)$ the classifying morphism of moduli 2-stacks, according to prop. 3.6.148, sitting in the fiber sequence

$$\begin{array}{ccc} \mathbf{B}\hat{G} & \longrightarrow & \mathbf{B}G \\ & & \downarrow \mathbf{c} \\ & & \mathbf{B}^2U(1) \end{array}$$

Proposition 5.2.12. *Let $U(1) \rightarrow \hat{G} \rightarrow G$ be a group extension of Lie groups. Let $X \in \text{SmoothMfd} \hookrightarrow \text{Smooth}\infty\text{Grpd}$ be a smooth manifold with differentiably good open cover $\{U_i \rightarrow X\}$.*

1. *Relative to this data every twisting cocycle $[\alpha] \in H_{\text{Smooth}}^2(X, U(1))$ is a Čech-cohomology representative given by a collection of functions*

$$\{\alpha_{ijk} : U_i \cap U_j \cap U_k \rightarrow U(1)\}$$

satisfying on every quadruple intersection the equation

$$\alpha_{ijk}\alpha_{ikl} = \alpha_{jkl}\alpha_{ijl}.$$

2. In terms of this cocycle data, the twisted cohomology $H_{[\alpha]}^1(X, \hat{G})$ is given by equivalence classes of cocycles consisting of

(a) collections of functions

$$\{g_{ij} : U_i \cap U_j \rightarrow \hat{G}\}$$

subject to the condition that on each triple overlap the equation

$$g_{ij}g_{jk} = g_{ik} \cdot \alpha_{ijk}$$

holds, where on the right we are injecting α_{ijk} via $U(1) \rightarrow \hat{G}$ into \hat{G} and then form the product there;

(b) subject to the equivalence relation that identifies two such collections of cocycle data $\{g_{ij}\}$ and $\{g'_{ij}\}$ if there exists functions

$$\{h_i : U_i \rightarrow \hat{G}\}$$

and

$$\{\beta_{ij} : U_i \cap U_j \rightarrow \hat{U}(1)\}$$

such that

$$\beta_{ij}\beta_{jk} = \beta_{ik}$$

and

$$g'_{ij} = h_i^{-1} \cdot g_{ij} \cdot h_j \cdot \beta_{ij}.$$

Proof. We pass to the standard presentation of $\text{Smooth}\infty\text{Grpd}$ by the projective local model structure on simplicial presheaves over the site $\text{CartSp}_{\text{smooth}}$. There we compute the defining ∞ -pullback by a homotopy pullback, according to remark 2.3.14.

Write $\mathbf{B}\hat{G}_{\text{ch}}, \mathbf{B}^2U(1)_{\text{ch}} \in [\text{CartSp}^{\text{op}}, \text{sSet}]$ etc. for the standard models of the abstract objects of these names by simplicial presheaves, as discussed in 4.4.2. Write accordingly $\mathbf{B}(U(1) \rightarrow \hat{G})_{\text{ch}}$ for the delooping of the crossed module 2-group associated to the central extension $\hat{G} \rightarrow G$.

By prop. 3.6.148, in terms of this the characteristic class \mathbf{c} is represented by the ∞ -anafunctor

$$\begin{array}{ccc} \mathbf{B}(U(1) \rightarrow \hat{G})_{\text{ch}} & \xrightarrow{\mathbf{c}} & \mathbf{B}(U(1) \rightarrow 1)_{\text{ch}} = \mathbf{B}^2U(1)_{\text{ch}} , \\ \downarrow \simeq & & \\ \mathbf{B}G_{\text{ch}} & & \end{array}$$

where the top horizontal morphism is the evident projection onto the $U(1)$ -labels. Moreover, the Čech nerve of the good open cover $\{U_i \rightarrow X\}$ forms a cofibrant resolution

$$\emptyset \hookrightarrow C(\{U_i\}) \xrightarrow{\cong} X$$

and so α is presented by an ∞ -anafunctor

$$\begin{array}{ccc} C(\{U_i\}) & \xrightarrow{\alpha} & \mathbf{B}^2U(1)_c . \\ \downarrow \simeq & & \\ X & & \end{array}$$

Using that $[\text{CartSp}^{\text{op}}, \text{sSet}]_{\text{proj}}$ is a simplicial model category this means in conclusion that the homotopy pullback in question is given by the ordinary pullback of simplicial sets

$$\begin{array}{ccc} \mathbf{H}_{[\alpha]}^1(X, \hat{G}) & \xrightarrow{\quad} & * \\ \downarrow & & \downarrow \alpha \\ [\text{CartSp}^{\text{op}}, \text{sSet}](C(\{U_i\}), \mathbf{B}(U(1) \rightarrow \hat{G})_c) & \xrightarrow{\mathbf{c}^*} & [\text{CartSp}^{\text{op}}, \text{sSet}](C(\{U_i\}), \mathbf{B}^2U(1)_c) \end{array}$$

An object of the resulting simplicial set is then seen to be a simplicial map $g : C(\{U_i\}) \rightarrow \mathbf{B}(U(1) \rightarrow \hat{G})_c$ that assigns

$$g : \begin{array}{ccc} & (x, j) & \\ \nearrow & & \searrow \\ (x, i) & \xrightarrow{\quad} & (x, k) \end{array} \quad \mapsto \quad \begin{array}{ccc} & * & \\ \nearrow^{g_{ij}(x)} & & \searrow^{g_{jk}(x)} \\ * & \xrightarrow{g_{ik}(x)} & * \end{array}$$

such that projection out along $\mathbf{B}(U(1) \rightarrow \hat{G})_c \rightarrow \mathbf{B}(U(1) \rightarrow 1)_c = \mathbf{B}^2U(1)_c$ produces α .

Similarly for the morphisms. Writing out what these diagrams in $\mathbf{B}(U(1) \rightarrow \hat{G})_c$ mean in equations, one finds the formulas claimed above. \square

5.2.4 Reduction of structure groups

We discuss the traditional notion of *reduction* of a structure group in terms of twisted differential nonabelian cohomology. This perspective turns out to embed this standard notion seamlessly into more general notion of twisted differential structures, def. 3.9.61. Conversely, this perspective shows that the general notion of twisted differential structures may be thought of as a generalization of the classical notion of reduction of structure groups from principal bundles to principal ∞ -bundles.

Let G be a Lie group and let $K \hookrightarrow G$ be a Lie subgroup. Write

$$\mathbf{c} : \mathbf{B}K \rightarrow \mathbf{B}G$$

for the induced morphism of smooth moduli stacks of smooth principal bundles, according to prop. 4.4.19.

Observation 5.2.13. The action groupoid $G//K$, def. 1.2.70, is 0-truncated, hence the canonical morphism to the smooth manifold quotient

$$G//K \xrightarrow{\cong} G/K$$

is an equivalence in $\text{Smooth}\infty\text{Grpd}$.

We have a fiber sequence of smooth stacks

$$G/K \rightarrow \mathbf{B}K \rightarrow \mathbf{B}G.$$

This is presented by the evident sequence of simplicial presheaves

$$G//K \rightarrow *//K \rightarrow *//G.$$

Proof. The equivalence follows because the action of a subgroup is free. The fiber sequence may be computed for instance with the factorization lemma, prop. 2.3.9. \square

In applications, an important class of examples is the following.

Observation 5.2.14. For G a connected Lie group, let $K \hookrightarrow G$ be the inclusion of its maximal compact subgroup. Then $\mathbf{c} : \mathbf{B}K \rightarrow \mathbf{B}G$ is a Π -equivalence, def. 3.8.23 (hence becomes an equivalence under geometric realization, def. 3.8.2). Therefore, while the groupoids of K, G -principal bundles are different and

$$\mathbf{H}(X, \mathbf{B}K) \rightarrow \mathbf{H}(X, \mathbf{B}G)$$

is not an equivalence, unless G is itself already compact, it does induce an isomorphism on connected components (nonabelian cohomology sets)

$$H^1(X, K) \xrightarrow{\cong} H^1(X, G).$$

In the following discussion this difference between the classifying spaces $BG \simeq \Pi(\mathbf{B}G) \simeq \Pi(\mathbf{B}K) \simeq BK$ and their smooth refinements is crucial.

Theorem 4.3.47 in the present case says that $\Pi(G/K) \simeq *$ contractible. This recovers the classical statement that, as a topological space, G is a product of its maximal compact subgroup with a contractible space.

Proof. It is a classical fact that the maximal compact subgroup inclusion $K \hookrightarrow G$ is a homotopy equivalence on the underlying topological spaces. The statement then follows by prop. 4.3.31. \square

Given a subgroup inclusion $K \hookrightarrow G$ and a G -principal bundle P , a standard question is whether the structure group of P may be reduced to K .

Definition 5.2.15. Let $K \hookrightarrow G$ be an inclusion of Lie groups and let $X \in \text{Smooth}\infty\text{Grpd}$ be any object (for instance a smooth manifold). Let $g : X \rightarrow \mathbf{B}G$ be a smooth classifying morphism for a G -principal bundle $P \rightarrow X$.

A choice of *reduction of the structure group* of G along $K \hookrightarrow G$ (or K -reduction for short) is a choice of lift g_{red} and a choice of homotopy (gauge transformation) η of smooth stacks in the diagram

$$\begin{array}{ccc} & & \mathbf{B}K \\ & \nearrow^{g_{\text{red}}} & \downarrow \mathbf{c} \\ X & \xrightarrow{g} & \mathbf{B}G \end{array} \quad .$$

(Note: A dashed arrow labeled η points from $\mathbf{B}G$ to $\mathbf{B}K$, and a double arrow labeled η is between $\mathbf{B}G$ and $\mathbf{B}K$.)

For (g_{red}, η) and (g'_{red}, η') two K -reductions of P , an *isomorphism* of K -reductions from the first to the second is a natural transformation of morphisms of smooth stacks

$$\begin{array}{ccc} & \xrightarrow{g_{\text{red}}} & \mathbf{B}K \\ X & \Downarrow \rho & \\ & \xrightarrow{g'_{\text{red}}} & \mathbf{B}K \end{array} \quad ,$$

hence a choice of gauge transformation between the corresponding K -principal bundles, such that

$$\begin{array}{ccc} \xrightarrow{g_{\text{red}}} & \mathbf{B}K & \\ \uparrow \rho & \nearrow^{g_{\text{red}}} & \downarrow \mathbf{c} \\ X & \xrightarrow{g} & \mathbf{B}G \end{array} \quad = \quad \begin{array}{ccc} \xrightarrow{g_{\text{red}}} & \mathbf{B}K & \\ \uparrow \eta & \nearrow^{g_{\text{red}}} & \downarrow \mathbf{c} \\ X & \xrightarrow{g} & \mathbf{B}G \end{array} \quad .$$

With the obvious notion of composition of such isomorphisms, this defines a *groupoid of K -reductions* of P .

Remark 5.2.16. The crucial information is in the *choice* of the smooth transformation η . Notably in the case that $K \hookrightarrow G$ is the inclusion of a maximal compact subgroup as in observation 5.2.14 the underlying reduction problem after geometric realization in the homotopy theory of topological spaces is trivial: all bundles involved in the above are equivalent. The important information in η is about *how* they are chosen to be equivalent, and smoothly so.

Below in 5.2.4.1 we see that in the case that $P = TX$ is the tangent bundle of a manifold, η is identified with a choice of *vielbein* or *soldering form*.

Comparison with the discussion in 3.6.12 reveals that therefore structure group reduction is a topic in *twisted nonabelian cohomology*. In particular, we may apply def. 3.9.61 to form the groupoid of all choices of reductions.

Proposition 5.2.17. For $g : X \rightarrow \mathbf{B}G$ (the cocycle for) a G -principal bundle $P \rightarrow X$, the groupoid of K -reductions of P according to def. 5.2.15 is the groupoid of $[g]$ -twisted \mathbf{c} -structures, def. 3.9.61, hence the homotopy pullback $\mathbf{cStruc}_{[g]}(X)$ in

$$\begin{array}{ccc} \mathbf{cStruc}_{[g]}(X) & \longrightarrow & * \\ \downarrow & & \downarrow g \\ \mathbf{H}(X, \mathbf{B}K) & \xrightarrow{\mathbf{H}(X, \mathbf{c})} & \mathbf{H}(X, \mathbf{B}G) \end{array} ,$$

where

$$\mathbf{c} : \mathbf{B}K \rightarrow \mathbf{B}G$$

is the induced morphism of smooth moduli stacks.

Proof. Using that $\mathbf{B}K$ and $\mathbf{B}G$ are 1-truncated objects in $\mathbf{H} := \text{Smooth}\infty\text{Grpd}$, by construction, one sees that the groupoid defined in def. 5.2.15 is equivalently the hom-groupoid $\mathbf{H}_{/\mathbf{B}G}(g, \mathbf{c})$ in the slice ∞ -topos $\mathbf{H}_{/\mathbf{B}G}$. Using this, the statement is a special case of prop. 3.6.218. \square

Remark 5.2.18. By observation 5.2.13 we may equivalently speak of $\mathbf{cStruc}_g(X)$ as the *groupoid of twisted $G//K$ -structures* on X (where the latter is given by a corresponding groupoid-principal bundle).

If we think, according to remark 5.2.16, of a choice of K -reduction as a choice of *vielbein* or *soldering form*, then this says that *locally* their moduli space is the cose G/K (while globally there may be a twist).

The morphism \mathbf{c} as above always has a canonical differential refinement

$$\hat{\mathbf{c}} : \mathbf{B}K_{\text{conn}} \rightarrow \mathbf{B}G_{\text{conn}}$$

given by prop. 1.2.107. Accordingly, we may also apply def. 3.9.62 to the case of structure group reduction.

Definition 5.2.19. For $K \rightarrow G$ a Lie subgroup inclusion, and for $\nabla : X \rightarrow \mathbf{B}G_{\text{conn}}$ (a cocycle for) a G -principal bundle with connection on X , we say the *groupoid of K -reductions* of ∇ is the groupoid $\hat{\mathbf{c}}\text{Struc}_{[\nabla]}(X)$ of *twisted differential $\hat{\mathbf{c}}$ -structures*, given as the homotopy pullback

$$\begin{array}{ccc} \hat{\mathbf{c}}\text{Struc}_{[\nabla]}(X) & \longrightarrow & * \\ \downarrow & & \downarrow \nabla \\ \mathbf{H}(X, \mathbf{B}K_{\text{conn}}) & \xrightarrow{\mathbf{H}(X, \hat{\mathbf{c}})} & \mathbf{H}(X, \mathbf{B}G_{\text{conn}}) \end{array} .$$

However, here the differential refinement does not change the homotopy type of the twisted cohomology

Proposition 5.2.20. For P a G -principal bundle with connection ∇ the groupoid of K -reductions of ∇ is equivalent to the groupoid of K -reductions of just P

$$\hat{\mathbf{c}}\text{Struc}_{[\nabla]}(X) \simeq \mathbf{cStruc}_{[P]}(X) .$$

Remark 5.2.21. This degeneracy of notions does not hold for twisted structures controlled by higher groups. That it holds in the special case of ordinary K -reductions is an incarnation of a classical fact in differential geometry: as we will see in 5.2.4.1 below, for reductions of tangent bundle structure it comes down to the fact that for every choice of Riemannian metric and torsion there is a unique metric-compatible connection with that torsion. Prop. 5.2.20 may be understood as stating this in the fullest generality of G -principal bundles for G a Lie group.

5.2.4.1 Orthogonal/Riemannian structure For X a smooth manifold, we discuss the traditional notion of *Riemannian* structure or equivalently of *orthogonal structure* on X as a special case of \mathbf{c} -twisted cohomology for suitable \mathbf{c} . This perspective on ordinary Riemannian geometry proves to be a useful starting point for generalizations.

Let X be a smooth manifold of dimension d . Its tangent bundle TX is associated to an essentially canonical $\mathrm{GL}(d)$ -principal bundle. We write

$$TX : X \rightarrow \mathbf{BGL}(d)$$

for the corresponding classifying morphism, where $\mathbf{BGL}(d)$ is the smooth moduli stack of smooth $\mathrm{GL}(d)$ -principal bundles.

Consider the defining inclusion of Lie groups

$$\mathrm{O}(d) \hookrightarrow \mathrm{GL}(d)$$

and the induced morphism of the corresponding moduli stacks

$$\mathbf{orth} : \mathbf{BO}(d) \rightarrow \mathbf{BGL}(d).$$

The general observation 5.2.13 here reads

Observation 5.2.22. The homotopy fiber of \mathbf{orth} is the quotient manifold $\mathrm{GL}(d)/\mathrm{O}(d)$. We have a fiber sequence of smooth stacks

$$\mathrm{GL}(d)/\mathrm{O}(d) \longrightarrow \mathbf{BO}(d) \xrightarrow{\mathbf{orth}} \mathbf{BGL}(d).$$

Notice that $\mathrm{O}(d) \hookrightarrow \mathrm{GL}(d)$ is a maximal compact subgroup inclusion, so that observation 5.2.14 applies. Definition 5.2.17 now becomes

Definition 5.2.23. Write $\mathbf{orthStruc}_{TX}$ for the groupoid of TX -twisted \mathbf{orth} -structures on X , hence the homotopy pullback in

$$\begin{array}{ccc} \mathbf{orthStruc}(X) & \longrightarrow & * \\ \downarrow & \swarrow \simeq & \downarrow TX \\ \mathbf{H}(X, \mathbf{BO}(d)) & \xrightarrow{\mathbf{H}(X, \mathbf{orth})} & \mathbf{H}(X, \mathbf{BGL}(d)) \end{array} .$$

Proposition 5.2.24. *The groupoid $\mathbf{orthStruc}_{TX}(X)$ is naturally identified with the groupoid of choices of vielbein fields (soldering forms) on TX .*

Proof. Let $\{U_i \rightarrow X\}$ be any good open cover of X by coordinate patches $\mathbb{R}^d \simeq U_i$. Let $C(\{U_i\})$ be the corresponding Čech groupoid. There is then a canonical span of simplicial presheaves

$$\begin{array}{ccc} C(\{U_i\}) & \xrightarrow{TX_{\mathrm{ch}}} & \mathbf{BGL}(d)_{\mathrm{ch}} \\ \downarrow \simeq & & \\ X & & \end{array} .$$

presenting TX . Moreover, every morphism $g : X \rightarrow \mathbf{BO}(d)$ has a presentation by a similar span g_{ch} with values in $\mathbf{BO}(d)$.

An object in $\mathbf{orthStruc}_{TX}(X)$ is

1. a cocycle g_{ch} for an $\mathrm{O}(d)$ -principal bundle as above;
2. over each U_i an element $e|_{U_i} \in C^\infty(U_i, \mathrm{GL}(d))$

such that e is compatible, on double overlaps, with the left $O(d)$ -action by the transition functions g_{ch} and the right $GL(d)$ -action by the transition functions TX_{ch} .

A morphism $e \rightarrow e'$ in $\mathbf{orthStruc}_{TX}(X)$ is a gauge transformation $g_{\text{ch}} \rightarrow g'_{\text{ch}}$ of $O(d)$ -principal bundles whose left action takes e to e' .

From this it is clear that

$$e = \{e^a_{\mu}\}_{a,\mu \in \{1, \dots, d\}}$$

is a choice of vielbein. □

There is an evident differential refinement of \mathbf{orth}

$$\hat{\mathbf{orth}} : \mathbf{BO}(d)_{\text{conn}} \rightarrow \mathbf{BGL}(d)_{\text{conn}} .$$

Definition 5.2.25. Let $\text{Conn}TX \rightarrow \mathbf{H}(X, \mathbf{BGL}(d)_{\text{conn}})$ be the left vertical morphism in the homotopy pullback

$$\begin{array}{ccc} \text{Conn}TX & \longrightarrow & * \\ \downarrow & & \downarrow TX \\ \mathbf{H}(X, \mathbf{BGL}(d)_{\text{conn}}) & \longrightarrow & \mathbf{H}(X, \mathbf{BGL}(d)) \end{array} ,$$

where the bottom map is the morphism that forgets the connection.

This morphism may be thought of as the inclusion of connections on the tangent bundle into the groupoid of all $GL(d)$ -principal connections.

Proposition 5.2.26. *The homotopy pullback in*

$$\begin{array}{ccc} \hat{\mathbf{orth}}\text{Struc}_{TX, \text{conn}}(X) & \longrightarrow & \text{Conn}TX \\ \downarrow & & \downarrow \\ \mathbf{H}(X, \mathbf{BO}(d)_{\text{conn}}) & \xrightarrow{\mathbf{H}(X, \hat{\mathbf{orth}})} & \mathbf{H}(X, \mathbf{BGL}(d)_{\text{conn}}) \end{array}$$

or equivalently that in

$$\begin{array}{ccc} \hat{\mathbf{orth}}\text{Struc}_{TX, \text{conn}}(X) & \longrightarrow & * \\ \downarrow & & \downarrow TX \\ \mathbf{H}(X, \mathbf{BO}(d)_{\text{conn}}) & \longrightarrow & \mathbf{H}(X, \mathbf{BGL}(d)) \end{array}$$

is equivalent to the set of pairs of Riemannian metrics on X and correspondingly metric-compatible connections on TX .

Proof. The two pullbacks are equivalent by def. 5.2.25 and the pasting law, prop. 2.3.2.

Consider the first version. As in the proof of prop. 5.2.24 an object in the groupoid has an underlying choice of vielbein e . This now being a morphism of bundles with connection, it related, locally on each U_i , the given connection form Γ on TX with a connection form ω on the $O(d)$ -principal bundle, via

$$\omega^a_b = e^a_{\alpha} \Gamma^{\alpha}_{\beta} (e^{-1})^b_{\beta} + e^a_{\alpha} d_{\text{dR}}(e^{-1})^b_{\beta} .$$

But since ω is by definition an orthogonal connection, by this isomorphism Γ is a metric-compatible connection. □

5.2.4.2 Type II NS-NS generalized geometry The target space geometry for type II superstrings in the NS-NS sector is naturally encoded by a variant of “generalized complex geometry” with metric structure, discussed for instance in [GMPW08]. We discuss here how this *type II NS-NS generalized geometry* is a special case of twisted \mathfrak{c} -structures as in 5.2.4.

Definition 5.2.27. Consider the Lie group inclusion

$$\mathrm{O}(d) \times \mathrm{O}(d) \rightarrow \mathrm{O}(d, d)$$

of those orthogonal transformations, that preserve the positive definite part or the negative definite part of the bilinear form of signature (d, d) , respectively.

If $\mathrm{O}(d, d)$ is presented as the group of $2d \times 2d$ -matrices that preserve the bilinear form given by the $2d \times 2d$ -matrix

$$\eta := \begin{pmatrix} 0 & \mathrm{id}_d \\ \mathrm{id}_d & 0 \end{pmatrix}$$

then this inclusion sends a pair (A_+, A_-) of orthogonal $n \times n$ -matrices to the matrix

$$(A_+, A_-) \mapsto \frac{1}{\sqrt{2}} \begin{pmatrix} A_+ + A_- & A_+ - A_- \\ A_+ - A_- & A_+ + A_- \end{pmatrix}.$$

The inclusion of Lie groups induces the corresponding morphism of smooth moduli stacks of principal bundles

$$\mathbf{TypeII} : \mathbf{B}(\mathrm{O}(d) \times \mathrm{O}(d)) \rightarrow \mathbf{BO}(d, d).$$

Observation 5.2.13 here becomes

Observation 5.2.28. There is a fiber sequence of smooth stacks

$$\mathrm{O}(d, d)/(\mathrm{O}(d) \times \mathrm{O}(d)) \longrightarrow \mathbf{B}(\mathrm{O}(d) \times \mathrm{O}(d)) \xrightarrow{\mathbf{TypeII}} \mathbf{BO}(d, d) .$$

Definition 5.2.29. There is a canonical embedding

$$\mathrm{GL}(d) \hookrightarrow \mathrm{O}(d, d).$$

In the above matrix presentation this is given by sending

$$a \mapsto \begin{pmatrix} a & 0 \\ 0 & a^{-T} \end{pmatrix},$$

where in the bottom right corner we have the transpose of the inverse matrix of the invertible matrix a .

Observation 5.2.30. We have a homotopy pullback of smooth stacks

$$\begin{array}{ccc} \mathrm{GL}(d) \backslash \backslash \mathrm{O}(d, d) // (\mathrm{O}(d) \times \mathrm{O}(d)) & \longrightarrow & \mathbf{BGL}(d) \\ \downarrow & & \downarrow \\ \mathbf{B}(\mathrm{O}(d) \times \mathrm{O}(d)) & \longrightarrow & \mathbf{BO}(d, d) \end{array} .$$

Definition 5.2.31. Under inclusion def. 5.2.27 the tangent bundle of a d -dimensional manifold X defines an $\mathrm{O}(d, d)$ -cocycle

$$TX \otimes T^*X : X \xrightarrow{TX} \mathbf{BGL}(d) \longrightarrow \mathbf{BO}(d, d) .$$

The vector bundle canonically associated to this composite cocycles may canonically be identified with the tensor product vector bundle $TX \otimes T^*X$, and so we will refer to this cocycle by these symbols, as indicated.

Therefore we may canonically consider the groupoid of $TX \otimes T^*X$ -twisted **TypeII**-structures, according to def. 5.2.17:

Definition 5.2.32. Write $\mathbf{TypeII} \text{Struc}_{TX \otimes T^*X}(X)$ for the homotopy pullback

$$\begin{array}{ccc} \mathbf{TypeII} \text{Struc}_{TX \otimes T^*X}(X) & \longrightarrow & * \\ \downarrow & & \downarrow_{TX \otimes T^*X} \\ \mathbf{H}(X, \mathbf{B}(O(d) \times O(d))) & \xrightarrow{\mathbf{H}(X, \mathbf{TypeII})} & \mathbf{H}(X, \mathbf{B}O(d, d)) \end{array}$$

Proposition 5.2.33. *The groupoid $\mathbf{TypeII} \text{Struc}_{TX \otimes T^*X}(X)$ is that of “generalized vielbein fields” on X , as considered for instance around equation (2.24) of [GMPW08] (there only locally, but the globalization is evident).*

In particular, its set of equivalence classes is the set of type-II generalized geometry structures on X .

Proof. This is directly analogous to the proof of prop. 5.2.24. \square

Over a local patch $\mathbb{R}^d \simeq U_i \hookrightarrow X$, the most general such generalized vielbein (hence the most general $O(d, d)$ -valued function) may be parameterized as

$$E = \frac{1}{2} \begin{pmatrix} (e_+ + e_-) + (e_+^{-T} - e_-^{-T})B & (e_+^{-T} - e_-^{-T}) \\ (e_+ - e_-) - (e_+^{-T} + e_-^{-T})B & (e_+^{-T} + e_-^{-T}) \end{pmatrix},$$

where $e_+, e_- \in C^\infty(U_i, O(d))$ are thought of as two ordinary vielbein fields, and where B is any smooth skew-symmetric $n \times n$ -matrix valued function on $\mathbb{R}^d \simeq U_i$.

By an $O(d) \times O(d)$ -transformation this can always be brought into a form where $e_+ = e_- =: \frac{1}{2}e$ such that

$$E = \begin{pmatrix} e & 0 \\ -e^{-T}B & e^{-T} \end{pmatrix}.$$

The corresponding “generalized metric” over U_i is

$$E^T E = \begin{pmatrix} e^T & Be^{-1} \\ 0 & e^{-1} \end{pmatrix} \begin{pmatrix} e & 0 \\ -e^{-T}B & e^{-T} \end{pmatrix} = \begin{pmatrix} g - Bg^{-1}B & Bg^{-1} \\ -g^{-1}B & g^{-1} \end{pmatrix},$$

where

$$g := e^T e$$

is the metric (over $\mathbb{R}^d \simeq U_i$ a smooth function with values in symmetric $n \times n$ -matrices) given by the ordinary vielbein e .

5.2.4.3 U-duality geometry / exceptional generalized geometry The scalar and bosonic fields of 11-dimensional supergravity compactified on tori to dimension d *locally* have moduli spaces identified with the quotients $E_{n(n)}/H_n$ of the split real form $E_{n(n)}$ in the E-series of exceptional Lie groups by their maximal compact subgroups H_n , where $n = 11 - d$. The canonical action of $E_{n(n)}$ on this coset space – or of a certain discrete subgroup $E_{n(n)}(\mathbb{Z}) \hookrightarrow E_{n(n)}$ – is called the *U-duality* global symmetry of the supergravity, or of its string UV-completion, respectively [HT94].

In [Hull07] it was pointed out that therefore the geometry of the field content of compactified supergravity should be encoded by a *exceptional generalized geometry* which in direct analogy to the variant of *generalized complex geometry* that controls the NS-NS sector of type II strings, as discussed above in 5.2.4.2, is encoded by vielbein fields that exhibit reduction of a structure group along the inclusion $H_n \hookrightarrow E_{n(n)}$.

By the general discussion in 5.2.4, we have that all these geometries are encoded by twisted differential **c**-structures, where

$$\mathbf{c} : \mathbf{B}H_n \rightarrow \mathbf{B}E_{n(n)}$$

is the induced morphism of smooth moduli stacks.

5.2.5 Orientifolds and higher orientifolds

We discuss the notion of circle n -bundles with connection over double covering spaces with *orientifold* structure (see [SSW05] and [DiFrMo11] for the notion of orientifolds for 2-bundles).

Proposition 5.2.34. *The smooth automorphism 2-group of the circle group $U(1)$ is that corresponding to the smooth crossed module (as discussed in 2.2.6)*

$$\mathrm{AUT}(U(1)) \simeq [U(1) \rightarrow \mathbb{Z}_2],$$

where the differential $U(1) \rightarrow \mathbb{Z}_2$ is trivial and where the action of \mathbb{Z}_2 on $U(1)$ is given under the identification of $U(1)$ with the unit circle in the plane by reversal of the sign of the angle.

This is an extension of smooth ∞ -groups, def. 3.6.242, of \mathbb{Z}_2 by the circle 2-group $\mathbf{BU}(1)$:

$$\mathbf{BU}(1) \rightarrow \mathrm{AUT}(U(1)) \rightarrow \mathbb{Z}_2.$$

Proof. The nature of $\mathrm{AUT}(U(1))$ is clear by definition. Let $\mathbf{BU}(1) \rightarrow \mathrm{AUT}(U(1))$ be the evident inclusion. We have to show that its delooping is the homotopy fiber of $\mathbf{BAUT}(U(1)) \rightarrow \mathbf{B}\mathbb{Z}_2$.

Passing to the presentation of $\mathrm{Smooth}\infty\mathrm{Grpd}$ by the model structure on simplicial presheaves $[\mathrm{CartSp}_{\mathrm{smooth}}^{\mathrm{op}}, \mathrm{sSet}]_{\mathrm{proj}, \mathrm{loc}}$ and using prop. 2.3.13, it is sufficient to show that the simplicial presheaf $\mathbf{B}^2U(1)_c$ from 4.4.2 is equivalent to the ordinary pullback of simplicial presheaves $\mathbf{BAUT}(U(1))_c \times_{\mathbf{B}\mathbb{Z}_2} \mathbf{E}\mathbb{Z}_2$ of the \mathbb{Z}_2 -universal principal bundle, as discussed in 1.2.5.

This pullback is the 2-groupoid whose

- objects are elements of \mathbb{Z}_2 ;
- morphisms $\sigma_1 \rightarrow \sigma_2$ are labeled by $\sigma \in \mathbb{Z}_2$ such that $\sigma_2 = \sigma\sigma_1$;
- all 2-morphisms are endomorphisms, labeled by $c \in U(1)$;
- vertical composition of 2-morphisms is given by the group operation in $U(1)$,
- horizontal composition of 1-morphisms with 1-morphisms is given by the group operation in \mathbb{Z}_2
- horizontal composition of 1-morphisms with 2-morphisms (*whiskering*) is given by the action of \mathbb{Z}_2 on $U(1)$.

Over each $U \in \mathrm{CartSp}$ this 2-groupoid has vanishing π_1 , and $\pi_2 = U(1)$. The inclusion of $\mathbf{B}^2U(1)$ into this pullback is given by the evident inclusion of elements in $U(1)$ as endomorphisms of the neutral element in \mathbb{Z}_2 . This is manifestly an isomorphism on π_2 and trivially an isomorphism on all other homotopy groups. Therefore it is a weak equivalenc. \square

Observation 5.2.35. A $U(1)$ -gerbe in the full sense Giraud (see [L-Topos], section 7.2.2) as opposed to a $U(1)$ -bundle gerbe / circle 2-bundle is equivalent to an $\mathrm{AUT}(U(1))$ -principal 2-bundle, not in general to a circle 2-bundle, which is only a special case.

More generally we have:

Proposition 5.2.36. *For every $n \in \mathbb{N}$ the automorphism $(n+1)$ -group of $\mathbf{B}^nU(1)$ is given by the crossed complex (as discussed in 2.2.6)*

$$\mathrm{AUT}(\mathbf{B}^nU(1)) \simeq [U(1) \rightarrow 0 \rightarrow \cdots \rightarrow 0 \rightarrow \mathbb{Z}_2]$$

with $U(1)$ in degree $n+1$ and \mathbb{Z}_2 acting by automorphisms. This is an extension of smooth ∞ -groups

$$\mathbf{B}^{n+1}U(1) \longrightarrow \mathrm{AUT}(\mathbf{B}^nU(1)) \longrightarrow \mathbb{Z}_2 .$$

With slight abuse of notation we also write

$$\mathbf{B}^n U(1) // \mathbb{Z}_2 := \mathbf{BAUT}(\mathbf{B}^{n-1} U(1)).$$

Definition 5.2.37. Write

$$\mathbf{J}_n : \mathbf{B}^{n+1} U(1) // \mathbb{Z}_2 \rightarrow \mathbf{B}\mathbb{Z}_2$$

for the corresponding universal characteristic map.

Definition 5.2.38. For $X \in \text{Smooth}\infty\text{Grpd}$, a *double cover* $\hat{X} \rightarrow X$ is a \mathbb{Z}_2 -principal bundle.

For $n \in \mathbb{N}$, $n \geq 1$, an *orientifold circle n -bundle (with connection)* is an $\text{AUT}(\mathbf{B}^{n-1} U(1))$ -principal ∞ -bundle (with ∞ -connection) on X that extends $\hat{X} \rightarrow X$ (by def. 3.6.242) with respect to the extension of \mathbb{Z}_2 by $\text{AUT}(\mathbf{B}^n U(1))$, prop. 5.2.36.

This means that relative to a cocycle $g : X \rightarrow \mathbf{B}\mathbb{Z}^2$ for a double cover \hat{X} , the structure of an orientifold circle n -bundle is a factorization of this cocycle as

$$g : X \xrightarrow{\hat{g}} \mathbf{BAUT}(\mathbf{B}^{n-1} U(1)) \rightarrow \mathbf{B}\mathbb{Z}^2$$

where \hat{g} is the cocycle for the corresponding $\text{AUT}(\mathbf{B}^n U(1))$ -principal ∞ -bundle.

Proposition 5.2.39. *Every orientifold circle n -bundle (with connection) on X induces an ordinary circle n -bundle (with connection) $\hat{P} \rightarrow \hat{X}$ on the given double cover \hat{X} such that restricted to any fiber of \hat{X} this is equivalent to $\text{AUT}(\mathbf{B}^{n-1} U(1)) \rightarrow \mathbb{Z}_2$.*

Proof. There is a pasting diagram of ∞ -pullbacks of the form

$$\begin{array}{ccccccc} (U(1) \rightarrow \cdots \rightarrow \mathbb{Z}_2)^\rho & \longrightarrow & P & \longrightarrow & * & & \\ \downarrow & & \downarrow & & \downarrow & & \\ \mathbb{Z}_2 & \longrightarrow & \hat{X} & \longrightarrow & \mathbf{B}^n U(1) & \longrightarrow & * \\ \downarrow & & \downarrow & & \downarrow & & \downarrow \\ * & \xrightarrow{x} & X & \xrightarrow{g} & \mathbf{B}^n U(1) // \mathbb{Z}_2 & \xrightarrow{\mathbf{J}_{n-1}} & \mathbf{B}\mathbb{Z}_2 \end{array}$$

□

Proposition 5.2.40. *Orientifold circle 2-bundles over a smooth manifold are equivalent to the Jandl gerbes introduced in [SSW05].*

Proof. By prop. 4.3.39 we have that $[U(1) \rightarrow \mathbb{Z}_2]$ -principal ∞ -bundles on X are given by Čech cocycles relative to any good open cover of X with coefficients in the sheaf of 2-groupoids $\mathbf{B}[U(1) \rightarrow \mathbb{Z}_2]$. Writing this out in components it is straightforward to check that this coincides with the data of a Jandl gerbe (with connection) over this cover. □

Remark 5.2.41. Orientifold circle n -bundles are not \mathbb{Z}_2 -equivariant circle n -bundles: in the latter case the orientation reversal acts by an equivalence between the bundle and its pullback along the orientation reversal, whereas for an orientifold circle n -bundle the orientation reversal acts by an equivalence to the *dual* of the pulled-back bundle.

Proposition 5.2.42. *The geometric realization, def. 3.8.2,*

$$\tilde{R} := |\mathbf{B}[U(1) \rightarrow \mathbb{Z}_2]|$$

of $\mathbf{B}[U(1) \rightarrow \mathbb{Z}]$ is the homotopy 3-type with homotopy groups

$$\begin{aligned}\pi_0(\tilde{R}) &= 0; \\ \pi_1(\tilde{R}) &= \mathbb{Z}_2; \\ \pi_2(\tilde{R}) &= 0; \\ \pi_3(\tilde{R}) &= \mathbb{Z}\end{aligned}$$

and nontrivial action of π_1 on π_3 .

Proof. By prop. 4.4.27 and the results of 4.3.8 we have

1. specifically

- (a) $|\mathbf{B}\mathbb{Z}_2| \simeq B\mathbb{Z}_2$;
- (b) $|\mathbf{B}^2U(1)| \simeq B^2U(1) \simeq K(\mathbb{Z}; 3)$;

where on the right we have the ordinary classifying spaces going by these names;

2. generally geometric realization preserves fiber sequences of nice enough objects, such as those under consideration, so that we have a fiber sequence

$$K(\mathbb{Z}, 3) \rightarrow \tilde{R} \rightarrow B\mathbb{Z}_2$$

in Top.

Since $\pi_3(K(\mathbb{Z}, 3)) \simeq \mathbb{Z}$ and $\pi_1(B\mathbb{Z}_2) \simeq \mathbb{Z}_2$ and all other homotopy groups of these two spaces are trivial, the homotopy groups of \tilde{R} follow by the long exact sequence of homotopy groups associated to our fiber sequence.

Finally, since the action of \mathbb{Z}_2 in the crossed module is nontrivial, $\pi_1(\tilde{R})$ must act nontrivially on $\pi_3(\tilde{R})$. It can only act nontrivial in a single way, up to homotopy. \square

The space

$$R := \mathbb{Z}_2 \times \tilde{R}$$

is taken to be the coefficient object for orientifold (differential) cohomology as appearing in string theory in [DiFrMo11].

The following definition gives the differential refinement of $\mathbf{BAUT}(\mathbf{B}^{n-1}U(1))$. With slight abuse of notation we will also write

$$\mathbf{B}^nU(1)//\mathbb{Z}_2 := \mathbf{BAUT}(\mathbf{B}^{n-1}U(1)).$$

Definition 5.2.43. For $n \geq 2$ write $\mathbf{B}^nU(1)_{\text{conn}}//\mathbb{Z}_2$ for the smooth n -stack presented by the presheaf of n -groupoids which is given by the presheaf of crossed complexes of groupoids

$$\begin{aligned}\Omega^n(-) \times C^\infty(-, U(1)) &\xrightarrow{(\text{id}, d_{\text{dR}} \log)} \Omega^n(-) \times \Omega^1(-) \xrightarrow{(\text{id}, d_{\text{dR}})} \dots \xrightarrow{(\text{id}, d_{\text{dR}})} \Omega^n(-) \times \Omega^{n-2}(-) \xrightarrow{(\text{id}, d_{\text{dR}})} \\ &\xrightarrow{(\text{id}, d_{\text{dR}})} \Omega^n(-) \times \Omega^{n-1}(-) \times \mathbb{Z}_2 \rightrightarrows \Omega^n(-),\end{aligned}$$

where

1. the groupoid on the right has as morphisms $(A, \sigma) : B \rightarrow B'$ between two n -forms B, B' pairs consisting of an $(n-1)$ -form A and an element $\sigma \in \mathbb{Z}_2$, such that $(-1)^\sigma B' = B + dA$;

2. the bundles of groups on the left are all trivial as bundles;
3. the $\Omega^1(-) \times \mathbb{Z}_2$ -action is by the \mathbb{Z}_2 -factor only and on forms given by multiplication by ± 1 and on $U(1)$ -valued functions by complex conjugation (regarding $U(1)$ as the unit circle in the complex plane).

Remark 5.2.44. A detailed discussion of $\mathbf{B}^2U(1)_{\text{conn}}//\mathbb{Z}_2$ is in [ScWa08] and [ScWa08].

We now discuss differential cocycles with coefficients in $\mathbf{B}^nU(1)_{\text{conn}}//\mathbb{Z}_2$ over \mathbb{Z}_2 -quotient stacks / orbifolds. Let Y be a smooth manifold equipped with a smooth \mathbb{Z}_2 -action ρ . Write $Y//\mathbb{Z}_2$ for the corresponding global orbifold and $\rho : Y//\mathbb{Z}_2 \rightarrow \mathbf{B}\mathbb{Z}_2$ for its classifying morphism, hence for the morphism that fits into a fiber sequence of smooth stacks

$$Y \longrightarrow Y//\mathbb{Z}_2 \longrightarrow \mathbf{B}\mathbb{Z}_2 .$$

Definition 5.2.45. An n -orientifold structure \hat{G}_ρ on (Y, ρ) is a ρ -twisted $\hat{\mathbf{J}}_n$ -structure on $Y//\mathbb{Z}_2$, def. 3.9.61, hence a dashed morphism in the diagram

$$\begin{array}{ccc} & \mathbf{B}^{n+1}U(1)_{\text{conn}}//\mathbb{Z}_2 & . \\ & \hat{G}_\rho \nearrow & \downarrow \hat{\mathbf{J}}_n \\ Y//\mathbb{Z}_2 & \xrightarrow{\rho} & \mathbf{B}\mathbb{Z}_2 \end{array}$$

Observation 5.2.46. By corollary 5.2.39, an n -orientifold structure decomposes into an ordinary $(n+1)$ -form connection \hat{G} on a circle $(n+1)$ -bundle over Y , subject to a \mathbb{Z}_2 -twisted \mathbb{Z}_2 -equivariance condition

$$\begin{array}{ccccc} Y & \xrightarrow{\hat{G}} & \mathbf{B}^{n+1}U(1)_{\text{conn}} & \longrightarrow & * \\ \downarrow & & \downarrow & & \downarrow \\ Y//\mathbb{Z}_2 & \xrightarrow{\hat{G}_\rho} & \mathbf{B}^{n+1}U(1)_{\text{conn}}//\mathbb{Z}_2 & \xrightarrow{\hat{\mathbf{J}}} & \mathbf{B}\mathbb{Z}_2 \\ & & \rho & & \end{array}$$

For $n = 1$ this reproduces, via observation 5.2.40, the *Jandl gerbes with connection* from [SSW05], hence ordinary string orientifold backgrounds, as discussed there. For $n = 2$ this reproduces background structures for membranes as discussed below in 5.2.9.7.

5.2.6 Twisted topological structures in quantum anomaly cancellation

We discuss here cohomological conditions arising from anomaly cancellation in string theory, for various σ -models. In each case we introduce a corresponding notion of topological *twisted structures* and interpret the anomaly cancellation condition in terms of these. This prepares the ground for the material in the following sections, where the differential refinement of these twisted structures is considered and the *differential* anomaly-free field configurations are derived from these.

- 5.2.6.1 – The type II superstring and twisted Spin^c -structures;
- 5.2.6.2 – The heterotic/type I superstring and twisted String-structures;
- 5.2.6.3 – The M2-brane and twisted String^{2a} -structures;
- 5.2.6.4 – The NS-5-brane and twisted Fivebrane-structures;
- 5.2.6.5 – The M5-brane and twisted Fivebrane $^{2a \cup 2a}$ -structures

The content of this section is taken from [SSS09c].

The physics of all the cases we consider involves a manifold X – the *target space* – or a submanifold $Q \hookrightarrow X$ thereof – a *D-brane* –, equipped with

- two principal bundles with their canonically associated vector bundles:
 - a Spin-principal bundle underlying the tangent bundle TX (and we will write TX also to denote that Spin-principal bundle),
 - and a complex vector bundle $E \rightarrow X$ – the “gauge bundle” – associated to a $SU(n)$ -principal bundle or to an E_8 -principal bundle with respect to a unitary representation of E_8 ;
- and an n -gerbe / circle $(n + 1)$ -bundle with class $H^{n+2}(X, \mathbb{Z})$ – the higher background gauge field – denoted $[H_3]$ or $[G_4]$ or similar in the following.

All these structures are equipped with a suitable notion of *connections*, locally given by some differential-form data. The connection on the Spin-bundle encodes the field of gravity, that on the gauge bundle a Yang-Mills field and that on the n -gerbe a higher analog of the electromagnetic field.

The σ -model quantum field theory of a super-brane propagating in such a background (for instance the superstring, or the super 5-brane) has an effective action functional on its bosonic worldvolume fields that takes values, in general, in the fibers of the Pfaffian line bundle of a worldvolume Dirac operator, tensored with a line bundle that remembers the electric and magnetic charges of the higher gauge field. Only if this tensor product *anomaly line bundle* is trivializable is the effective bosonic action a well-defined starting point for quantization of the σ -model. Therefore the Chern-class of this line bundle over the bosonic configuration space is called the *global anomaly* of the system. Conditions on the background gauge fields that ensure that this class vanishes are called *global anomaly cancellation conditions*. These turn out to be conditions on cohomology classes that are characteristic of the above background fields. This is what we discuss now.

But moreover, the anomaly line bundle is canonically equipped with a *connection*, induced from the connections of the background gauge fields, hence induced from their *differential cohomology* data. The curvature 2-form of this connection over the bosonic configuration space is called the *local anomaly* of the σ -model. Conditions on the differential data of the background gauge field that canonically induce a trivialization of this 2-form are called *local anomaly cancellation conditions*. These we consider below in section 5.2.7.3.

The phenomenon of anomaly line bundles of σ -models induced from background field differential cohomology is classical in the physics literature, if only in broad terms. A clear exposition is in [Fr00]. Only recently the special case of the heterotic string σ -model for trivial background gauge bundle has been made fully precise in [Bun09], using a certain model [Wal09] for the differential string structures that we discuss in section 5.2.7.3.

5.2.6.1 The type II superstring and twisted Spin^c-structures The open type II string propagating on a Spin-manifold X in the presence of a background B -field with class $[H_3] \in H^3(X, \mathbb{Z})$ and with endpoints fixed on a D-brane given by an oriented submanifold $Q \hookrightarrow X$, has a global worldsheet anomaly that vanishes if [FrWi99] and only if [EvSa06] the condition

$$[W_3(Q)] + [H_3]|_Q = 0 \in H^3(Q; \mathbb{Z}), \tag{5.4}$$

holds. Here $[W_3(Q)]$ is the third integral Stiefel-Whitney class of the tangent bundle TQ of the brane and $[H_3]|_Q$ denotes the restriction of $[H_3]$ to Q .

Notice that $[W_3(Q)]$ is the obstruction to lifting the orientation structure on Q to a Spin^c-structure. More precisely, in terms of homotopy theory this is formulated as follows, 5.1.7. There is a homotopy pullback

diagram

$$\begin{array}{ccc}
 B\text{Spin}^c & \longrightarrow & * \\
 \downarrow & & \downarrow \\
 BSO & \xrightarrow{W_3} & B^2U(1)
 \end{array} \tag{5.5}$$

of topological spaces, where BSO is the classifying space of the special orthogonal group, where $B^2U(1) \simeq K(\mathbb{Z}, 3)$ is homotopy equivalent to the Eilenberg-MacLane space that classifies degree-3 integral cohomology, and where the continuous map denoted W_3 is a representative of the universal class $[W_3]$ under this classification. This homotopy pullback exhibits the classifying space of the group Spin^c as the homotopy fiber of W_3 . The universal property of the homotopy pullback says that the space of continuous maps $Q \rightarrow B\text{Spin}^c$ is the same (is homotopy equivalent to) the space of maps $o_Q : Q \rightarrow BSO$ that are equipped with a homotopy from the composite $Q \xrightarrow{o_Q} BSO \xrightarrow{W_3} B^2U(1)$ to the trivial cocycle $Q \rightarrow * \rightarrow B^2U(1)$. In other words, for every choice of homotopy filling the outer diagram of

$$\begin{array}{ccccc}
 Q & & & & \\
 \downarrow & \dashrightarrow & & & \\
 o_Q & & B\text{Spin}^c & \longrightarrow & * \\
 & & \downarrow & & \downarrow \\
 & & BSO & \xrightarrow{W_3} & B^2U(1)
 \end{array}$$

there is a contractible space of choices for the dashed arrow such that everything commutes up to homotopy. Since a choice of map $o_Q : Q \rightarrow BSO$ is an *orientation structure* on Q , and a choice of map $Q \rightarrow B\text{Spin}^c$ is a Spin^c -*structure*, this implies that $[W_3(o_Q)]$ is the obstruction to the existence of a Spin^c structure on Q (equipped with o_Q).

Moreover, since Q is a manifold, the functor $\text{Maps}(Q, -)$ that forms mapping spaces out of Q preserves homotopy pullbacks. Since $\text{Maps}(Q, BSO)$ is the *space* of orientation structures, we can refine the discussion so far by noticing that the *space* of Spin^c -structures on Q , $\text{Maps}(Q, B\text{Spin}^c)$, is itself the homotopy pullback in the diagram

$$\begin{array}{ccc}
 \text{Maps}(Q, B\text{Spin}^c) & \longrightarrow & * \\
 \downarrow & & \downarrow \\
 \text{Maps}(Q, BSO) & \xrightarrow{\text{Maps}(Q, W_3)} & \text{Maps}(Q, B^2U(1))
 \end{array} \tag{5.6}$$

A variant of this characterization will be crucial for the definition of (spaces of) *twisted* such structures below.

These kinds of arguments, even though elementary in homotopy theory, are of importance for the interpretation of anomaly cancellation conditions that we consider here. Variants of these arguments (first for other topological structures, then with twists, then refined to smooth and differential structures) will appear over and over again in our discussion

So in the case that the class of the B -field vanishes on the D-brane, $[H_3]|_Q = 0$, hence that its representative $H_3 : Q \rightarrow K(\mathbb{Z}, 3)$ factors through the point, up to homotopy, condition (5.4) states that the oriented D-brane Q must admit a Spin^c -structure, namely a choice of null-homotopy η in

$$\begin{array}{ccc}
 Q & \xrightarrow{o_Q} & BSO \\
 \searrow & \swarrow \eta & \downarrow W_3 \\
 & & K(\mathbb{Z}, 3) \\
 & \nearrow H_3|_Q \simeq * &
 \end{array} \tag{5.7}$$

(Beware that there are such homotopies filling *all* our diagrams, but only in some cases, such as here, do we want to make them explicit and given them a name.) If, generally, $[H_3]_Q$ does not necessarily vanish, then condition (5.4) still is equivalent to the existence of a homotopy η in a diagram of the above form:

$$\begin{array}{ccc}
 Q & \xrightarrow{o_Q} & BSO \\
 & \searrow \eta & \downarrow W_3 \\
 & & K(\mathbb{Z}, 3) \\
 & \swarrow H_3|_Q & \\
 & &
 \end{array} . \tag{5.8}$$

We may think of this as saying that η still “trivializes” $W_3(o_Q)$, but not with respect to the canonical trivial cocycle, but with respect to the given reference background cocycle $H_3|_Q$ of the B -field. Accordingly, following [Wa08], we may say that such an η exhibits not a Spin^c -structure on Q , but an $[H_3]_Q$ -twisted Spin^c -structure.

For this notion to be useful, we need to say what an equivalence or homotopy between two twisted Spin^c -structures is, what a homotopy between such homotopies is, etc., hence what the *space* of twisted Spin^c -structures is. But by generalization of (5.6) we naturally have such a space.

Definition 5.2.47. For X a manifold and $[c] \in H^3(X, \mathbb{Z})$ a degree-3 cohomology class, we say that the space $W_3\text{Struc}(Q)_{[c]}$ defined as the homotopy pullback

$$\begin{array}{ccc}
 W_3\text{Struc}(Q)_{[H_3]|_Q} & \xrightarrow{\quad} & * \\
 \downarrow & \lrcorner & \downarrow c \\
 \text{Maps}(Q, BSO) & \xrightarrow{\text{Maps}(Q, W_3)} & \text{Maps}(Q, B^2U(1))
 \end{array} , \tag{5.9}$$

is the *space of $[c]$ -twisted Spin^c -structures* on X , where the right vertical morphism picks any representative $c : X \rightarrow B^2U(1) \simeq K(\mathbb{Z}, 3)$ of $[c]$.

In terms of this notion, the anomaly cancellation condition (5.4) is now read as encoding *existence of structure*:

Observation 5.2.48. On an oriented manifold Q , condition (5.4) precisely guarantees the existence of $[H_3]|_Q$ -twisted W_3 -structure, provided by a lift of the orientation structure o_Q on TQ through the left vertical morphism in def. 5.9.

This makes good sense, because that extra structure is the extra structure of the background field of the σ -model background, subjected to the condition of anomaly freedom. This we will see in more detail in the following examples, and then in section 5.2.7.3.

5.2.6.2 The heterotic/type I superstring and twisted String-structures The heterotic/type I string, propagating on a Spin-manifold X and coupled to a gauge field given by a Hermitean complex vector bundle $E \rightarrow X$, has a global anomaly that vanishes if the *Green-Schwarz anomaly cancellation condition* [GrSc]

$$\frac{1}{2}p_1(TX) - \text{ch}_2(E) = 0 \in H^4(X; \mathbb{Z}) . \tag{5.10}$$

holds. Here $\frac{1}{2}p_1(TX)$ is the *first fractional Pontryagin class* of the Spin-bundle, and $\text{ch}_2(E)$ is the second Chern-class of E .

As before, this means that at the level of cocycles a certain homotopy exists. Here it is this homotopy which is the representative of the B -field that the string couples to.

In detail, write $\frac{1}{2}p_1 : B\text{Spin} \rightarrow B^3U(1)$ for a representative of the universal first fractional Pontryagin class, prop. 5.1.5, and similarly $\text{ch}_2 : B\text{SU} \rightarrow B^3U(1)$ for a representative of the universal second Chern class, where now $B^3U(1) \simeq K(\mathbb{Z}, 4)$ is equivalent to the Eilenberg-MacLane space that classifies degree-4

integral cohomology. Then if $TX : X \rightarrow B\text{Spin}$ is a classifying map of the Spin-bundle and $E : X \rightarrow BSU$ one of the gauge bundle, the anomaly cancellation condition above says that there is a homotopy, denoted H_3 , in the diagram

$$\begin{array}{ccc}
 X & \xrightarrow{E} & BSU \\
 TX \downarrow & \searrow^{H_3} & \downarrow \text{ch}_2 \\
 B\text{Spin} & \xrightarrow{\frac{1}{2}p_1} & B^3U(1)
 \end{array} . \tag{5.11}$$

Notice that if both $\frac{1}{2}p_1(TX)$ as well as $\text{ch}_2(E)$ happen to be trivial, such a homotopy is equivalently a map $H_3 : X \rightarrow \Omega B^3U(1) \simeq B^2U(1)$. So in this special case the B-field in the background of the heterotic string is a $U(1)$ -gerbe, a circle 2-bundle, as in the previous case of the type II string in section 5.2.6.1. Generally, the homotopy H_3 in the above diagram exhibits the B-field as a *twisted* gerbe, whose twist is the difference class $[\frac{1}{2}p_1(TX)] - [\text{ch}_2(E)]$. This is essentially the perspective adopted in [Fr00].

For the general discussion of interest here it is useful to slightly shift the perspective on the twist. Recall that a *String structure*, 5.1.4, on the Spin bundle $TX : X \rightarrow B\text{Spin}$ is a homotopy filling the outer square of

$$\begin{array}{ccc}
 X & \xrightarrow{\quad} & * \\
 \text{---} & \searrow & \downarrow \\
 B\text{String} & \xrightarrow{\quad} & * \\
 TX \downarrow & & \downarrow \\
 B\text{Spin} & \xrightarrow{\frac{1}{2}p_1} & B^3U(1)
 \end{array} ,$$

or, which is equivalent by the universal property of homotopy pullbacks, a choice of dashed morphism filling the interior of this square, as indicated.

Therefore, now by analogy with (5.8), we say that a $[\text{ch}_2(E)]$ -*twisted string structure* is a choice of homotopy H_3 filling the diagram (5.11).

This notion of twisted string structures was originally suggested in [Wa08]. For it to be useful, we need to say what homotopies of twisted String-structures are, homotopies between these, etc. Hence we need to say what the *space* of twisted String-structures is. This is what the following definition provides, analogous to 5.9.

Definition 5.2.49. For X a manifold, and for $[c] \in H^4(X, \mathbb{Z})$ a degree-4 cohomology class, we say that the space of c -*twisted String-structures* on X is the homotopy pullback $\frac{1}{2}p_1\text{Struc}_{[c]}(X)$ in

$$\begin{array}{ccc}
 \frac{1}{2}p_1\text{Struc}_{[c]}(X) & \xrightarrow{\quad} & * \\
 \downarrow & & \downarrow c \\
 \text{Maps}(X, B\text{Spin}) & \xrightarrow{\text{Maps}(X, \frac{1}{2}p_1)} & \text{Maps}(X, B^3U(1))
 \end{array} ,$$

where the right vertical morphism picks a representative c of $[c]$.

In terms of this then, we find

Observation 5.2.50. The anomaly cancellation condition (5.10) is, for a fixed gauge bundle E , precisely the condition that ensures a lift of the given Spin-structure to a $[\text{ch}_2(E)]$ -twisted String-structure on X , through the left vertical morphism of def. 5.2.49.

Of course the full background field content involves more than just this topological data, it also consists of local differential form data, such as a 1-form connection on the bundles E and on TX and a connection 2-form on the 2-bundle H_3 . Below in section 5.2.7.3 we identify this *differential* anomaly-free field content with a *differential* twisted String-structure.

5.2.6.3 The M2-brane and twisted String^{2a} -structures The string theory backgrounds discussed above have lifts to 11-dimensional supergravity/M-theory, where the bosonic background field content consists of just the Spin-bundle TX as well as the C -field, which has underlying it a 2-gerbe – or *circle 3-bundle* – with class $[G_4] \in H^4(X, \mathbb{Z})$. The M2-brane that couples to these background fields has an anomaly that vanishes [Wi97a] if

$$2[G_4] = \left[\frac{1}{2}p_1(TX)\right] - 2[a(E)] \in H^4(X, \mathbb{Z}), \quad (5.12)$$

where $E \rightarrow X$ is an auxiliary E_8 -principal bundle, whose class is defined by this condition.

Since E_8 is 15-coskeletal, this condition is equivalent to demanding that $[\frac{1}{2}p_1(TX)] \in H^4(X, \mathbb{Z})$ is further divisible by 2. In the absence of smooth or differential structure, one could therefore replace the E_8 -bundle here by a circle 2-gerbe, hence by a $B^2U(1)$ -principal bundle, and replace condition (5.12) by

$$2[G_4] = \left[\frac{1}{2}p_1(TX)\right] - 2[DD_2],$$

where $[DD_2]$ is the canonical 4-class of this 2-gerbe (the “second Dixmier-Douady class”). While topologically this condition is equivalent, over an 11-dimensional X , to (5.12), the spaces of solutions of smooth refinements of these two conditions will differ, because the space of smooth gauge transformations between E_8 bundles is quite different from that of smooth gauge transformations between circle 2-bundles. In the Hořava-Witten reduction [HoWi96] of the 11-dimensional theory down to the heterotic string in 10 dimensions, this difference is supposed to be relevant, since the heterotic string in 10 dimensions sees the smooth E_3 -bundle with connection.

In either case, we can understand the situation as a refinement of that described by (twisted) String-structures via a higher analogue of the passage from Spin-structures to Spin^c -structures. To that end recall prop. 5.1.37, which provides an alternative perspective on (5.5).

Due to the universal property of the homotopy pullback, this says, in particular, that a lift from an orientation structure to a Spin^c -structure is a cancelling by a Chern-class of the class obstructing a Spin-structure. In this way lifts from orientation structures to Spin^c -structures are analogous to the divisibility condition (5.12), since in both cases the obstruction to a further lift through the Whitehead tower of the orthogonal group is absorbed by a universal “unitary” class.

In order to formalize this we make the following definition.

Definition 5.2.51. For G some topological group, and $c : BG \rightarrow K(\mathbb{Z}, 4)$ a universal 4-class, we say that String^c is the loop group of the homotopy pullback

$$\begin{array}{ccc} B\text{String}^c & \longrightarrow & BG \\ \downarrow & & \downarrow c \\ B\text{Spin} & \xrightarrow{\frac{1}{2}p_1} & B^3U(1) \end{array}$$

of c along the first fractional Pontryagin class.

For instance for $c = DD_2$ we have that a Spin-structure lifts to a String^{2DD_2} -structure precisely if $\frac{1}{2}p_1$ is further divisible by 2. Similarly, with $a : BE_8 \rightarrow B^3U(1)$ the canonical universal 4-class on E_8 -bundles and X a manifold of dimension $\dim X \leq 14$ we have that a Spin-structure on X lifts to a String^{2a} -structure precisely if $\frac{1}{2}p_1$ is further divisible by 2.

$$\begin{array}{ccccc} & & B\text{String}^{2a} & \longrightarrow & BE_8 \\ & \nearrow & \downarrow & \searrow \frac{1}{4}p_1 & \downarrow 2a \\ X & \longrightarrow & B\text{Spin} & \xrightarrow{\frac{1}{2}p_1} & B^3U(1) \end{array} \quad . \quad (5.13)$$

Using this we can now reformulate the anomaly cancellation condition (5.12) as follows.

Definition 5.2.52. For X a manifold and for $[c] \in H^4(X, \mathbb{Z})$ a cohomology class, the space $(\frac{1}{2}p_1 - 2a)\text{Struc}_{[c]}(X)$ of $[c]$ -twisted String^{2a} -structures on X is the homotopy pullback

$$\begin{array}{ccc} (\frac{1}{2}p_1 - 2a)\text{Struc}_{[c]}(X) & \xrightarrow{\quad\quad\quad} & * \\ \downarrow & & \downarrow c \\ \text{Maps}(X, B\text{Spin} \times E_8) & \xrightarrow{\frac{1}{2}p_1 - 2a} & \text{Maps}(X, B^3U(1)) \end{array},$$

where the right vertical map picks a cocycle c representing the class $[c]$.

In terms of this definition, we have

Observation 5.2.53. Condition (5.12) is precisely the condition guaranteeing a lift of the given Spin- and the given E_8 -principal bundle to a $[G_4]$ -twisted String^{2a} -structure along the left vertical map from def. 5.2.52.

There is a further variation of this situation, that is of interest. In the Hořava-Witten reduction of this situation in 11 dimensions down to the situation of the heterotic string in 10 dimensions, X has a boundary, $Q := \partial X \hookrightarrow X$, and there is a boundary condition on the C -field, saying that the restriction of its 4-class to the boundary has to vanish,

$$[G_4]|_Q = 0.$$

This implies that over Q the anomaly-cancellation condition (5.12) becomes

$$[\frac{1}{2}p_1(TX)]|_Q = 2[a(E)]|_Q \in H^4(Q, \mathbb{Z}).$$

Notice that this is the Green-Schwarz anomaly cancellation condition (5.10) of the heterotic string, but refined by a further cohomological divisibility condition. The following statement says that this may equivalently be reformulated in terms of String^{2a} structures.

Proposition 5.2.54. For $E \rightarrow X$ a fixed E_8 -bundle, we have an equivalence

$$\text{Maps}(X, B\text{String}^{2a})|_E \simeq (\frac{1}{2}p_1)\text{Struc}(X)_{[2a(E)]}$$

between, on the right, the space of $[2a(E)]$ -twisted String -structures from def. 5.2.49, and, on the left, the space of String^{2a} -structures with fixed class $2a$, hence the homotopy pullback $\text{Maps}(X, B\text{String}^{2a}) \times_{\text{Maps}(X, BE_8)} \{E\}$.

Proof. Consider the diagram

$$\begin{array}{ccc} \text{Maps}(X, \text{String}^{2a})|_E & \xrightarrow{\quad\quad\quad} & * \\ \downarrow & & \downarrow E \\ \text{Maps}(X, \text{String}^{2a}) & \xrightarrow{\quad\quad\quad} & \text{Maps}(X, BE_8) \\ \downarrow & & \downarrow \text{Maps}(X, 2a) \\ \text{Maps}(X, B\text{Spin}) & \xrightarrow{\text{Maps}(X, \frac{1}{2}p_1)} & \text{Maps}(X, B^3U(1)) \end{array}$$

The top square is a homotopy pullback by definition. Since $\text{Maps}(X, -)$ preserves homotopy pullbacks (for X a manifold, hence a CW-complex), the bottom square is a homotopy pullback by definition 5.2.51. Therefore, by the pasting law, also the total rectangle is a homotopy pullback. With def. 5.2.49 this implies the claim. \square

Therefore the boundary anomaly cancellation condition for the M2-brane has the following equivalent formulation.

Observation 5.2.55. For X a Spin-manifold equipped with a complex vector bundle $E \rightarrow X$, condition (5.2.6.3) precisely guarantees the existence of a lift to a String^{2a} -structure through the left vertical map in the proof of prop. 5.2.54.

5.2.6.4 The NS-5-brane and twisted Fivebrane-structures The magnetic dual of the (heterotic) string is the NS-5-brane. Where the string is electrically charged under the B_2 -field with class $[H_3] \in H^3(X, \mathbb{Z})$, the NS-5-brane is electrically charged under the B_6 -field with class $[H_7] \in H^7(X, \mathbb{Z})$ [Ch81]. In the presence of a String-structure, hence when $[\frac{1}{2}p_1(TX)] = 0$, the anomaly of the 5-brane σ -model vanishes [SaSe85] [GaNi85] if the background fields satisfy

$$[\frac{1}{6}p_2(TX)] = 8[\text{ch}_4(E)] \in H^8(X, \mathbb{Z}), \quad (5.14)$$

where $\frac{1}{6}p_2(TX)$ is the second fractional Pontryagin class of the String-bundle TX .

It is clear now that a discussion entirely analogous to that of section 5.2.6.2 applies. For the untwisted case the following terminology was introduced in [SSS09b].

Definition 5.2.56. Write $B\text{Fivebrane}$ for the loop group of the homotopy fiber $B\text{Fivebrane}$ of a representative $\frac{1}{6}p_2$ of the universal second fractional Pontryagin class

$$\begin{array}{ccc} B\text{Fivebrane} & \longrightarrow & * \\ \downarrow & & \downarrow \\ B\text{String} & \xrightarrow{\frac{1}{6}p_2} & B^7U(1) \end{array} .$$

In direct analogy with def. 5.2.49 we therefore have the following notion.

Definition 5.2.57. For X a manifold and $[c] \in H^8(X, \mathbb{Z})$ a class, we say that the *space of $[c]$ -twisted Fivebrane-structures* on X , denoted $(\frac{1}{6}p_2)\text{Struc}_{[c]}(X)$, is the homotopy pullback

$$\begin{array}{ccc} (\frac{1}{6}p_2)\text{Struc}_{[c]}(X) & \longrightarrow & * \\ \downarrow & & \downarrow c \\ \text{Maps}(X, B\text{String}) & \xrightarrow{\text{Maps}(X, \frac{1}{6}p_2)} & \text{Maps}(X, B^7U(1)) \end{array} ,$$

In terms of this we have

Observation 5.2.58. For X a manifold with String-structure and with a background gauge bundle $E \rightarrow X$ fixed, condition (5.14) is precisely the condition for the existence of $[8 \text{ch}(E)]$ -twisted Fivebrane-structure on X .

5.2.6.5 The M5-brane and twisted Fivebrane $^{2a \cup 2a}$ -structures The magnetic dual of the M2-brane is the M5-brane. Where the M2-brane is electrically charged under the C_3 -field with class $[G_4] \in H^4(X, \mathbb{Z})$, the M5-brane is electrically charged under the dual C_6 -field with class $[G_8] \in H^8(X, \mathbb{Z})$.

If X admits a String-structure, then one finds a relation for the background fields analogous to (5.12) which reads

$$8[G_8] = 4[a(E)] \cup [a(E)] - [\frac{1}{6}p_2(TX)]. \quad (5.15)$$

The Fivebrane-analog of Spin^c is then the following.

Definition 5.2.59. For G a topological group and $[c] \in H^8(BG, \mathbb{Z})$ a universal 8-class, we say that Fivebrane^c is the loop group of the homotopy pullback

$$\begin{array}{ccc} B\text{Fivebrane}^c & \longrightarrow & BG \\ \downarrow & & \downarrow c \\ B\text{String} & \xrightarrow{\frac{1}{6}p_2} & B^3U(1) \end{array} .$$

In analogy with def. 5.2.52 we have a notion of twisted Fivebrane^c-structures.

Definition 5.2.60. For X a manifold and for $[c] \in H^8(X, \mathbb{Z})$ a cohomology class, the space $(\frac{1}{6}p_2 - 2a \cup 2a)\text{Struc}_{[c]}(X)$ of $[c]$ -twisted Fivebrane^{2a∪2a}-structures on X is the homotopy pullback

$$\begin{array}{ccc} (\frac{1}{6}p_2 - 2a \cup 2a)\text{Struc}_{[c]}(X) & \xrightarrow{\quad} & * \\ \downarrow & & \downarrow c \\ \text{Maps}(X, B\text{String} \times E_8) & \xrightarrow{\frac{1}{6}p_2 - 2a \cup 2a} & \text{Maps}(X, B^7U(1)) \end{array},$$

where the right vertical map picks a cocycle c representing the class $[c]$.

In terms of these notions we thus see that

Observation 5.2.61. Over a manifold X with String-structure and with a fixed gauge bundle E , condition (5.15) is precisely the condition that guarantees existence of a lift to $[8G_8]$ -twisted Fivebrane^{2a∪2a}-structure through the left vertical morphism in def. 5.2.60.

5.2.7 Twisted differential structures in quantum anomaly cancellation

We discuss now the differential refinements of the twisted topological structures from 5.2.6.

This section draws from [SSS09c].

5.2.7.1 Twisted differential \hat{c}_1 -structures We discuss the differential refinement \hat{c}_1 of the universal first Chern class, indicated before in 1.2.9.1. The corresponding \hat{c}_1 -structures are simply $SU(n)$ -principal connections, but the derivation of this fact may be an instructive warmup for the examples to follow.

For any $n \in \mathbb{N}$, let $\mathbf{c}_1 : \mathbf{BU}(n) \rightarrow \mathbf{BU}(1)$ in $\mathbf{H} = \text{Smooth}\infty\text{Grpd}$ be the canonical representative of the universal smooth first Chern class, described in 1.2.135. In terms of the standard presentations $\mathbf{BU}(n)_{\text{ch}}, \mathbf{BU}(1)_{\text{ch}} \in [\text{CartSp}^{\text{op}}, \text{sSet}]$ of its domain and codomain from prop. 4.4.19 this is given by the determinant function, which over any $U \in \text{CartSp}$ sends

$$\det : C^\infty(U, U(n)) \rightarrow C^\infty(U, U(1)).$$

Write $\mathbf{BU}(n)_{\text{conn}}$ for the differential refinement from prop. 1.2.107. Over a test space $U \in \text{CartSp}$ the set of objects is the set of $\mathfrak{u}(n)$ -valued differential forms

$$\mathbf{BU}(n)_{\text{conn}}(U)_0 = \Omega^1(U, \mathfrak{u}(n))$$

and the set of morphisms is that of smooth $U(n)$ -valued differential forms, acting by gauge transformations on the $\mathfrak{u}(n)$ -valued 1-forms

$$\mathbf{BU}(n)_{\text{conn}}(U)_1 = \Omega^1(U, \mathfrak{u}(n)) \times C^\infty(U, U(n)).$$

Proposition 5.2.62. *The smooth universal first Chern class has a differential refinement*

$$\hat{c}_1 : \mathbf{BU}(n)_{\text{conn}} \rightarrow \mathbf{BU}(1)_{\text{conn}}$$

given on $\mathfrak{u}(n)$ -valued 1-forms by taking the trace

$$\text{tr} : \mathfrak{u}(n) \rightarrow \mathfrak{u}(1).$$

The existence of this refinement allows us to consider differential and twisted differential \hat{c}_1 -structures.

Lemma 5.2.63. *There is an ∞ -pullback diagram*

$$\begin{array}{ccc} \mathbf{BSU}(n)_{\text{conn}} & \longrightarrow & * \\ \downarrow & & \downarrow \\ \mathbf{BU}(n)_{\text{conn}} & \longrightarrow & \mathbf{BU}(1)_{\text{conn}} \end{array}$$

in $\text{Smooth}\infty\text{Grpd}$.

Proof. We use the factorization lemma, 2.3.9, to resolve the right vertical morphism by a fibration

$$\mathbf{EU}(1)_{\text{conn}} \rightarrow \mathbf{BU}(1)_{\text{conn}}$$

in $[\text{CartSp}^{\text{op}}, \text{sSet}]_{\text{proj}}$. This gives that an object in $\mathbf{EU}(1)_{\text{conn}}$ over some test space U is a morphism of the form $0 \xrightarrow{g} g^{-1}d_U g$ for $g \in C^\infty(U, U(1))$, and a morphism in $\mathbf{EU}(1)_{\text{conn}}$ is given by a commuting diagram

$$\mathbf{EU}(1)_{\text{conn}} = \left\{ \begin{array}{ccc} & 0 & \\ g_1 \swarrow & & \searrow g_2 \\ g_1^{-1}d_U g_1 & \xrightarrow{h} & g_2^{-1}d_U g_2 \end{array} \right\},$$

where on the right we have $h \in C^\infty(U, U(1))$ such that $hg_1 = g_2$. The morphism to $\mathbf{BU}(1)_{\text{conn}}$ is given by the evident projection onto the lower horizontal part of these triangles.

Then the ordinary 1-categorical pullback of $\mathbf{EU}(1)_{\text{conn}}$ along $\hat{\mathbf{c}}_1$ yields the smooth groupoid $\hat{\mathbf{c}}_1^* \mathbf{EU}(1)_{\text{conn}}$ given over any test space U as follows.

- objects are pairs consisting of a $\mathfrak{u}(n)$ -valued 1-form $A \in \Omega^1(U, \mathfrak{u}(n))$ and a smooth function $\rho \in C^\infty(U, U(1))$ such that

$$\text{tr} A = \rho^{-1} d\rho;$$

- morphisms $g : (A_1, \rho_1) \rightarrow (A_2, \rho_2)$ are labeled by a smooth function $g \in C^\infty(U, U(n))$ such that $A_2 = g^{-1}(A_1 + d_U)g$.

Therefore there is a canonical functor

$$\mathbf{BSU}(n)_{\text{conn}} \rightarrow \hat{\mathbf{c}}_1^* \mathbf{EU}(1)_{\text{conn}}$$

induced from the defining inclusion $\text{SU}(n) \rightarrow \text{U}(n)$, which hits precisely the objects for which ρ is the constant function on $1 \in U(1)$ and which is a bijection to the morphisms between these objects, hence is full and faithful. The functor is also essentially surjective, since every 1-form of the form $h^{-1}dh$ is gauge equivalent to the identically vanishing 1-form. Therefore it is a weak equivalence in $[\text{CartSp}^{\text{op}}, \text{sSet}]_{\text{proj}}$. By prop. 2.3.13 this proves the claim. \square

Proposition 5.2.64. *For X a smooth manifold, we have an ∞ -pullback of smooth groupoids*

$$\begin{array}{ccc} \text{SU}(n)\text{Bund}_{\nabla}(X) & \longrightarrow & * \\ \downarrow & & \downarrow \\ \text{U}(n)\text{Bund}_{\nabla}(X) & \xrightarrow{\hat{\mathbf{c}}_1} & \text{U}(1)\text{Bund}_{\nabla}(X) \end{array} .$$

Proof. This follows from lemma 5.2.63 and the facts that for a Lie group G we have $\mathbf{H}(X, \mathbf{BG}_{\text{conn}}) \simeq G\text{Bund}_{\nabla}(X)$ and that the hom-functor $\mathbf{H}(X, -)$ preserves ∞ -pullbacks. \square

5.2.7.2 Twisted differential spin^c -structures As opposed to the Spin-group, which is a \mathbb{Z}_2 -extension of the special orthogonal group, the Spin^c -group, def. 5.1.36, is a $U(1)$ -extension of SO . This means that twisted Spin^c -structures have interesting smooth refinements. These we discuss here.

Two standard properties of Spin^c are the following (see [LaMi89]).

Observation 5.2.65. There is a short exact sequence

$$U(1) \rightarrow \text{Spin}^c \rightarrow \text{SO}$$

of Lie groups, where the first morphism is the canonical inclusion.

Proposition 5.2.66. *There is a fiber sequence*

$$B\text{Spin}^c(n) \rightarrow B\text{SO}(n) \xrightarrow{W_3} K(\mathbb{Z}, 3)$$

of classifying spaces in Top , where W_3 is a representative of the universal third integral Stiefel-Whitney class.

Here W_3 is a classical definition, but, as we will show below, the reader can think of it as being defined as the geometric realization of the smooth characteristic class \mathbf{W}_3 from example 1.2.141. Before turning to that, we record the notion of twisted structure induced by this fact:

Definition 5.2.67. For X an oriented manifold of dimension n , a Spin^c -structure on X is a trivialization

$$\eta : * \xrightarrow{\cong} W_3(o_X),$$

where $o_X : X \rightarrow B\text{SO}$ is the given orientation structure.

Observation 5.2.68. This is equivalently a lift \hat{o}_X of o_X :

$$\begin{array}{ccc} & & B\text{Spin}^c \\ & \nearrow \hat{o}_X & \downarrow \\ X & \xrightarrow{o_X} & B\text{SO} \end{array}$$

Proof. By prop. 5.2.66 and the universal property of the homotopy pullback:

$$\begin{array}{ccccc} X & & & & \\ & \searrow \hat{o}_X & & \searrow & \\ & & B\text{Spin}^c & \longrightarrow & * \\ & \searrow o_X & \downarrow & & \downarrow \\ & & B\text{SO} & \xrightarrow{W_3} & K(\mathbb{Z}, 3) \end{array}$$

□

From the general reasoning of twisted cohomology, def. 3.6.222, in the language of twisted c-structures, def. 3.9.61, we are therefore led to consider the following.

Definition 5.2.69. The ∞ -groupoid of *twisted spin^c -structures* on X is $W_3\text{Struct}_{\text{tw}}(X)$.

Remark 5.2.70. It follows from the definition that twisted spin^c -structures over an orientation structure o_X , def. 5.1.2, are naturally identified with equivalences (homotopies)

$$\eta : c \xrightarrow{\cong} W_3(o_X),$$

where $c \in \infty\text{Grpd}(X, B^2U(1))$ is a given twisting cocycle.

In this form twisted spin^c -structures have been considered in [Do06] and in [Wa08]. We now establish a smooth refinement of this situation.

Observation 5.2.71. There is an essentially unique lift in $\text{Smooth}\infty\text{Grpd}$ of W_3 through the geometric realization

$$|-| : \text{Smooth}\infty\text{Grpd} \xrightarrow{\Pi} \infty\text{Grpd} \xrightarrow{\simeq} \text{Top}$$

(discussed in 4.4.4) of the form

$$\mathbf{W}_3 : \mathbf{BSO} \rightarrow \mathbf{B}^2U(1),$$

where \mathbf{BSO} is the delooping of the Lie group SO in $\text{Smooth}\infty\text{Grpd}$ and $\mathbf{B}^2U(1)$ that of the smooth circle 2-group, as in 4.4.2.

Proof. This is a special case of theorem 4.4.36. □

Theorem 5.2.72. In $\text{Smooth}\infty\text{Grpd}$ we have a fiber sequence of the form

$$\mathbf{BSpin}^c \rightarrow \mathbf{BSO} \xrightarrow{\mathbf{W}_3} \mathbf{B}^2U(1),$$

which refines the sequence of prop. 5.2.66.

We consider first a lemma.

Lemma 5.2.73. A presentation of the essentially unique smooth lift of W_3 from observation 5.2.71, is given by the morphism of simplicial presheaves

$$\mathbf{W}_3 : \mathbf{BSO}_{\text{ch}} \xrightarrow{\mathbf{w}_3} \mathbf{B}^2\mathbb{Z}_2 \xrightarrow{\beta_2} \mathbf{B}^2U(1)_{\text{ch}},$$

where the first morphism is that of example 1.2.139 and where the second morphism is the one induced from the canonical subgroup embedding.

Proof. The bare Bockstein homomorphism is presented, by example 1.2.140, by the ∞ -anafunctor

$$\begin{array}{ccc} \mathbf{B}^2(\mathbb{Z} \xrightarrow{\cdot 2} \mathbb{Z}) & \longrightarrow & \mathbf{B}^2(\mathbb{Z} \rightarrow 1) \equiv \mathbf{B}^3\mathbb{Z} \\ \downarrow \simeq & & \\ \mathbf{B}^2\mathbb{Z}_2 & & \end{array}$$

Accordingly we need to consider the lift of the morphism

$$\beta_2 : \mathbf{B}^2\mathbb{Z}_2 \rightarrow \mathbf{B}^2U(1)$$

induced from subgroup inclusion to to a comparable ∞ -anafunctor. This is accomplished by

$$\begin{array}{ccc} \mathbf{B}^2(\mathbb{Z} \xrightarrow{\cdot 2} \mathbb{Z}) & \xrightarrow{\hat{\beta}_2} & \mathbf{B}^2(\mathbb{Z} \xrightarrow{\cdot 2} \mathbb{R}) \\ \downarrow \simeq & & \downarrow \simeq \\ \mathbf{B}^2\mathbb{Z}_2 & \xrightarrow{\beta_2} & \mathbf{B}^2U(1) \end{array}$$

Since \mathbb{R} is contractible, we have indeed under geometric realization, 4.3.4, an equivalence

$$\begin{array}{ccc}
|\mathbf{B}^2(\mathbb{Z} \rightrightarrows \mathbb{Z})| & \xrightarrow{|\hat{\beta}_2|} & |\mathbf{B}^2(\mathbb{Z} \rightrightarrows \mathbb{R})| \\
\downarrow \simeq & & \downarrow \simeq \\
|\mathbf{B}^2(\mathbb{Z} \rightrightarrows \mathbb{Z})| & \longrightarrow & |\mathbf{B}^2(\mathbb{Z} \rightarrow 1)| \\
\downarrow \simeq & & \downarrow \simeq \\
|\mathbf{B}^2\mathbb{Z}_2| & \xrightarrow{|\beta_2|} & |\mathbf{B}^3\mathbb{Z}|
\end{array}$$

where $|\beta_2|$ is the geometric realization of β_2 , according to definition 4.3.24. □

Proof of theorem 5.2.72. Consider the pasting diagram in $\text{Smooth}\infty\text{Grpd}$

$$\begin{array}{ccccc}
\mathbf{B}\text{Spin}^c & \longrightarrow & \mathbf{B}U(1) & \longrightarrow & * \\
\downarrow & & \downarrow c_1 \bmod 2 & & \downarrow \\
\mathbf{B}\text{Spin} & \xrightarrow{w_2} & \mathbf{B}^2\mathbb{Z}_2 & \xrightarrow{\beta_2} & \mathbf{B}^2U(1)
\end{array}$$

The square on the right is an ∞ -pullback by prop. 4.4.41. The square on the left is an ∞ -pullback by proposition 5.1.37. Therefore by the pasting law 2.3.2 the total outer rectangle is an ∞ -pullback. By lemma 5.2.73 the composite bottom morphism is indeed the smooth lift \mathbf{W}_3 from observation 5.2.71. □

Therefore we are entitled to the following smooth refinement of def. 5.2.69.

Remark 5.2.74. $\mathbf{B}\text{Spin}^c$ is the moduli stack of Spin^c -structures, or, equivalently Spin^c -principal bundles.

Definition 5.2.75. For any $X \in \text{Smooth}\infty\text{Grpd}$, the 1-groupoid of smooth *twisted spin^c-structures* $\mathbf{W}_3\text{Struct}_{\text{tw}}(X)$ is the homotopy pullback

$$\begin{array}{ccc}
\mathbf{W}_3\text{Struct}_{\text{tw}}(X) & \longrightarrow & H^3(X, \mathbb{Z}) \\
\downarrow & & \downarrow \\
\text{Smooth}\infty\text{Grpd}(X, \mathbf{B}\text{SO}) & \xrightarrow{\mathbf{W}_3} & \text{Smooth}\infty\text{Grpd}(X, \mathbf{B}^2U(1))
\end{array}$$

We briefly discuss an application of smooth twisted spin^c -structures in physics.

Remark 5.2.76. The action functional of the σ -model of the open type II superstring on a 10-dimensional target X has in general an anomaly, in that it is not a function, but just a section of a possibly non-trivial line bundle over the bosonic configuration space. In [FrWi99] it was shown that in the case that the D-branes $Q \hookrightarrow X$ that the open string ends on carry a rank-1 Chan-Paton bundle, this anomaly vanishes precisely if this Chan-Paton bundle is a twisted line bundle exhibiting an equivalence $\mathbf{W}_3(\mathfrak{o}_Q) \simeq H|_Q$ between the lifting gerbe of the spin^c -structure and the restriction of the background Kalb-Ramond 2-bundle to Q . By the above discussion we see that this is precisely the datum of a smooth twisted spin^c -structure on Q , where the Kalb-Ramond field serves as the twist. Below in 5.2.7.3.2 we shall see that the quantum anomaly cancellation for the closed *heterotic* superstring is analogously given by twisted string-structures, which follow the same general pattern of twisted \mathfrak{c} -structures, but in one degree higher.

But in general this quantum anomaly cancellation involves twists mediated by a higher rank twisted bundle. This situation we turn to now.

Definition 5.2.77. For X equipped with orientation structure o_X , def. 5.1.2, and $c \in \mathbf{H}(X, \mathbf{B}^2U(1))$ a twisting circle 2-bundle, we say that the 2-groupoid of *weakly c-twisted spin^c-structures* on X is $(W_3(o_X) - c)$ -twisted cohomology with respect to the morphism $\mathfrak{c} : \mathbf{B}PU \rightarrow \mathbf{B}^2U(1)$ discussed in 4.4.8.

Remark 5.2.78. By the discussion in 4.4.8 in weakly twisted spin^c -structure the two cocycles $W_3(o_X)$ and c are not equivalent, but their difference is an n -torsion class (for some n) in $H^3(X, \mathbb{Z})$ which twists a unitary rank- n vector bundle on X

Remark 5.2.79. By a refinement of the discussion of [FrWi99] in [Ka99] this structure is precisely what removes the quantum anomaly from the action functional of the type II superstring on oriented D-branes that carry a rank n Chan-Paton bundle. A review is in [La09].

Notice that for $i : Q \rightarrow X$ a Spin^c -D-brane inclusion into spacetimes X , the 2-groupoid of B -field and brane gauge field bundles is the *relative* $(\mathbf{BPU} \rightarrow \mathbf{B}^2U(1))$ -cohomology on i , according to def. 3.6.274.

5.2.7.3 Twisted differential string structures We consider now the obstruction theory for lifts through the smooth and differential refinement, from 5.1, of the Whitehead tower of O .

Definition 5.2.80. For X a Riemannian manifold, equipping it with

1. orientation
2. topological spin structure
3. topological string structure
4. topological fivebrane structure

means equipping it with choices of (homotopy classes of) lifts of the classifying map $TX : X \rightarrow BO$ of its tangent bundle through the respective steps of the Whitehead tower of BO

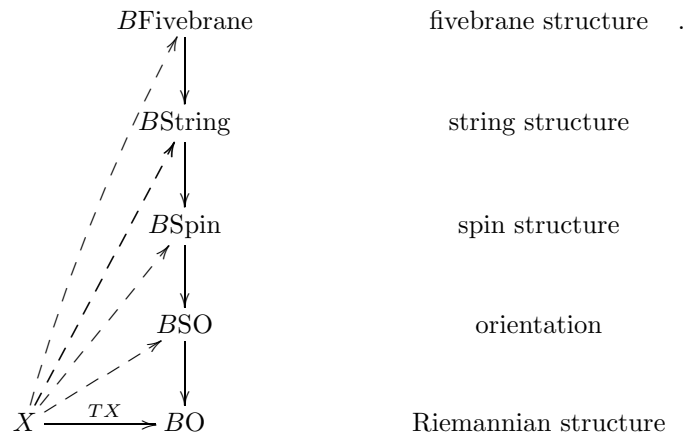

More in detail:

1. The set (homotopy 0-type) of orientations of a Riemannian manifold is the homotopy fiber of the first Stiefel-Whitney class

$$(w_1)_* : \text{Top}(X, BO) \rightarrow \text{Top}(X, B\mathbb{Z}_2).$$

2. The groupoid (homotopy 1-type) of topological spin structures of an oriented manifold is the homotopy fiber of the second Stiefel-Whitney class

$$(w_2)_* : \text{Top}(X, BSO) \rightarrow \text{Top}(X, B^2\mathbb{Z}_2).$$

3. The 3-groupoid (homotopy 3-type) of topological string structures of a spin manifold is the homotopy fiber of the first fractional Pontryagin class

$$\left(\frac{1}{2}p_1\right)_* : \text{Top}(X, B\text{Spin}) \rightarrow \text{Top}(X, B^4\mathbb{Z}),$$

4. The 7-groupoid (homotopy 7-type) of topological fivebrane structures of a string manifold is the homotopy fiber of the second fractional Pontryagin class

$$\left(\frac{1}{6}p_2\right)_* : \text{Top}(X, B\text{String}) \rightarrow \text{Top}(X, B^8\mathbb{Z}),$$

See [SSS09b] for background and the notion of fivebrane structure. Using the results of 5.1 we may lift this setup from discrete ∞ -groupoids to smooth ∞ -groupoids and discuss the twisted cohomology, 3.6.12, relative to the smooth fractional Pontryagin classes $\frac{1}{2}\mathbf{p}_1$ and $\frac{1}{6}\mathbf{p}_2$ and their differential refinements $\frac{1}{2}\hat{\mathbf{p}}_1$ and $\frac{1}{6}\hat{\mathbf{p}}_2$

Definition 5.2.81. Let $X \in \text{Smooth}\infty\text{Grpd}$ be any object.

1. The 2-groupoid of *smooth string structures* on X is the homotopy fiber of the lift of the first fractional Pontryagin class $\frac{1}{2}\mathbf{p}_1$ to $\text{Smooth}\infty\text{Grpd}$, prop. 5.1.9:

$$\mathbf{String}(X) \rightarrow \text{Smooth}\infty\text{Grpd}(X, \mathbf{BSpin}) \xrightarrow{(\frac{1}{2}\mathbf{p}_1)} \text{Smooth}\infty\text{Grpd}(X, \mathbf{B}^3U(1)).$$

2. The 6-groupoid of *smooth fivebrane structures* on X is the homotopy fiber of the lift of the second fractional Pontryagin class $\frac{1}{6}\mathbf{p}_2$ to $\text{Smooth}\infty\text{Grpd}$, prop. 5.1.32:

$$\mathbf{Fivebrane}(X) \rightarrow \text{Smooth}\infty\text{Grpd}(X, \mathbf{BString}) \xrightarrow{(\frac{1}{6}\mathbf{p}_2)} \text{Smooth}\infty\text{Grpd}(X, \mathbf{B}^7U(1)).$$

More generally,

1. The 2-groupoid of *smooth twisted string structures* on X is the ∞ -pullback

$$\begin{array}{ccc} \mathbf{String}_{\text{tw}}(X) & \xrightarrow{\text{tw}} & H^3_{\text{smooth}}(X, U(1)) \\ \downarrow & & \downarrow \\ \text{Smooth}\infty\text{Grpd}(X, \mathbf{BSpin})[r] & \xrightarrow{(\frac{1}{2}\mathbf{p}_1)} & \text{Smooth}\infty\text{Grpd}(X, \mathbf{B}^3U(1)) \end{array}$$

in ∞Grpd .

2. The 6-groupoid of *smooth twisted fivebrane structures* on X is the ∞ -pullback

$$\begin{array}{ccc} \mathbf{Fivebrane}_{\text{tw}}(X) & \xrightarrow{\text{tw}} & H^7_{\text{smooth}}(X, U(1)) \\ \downarrow & & \downarrow \\ \text{Smooth}\infty\text{Grpd}(X, \mathbf{BString})[r] & \xrightarrow{(\frac{1}{6}\hat{\mathbf{p}}_2)} & \text{Smooth}\infty\text{Grpd}(X, \mathbf{B}^7U(1)) \end{array}$$

in ∞Grpd .

Finally, with $\frac{1}{2}\hat{\mathbf{p}}_1$ and $\frac{1}{4}\hat{\mathbf{p}}_2$ the differential characteristic classes, 3.9.7, we set

1. The 2-groupoid of *smooth twisted differential string structures* on X is the ∞ -pullback

$$\begin{array}{ccc} \mathbf{String}_{\text{tw,diff}}(X) & \xrightarrow{\text{tw}} & H^4_{\text{diff}}(X) \\ \downarrow & & \downarrow \\ \text{Smooth}\infty\text{Grpd}(X, \mathbf{BSpin}_{\text{conn}})[r] & \xrightarrow{(\frac{1}{2}\hat{\mathbf{p}}_1)} & \text{Smooth}\infty\text{Grpd}(X, \mathbf{B}^3U(1)_{\text{conn}}) \end{array}$$

in ∞Grpd .

2. The 6-groupoid of *smooth twisted differential fivebrane structures* on X is the ∞ -pullback

$$\begin{array}{ccc} \mathbf{Fivebrane}_{\text{tw,diff}}(X) & \xrightarrow{\text{tw}} & H_{\text{diff}}^8(X) \\ \downarrow & & \downarrow \\ \text{Smooth}\infty\text{Grpd}(X, \mathbf{B}\text{String}_{\text{conn}}) & \xrightarrow{(\frac{1}{6}\hat{p}_2)} & \text{Smooth}\infty\text{Grpd}(X, \mathbf{B}^7U(1)_{\text{conn}}) \end{array}$$

in ∞Grpd .

The image of a twisted (differential) String/Fivebrane structure under tw is its *twist*. The restriction to twists whose underlying class vanishes we also call *geometric string structures* and *geometric fivebrane structures*.

Observation 5.2.82. 1. These ∞ -pullbacks are, up to equivalence, independent of the choice of the right vertical morphism, as long as this hits precisely one cocycle in each cohomology class.

2. The restriction of the n -groupoids of twisted structures to vanishing twist reproduces the untwisted structures.

The local L_∞ -algebra valued form data of differential twisted string- and fivebrane structures has been considered in [SSS09c], as we explain in 5.2.7.3.1. Differential string structures for twists with underlying trivial class (*geometric string structures*) have been considered in [Wal09] modeled on bundle 2-gerbes.

We have the following immediate consequences of the definition:

Observation 5.2.83. The spaces of choices of string structures extending a given spin structure S are as follows

- if $[\frac{1}{2}\mathbf{p}_1(S)] \neq 0$ it is empty: $\text{String}_S(X) \simeq \emptyset$;
- if $[\frac{1}{2}\mathbf{p}_1(S)] = 0$ it is $\text{String}_S(X) \simeq \mathbf{H}(X, \mathbf{B}^2U(1))$.

In particular the set of equivalence classes of string structures lifting S is the cohomology set

$$\pi_0\text{String}_S(X) \simeq H_{\text{Smooth}}^2(X, \mathbf{B}^2U(1)).$$

If X is a smooth manifold, then this is $\simeq H^3(X, \mathbb{Z})$.

Proof. Apply the pasting law for ∞ -pullbacks, prop. 2.3.2 on the diagram

$$\begin{array}{ccccc} \text{String}_S(X) & \longrightarrow & \text{String}(X) & \longrightarrow & * \\ \downarrow & & \downarrow & & \downarrow \\ * & \xrightarrow{S} & \mathbf{H}(X, \mathbf{B}\text{Spin}(n)) & \xrightarrow{\frac{1}{2}\mathbf{p}_1} & \mathbf{H}(X, \mathbf{B}^3U(1)) \end{array} .$$

The outer diagram defines the loop space object of $\mathbf{H}(X, \mathbf{B}^3U(1))$. Since $\mathbf{H}(X, -)$ commutes with forming loop space objects we have

$$\text{String}_S(X) \simeq \Omega\mathbf{H}(X, \mathbf{B}^3U(1)) \simeq \mathbf{H}(X, \mathbf{B}^2U(1)).$$

□

Sometimes it is useful to express string structures on X in terms of circle 2-bundles/bundle gerbes on the total space of the given spin bundle $P \rightarrow X$ [Redd06]:

Proposition 5.2.84. *A smooth string structure on X over a smooth Spin-principal bundle $P \rightarrow X$ induces a circle 2-bundle \hat{P} on P which restricted to any fiber $P_x \simeq \text{Spin}$ is equivalent to the String 2-group extension $\text{String} \rightarrow \text{Spin}$.*

Proof. By prop. 3.6.251. □

5.2.7.3.1 L_∞ -Čech cocycles for differential string structures We use the presentation of the ∞ -topos $\text{Smooth}\infty\text{Grpd}$ by the local model structure on simplicial presheaves $[\text{CartSp}_{\text{smooth}}^{\text{op}}, \text{sSet}]_{\text{proj}, \text{loc}}$ to give an explicit construction of twisted differential string structures in terms of Čech-cocycles with coefficients in L_∞ -algebra valued differential forms. We will find a twisted version of the **string-2**-connections discussed above in 1.2.8.7.2.

We need the following fact from [FSS10].

Proposition 5.2.85. *The differential fractional Pontryagin class $\frac{1}{2}\hat{\mathbf{P}}_1$ is presented in $[\text{CartSp}_{\text{smooth}}^{\text{op}}, \text{sSet}]_{\text{proj}}$ by the top morphism of simplicial presheaves in*

$$\begin{array}{ccc}
\text{cosk}_3 \exp(\mathfrak{so})_{\text{ChW, smp}} & \xrightarrow{\exp(\mu, \text{cs})} & \mathbf{B}^3\mathbb{R}/\mathbb{Z}_{\text{ChW, smp}} \\
\downarrow & & \downarrow \\
\text{cosk}_3 \exp(\mathfrak{so})_{\text{diff, smp}} & \xrightarrow{\exp(\mu, \text{cs})} & \mathbf{B}^3\mathbb{R}/\mathbb{Z}_{\text{smp}} \\
\downarrow \simeq & & \\
\mathbf{B}\text{Spin}_c & &
\end{array} .$$

Here the middle morphism is the direct Lie integration of the L_∞ -algebra cocycle, 4.4.14, while the top morphism is its restriction to coefficients for ∞ -connections, 4.4.17.

In order to compute the homotopy fibers of $\frac{1}{2}\hat{\mathbf{P}}_1$ we now find a resolution of this morphism $\exp(\mu, \text{cs})$ by a fibration in $[\text{CartSp}_{\text{smooth}}^{\text{op}}, \text{sSet}]_{\text{proj}}$. By the fact that this is a simplicial model category then also the hom of any cofibrant object into this morphism, computing the cocycle ∞ -groupoids, is a fibration, and therefore, by the general natur of homotopy pullbacks, we obtain the homotopy fibers as the ordinary fibers of this fibration.

We start by considering such a factorization before differential refinement, on the underlying characteristic class $\exp(\mu)$. To that end, we replace the Lie algebra $\mathfrak{g} = \mathfrak{so}$ by an equivalent but bigger Lie 3-algebra (following [SSS09c]). We need the following notation:

- $\mathfrak{g} = \mathfrak{so}$, the special orthogonal Lie algebra (the Lie algebra of the spin group);
- $b^2\mathbb{R}$, the line Lie 3-algebra, def. 4.4.61, the single generator in degree 3 of its Chevalley-Eilenberg algebra we denote $c \in CE(b^2\mathbb{R})$, $dc = 0$.
- $\langle -, - \rangle \in W(\mathfrak{g})$ is the Killing form invariant polynomial, regarded as an element of the Weil algebra of \mathfrak{so} ;
- $\mu := \langle -, [-, -] \rangle \in CE(\mathfrak{g})$, the degree 3 Lie algebra cocycle, identified with a morphism

$$CE(\mathfrak{g}) \leftarrow CE(b^2\mathbb{R}) : \mu$$

of Chevalley-Eilenberg algebras; and normalized such that its continuation to a 3-form on Spin is the image in de Rham cohomology of Spin of a generator of $H^3(\text{Spin}, \mathbb{Z}) \simeq \mathbb{Z}$;

- $\text{cs} \in W(\mathfrak{g})$ is a Chern-Simons element, def. 4.4.119, interpolating between the two;
- \mathfrak{g}_μ , the string Lie 2-algebra, def. 5.1.15.

Definition 5.2.86. Let $(b\mathbb{R} \rightarrow \mathfrak{g}_\mu)$ denote the L_∞ -algebra whose Chevalley-Eilenberg algebra is

$$CE(b\mathbb{R} \rightarrow \mathfrak{g}_\mu) = (\wedge^\bullet(\mathfrak{g}^* \oplus \langle b \rangle \oplus \langle c \rangle), d),$$

with b a generator in degree 2, and c a generator in degree 3, and with differential defined on generators by

$$\begin{aligned}
d|_{\mathfrak{g}^*} &= [-, -]^* \\
db &= -\mu + c. \\
dc &= 0
\end{aligned}$$

Observation 5.2.87. The 3-cocycle $\text{CE}(\mathfrak{g}) \xleftarrow{\mu} \text{CE}(b^2\mathbb{R})$ factors as

$$\text{CE}(\mathfrak{g}) \xleftarrow{(c \mapsto \mu, b \mapsto 0)} \text{CE}(b\mathbb{R} \rightarrow \mathfrak{g}) \xleftarrow{(c \mapsto c)} \text{CE}(\text{CE}(b^2\mathbb{R})) : \mu,$$

where the morphism on the left (which is the identity when restricted to \mathfrak{g}^* and acts on the new generators as indicated) is a quasi-isomorphism.

Proof. To see that we have a quasi-isomorphism, notice that the dg-algebra is somorphic to the one with generators $\{t^a, b, c'\}$ and differentials

$$\begin{aligned} d|_{\mathfrak{g}^*} &= [-, -]^* \\ db &= c' \\ dc' &= 0 \end{aligned},$$

where the isomorphism is given by the identity on the t^a s and on b and by

$$c \mapsto c' + \mu.$$

The primed dg-algebra is the tensor product $\text{CE}(\mathfrak{g}) \otimes \text{CE}(\text{inn}(b\mathbb{R}))$, where the second factor is manifestly cohomologically trivial. \square

The point of introducing the resolution $(b\mathbb{R} \rightarrow \mathfrak{g}_\mu)$ in the above way is that it naturally supports the obstruction theory of lifts from \mathfrak{g} -connections to string Lie 2-algebra 2-connections

Observation 5.2.88. The defining projection $\mathfrak{g}_\mu \rightarrow \mathfrak{g}$ factors through the above quasi-isomorphism $(b\mathbb{R} \rightarrow \mathfrak{g}_\mu) \rightarrow \mathfrak{g}$ by the canonical inclusion

$$\mathfrak{g}_\mu \rightarrow (b\mathbb{R} \rightarrow \mathfrak{g}_\mu),$$

which dually on CE -algebras is given by

$$\begin{aligned} t^a &\mapsto t^a \\ b &\mapsto -b \\ c &\mapsto 0. \end{aligned}$$

In total we are looking at a convenient presentation of the long fiber sequence of the string Lie 2-algebra extension:

$$\begin{array}{ccc} & (b\mathbb{R} \rightarrow \mathfrak{g}_\mu) & \longrightarrow b^2\mathbb{R} \\ & \nearrow & \downarrow \simeq \\ b\mathbb{R} & \longrightarrow \mathfrak{g}_\mu & \longrightarrow \mathfrak{g} \end{array}$$

(The signs appearing here are just unimportant convention made in order for some of the formulas below to come out nice.)

Proposition 5.2.89. *The image under Lie integration of the above factorization is*

$$\exp(\mu) : \mathbf{cosk}_3 \exp(\mathfrak{g}) \rightarrow \mathbf{cosk}_3 \exp(b\mathbb{R} \rightarrow \mathfrak{g}_\mu) \rightarrow \mathbf{B}^3\mathbb{R}/\mathbb{Z}_c$$

where the first morphism is a weak equivalence followed by a fibration in the model structure on simplicial presheaves $[\text{CartSp}_{\text{smooth}}^{\text{op}}, \text{sSet}]_{\text{proj}}$.

Proof. To see that the left morphism is objectwise a weak homotopy equivalence, notice that a $[k]$ -cell of $\exp(b\mathbb{R} \rightarrow \mathfrak{g}_\mu)$ is identified with a pair consisting of a based smooth function $f : \Delta^k \rightarrow \text{Spin}$ and a vertical 2-form $B \in \Omega_{\text{si,vert}}^2(U \times \Delta^k)$, (both suitably with sitting instants perpendicular to the boundary of the simplex). Since there is no further condition on the 2-form, it can always be extended from the boundary of the k -simplex to the interior (for instance simply by radially rescaling it smoothly to 0). Accordingly the

simplicial homotopy groups of $\exp(b\mathbb{R} \rightarrow \mathfrak{g}_\mu)(U)$ are the same as those of $\exp(\mathfrak{g})(U)$. The morphism between them is the identity in f and picks $B = 0$ and is hence clearly an isomorphism on homotopy groups.

We turn now to discussing that the second morphism is a fibration. The nontrivial degrees of the lifting problem

$$\begin{array}{ccc} \Lambda[k]_i & \longrightarrow & \exp(b\mathbb{R} \rightarrow \mathfrak{g}_\mu)(U) \\ \downarrow & & \downarrow \\ \Delta[k] & \longrightarrow & \mathbf{B}^3\mathbb{R}/\mathbb{Z}_c(U) \end{array}$$

are $k = 3$ and $k = 4$.

Notice that a 3-cell of $\mathbf{B}^3\mathbb{R}/\mathbb{Z}_c(U)$ is a smooth function $c : U \rightarrow \mathbb{R}/\mathbb{Z}$ and that the morphism $\exp(b\mathbb{R} \rightarrow \mathfrak{g}_\mu) \rightarrow \mathbf{B}^3\mathbb{R}/\mathbb{Z}_c$ sends the pair (f, B) to the fiber integration $\int_{\Delta^3} (f^* \langle \theta \wedge [\theta \wedge \theta] \rangle + dB)$.

Given our lifting problem in degree 3, we have given a function $c : U \rightarrow \mathbb{R}/\mathbb{Z}$ and a smooth function (with sitting instants at the subfaces) $U \times \Lambda_i^3 \rightarrow \text{Spin}$ together with a 2-form B on the horn $U \times \Lambda_i^3$.

By pullback along the standard continuous retract $\Delta^3 \rightarrow \Lambda_i^3$ which is non-smooth only where f has sitting instants, we can always extend f to a smooth function $f' : U \times \Delta^3 \rightarrow \text{Spin}$ with the property that $\int_{\Delta^3} (f')^* \langle \theta \wedge [\theta \wedge \theta] \rangle = 0$. (Following the general discussion at Lie integration.)

In order to find a horn filler for the 2-form component, consider any smooth 2-form with sitting instants and non-vanishing integral on Δ^2 , regarded as the missing face of the horn. By multiplying it with a suitable smooth function on U we can obtain an extension $\tilde{B} \in \Omega_{\text{si,vert}}^2(U \times \partial\Delta^3)$ of B to all of $U \times \partial\Delta^3$ with the property that its integral over $\partial\Delta^3$ is the given c . By Stokes' theorem it remains to extend \tilde{B} to the interior of Δ^3 in any way, as long as it is smooth and has sitting instants.

To that end, we can find in a similar fashion a smooth U -parameterized family of closed 3-forms C with sitting instants on Δ^3 , whose integral over Δ^3 equals c . Since by sitting instants this 3-form vanishes in a neighbourhood of the boundary, the standard formula for the Poincare lemma applied to it produces a 2-form $B' \in \Omega_{\text{si,vert}}^2(U \times \Delta^3)$ with $dB' = C$ that itself is radially constant at the boundary. By construction the difference $\tilde{B} - B'|_{\partial\Delta^3}$ has vanishing surface integral. By the argument in the proof of prop. 4.4.64 it follows that the difference extends smoothly and with sitting instants to a closed 2-form $\hat{B} \in \Omega_{\text{si,vert}}^2(U \times \Delta^3)$. Therefore the sum $B' + \hat{B} \in \Omega_{\text{si,vert}}^2(U \times \Delta^3)$ equals B when restricted to Λ_i^k and has the property that its integral over Δ^3 equals c . Together with our extension f' , this constitutes a pair that solves the lifting problem.

The extension problem in degree 4 amounts to a similar construction: by coskeletality the condition is that for a given $c : U \rightarrow \mathbb{R}/\mathbb{Z}$ and a given vertical 2-form on $U \times \partial\Delta^3$ such that its integral equals c , as well as a function $f : U \times \partial\Delta^3 \rightarrow \text{Spin}$, we can extend the 2-form and the function along $U \times \partial\Delta^3 \rightarrow U \times \Delta^3$. The latter follows from the fact that $\pi_2 \text{Spin} = 0$ which guarantees a continuous filler (with sitting instants), and using the Steenrod-Wockel approximation theorem [Wock09] to make this smooth. We are left with the problem of extending the 2-form, which is the same problem we discussed above after the choice of \tilde{B} . \square

We now proceed to extend this factorization to the exponentiated differential coefficients, 4.4.17. The direct idea would be to use the evident factorization of differential L_∞ -cocycles of the form

$$\begin{array}{ccccc} \text{CE}(\mathfrak{so}) & \longleftarrow & \text{CE}(b\mathbb{R} \rightarrow \mathfrak{string}) & \longleftarrow & \text{CE}(b^2\mathbb{R}) . \\ \uparrow & & \uparrow & & \uparrow \\ \text{W}(\mathfrak{so}) & \longleftarrow & \text{W}(b\mathbb{R} \rightarrow \mathfrak{string}) & \longleftarrow & \text{W}(b^2\mathbb{R}) \\ \uparrow & & \uparrow & & \uparrow \\ \text{inv}(\mathfrak{so}) & \longleftarrow & \text{inv}(b\mathbb{R} \rightarrow \mathfrak{string}) & \longleftarrow & \text{inv}(b^2\mathbb{R}) \end{array}$$

For computations we shall find it convenient to consider this after a change of basis.

Observation 5.2.90. The Weil algebra $W(b\mathbb{R} \rightarrow \mathfrak{g}_\mu)$ of $(b^2\mathbb{R} \rightarrow \mathfrak{g})$ is given on the extra shifted generators $\{r^a = \sigma t^a, h = \sigma b, g = \sigma c\}$ by

$$\begin{aligned} dt^a &= C^a_{bc} t^b \wedge t^c + r^a \\ dr^a &= -C^a_{bc} t^b \wedge r^a \\ db &= -\mu + c + h \\ dh &= \sigma\mu - g \\ dc &= g \end{aligned}$$

(where σ is the shift operator extended as a graded derivation).

Definition 5.2.91. Define $\tilde{W}(b\mathbb{R} \rightarrow \mathfrak{g}_\mu)$ to be the dg-algebra with the same underlying graded algebra as $W(b\mathbb{R} \rightarrow \mathfrak{g}_\mu)$ but with the differential modified as follows

$$\begin{aligned} dt^a &= C^a_{bc} t^b \wedge t^c + r^a \\ dr^a &= -C^a_{bc} t^b \wedge r^a \\ db &= -cs + c + h \\ dh &= \langle -, - \rangle - g \\ dc &= g \end{aligned}$$

Moreover, define $\tilde{\text{inv}}(b\mathbb{R} \rightarrow \mathbf{string})$ to be the dg-algebra

$$\tilde{\text{inv}}(b\mathbb{R} \rightarrow \mathbf{string}) := (\text{inv}(\mathfrak{so}) \otimes \langle g, h \rangle) / (dh = \langle -, - \rangle - g).$$

Observation 5.2.92. We have a commutative diagram of dg-algebras

$$\begin{array}{ccccc} \text{CE}(\mathfrak{so}) & \xleftarrow{\simeq} & \text{CE}(b\mathbb{R} \rightarrow \mathbf{string}) & \xleftarrow{\quad} & \text{CE}(b^2\mathbb{R}) \\ \uparrow & & \uparrow & & \uparrow \\ W(\mathfrak{so}) & \xleftarrow{\simeq} & \tilde{W}(b\mathbb{R} \rightarrow \mathbf{string}) & \xleftarrow{\quad} & W(b^2\mathbb{R}) \\ \uparrow & & \uparrow & & \uparrow \\ \text{inv}(\mathfrak{so}) & \xleftarrow{\simeq} & \tilde{\text{inv}}(b\mathbb{R} \rightarrow \mathbf{string}) & \xleftarrow{\quad} & \text{inv}(b^2\mathbb{R}) \end{array}$$

where $\tilde{W}(b\mathbb{R} \rightarrow \mathbf{string}) \rightarrow W(\mathfrak{so})$ acts as

$$\begin{aligned} t^a &\mapsto t^a \\ r^a &\mapsto r^a \\ b &\mapsto 0 \\ c &\mapsto cs \\ h &\mapsto 0 \\ g &\mapsto \langle -, - \rangle \end{aligned}$$

and we identify $W(b^2\mathbb{R}) = (\wedge^\bullet \langle c, g \rangle, dc = g)$. The left horizontal morphisms are quasi-isomorphisms, as indicated.

Definition 5.2.93. We write $\exp(b\mathbb{R} \rightarrow \mathbf{string})_{\text{ChW}}$ for the simplicial presheaf defined as $\exp(b\mathbb{R} \rightarrow \mathbf{string})_{\text{ChW}}$, but using $\text{CE}(b\mathbb{R} \rightarrow \mathbf{string}) \leftarrow \tilde{W}(b\mathbb{R} \rightarrow \mathbf{string}) \leftarrow \tilde{\text{inv}}(b\mathbb{R} \rightarrow \mathbf{string})$ instead of the untwiddled version of these algebras.

Proposition 5.2.94. Under differential Lie integration the above factorization, observation 5.2.92, maps to a factorization

$$\exp(\mu, cs) : \mathbf{cosk}_3 \exp(\mathfrak{g})_{\text{ChW}} \xrightarrow{\simeq} \mathbf{cosk}_3 \exp((b\mathbb{R} \rightarrow \mathfrak{g}_\mu))_{\text{ChW}} \rightarrow \mathbf{B}^3U(1)_{\text{ChW, ch}}$$

of $\exp(\mu, cs)$ in $[\text{CartSp}^{\text{op}}, \text{sSet}]_{\text{proj}}$, where the first morphism is a weak equivalence and the second a fibration.

Proof. We discuss that the first morphism is an equivalence. Clearly it is injective on homotopy groups: if a sphere of A -data cannot be filled, then also adding the (B, C) -data does not yield a filler. So we need to check that it is also surjective on homotopy groups: any two choices of (B, C) -data on a sphere are homotopic: we may interpolate B in any smooth way and then solve the equation $dB = -cs(A) + C + H$ for the interpolation of C .

We now check that the second morphism is a fibration. It is itself the composite

$$\mathbf{cosk}_3 \exp(b\mathbb{R} \rightarrow \mathfrak{g}_\mu)_{\text{ChW}} \rightarrow \exp(b^2\mathbb{R})_{\text{ChW}}/\mathbb{Z} \xrightarrow{f_{\Delta^\bullet}} \mathbf{B}^3\mathbb{R}/\mathbb{Z}_{\text{ChW, ch}}.$$

Here the second morphism is a degreewise surjection of simplicial abelian groups, hence a degreewise surjection under the normalized chain complex functor, hence is itself already a projective fibration. Therefore it is sufficient to show that the first morphism here is a fibration.

In degree $k = 0$ to $k = 3$ the lifting problems

$$\begin{array}{ccc} \Lambda[k]_i & \longrightarrow & \exp(b\mathbb{R} \rightarrow \mathfrak{g}_\mu)_{\text{ChW}}(U) \\ \downarrow & & \downarrow \\ \Delta[k] & \longrightarrow & \exp(b^2\mathbb{R})_{\text{ChW}}/\mathbb{Z}(U) \end{array}$$

may all be equivalently reformulated as lifting against a cylinder $D^k \hookrightarrow D^k \times [0, 1]$ by using the sitting instants of all forms.

We have then a 3-form $H \in \Omega_{\text{si}}^3(U \times D^{k-1} \times [0, 1])$ and differential form data (A, B, C) on $U \times D^{k-1}$ given. We may always extend A along the cylinder direction $[0, 1]$ (its vertical part is equivalently a based smooth function to Spin which we may extend constantly). H has to be horizontal so is already constantly extended along the cylinder.

We can then use the kind of formula that proves the Poincaré lemma to extend B . Let $\Psi : (D^k \times [0, 1]) \times [0, 1] \rightarrow (D^k \times [0, 1])$ be a smooth contraction. Then while $d(H - CS(A) - C)$ may be non-vanishing, by horizontality of their curvature characteristic forms we still have that $\iota_{\partial_t} \Psi_t^* d(H - CS(A) - C)$ vanishes (since the contraction vanishes).

Therefore the 2-form

$$\tilde{B} := \int_{[0,1]} \iota_{\partial_t} \Psi_t^* (H - CS(A) - C)$$

satisfies $d\tilde{B} = (H - CS(A) - C)$. It may however not coincide with our given B at $t = 0$. But the difference $B - \tilde{B}_{t=0}$ is a closed form on the left boundary of the cylinder. We may find some closed 2-form on the other boundary such that the integral around the boundary vanishes. Then the argument from the proof of the Lie integration of the line Lie n -algebra applies and we find an extension λ to a closed 2-form on the interior. The sum

$$\hat{B} := \tilde{B} + \lambda$$

then still satisfies $d\hat{B} = H - CS(A) - C$ and it coincides with B on the left boundary.

Notice that here \tilde{B} indeed has sitting instants: since H , $CS(A)$ and C have sitting instants they are constant on their value at the boundary in a neighbourhood perpendicular to the boundary, which means for these 3-forms in the degrees ≤ 3 that they *vanish* in a neighbourhood of the boundary, hence that the above integral is towards the boundary over a vanishing integrand.

In degree 4 the nature of the lifting problem

$$\begin{array}{ccc} \Lambda[4]_i & \longrightarrow & \mathbf{cosk}_3 \exp(b\mathbb{R} \rightarrow \mathfrak{g}_\mu)(U) \\ \downarrow & & \downarrow \\ \Delta[4] & \longrightarrow & \mathbf{B}^3\mathbb{R}/\mathbb{Z}_{\text{ChW, ch}} \end{array}$$

starts out differently, due to the presence of \mathbf{cosk}_3 , but it then ends up amounting to the same kind of argument:

We have four functions $U \rightarrow \mathbb{R}/\mathbb{Z}$ which we may realize as the fiber integration of a 3-form H on $U \times (\partial\Delta[4] \setminus \delta_i\Delta[3])$, and we have a lift to (A, B, C, H) -data on $U \times (\partial\Delta[4] \setminus \delta_i(\Delta[3]))$ (the boundary of the 4-simplex minus one of its 3-simplex faces).

We observe that we can

- always extend C smoothly to the remaining 3-face such that its fiber integration there reproduces the signed difference of the four given functions corresponding to the other faces (choose any smooth 3-form with sitting instants and with non-vanishing integral and rescale smoothly);
- fill the A -data horizontally due to the fact that $\pi_2(\text{Spin}) = 0$.
- the C -form is already horizontal, hence already filled.

Moreover, by the fact that the 2-form B already is defined on all of $\partial\Delta[4] \setminus \delta_i(\Delta[3])$ its fiber integral over the boundary $\partial\Delta[3]$ coincides with the fiber integral of $H - \text{cs}(A) - C$ over $\partial\Delta[4] \setminus \delta_i(\Delta[3])$. But by the fact that we have lifted C and the fact that $\mu(A_{\text{vert}}) = \text{cs}(A)|_{\Delta^3}$ is an integral cocycle, it follows that this equals the fiber integral of $C - \text{cs}(A)$ over the remaining face.

Use then as above the vertical Poincaré lemma-formula to find \tilde{B} on $U \times \Delta^3$ with sitting instants that satisfies the equation $d\tilde{B} = H - \text{cs}(A) - C$ there. Then extend the closed difference $B - \tilde{B}|_0$ to a closed smooth 2-form on Δ^3 . As before, the difference

$$\hat{B} := \tilde{B} + \lambda$$

is an extension of B that constitutes a lift. □

Corollary 5.2.95. *For any $X \in \text{SmoothMfd} \leftrightarrow \text{Smooth}\infty\text{Grpd}$, for any choice of differentiably good open cover with corresponding cofibrant presentation $\hat{X} = C(\{C_i\}) \in [\text{CartSp}_{\text{smooth}}^{\text{op}}, \text{sSet}]_{\text{proj}}$ we have that the 2-groupoids of twisted differential string structures are presented by the ordinary fibers of the morphism of Kan complexes*

$$\begin{aligned} & [\text{CartSp}^{\text{op}}, \text{sSet}](\hat{X}, \exp(\mu, \text{cs})) \\ & [\text{CartSp}^{\text{op}}, \text{sSet}](\hat{X}, \mathbf{cosk}_3 \exp(b\mathbb{R} \rightarrow \mathfrak{g}_\mu)_{\text{ChW}}) \rightarrow [\text{CartSp}^{\text{op}}, \text{sSet}](\hat{X}, \mathbf{B}^3U(1)_{\text{ChW}}). \end{aligned}$$

over any basepoints in the connected components of the Kan complex on the right, which correspond to the elements $[\hat{C}_3] \in H_{\text{diff}}^4(X)$ in the ordinary differential cohomology of X .

Proof. Since $[\text{CartSp}_{\text{smooth}}^{\text{op}}, \text{sSet}]_{\text{proj}}$ is a simplicial model category the morphism $[\text{CartSp}^{\text{op}}, \text{sSet}](\hat{X}, \exp(\mu, \text{cs}))$ is a fibration because $\exp(\mu, \text{cs})$ is and \hat{X} is cofibrant.

It follows from the general theory of homotopy pullbacks that the ordinary pullback of simplicial presheaves

$$\begin{array}{ccc} \mathbf{String}_{\text{diff}, \text{tw}}(X) & \longrightarrow & H_{\text{diff}}^4(X) \\ \downarrow & & \downarrow \\ [\text{CartSp}^{\text{op}}, \text{sSet}](\hat{X}, \mathbf{cosk}_3 \exp(b\mathbb{R} \rightarrow \mathfrak{g}_\mu)_{\text{ChW}}) & \longrightarrow & [\text{CartSp}^{\text{op}}, \text{sSet}](\hat{X}, \mathbf{B}^3U(1)_{\text{ChW}}) \end{array}$$

is a presentation for the defining ∞ -pullback for $\mathbf{String}_{\text{diff}, \text{tw}}(X)$. □

We unwind the explicit expression for a twisted differential string structure under this equivalence. Any twisting cocycle is in the above presentation given by a Čech-Deligne-cocycle, as discussed at 4.4.16.

$$\hat{\mathbf{H}}_3 = ((H_3)_i, \dots)$$

with local connection 3-form $(H_3)_i \in \Omega^3(U_i)$ and globally defined curvature 4-form $\mathcal{G}_4 \in \Omega^4(X)$.

Observation 5.2.96. A twisted differential string structure on X , twisted by this cocycle, is on patches U_i a morphism

$$\Omega^\bullet(U_i) \leftarrow \tilde{W}(b\mathbb{R} \rightarrow \mathfrak{g}_\mu)$$

in dgAlg , subject to some horizontality constraints. The components of this are over each U_i a collection of differential forms of the following structure

$$\left(\begin{array}{l} F_\omega = d\omega + \frac{1}{2}[\omega \wedge \omega] \\ H_3 = \nabla B := dB + CS(\omega) - C_3 \\ \mathcal{G}_4 = dC_3 \\ dF_\omega = -[\omega \wedge F_\omega] \\ dH_3 = \mathcal{G}_4 - \langle F_\omega \wedge F_\omega \rangle \\ d\mathcal{G}_4 = 0 \end{array} \right)_i \quad \longleftarrow \quad \begin{array}{l} t^a \mapsto \omega^a \\ r^a \mapsto F_\omega^a \\ b \mapsto B \\ c \mapsto C_3 \\ h \mapsto H_3 \\ g \mapsto \mathcal{G}_4 \end{array} \quad \left(\begin{array}{l} r^a = dt^a + \frac{1}{2}C^a_{bc}t^b \wedge t^c \\ h = db + cs - c \\ g = dc \\ dr^a = -C^a_{bc}t^b \wedge r^a \\ dh = \langle -, - \rangle - g \\ dg = 0 \end{array} \right).$$

Here we are indicating on the right the generators and their relation in $\tilde{W}(b\mathbb{R} \rightarrow \mathfrak{g}_\mu)$ and on the left their images and the images of the relations in $\Omega^\bullet(U_i)$. This are first the definitions of the curvatures themselves and then the Bianchi identities satisfied by these.

By prop. 4.4.127 we have that for \mathfrak{g} an L_∞ -algebra and

$$\mathbf{BG} := \mathbf{cosk}_{n+1} \exp(\mathfrak{g})$$

the delooping of the smooth Lie n -group obtained from it by Lie integration, def. 4.4.56 the coefficient for ∞ -connections on G -principal ∞ -bundles is

$$\mathbf{BG}_{\text{conn}} := \mathbf{cosk}_{n+1} \exp(\mathfrak{g})_{\text{conn}}.$$

Proposition 5.2.97. *The 2-groupoid of entirely untwisted differential string structures, def. 5.2.81, on X (the twist being $0 \in H^4_{\text{diff}}(X)$) is equivalent to that of principal 2-bundles with 2-connection over the string 2-group, def. 5.1.10, as discussed in 1.2.8.7.2:*

$$\text{String}_{\text{diff}, \text{tw}=0}(X) \simeq \text{String2Bund}_\nabla(X).$$

Proof. By 5.2.7.3.1 we compute $\text{String}_{\text{diff}, \text{tw}=0}(X)$ as the ordinary fiber of the morphism of simplicial presheaves

$$[\text{CartSp}^{\text{op}}, \text{sSet}](C(\{U_i\}), \mathbf{cosk}_3 \exp(b\mathbb{R} \rightarrow \mathfrak{g}_\mu)) \rightarrow [\text{CartSp}^{\text{op}}, \text{sSet}](C(\{U_i\}), \mathbf{B}^3U(1)_{\text{diff}})$$

over the identically vanishing cocycle.

In terms of the component formulas of observation 5.2.96, this amounts to restricting to those cocycles for which over each $U \times \Delta^k$ the equations

$$C = 0$$

$$G = 0$$

hold. Comparing this to the explicit formulas for $\exp(b\mathbb{R} \rightarrow \mathfrak{g}_\mu)$ and $\exp(b\mathbb{R} \rightarrow \mathfrak{g}_\mu)_{\text{conn}}$ in 5.2.7.3.1 we see that these cocycles are exactly those that factor through the canonical inclusion

$$\mathfrak{g}_\mu \rightarrow (b\mathbb{R} \rightarrow \mathfrak{g}_\mu)$$

from observation 5.2.88. □

5.2.7.3.2 The Green-Schwarz mechanism in heterotic supergravity Local differential form data as in observation 5.2.96 is known in theoretical physics in the context of the Green-Schwarz mechanism for 10-dimensional supergravity. We conclude with some comments on the meaning and application of this result (for background and references on the physics story see for instance [SSS09b]).

The standard action functionals of higher dimensional supergravity theories are generically *anomalous* in that instead of being functions on the space of field configurations, they are just sections of a line bundle over these spaces. In order to get a well defined action principle as input for a path-integral quantization to obtain the corresponding quantum field theories, one needs to prescribe in addition the data of a *quantum integrand*. This is a choice of trivialization of these line bundles, together with a choice of flat connection. For this to be possible the line bundle has to be trivialisable and flat in the first place. Its failure to be trivialisable – its Chern class – is called the *global anomaly*, and its failure to be flat – its curvature 2-form – is called its local anomaly.

But moreover, the line bundle in question is the tensor product of two different line bundles with connection. One is a Pfaffian line bundle induced from the fermionic degrees of freedom of the theory, the other is a line bundle induced from the higher form fields of the theory in the presence of higher *electric and magnetic charge*. The Pfaffian line bundle is fixed by the requirement of supersymmetry, but there is freedom in choosing the background higher electric and magnetic charge. Choosing these appropriately such as to ensure that the tensor product of the two anomaly line bundles produces a flat trivialisable line bundle is called an *anomaly cancellation* by a *Green-Schwarz mechanism*.

Concretely, the higher gauge background field of 10-dimensional heterotic supergravity is the Kalb-Ramond field, which in the absence of *fivebrane magnetic charge* is modeled by a circle 2-bundle (bundle gerbe) with connection and curvature 3-form $H_3 \in \Omega_{\text{cl}}^3(X)$, satisfying the higher *Maxwell equation*

$$dH_3 = 0.$$

Notice that we may think of a circle 2-bundle as a homotopy from the trivial circle 3-bundle to itself.

In order to cancel the relevant quantum anomaly it turns out that a magnetic background charge density is to be added to the system whose differential form representative is the difference $j_{\text{mag}} := \langle F_{\nabla_{\text{SU}}} \wedge F_{\nabla_{\text{SU}}} \rangle - \langle F_{\nabla_{\text{Spin}}} \wedge F_{\nabla_{\text{Spin}}} \rangle$ between the Pontryagin forms of the Spin-tangent bundle and a given SU-gauge bundle. This modifies the above Maxwell equation locally, on a patch $U_i \subset X$ to

$$dH_i = \langle F_{A_i} \wedge F_{A_i} \rangle - \langle F_{\omega_i} \wedge F_{\omega_i} \rangle.$$

Comparing with prop. 5.2.96 and identifying the curvature of the twist with $\mathcal{G}_4 = \langle F_{A_i} \wedge F_{A_i} \rangle$ we see that, while such H_i can no longer be the curvature 3-form of a circle 2-bundle, it can be the local 3-form component of a *twisted* circle 3-bundle that is part of the data of a twisted differential string-structure. The above differential form equation exhibits a de Rham homotopy between the two Pontryagin forms. This is the local differential aspect of the very definition of a twisted differential string-structure: a homotopy from the Chern-Simons circle 3-bundle of the Spin-tangent bundle to a given twisting circle 3-bundle.

For many years the anomaly cancellation for the heterotic superstring was known at the level of precision used in the physics community, based on a seminal article by Killingback. Recently [Bun09] has given a rigorous proof in the special case that underlying topological class of the twisting gauge bundle is trivial. This proof used the model of twisted differential string structures with topologically trivial twist given in [Wal09]. This model is explicitly constructed in terms of bundle 2-gerbes and does not exhibit the homotopy pullback property of def. 3.9.8 explicitly. However, the author shows that his model satisfies the abstract properties following from the universal property of the homotopy pullback.

When we take into account also gauge transformations of the gauge bundle, we should replace the homotopy pullback defining twisted differential string structures this by the full homotopy pullback

$$\begin{array}{ccc} \text{GSBackground}(X) & \longrightarrow & \mathbf{H}_{\text{conn}}(X, \mathbf{BU}) \quad . \\ \downarrow & & \downarrow \hat{c}_2 \\ \mathbf{H}_{\text{conn}}(X, \mathbf{BSpin}) & \xrightarrow{\frac{1}{2}\hat{P}_1} & \mathbf{H}_{\text{dR}}(X, \mathbf{B}^3U(1)) \end{array}$$

The look of this diagram makes manifest how in this situation we are looking at the structures that homotopically cancel the differential classes $\frac{1}{2}\hat{\mathbf{p}}$ and $\hat{\mathbf{c}}_2$ against each other.

Since $\mathbf{H}_{dR}(X, \mathbf{B}^3U(1))$ is abelian, we may also consider the corresponding Mayer-Vietoris sequence by realizing $\text{GSBackground}(X)$ equivalently as the homotopy fiber of the difference of differential cocycles $\frac{1}{2}\hat{\mathbf{p}}_1 - \hat{\mathbf{c}}_2$.

$$\begin{array}{ccc}
 \text{GSBackground}(X) & \longrightarrow & * \\
 \downarrow & & \downarrow \\
 \mathbf{H}_{\text{conn}}(X, \mathbf{B}\text{Spin} \times \mathbf{B}U) & \xrightarrow{\frac{1}{2}\hat{\mathbf{p}}_1 - \hat{\mathbf{c}}_2} & \mathbf{H}_{dR}(X, \mathbf{B}^4U(1))
 \end{array}$$

5.2.8 Classical supergravity

Action functionals of *supergravity* are extensions to super-geometry, 4.6, of the *Einstein-Hilbert action functional* that models the physics of *gravity*. While these action functionals are not themselves, generally, of higher Chern-Simons type, 3.9.11, or of higher Wess-Zumino-Witten type, 3.9.12, some of them are low-energy effective actions of *super string field theory* action functionals, that are of this type, as we discuss below in 5.5.10. Accordingly, supergravity action functionals typically exhibit rich Chern-Simons-like substructures.

A traditional introduction to the general topic can be found in [DeMo99]. A textbook that aims for a more systematic formalization is [CaDAFr91]. Below in 5.2.8.4 we observe that the discussion of supergravity there is secretly in terms of ∞ -connections, 1.2.8.6, with values in super L_∞ -algebras, 4.6.4.

- 5.2.8.1 – First-order/gauge theory formulation of gravity
- 5.2.8.2 – Higher extensions of the super Poincaré Lie algebra;
- 5.2.8.4 – Supergravity fields are super L_∞ -connections

Much of this discussion we re-encounter when we consider super-Minkowski spacetime as a target space for higher WZW models below in 5.6.4.

5.2.8.1 First-order/gauge theory formulation of gravity The field theory of gravity (“general relativity”) has a natural *first order formulation* where a field configuration over a given $(d + 1)$ -dimensional manifold X is given by a $\mathfrak{iso}(d, 1)$ -valued Cartan connection, def. 4.5.57. The following statements briefly review this and related facts (see for instance also the review in the introduction of [Zan05]).

Definition 5.2.98. For $d \in \mathbb{N}$, the *Poincaré group* $\text{ISO}(d, 1)$ is the group of auto-isometries of the Minkowski space $\mathbb{R}^{d,1}$ equipped with its canonical pseudo-Riemannian metric η .

This is naturally a Lie group. Its Lie algebra is the *Poincaré Lie algebra* $\mathfrak{iso}(d, 1)$.

We recall some standard facts about the Poincaré group.

Observation 5.2.99. The Poncaré group is the semidirect product

$$\text{ISO}(d, 1) \simeq \text{O}(d, 1) \ltimes \mathbb{R}^{d+1}$$

of the *Lorentz group* $\text{O}(d, 1)$ of *linear* auto-isometries of $\mathbb{R}^{d,1}$, and the abelian translation group in $(d + 1)$ dimensions, with respect to the defining action of $\text{O}(d, 1)$ on $\mathbb{R}^{d,1}$. Accordingly there is a canonical embedding of Lie groups

$$\text{O}(d, 1) \hookrightarrow \text{ISO}(d, 1)$$

and the corresponding coset space is Minkowski space

$$\text{ISO}(d, 1)/\text{O}(d, 1) \simeq \mathbb{R}^{d,1} .,$$

Analogously the Poincaré Lie algebra is the semidirect product

$$\mathfrak{iso}(d, 1) \simeq \mathfrak{so}(d, 1) \ltimes \mathbb{R}^{d,1} ,$$

Accordingly there is a canonical embedding of Lie algebras

$$\mathfrak{so}(d, 1) \hookrightarrow \mathfrak{iso}(d, 1)$$

and the corresponding quotient of vector spaces is Minkowski space

$$\mathfrak{iso}(d, 1)/\mathfrak{so}(d, 1) \simeq \mathbb{R}^{d,1} .$$

Minkowski space $\mathbb{R}^{d,1}$ is the local model for *Lorentzian manifolds*.

Definition 5.2.100. A *Lorentzian manifold* is a pseudo-Riemannian manifold (X, g) such that each tangent space $(T_x X, g_x)$ for any $x \in X$ is isometric to a Minkowski space $(\mathbb{R}^{d,1}, \eta)$.

Proposition 5.2.101. *Equivalence classes of $(O(d,1) \hookrightarrow \text{ISO}(d,1))$ -valued Cartan connections, def. 4.5.57, on a smooth manifold X are in canonical bijection with Lorentzian manifold structures on X .*

This follows from the following observations.

Observation 5.2.102. Locally over a patch $U \rightarrow X$ a $\mathfrak{iso}(d,1)$ connection is given by a 1-form

$$A = (E, \Omega) \in \Omega^1(U, \mathfrak{iso}(d,1))$$

with a component

$$E \in \Omega^1(U, \mathbb{R}^{d+1})$$

and a component

$$\Omega \in \Omega^1(U, \mathfrak{so}(d,1)).$$

If this comes from a $(O(d,1) \rightarrow \text{ISO}(d,1))$ -Cartan connection then E is non-degenerate in that for all $x \in X$ the induced linear map

$$E : T_x X \rightarrow \mathbb{R}^{d+1}$$

is a linear isomorphism. In this case X is equipped with the Lorentzian metric

$$g := E^* \eta$$

and Ω is naturally identified with a compatible metric connection on TX . Then curvature 2-form of the connection

$$F_A = (F_\Omega, F_E) \in \Omega^2(U, \mathfrak{iso}(d,1))$$

has as components the *Riemann curvature*

$$F_\Omega = d\Omega + \frac{1}{2}[\Omega \wedge \Omega] \in \Omega^2(U, \mathfrak{so}(d,1))$$

of the metric connection, as well as the *torsion*

$$F_E = dE + [\Omega \wedge E] \in \Omega^2(U, \mathbb{R}^{d,1}).$$

Therefore precisely if in addition the torsion vanishes is Ω uniquely fixed to be the Levi-Civita connection on (X, g) .

Therefore the configuration space of gravity on a smooth manifold X may be identified with the moduli space of $\mathfrak{iso}(d,1)$ -valued Cartan connections on X . The field content of *supergravity* is obtained from this by passing from the to Poincaré Lie algebra to one of its *super Lie algebra extensions*, a *super Poincaré Lie algebra*.

There are different such extensions. All involve some spinor representation of the Lorentz Lie algebra $\mathfrak{so}(d,1)$ as odd-degree elements in the super Lie algebra. The choice of number N of irreps in this representation. But there are in general more choices, given by certain exceptional *polyvector extensions* of such super-Poincaré-Lie algebras which contain also new even-graded elements.

Below we show that these Lie superalgebra polyvector extensions, in turn, are induced from canonical *super L_∞ -algebra extensions* given by exceptional super Lie algebra cocycles, and that the configuration spaces of higher dimensional supergravity may be identified with moduli spaces of ∞ -connections, 1.2.8, with values in a super L_∞ -algebra, def. 4.6.14. that arise as higher central extensions, def. 4.4.105, of a super Poincaré Lie algebra.

5.2.8.2 L_∞ -extensions of the super Poincaré Lie algebra The super-Poincaré Lie algebra is the local gauge algebra of supergravity. It inherits the cohomology of the special orthogonal or Lorentz Lie algebra $\mathfrak{so}(d, 1)$, but crucially it exhibits a finite number of exceptional $\mathfrak{so}(d, 1)$ -invariant cocycles on its super-translation algebra. The super L_∞ -algebra extensions induced by these cocycles control the structure of higher dimensional supergravity fields as well as of super- p -brane σ -models that propagate in a supergravity background.

- 5.2.8.3 – The super Poincaré Lie algebra;
- 5.2.8.3.1 – M2-brane Lie 3-algebra and the M-theory Lie algebra;
- 5.2.8.3.2 – Exceptional cocycles and the brane scan.

5.2.8.3 The super Poincaré Lie algebra

Definition 5.2.103. For $n \in \mathbb{N}$ and S a spinor representation of $\mathfrak{so}(n, 1)$, the corresponding *super Poincaré Lie algebra* $\mathfrak{S}\mathfrak{I}\mathfrak{so}(n, 1)$ is the super Lie algebra whose Chevalley-Eilenberg algebra $\text{CE}(\mathfrak{S}\mathfrak{I}\mathfrak{so}(10, 1))$ is generated from

1. generators $\{\omega^{ab}\}$ in degree (1, even) dual to the standard basis of $\mathfrak{so}(n, 1)$,
2. generators $\{e^a\}$ in degree (1, even)
3. and generators $\{\psi^\alpha\}$ in degree (1, odd), dual to the spinor representation S

with differential defined by

$$\begin{aligned} d_{\text{CE}}\omega^a{}_b &= \omega^a{}_c \wedge \omega^c{}_d \\ d_{\text{CE}}e^a &= \omega^a{}_b \wedge e^b + \frac{i}{2}\bar{\psi} \wedge \Gamma^a\psi \\ d_{\text{CE}}\psi &= \frac{1}{4}\omega^{ab}\Gamma_{ab}\psi, \end{aligned}$$

where $\{\Gamma^a\}$ is the corresponding representation of the Clifford algebra $\text{Cl}_{n,1}$ on S , and here and in the following $\Gamma^{a_1 \dots a_k}$ is shorthand for the skew-symmetrization of the matrix product $\Gamma^{a_1} \dots \Gamma^{a_k}$ in the k indices.

5.2.8.3.1 M2-brane Lie 3-algebra and the M-theory Lie algebra We discuss an exceptional extension of the super Poincaré Lie algebra in 11-dimensions by a super Lie 3-algebra and further by super Lie 6-algebra. We show that the corresponding automorphism L_∞ -algebra contains the polyvector extension called the *M-theory super Lie algebra*.

Proposition 5.2.104. For $(n, 1) = (10, 1)$ and S the canonical spinor representation, we have an exceptional super Lie algebra cohomology class in degree 4

$$[\mu_4] \in H^{2,2}(\mathfrak{S}\mathfrak{I}\mathfrak{so}(10, 1))$$

with a representative given by

$$\mu_4 := \frac{1}{2}\bar{\psi} \wedge \Gamma^{ab}\psi \wedge e_a \wedge e_b.$$

This is due to [dAFr82].

Definition 5.2.105. The *M2-brane super Lie 3-algebra* $\mathfrak{m2branc}_{\text{gs}}$ is the $b\mathbb{R}$ -extension of $\mathfrak{S}\mathfrak{I}\mathfrak{so}(10, 1)$ classified by μ_4 , according to prop. 4.4.110

$$b^2\mathbb{R} \rightarrow \mathfrak{m2branc}_{\text{gs}} \rightarrow \mathfrak{siso}(10, 1).$$

In terms of its Chevalley-Eilenberg algebra this extension was first considered in [dAFr82].

Definition 5.2.106. The *polyvector extension* [ACDP03] of $\mathfrak{s}\mathcal{I}\mathfrak{so}(10, 1)$ – called the *M-theory Lie algebra* – is the super Lie algebra obtained by adjoining to $\mathfrak{s}\mathcal{I}\mathfrak{so}(10, 1)$ generators $\{Q_\alpha, Z^{ab}\}$ that transform as spinors with respect to the existing generators, and whose non-vanishing brackets among themselves are

$$\begin{aligned} [Q_\alpha, Q_\beta] &= i(C\Gamma^a)_{\alpha\beta} P_a + (C\Gamma_{ab}) Z^{ab} \\ [Q_\alpha, Z^{ab}] &= 2i(C\Gamma^{[a})_{\alpha\beta} Q^{b]\beta}. \end{aligned}$$

Proposition 5.2.107. *The automorphism super L_∞ -algebra $\text{Det}(\mathfrak{m}2\text{brane}_{\text{gs}})$, def. 1.2.149, contains the polyvector extension of the 11d-super Poincaré algebra, def. 5.6.34 precisely as its graded Lie algebra of exact elements.*

Proof. One can see that this is secretly what [Ca95] shows. □

Proposition 5.2.108. *There is a nontrivial degree-7 class $[\mu_7] \in H^{5,2}(\mathfrak{m}2\text{brane}_{\text{gs}})$ in the super- L_∞ -algebra cohomology of the M2-brane Lie 3-algebra, a cocycle representative of which is*

$$\mu_7 := -\frac{1}{2}\bar{\psi} \wedge \Gamma^{a_1 \dots a_5} \psi \wedge e_{a_1} \wedge \dots \wedge e_{a_5} - \frac{13}{2}\bar{\psi} \wedge \Gamma^{a_1 a_2} \psi \wedge e_{a_1} \wedge e_{s_2} \wedge c_3,$$

where c_3 is the extra generator of degree 3 in $\text{CE}(\mathfrak{m}2\text{brane}_{\text{gs}})$.

This is due to [dAFr82].

Definition 5.2.109. The *M5-brane Lie 6-algebra* $\mathfrak{m}5\text{brane}_{\text{gs}}$ is the $b^5\mathbb{R}$ -extension of $\mathfrak{m}2\text{brane}_{\text{gs}}$ classified by μ_7 , according to prop. 4.4.110

$$b^5\mathbb{R} \rightarrow \mathfrak{m}5\text{brane}_{\text{gs}} \rightarrow \mathfrak{m}2\text{brane}_{\text{gs}}.$$

5.2.8.3.2 Exceptional cocycles and the brane scan The exceptional cocycles discussed above are part of a pattern which traditionally goes by the name *brane scan* [Duf87].

Proposition 5.2.110. *For $d, p \in \mathbb{N}$, let $\mathfrak{s}\mathcal{I}\mathfrak{so}(d, 1)$ be the super Poincaré Lie algebra, def. 5.2.103, and consider the element*

$$\bar{\psi} \Gamma_{a_0, \dots, a_{p+1}} \wedge \psi \wedge e^{a_0} \wedge \dots \wedge e^{a_{p+1}} \in \text{CE}(\mathfrak{s}\mathcal{I}\mathfrak{so}(d, 1))$$

in degree $p + 2$ of the Chevalley-Eilenberg algebra. This is closed, hence is a cocycle, for the combinations of $D := d + 1$ and $p \geq 1$ precisely where there are non-empty and non-parenthesis entries in the following table.

	$p = 1$	2	3	4	5
$D = 11$		$\mathfrak{m}2\text{brane}_{\text{gs}}$			$(\mathfrak{m}5\text{brane}_{\text{gs}})$
10	$\text{string}_{\text{gs}}$				$\text{ns}5\text{brane}_{\text{gs}}$
9				*	
8			*		
7		*			
6	*		*		
5		*			
4	*	*			
3	*				

The entries in the top two rows are labeled by the name of the extension of $\mathfrak{s}\mathcal{I}\mathfrak{so}(d, 1)$ that the corresponding cocycle classifies. By prop. 5.2.105 the 7-cocycle that defines $\mathfrak{m}5\text{brane}_{\text{gs}}$ does not live on the Lie algebra $\mathfrak{s}\mathcal{I}\mathfrak{so}(10, 1)$, but only on its Lie 3-algebra extension $\mathfrak{m}2\text{brane}_{\text{gs}}$. This is why in the context of the brane scan it does not appear in the classical literature, which does not know about higher Lie algebras.

An explicitly Lie-theoretic discussion of these cocycles is in chapter 8 of [AzIz95]. The extension

$$b\mathbb{R} \rightarrow \text{string}_{\text{gs}} \rightarrow \mathfrak{s}\mathcal{I}\mathfrak{so}(9, 1)$$

and its Lie integration has been considered in [Huer11].

5.2.8.4 Supergravity fields are super L_∞ -connections Among the varied literature in theoretical physics on the topic of *supergravity* the book [CaDAFr91] and the research program that it summarizes, starting with [dAFr82], stands out as an attempt to identify and make use of a systematic mathematical structure controlling the general theory. By careful comparison one can see that the notions considered in that book may be translated into notions considered here under the following dictionary

- “FDA”: the Chevalley-Eilenberg algebra $\text{CE}(\mathfrak{g})$ of a super L_∞ -algebra \mathfrak{g} (def. 4.6.14), def. 4.5.12;
- “soft group manifold”: the Weil algebra $W(\mathfrak{g})$ of \mathfrak{g} , def. 4.4.107
- “field configuration”: \mathfrak{g} -valued ∞ -connection, def. 1.2.8.6
- “field strength”: curvature of \mathfrak{g} -valued ∞ -connection, def. 1.2.169
- “horizontal condition”: second ∞ -Ehresmann condition, remark 1.2.178
- “cosmo-cocycle condition”: characterization of \mathfrak{g} -Chern-Simons elements, def. 4.4.119, to first order in the curvatures;

All the super L_∞ -algebras \mathfrak{g} appearing in [CaDAFr91] are higher shifted central extensions, in the sense of prop. 4.4.110, of the super-Poincaré Lie algebra.

5.2.8.4.1 The graviton and the gravitino

Example 5.2.111. For X a supermanifold and $\mathfrak{g} = \mathfrak{S}\mathfrak{I}\mathfrak{S}\mathfrak{o}(n, 1)$ the super Poincaré Lie algebra from def. 5.2.103, \mathfrak{g} -valued differential form data

$$A : TX \rightarrow \mathfrak{S}\mathfrak{I}\mathfrak{S}\mathfrak{o}(n, 1)$$

consists of

1. an \mathbb{R}^{n+1} -valued even 1-form $E \in \Omega^1(X, \mathbb{R}^{n+1})$ – the *vielbein*, identified as the propagating part of the *graviton* field;
2. an $\mathfrak{so}(n, 1)$ -valued even 1-form $\Omega \in \Omega^1(X, \mathfrak{so}(n, 1))$ – the *spin connection*, identified as the non-propagating auxiliary part of the graviton field;
3. a spin-representaton -valued odd 1-form $\Psi \in \Omega^1(X, S)$ – identified as the *gravitino field*.

5.2.8.4.2 The 11d supergravity C_3 -field

Example 5.2.112. For $\mathfrak{g} = \mathfrak{m}2\mathfrak{b}\mathfrak{r}\mathfrak{a}\mathfrak{n}\mathfrak{c}_{\mathfrak{g}\mathfrak{s}}$ the Lie 3-algebra from def. 5.2.105, a \mathfrak{g} -valued form

$$A : TX \rightarrow \mathfrak{sugra}_3(10, 1)$$

consists in addition to the field content of a $\mathfrak{S}\mathfrak{I}\mathfrak{S}\mathfrak{o}(10, 1)$ -connection from example 5.2.111 of

- a 3-form $C_3 \in \Omega^3(X)$.

This 3-form field is the local incarnation of what is called the *supergravity C_3 -field*. The global nature of this field is discussed in 5.2.9.

5.2.8.4.3 The magnetic dual 11d supergravity C_6 -field

Example 5.2.113. For $\mathfrak{g} = \mathfrak{m}5\mathfrak{b}\mathfrak{r}\mathfrak{a}\mathfrak{n}\mathfrak{c}_{\mathfrak{g}\mathfrak{s}}$ the 11d-supergravity Lie 6-algebra, def. 5.2.109, a \mathfrak{g} -valued form

$$A : TX \rightarrow \mathfrak{sugra}_6(10, 1)$$

consists in addition to the field content of a $\mathfrak{sugra}_3(10, 1)$ -connection given in remark 5.2.112 of

- a 6-form $C_6 \in \Omega^3(X)$ – the dual *supergravity C -field*.

The identification of this field content is also due to the analysis of [dAFr82].

5.2.9 The supergravity C -field

We consider a slight variant of twisted differential \mathbf{c} -structures, where instead of having the twist directly in differential cohomology, it is instead first considered just in de Rham cohomology but then supplemented by a lift of the structure ∞ -group.

We observe that when such a twist is by the sum of the first fractional Pontryagin class with the second Chern class, and when the second of these two steps is considered over the boundary of the base manifold, then the differential structures obtained this way exhibit some properties that a differential cohomological description of the C_3 -field in *11-dimensional supergravity*, 5.2.8.4.2, is expected to have.

This section draws from [FSS12a] and [FSS12b].

The supergravity C -field is subject to a certain \mathbb{Z}_2 -twist [Wi96] [Wi97a], due to a quadratic refinement of its action functional, which we review below in 5.2.9.1. A formalization of this twist in abelian differential cohomology for fixed background spin structure has been given in [HoSi05], in terms of *differential integral Wu structures*. These we review in 5.2.9.2 and refine them from \mathbb{Z}_2 -coefficients to circle n -bundles. Then we present a natural moduli 3-stack of C -field configurations that refines this model to nonabelian differential cohomology, generalizing it to dynamical gravitational background fields, in 5.2.9.4. We discuss a natural boundary coupling of these fields to E_8 -gauge fields in 5.2.9.6.

5.2.9.1 Higher abelian Chern-Simons theories with background charge The supergravity C -field is an example of a general phenomenon of higher abelian Chern-Simons QFTs in the presence of *background charge*. This phenomenon was originally noticed in [Wi96] and then made precise in [HoSi05]. The holographic dual of this phenomenon is that of self-dual higher gauge theories, which for the supergravity C -field is the nonabelian 2-form theory on the M5-brane [FSS12b]. We review the idea in a way that will smoothly lead over to our refinements to nonabelian higher gauge theory in section 5.2.9.

Fix some natural number $k \in \mathbb{N}$ and an oriented manifold (compact with boundary) X of dimension $4k + 3$. The gauge equivalence class of a $(2k + 1)$ -form gauge field \hat{G} on X is an element in the differential cohomology group $\hat{H}^{2k+2}(X)$. The cup product $\hat{G} \cup \hat{G} \in \hat{H}^{4k+4}(X)$ of this with itself has a natural higher holonomy over X , denoted

$$\begin{aligned} \exp(iS(-)) : \hat{H}^{2k+2}(X) &\rightarrow U(1) \\ \hat{G} &\mapsto \exp\left(i \int_X \hat{G} \cup \hat{G}\right). \end{aligned}$$

This is the exponentiated action functional for bare $(4k + 3)$ -dimensional abelian Chern-Simons theory. For $k = 0$ this reduces to ordinary 3-dimensional abelian Chern-Simons theory. Notice that, even in this case, this is a bit more subtle than Chern-Simons theory for a simply-connected gauge group G . In the latter case all fields can be assumed to be globally defined forms. But in the non-simply-connected case of $U(1)$, instead the fields are in general cocycles in differential cohomology. If, however, we restrict attention to fields C in the inclusion $H_{\text{dR}}^{2k+1}(X) \hookrightarrow \hat{H}^{2k+2}(X)$, then on these the above action reduces to the familiar expression

$$\exp(iS(C)) = \exp\left(i \int_X C \wedge d_{\text{dR}} C\right).$$

Observe now that the above action functional may be regarded as a *quadratic form* on the group $\hat{H}^{2k+2}(X)$. The corresponding bilinear form is the (“secondary”, since X is of dimension $4k + 3$ instead of $4k + 4$) *intersection pairing*

$$\begin{aligned} \langle -, - \rangle : \hat{H}^{2k+2}(X) \times \hat{H}^{2k+2}(X) &\rightarrow U(1) \\ (\hat{a}_1, \hat{a}_2) &\mapsto \exp\left(i \int_X \hat{a}_1 \cup \hat{a}_2\right). \end{aligned}$$

But note that from $\exp(iS(-))$ we do *not* obtain a *quadratic refinement* of the pairing. A quadratic refinement is, by definition, a function

$$q : \hat{H}^{2k+2}(X) \rightarrow U(1)$$

(not necessarily homogenous of degree 2 as $\exp(iS(-))$ is), for which the intersection pairing is obtained via the polarization formula

$$\langle \hat{a}_1, \hat{a}_2 \rangle = q(\hat{a}_1 + \hat{a}_2)q(\hat{a}_1)^{-1}q(\hat{a}_2)^{-1}q(0).$$

If we took $q := \exp(iS(-))$, then the above formula would yield not $\langle -, - \rangle$, but the square $\langle -, - \rangle^2$, given by the exponentiation of *twice* the integral.

The observation in [Wi96] was that for the correct holographic physics, we need instead an action functional which is indeed a genuine quadratic refinement of the intersection pairing. But since the differential classes in $\hat{H}^{2k+2}(X)$ refine *integral* cohomology, we cannot in general simply divide by 2 and pass from $\exp(i \int_X \hat{G} \cup \hat{G})$ to $\exp(i \int_X \frac{1}{2} \hat{G} \cup \hat{G})$. The integrand in the latter expression does not make sense in general in differential cohomology. If one tried to write it out in the “obvious” local formulas one would find that it is a functional on fields which is not gauge invariant. The analog of this fact is familiar from nonabelian G -Chern-Simons theory with simply-connected G , where also the theory is consistent only at interger *levels*. The “level” here is nothing but the underlying integral class $G \cup G$. Therefore the only way to obtain a square root of the quadratic form $\exp(iS(-))$ is to *shift it*. Here we think of the analogy with a quadratic form

$$q : x \mapsto x^2$$

on the real numbers (a parabola in the plane). Replacing this by

$$q^\lambda : x \mapsto x^2 - \lambda x$$

for some real number λ means keeping the shape of the form, but shifting its minimum from 0 to $\frac{1}{2}\lambda$. If we think of this as the potential term for a scalar field x then its ground state is now at $x = \frac{1}{2}\lambda$. We may say that there is a *background field* or *background charge* that pushes the field out of its free equilibrium.

To lift this reasoning to our action quadratic form $\exp(iS(-))$ on differential cocycles, we need a differential class $\hat{\lambda} \in H^{2k+2}(X)$ such that for every $\hat{a} \in H^{2k+2}(X)$ the composite class

$$\hat{a} \cup \hat{a} - \hat{a} \cup \hat{\lambda} \in H^{4k+4}(X)$$

is even, hence is divisible by 2. Because then we could define a shifted action functional

$$\exp(iS^\lambda(-)) : \hat{a} \mapsto \exp\left(i \int_X \frac{1}{2}(\hat{a} \cup \hat{a} - \hat{a} \cup \hat{\lambda})\right),$$

where now the fraction $\frac{1}{2}$ in the integrand does make sense. One directly sees that if this exists, then this shifted action is indeed a quadratic refinement of the intersection pairing:

$$\exp(iS^\lambda(\hat{a} + \hat{b})) \exp(iS^\lambda(\hat{a}))^{-1} \exp(iS^\lambda(\hat{b}))^{-1} \exp(iS^\lambda(0)) = \exp(i \int_X \hat{a} \cup \hat{b}).$$

The condition on the existence of $\hat{\lambda}$ here means, equivalently, that the image of the underlying integral class vanishes under the map

$$(-)_{\mathbb{Z}_2} : H^{2k+2}(X, \mathbb{Z}) \rightarrow H^{2k+2}(X, \mathbb{Z}_2)$$

to \mathbb{Z}_2 -cohomology:

$$(a)_{\mathbb{Z}_2} \cup (a)_{\mathbb{Z}_2} - (a)_{\mathbb{Z}_2} \cup (\lambda)_{\mathbb{Z}_2} = 0 \in H^{4k+4}(X, \mathbb{Z}_2).$$

Precisely such a class $(\lambda)_{\mathbb{Z}_2}$ does uniquely exist on every oriented manifold. It is called the *Wu class* $\nu_{2k+2} \in H^{2k+2}(X, \mathbb{Z}_2)$, and may be *defined* by this condition. Moreover, if X is a Spin-manifold, then every second Wu class, ν_{4k} , has a pre-image in integral cohomology, hence λ does exist as required above

$$(\lambda)_{\mathbb{Z}_2} = \nu_{2k+2}.$$

It is given by polynomials in the Pontrjagin classes of X (discussed in section E.1 of [HoSi05]). For instance the degree-4 Wu class (for $k = 1$) is refined by the first fractional Pontrjagin class $\frac{1}{2}p_1$

$$(\frac{1}{2}p_1)_{\mathbb{Z}_2} = \nu_4 .$$

In the present context, this was observed in [Wi96] (see around eq. (3.3) there).

Notice that the equations of motion of the shifted action $\exp(iS^\lambda(\hat{a}))$ are no longer $\text{curv}(\hat{a}) = 0$, but are now

$$\text{curv}(\hat{a}) = \frac{1}{2}\text{curv}(\hat{\lambda}) .$$

We therefore think of $\exp(iS^\lambda(-))$ as the exponentiated action functional for *higher dimensional abelian Chern-Simons theory with background charge $\frac{1}{2}\lambda$* .

With respect to the shifted action functional it makes sense to introduce the shifted field

$$\hat{G} := \hat{a} - \frac{1}{2}\hat{\lambda} .$$

This is simply a re-parameterization such that the Chern-Simons equations of motion again look homogenous, namely $G = 0$. In terms of this shifted field the action $\exp(iS^\lambda(\hat{a}))$ from above equivalently reads

$$\exp(iS^\lambda(\hat{G})) = \exp(i \int_X \frac{1}{2}(\hat{G} \cup \hat{G} - (\frac{1}{2}\hat{\lambda})^2)) .$$

For the case $k = 1$, this is the form of the action functional for the 7d Chern-Simons dual of the 2-form gauge field on the 5-brane first given as (3.6) in [Wi96]

In the language of twisted cohomological structures, def. 3.9.61, we may summarize this situation as follows: *In order for the action functional of higher abelian Chern-Simons theory to be correctly divisible, the images of the fields in \mathbb{Z}_2 -cohomology need to form a twisted Wu-structure, [Sa11b]. Therefore the fields themselves need to constitute a twisted λ -structure. For $k = 1$ this is a twisted String-structure [SSS09c] and explains the quantization condition on the C-field in 11-dimensional supergravity.*

In [HoSi05] a formalization of the above situation has been given in terms of a notion there called *differential integral Wu structures*. In the following section we explain how this follows from the notion of twisted Wu structures with the twist taken in \mathbb{Z}_2 -coefficients. Then we refine this to a formalization to *twisted differential Wu structures* with the twist taken in smooth circle n -bundles.

5.2.9.2 Differential integral Wu structures We discuss some general aspects of smooth and differential refinements of \mathbb{Z}_2 -valued universal characteristic classes. For the special case of *Wu classes* we show how these notions reduce to the definition of *differential integral Wu structures* given in [HoSi05]. We then construct a refinement of these structures that lifts the twist from \mathbb{Z}_2 -valued cocycles to smooth circle n -bundles. This further refinement of integral Wu structures is what underlies the model for the supergravity C-field in section 5.2.9.

Recall from prop. 5.1.37 the characterization of Spin^c as the loop space object of the homotopy pullback

$$\begin{array}{ccc} \mathbf{BSpin}^c & \longrightarrow & \mathbf{BU}(1) \\ \downarrow & & \downarrow c_1 \text{ mod } 2 \\ \mathbf{BSO} & \xrightarrow{w_2} & \mathbf{B}^2\mathbb{Z}_2 \end{array} .$$

For general $n \in \mathbb{N}$ the analog of the first Chern class mod 2 appearing here is the higher Dixmier-Douady class mod 2

$$\mathbf{DD}_{\text{mod } 2} : \mathbf{B}^n U(1) \xrightarrow{\text{DD}} \mathbf{B}^{n+1} \mathbb{Z} \xrightarrow{\text{mod } 2} \mathbf{B}^{n+1} \mathbb{Z}_2 .$$

Let now

$$\nu_{n+1} : \mathbf{BSO} \rightarrow \mathbf{B}^{n+1} \mathbb{Z}_2$$

be a representative of the universal smooth *Wu class* in degree $n+1$, the $(\Pi \dashv \text{Disc})$ -adjunct of the topological universal Wu class using that $\mathbf{B}^{n+1}\mathbb{Z}$ is discrete as a smooth ∞ -groupoid, and using that $\Pi(\mathbf{BSO}) \simeq BSO$ is the ordinary classifying space, by prop. 4.3.30.

Definition 5.2.114. Let $\text{Spin}^{\nu_{n+1}}$ be the loop space object of the homotopy pullback

$$\begin{array}{ccc} \mathbf{BSpin}^{\nu_{n+1}} & \longrightarrow & \mathbf{BSO} \\ \downarrow \nu_{n+1}^{\text{int}} & & \downarrow \nu_{n+1} \\ \mathbf{B}^n U(1) & \xrightarrow{\text{mod } 2} & \mathbf{B}^{n+1} \mathbb{Z}_2 \end{array} .$$

We call the left vertical morphism ν_{n+1} appearing here the *universal smooth integral Wu structure* in degree $n+1$.

A morphism of stacks

$$\nu_{n+1} : X \rightarrow \mathbf{BSpin}^{\nu_{n+1}}$$

is a choice of orientation structure on X together with a choice of smooth integral Wu structure lifting the corresponding Wu class ν_{n+1} .

Example 5.2.115. The smooth first fractional Pontrjagin class $\frac{1}{2}\mathbf{p}_2$, prop. 5.1.5, fits into a diagram

$$\begin{array}{ccc} \mathbf{BSpin} & \xrightarrow{\quad} & \mathbf{BSO} \\ \downarrow \frac{1}{2}\mathbf{p}_1 & \searrow u & \downarrow \nu_4 \\ \mathbf{B}^3 U(1) & \xrightarrow{\text{mod } 2} & \mathbf{B}^4 \mathbb{Z}_2 \\ \downarrow \nu_4^{\text{int}} & & \downarrow \nu_4 \\ \mathbf{BSpin}^{\nu_4} & \longrightarrow & \mathbf{BSO} \end{array} .$$

In this sense we may think of $\frac{1}{2}\mathbf{p}_1$ as being the integral and, moreover, smooth refinement of the universal degree-4 Wu class on \mathbf{BSpin} .

Proof. Using the defining property of $\frac{1}{2}\mathbf{p}_1$, this follows with the results discussed in appendix E.1 of [HoSi05]. \square

Proposition 5.2.116. Let X be a smooth manifold equipped with orientation

$$o_X : X \rightarrow \mathbf{BSO}$$

and consider its Wu-class $[\nu_{n+1}(o_X)] \in H^{n+1}(X, \mathbb{Z}_2)$

$$\nu_{n+1}(o_X) : X \xrightarrow{o_X} \mathbf{BSO} \xrightarrow{\nu_{n+1}} \mathbf{B}^{n+1} \mathbb{Z}_2 .$$

The n -groupoid $\widehat{\mathbf{DD}}_{\text{mod } 2} \text{Struc}_{[\nu_{2k}]}(X)$ of $[\nu_{n+1}]$ -twisted differential $\mathbf{DD}_{\text{mod } 2}$ -structures, according to def. 3.9.61, hence the homotopy pullback

$$\begin{array}{ccc} \widehat{\mathbf{DD}}_{\text{mod } 2} \text{Struc}_{[\nu_{n+1}]}(X) & \longrightarrow & * \\ \downarrow & & \downarrow \nu_{n+1}(o_X) \\ \mathbf{H}(X, \mathbf{B}^3 U(1)_{\text{conn}}) & \xrightarrow{\widehat{\mathbf{DD}}_{\text{mod } 2}} & \mathbf{H}(X, \mathbf{B}^{n+1} \mathbb{Z}_2) \end{array} ,$$

categorifies the groupoid $\widehat{\mathcal{H}}_{\nu_{n+1}}^{n+1}(X)$ of differential integral Wu structures as in def. 2.12 of [HoSi05]: its 1-truncation is equivalent to the groupoid defined there

$$\tau_1 \widehat{\mathbf{DD}}_{\text{mod } 2} \text{Struc}_{[\nu_{n+1}]}(X) \simeq \widehat{\mathcal{H}}_{\nu_{n+1}}^{n+1}(X) .$$

Proof. By prop. 4.4.91, the canonical presentation of $\mathbf{DD}_{\text{mod}2}$ via the Dold-Kan correspondence is given by an epimorphism of chain complexes of sheaves, hence by a fibration in $[\text{CartSp}^{\text{op}}, \text{sSet}]_{\text{proj}}$. Precisely, the composite

$$\hat{\mathbf{D}}\mathbf{D}_{\text{mod}2} : \mathbf{B}^n U(1)_{\text{conn}} \longrightarrow \mathbf{B}^n U(1) \xrightarrow{\text{DD}} \mathbf{B}^{n+1} \mathbb{Z} \xrightarrow{\text{mod}2} \mathbf{B}^{n+1} \mathbb{Z}_2$$

is presented by the vertical sequence of morphisms of chain complexes

$$\begin{array}{ccccccc} \mathbb{Z}^{\mathbb{C}} & \longrightarrow & C^\infty(-, \mathbb{R}) & \xrightarrow{d_{\text{dR}} \log} & \Omega^1(-) & \xrightarrow{d_{\text{dR}}} & \cdots & \xrightarrow{d_{\text{dR}}} & \Omega^n(-) \\ \downarrow & & \downarrow & & \downarrow & & & & \downarrow \\ \mathbb{Z}^{\mathbb{C}} & \longrightarrow & C^\infty(-, \mathbb{R}) & \longrightarrow & 0 & \longrightarrow & \cdots & \longrightarrow & 0 \\ \downarrow & & \downarrow & & \downarrow & & & & \downarrow \\ \mathbb{Z} & \longrightarrow & 0 & \longrightarrow & 0 & \longrightarrow & \cdots & \longrightarrow & 0 \\ \downarrow & & \downarrow & & \downarrow & & & & \downarrow \\ \mathbb{Z}_2 & \longrightarrow & 0 & \longrightarrow & 0 & \longrightarrow & \cdots & \longrightarrow & 0 \end{array} .$$

By remark 2.3.14 we may therefore compute the defining homotopy pullback for $\hat{\mathbf{D}}\mathbf{D}_{\text{mod}2} \text{Struct}_{[\nu_{n+1}]}(X)$ as an ordinary fiber product of the corresponding simplicial sets of cocycles. The claim then follows by inspection. \square

Remark 5.2.117. Explicitly, a cocycle in $\tau_1 \hat{\mathbf{D}}\mathbf{D}_{\text{mod}2} \text{Struct}_{[\nu_{n+1}]}(X)$ is identified with a Čech cocycle with coefficients in the Deligne complex

$$(\mathbb{Z}^{\mathbb{C}} \longrightarrow C^\infty(-, \mathbb{R}) \xrightarrow{d_{\text{dR}} \log} \Omega^1(-) \xrightarrow{d_{\text{dR}}} \cdots \xrightarrow{d_{\text{dR}}} \Omega^n(-))$$

such that the underlying $\mathbb{Z}[n+1]$ -valued cocycle modulo 2 equals the given cocycle for ν_{n+1} . A coboundary between two such cocycles is a gauge equivalence class of ordinary Čech-Deligne cocycles such that their underlying \mathbb{Z} -cocycle vanishes modulo 2. Cocycles of this form are precisely those that arise by multiplication with 2 or arbitrary Čech-Deligne cocycles.

This is the groupoid structure discussed on p. 14 of [HoSi05], there in terms of singular instead of Čech cohomology.

We now consider another twisted differential structure, which refines these twisting integral Wu structures to *smooth* integral Wu structures, def. 5.2.114.

Definition 5.2.118. For $n \in \mathbb{N}$, write $\mathbf{B}^n U(1)_{\text{conn}}^{\nu_{n+1}}$ for the homotopy pullback of smooth moduli n -stacks

$$\begin{array}{ccc} \mathbf{B}^n U(1)_{\text{conn}}^{\nu_{n+1}} & \longrightarrow & \mathbf{B}^n U(1)_{\text{conn}} \\ \downarrow & & \downarrow \\ \mathbf{B}\text{Spin}^{\nu_{n+1}} \times \mathbf{B}^n U(1) & \xrightarrow{\nu_{n+1}^{\text{int}} - 2\mathbf{DD}} & \mathbf{B}^n U(1) \end{array} ,$$

where ν_{n+1}^{int} is the universal smooth integral Wu class from def. 5.2.114, and where $2\mathbf{DD} : \mathbf{B}^n U(1) \rightarrow \mathbf{B}^n U(1)$ is the canonical smooth refinement of the operation of multiplication by 2 on integral cohomology.

We call this the moduli n -stack of *smooth differential Wu-structures*.

By construction, a morphism $X \rightarrow \mathbf{B}^n U(1)_{\text{conn}}^{\nu_{n+1}}$ classifies also all possible orientation structures and smooth integral lifts of their Wu structures. In applications one typically wants to fix an integral Wu structure lifting a given Wu class. This is naturally formalized by the following construction.

Definition 5.2.119. For X an oriented manifold, and

$$\nu_{n+1} : X \rightarrow \mathbf{BSpin}^{\nu_{n+1}}$$

a given smooth integral Wu structure, def. 5.2.114, write $\mathbf{H}_{\nu_{n+1}}(X, \mathbf{B}^n U(1)_{\text{conn}}^{\nu_{n+1}})$ for the n -groupoid of cocycles whose underlying smooth integral Wu structure is ν_{n+1} , hence for the homotopy pullback

$$\begin{array}{ccc} \mathbf{H}_{\nu_{n+1}}(X, \mathbf{B}^n U(1)_{\text{conn}}^{\nu_{n+1}}) & \longrightarrow & \mathbf{H}(X, \mathbf{B}^n U(1)_{\text{conn}}^{\nu_{n+1}}) \\ \downarrow & & \downarrow \\ \mathbf{H}(X, \mathbf{B}^n U(1)) & \xrightarrow{(\nu_{n+1}, \text{id})} & \mathbf{H}(X, \mathbf{BSpin}^{\nu_{n+1}} \times \mathbf{B}^n U(1)) \\ \downarrow & & \downarrow \\ * & \xrightarrow{\nu_{n+1}} & \mathbf{H}(X, \mathbf{BSpin}^{\nu_{n+1}}) \end{array} .$$

Proposition 5.2.120. Cohomology with coefficients in $\mathbf{B}^n U(1)_{\text{conn}}^{\nu_{n+1}}$ over a given smooth integral Wu structure coincides with the corresponding differential integral Wu structures:

$$\hat{H}_{\nu_{n+1}}^{n+1}(X) \simeq H_{\nu_{n+1}}(X, \mathbf{B}^n U(1)_{\text{conn}}^{\nu_{n+1}}).$$

Proof. Let $C(\{U_i\})$ be the Čech-nerve of a good open cover of X . By prop. 4.4.91 the canonical presentation of $\mathbf{B}^n U(1)_{\text{conn}} \rightarrow \mathbf{B}^n U(1)$ is a projective fibration. Since $C(\{U_i\})$ is projectively cofibrant and $[\text{CartSp}^{\text{op}}, \text{sSet}]_{\text{proj}}$ is a simplicial model category, the morphism of Čech cocycle simplicial sets

$$[\text{CartSp}^{\text{op}}, \text{sSet}](C(\{U_i\}), \mathbf{B}^n U(1)_{\text{conn}}) \rightarrow [\text{CartSp}^{\text{op}}, \text{sSet}](C(\{U_i\}), \mathbf{B}^n U(1))$$

is a Kan fibration. Hence, by remark 2.3.14, its homotopy pullback may be computed as the ordinary pullback of simplicial sets of this map. The claim then follows by inspection.

Explicitly, in this presentation a cocycle in the pullback is a pair (a, \hat{G}) of a cocycle a for a circle n -bundle and a Deligne cocycle \hat{G} with underlying bare cocycle G , such that there is an equality of degree- n Čech $U(1)$ -cocycles

$$G = \nu_{n+1} - 2a.$$

A gauge transformation between two such cocycles is a pair of Čech cochains $\hat{\gamma}, \alpha$ such that $\gamma = 2\alpha$ (the cocycle ν_{n+1} being held fixed). This means that the gauge transformations acting on a given \hat{G} solving the above constraint are precisely the all Deligne cocychains, but multiplied by 2. This is again the explicit description of $\hat{H}_{\nu_{n+1}}(X)$ from remark 5.2.117. \square

5.2.9.3 Twisted differential $\text{String}(E_8)$ -structures We discuss smooth and differential refinements of the canonical degree-4 universal characteristic class

$$a : BE_8 \rightarrow K(\mathbb{Z}, 4)$$

for E_8 the largest of the exceptional semisimple Lie algebras.

Proposition 5.2.121. There exists a differential refinement of the canonical integral 4-class on BE_8 to the smooth moduli stack of E_8 -connections with values in the smooth moduli 3-stack of circle 3-bundles with 3-connection

$$\hat{a} : (\mathbf{B}E_8)_{\text{conn}} \longrightarrow \mathbf{B}^3 U(1)_{\text{conn}} .$$

Using the L_∞ -algebraic data provided in [SSS09a], this was constructed in [FSS10].

Proposition 5.2.122. *Under geometric realization, prop. 3.8.2, the smooth class \mathbf{a} becomes an equivalence*

$$|\mathbf{a}| : BE_8 \simeq_{16} B^3U(1) \simeq K(\mathbb{Z}, 4)$$

on 16-coskeleta.

Proof. By [BoSa58] the 15-coskeleton of the topological space E_8 is a $K(\mathbb{Z}, 4)$. By [FSS10], \mathbf{a} is a smooth refinement of the generator $[a] \in H^4(BE_8, \mathbb{Z})$. By the Hurewicz theorem this is identified with $\pi_4(BE_8) \simeq \mathbb{Z}$. Hence in cohomology \mathbf{a} induces an isomorphism

$$\pi_4(BE_8) \simeq [S^4, BE_8] \simeq H^1(S^4, E_8) \xrightarrow{|\mathbf{a}|} H^4(S^4, \mathbb{Z}) \simeq [S^4, K(\mathbb{Z}, 4)] \simeq \pi_4(S^4) .$$

Therefore $|\mathbf{a}|$ is a weak homotopy equivalence on 16 coskeleta. \square

5.2.9.4 The moduli 3-stack of the C -field As we have reviewed above in section 5.2.9.1, the flux quantization condition for the C -field derived in [Wi97a] is the equation

$$[G_4] = \frac{1}{2}p_1 \pmod{2} \text{ in } H^4(X, \mathbb{Z}) \tag{5.16}$$

in integral cohomology, where $[G_4]$ is the cohomology class of the C -field itself, and $\frac{1}{2}p_1$ is the first fractional Pontrjagin class of the Spin manifold X . One can equivalently rewrite (5.16) as

$$[G_4] = \frac{1}{2}p_1 + 2a \text{ in } H^4(X, \mathbb{Z}), \tag{5.17}$$

where a is some degree 4 integral cohomology class on X . By the discussion in section 5.2.9.2, the correct formalization of this for *fixed* spin structure is to regard the gauge equivalence class of the C -field as a differential integral Wu class relative to the integral Wu class $\nu_4^{\text{int}} = \frac{1}{2}p_1$, example 5.2.115, of that spin structure. By prop. 5.2.120 and prop. 5.1.9, the natural refinement of this to a smooth moduli 3-stack of C -field configurations and arbitrary spin connections is the homotopy pullback of smooth 3-stacks

$$\begin{array}{ccc} \mathbf{B}^nU(1)_{\text{conn}}^{\nu_{n+1}} & \longrightarrow & \mathbf{B}^3U(1)_{\text{conn}} \\ \downarrow & & \downarrow \\ \mathbf{B}\text{Spin}_{\text{conn}} \times \mathbf{B}^3U(1) & \xrightarrow{\frac{1}{2}\hat{p}_1 + 2\text{DD}} & \mathbf{B}^3U(1) \end{array} .$$

Here the moduli stack in the bottom left is that of the field of gravity (spin connections) together with an auxiliary circle 3-bundle / 2-gerbe. Following the arguments in [FSS12b] (the traditional ones as well as the new ones presented there), we take this auxiliary circle 3-bundle to be the Chern-Simons circle 3-bundle of an E_8 -principal bundle. According to prop. 5.2.121 this is formalized on smooth higher moduli stacks by further pulling back along the smooth refinement

$$\mathbf{a} : \mathbf{B}E_8 \rightarrow \mathbf{B}^3U(1)$$

of the canonical universal 4-class $[a] \in H^4(BE_8, \mathbb{Z})$. Therefore we are led to formalize the E_8 -model for the C -field as follows.

Definition 5.2.123. The *smooth moduli 3-stack of spin connections and C -field configurations* in the E_8 -model is the homotopy pullback \mathbf{CField} of the moduli n -stack of smooth differential Wu structures

$\mathbf{B}^n U(1)_{\text{conn}}^{\nu_4}$, def. 5.2.118, to spin connections and E_8 -instanton configurations, hence the homotopy pull-back

$$\begin{array}{ccc} \mathbf{CField} & \longrightarrow & \mathbf{B}^3 U(1)_{\text{conn}}^{\nu_4} \\ \downarrow & & \downarrow \\ \mathbf{BSpin}_{\text{conn}} \times \mathbf{B}E_8 & \xrightarrow{(u, \mathbf{a})} & \mathbf{BSpin}^{\nu_4} \times \mathbf{B}^3 U(1) \end{array}, \quad (5.18)$$

where u is the canonical morphism from example 5.2.115.

Remark 5.2.124. By the pasting law, prop. 2.3.2, \mathbf{CField} is equivalently given as the homotopy pullback

$$\begin{array}{ccc} \mathbf{CField} & \xrightarrow{\hat{\mathbf{G}}_4} & \mathbf{B}^3 U(1)_{\text{conn}} \\ \downarrow & & \downarrow \\ \mathbf{BSpin}_{\text{conn}} \times \mathbf{B}E_8 & \xrightarrow{\frac{1}{2}\mathbf{p}_1 + 2\mathbf{a}} & \mathbf{B}^3 U(1) \end{array}. \quad (5.19)$$

Spelling out this definition, a C -field configuration

$$(\nabla_{\mathfrak{so}}, \nabla_{b^2 \mathbb{R}}, P_{E_8}) : X \rightarrow \mathbf{CField}$$

on a smooth manifold X is the datum of

1. a principal Spin-bundle with \mathfrak{so} -connection $(P_{\text{Spin}}, \nabla_{\mathfrak{so}})$ on X ;
2. a principal E_8 -bundle P_{E_8} on X ;
3. a $U(1)$ -2-gerbe with connection $(P_{\mathbf{B}^2 U(1)}, \nabla_{\mathbf{B}^2 U(1)})$ on X ;
4. a choice of equivalence of $U(1)$ -2-gerbes between $P_{\mathbf{B}^2 U(1)}$ and the image of $P_{\text{Spin}} \times_X P_{E_8}$ via $\frac{1}{2}\mathbf{p}_1 + 2\mathbf{a}$.

It is useful to observe that there is the following further equivalent reformulation of this definition.

Proposition 5.2.125. The moduli 3-stack \mathbf{CField} from def. 5.2.123 is equivalently the homotopy pullback

$$\begin{array}{ccc} \mathbf{CField} & \longrightarrow & \Omega_{\text{cl}}^4 \\ \downarrow & & \downarrow \\ \mathbf{BSpin}_{\text{conn}} \times \mathbf{B}E_8 & \xrightarrow{(\frac{1}{2}\mathbf{p}_1 + 2\mathbf{a})_{\text{dR}}} & b_{\text{dR}} \mathbf{B}^4 \mathbb{R} \end{array}, \quad (5.20)$$

where the bottom morphism of higher stacks is presented by the correspondence of simplicial presheaves

$$\begin{array}{ccccc} \mathbf{BSpin}_{\text{conn}} \times (\mathbf{B}E_8)_{\text{diff}} & \longrightarrow & \mathbf{BSpin}_{\text{diff}} \times (\mathbf{B}E_8)_{\text{diff}} & \xrightarrow{(\frac{1}{2}\mathbf{p}_1 + 2\mathbf{a})_{\text{diff}}} & \mathbf{B}^3 U(1)_{\text{diff}} \xrightarrow{\text{curv}} b_{\text{dR}} \mathbf{B}^4 \mathbb{R} \\ \downarrow \wr & & \downarrow \wr & & \downarrow \wr \\ \mathbf{BSpin}_{\text{conn}} \times \mathbf{B}E_8 & \longrightarrow & \mathbf{BSpin} \times \mathbf{B}E_8 & \xrightarrow{\frac{1}{2}\mathbf{p}_1 + 2\mathbf{a}} & \mathbf{B}^3 U(1) \end{array}. \quad (5.21)$$

Moreover, it is equivalently the homotopy pullback

$$\begin{array}{ccc} \mathbf{CField} & \longrightarrow & \Omega_{\text{cl}}^4 \\ \downarrow & & \downarrow \\ \mathbf{BSpin}_{\text{conn}} \times \mathbf{B}E_8 & \xrightarrow{(\frac{1}{4}\mathbf{p}_1 + \mathbf{a})_{\text{dR}}} & b_{\text{dR}} \mathbf{B}^4 \mathbb{R} \end{array}, \quad (5.22)$$

where now the bottom morphism is the composite of the bottom morphism before, postcomposed with the morphism

$$\frac{1}{2} : \flat_{\text{dR}} \mathbf{B}^4 \mathbb{R} \rightarrow \flat_{\text{dR}} \mathbf{B}^4 \mathbb{R}$$

that is given, via Dold-Kan, by division of differential forms by 2.

Proof. By the pasting law for homotopy pullbacks, prop. 2.3.2, the first homotopy pullback above may be computed as two consecutive homotopy pullbacks

$$\begin{array}{ccccc} \mathbf{CField} & \longrightarrow & \mathbf{B}^n U(1)_{\text{conn}} & \longrightarrow & \Omega_{\text{cl}}^4 \\ \downarrow & & \downarrow & & \downarrow \\ \mathbf{BSpin}_{\text{conn}} \times \mathbf{BE}_8 & \xrightarrow{\frac{1}{2}p_1 + 2a} & \mathbf{B}^3 U(1) & \xrightarrow{\text{curv}} & \flat_{\text{dR}} \mathbf{B}^4 \mathbb{R} \end{array},$$

which exhibits on the right the defining pullback of def. 4.4.91, and thus on the left the one from def. 5.2.123. The statement about the second homotopy pullback above follows analogously after noticing that

$$\begin{array}{ccc} \Omega_{\text{cl}}^4 & \xrightarrow{1/2} & \Omega_{\text{cl}}^4 \\ \downarrow & & \downarrow \\ \flat_{\text{dR}} \mathbf{B}^4 \mathbb{R} & \xrightarrow{1/2} & \flat_{\text{dR}} \mathbf{B}^4 \mathbb{R} \end{array}. \quad (5.23)$$

is a homotopy pullback. □

It is therefore useful to introduce labels as follows.

Definition 5.2.126. We label the structure morphism of the above composite homotopy pullback as

$$\begin{array}{ccccc} \mathbf{CField} & \xrightarrow{\hat{G}_4} & \mathbf{B}^3 U(1)_{\text{conn}} & \xrightarrow{\mathcal{G}_4} & \Omega_{\text{cl}}^4 \\ \downarrow & \swarrow \simeq & \downarrow G_4 & \swarrow \simeq & \downarrow \\ \mathbf{BSpin}_{\text{conn}} \times \mathbf{BE}_8 & \xrightarrow{\frac{1}{2}p_1 + 2a} & \mathbf{B}^3 U(1) & \xrightarrow{\text{curv}} & \flat_{\text{dR}} \mathbf{B}^4 U(1) \end{array}.$$

Here \hat{G}_4 sends a C-field configuration to an underlying circle 3-bundle with connection, whose curvature 4-form is \mathcal{G}_4 .

Remark 5.2.127. These equivalent reformulations show two things.

1. The C-field model may be thought of as containing *E_8 -pseudo-connections*. That is, there is a higher gauge in which a field configuration consists of an E_8 -connection on an E_8 -bundle – even though there is no dynamical E_8 -gauge field in 11d supergravity – but where gauge transformations are allowed to freely shift these connections.
2. There is a precise sense in which imposing the quantization condition (5.17) on integral cohomology is equivalent to imposing the condition $[G_4]/2 = \frac{1}{4}p_1 + a$ in de Rham cohomology / real singular cohomology.

Observation 5.2.128. When restricted to a fixed Spin-connection, gauge equivalence classes of configurations classified by \mathbf{CField} naturally form a torsor over the ordinary degree-4 differential cohomology $H_{\text{diff}}^4(X)$.

Proof. By the general discussion of differential integral Wu-structures in section 5.2.9.2. □

5.2.9.5 The homotopy type of the moduli stack We discuss now the homotopy type of the 3-groupoid

$$\mathbf{CField}(X) := \mathbf{H}(X, \mathbf{CField})$$

of C-field configurations over a given spacetime manifold X . In terms of gauge theory, its 0-th homotopy group is the set of *gauge equivalence classes* of field configurations, its first homotopy group is the set of *gauge-of-gauge equivalence classes* of auto-gauge transformations of a given configuration, and so on.

Definition 5.2.129. For X a smooth manifold, let

$$\begin{array}{ccc} & & \mathbf{BSpin}_{\text{conn}} \\ & \nearrow \nabla_{s\circ} & \downarrow \\ X & \xrightarrow{P_{\text{Spin}}} & \mathbf{BSpin} \end{array}$$

be a fixed spin structure with fixed spin connection. The restriction of $\mathbf{CField}(X)$ to this fixed spin connection is the homotopy pullback

$$\begin{array}{ccc} \mathbf{CField}(X)_{P_{\text{Spin}}} & \xrightarrow{\quad} & \mathbf{CField}(X) \\ \downarrow & & \downarrow \\ \mathbf{H}(X, \mathbf{B}E_8) & \xrightarrow{((P_{\text{Spin}}, \nabla_{s\circ}), \text{id})} & \mathbf{H}(X, \mathbf{BSpin}_{\text{conn}} \times \mathbf{B}E_8) \end{array}$$

Proposition 5.2.130. *The gauge equivalence classes of $\mathbf{CField}(X)_{P_{\text{Spin}}}$ naturally surjects onto the differential integral Wu structures on X , relative to $\frac{1}{2}p_1(P_{\text{Spin}}) \bmod 2$, (example 5.2.115):*

$$\pi_0 \mathbf{CField}(X)_{P_{\text{Spin}}} \longrightarrow \hat{H}^{\frac{n+1}{2}p_1(P_{\text{Spin}})}(X) .$$

The gauge-of-gauge equivalence classes of the auto-gauge transformation of the trivial C-field configuration naturally surject onto $H^2(X, U(1))$:

$$\pi_1 \mathbf{CField}(X)_{P_{\text{Spin}}} \twoheadrightarrow H^2(X, U(1)) .$$

Proof. By def. 5.2.123 and the pasting law, prop. 2.3.2, we have a pasting diagram of homotopy pullbacks of the form

$$\begin{array}{ccccc} \mathbf{CField}(X)_{P_{\text{Spin}}} & \twoheadrightarrow & \mathbf{H}_{\frac{1}{2}p_1(P_{\text{Spin}})}(X, \mathbf{B}^n U(1)_{\text{conn}}^{\nu_4}) & \xrightarrow{\quad} & \mathbf{H}(X, \mathbf{B}^n U(1)_{\text{conn}}^{\nu_4}) \\ \downarrow & & \downarrow & & \downarrow \\ \mathbf{H}(X, \mathbf{B}E_8) & \xrightarrow{\mathbf{H}(X, \mathbf{a})} & \mathbf{H}(X, \mathbf{B}^3 U(1)) & \xrightarrow{(\nabla_{s\circ}, \text{id})} & \mathbf{H}(X, \mathbf{BSpin}_{\text{conn}} \times \mathbf{B}^3 U(1)) \xrightarrow{(u, \text{id})} \mathbf{H}(X, \mathbf{BSpin}^{\nu_4} \times \mathbf{B}^3 U(1)) \end{array}$$

where in the middle of the top row we identified, by def. 5.2.119, the n -groupoid of smooth differential Wu structures lifting the smooth Wu structure $\frac{1}{2}p_1(P_{\text{Spin}})$.

Due to prop. 5.2.120 we are therefore reduced to showing that the top left morphism is surjective on π_0 .

But the bottom left morphism is surjective on π_0 , by prop. 5.2.122. Now, the morphisms surjective on π_0 are precisely the *effective epimorphisms* in ∞Grpd , and these are stable under pullback. Hence the first claim follows.

For the second, we use that

$$\pi_1 \mathbf{CField}(X)_{P_{\text{Spin}}} \simeq \pi_0 \Omega \mathbf{CField}(X)_{P_{\text{Spin}}}$$

and that forming loop space objects (being itself a homotopy pullback) commutes with homotopy pullbacks and with taking cocycles with coefficients in higher stacks, $\mathbf{H}(X, -)$.

Therefore the image of the left square in the above under Ω is the homotopy pullback

$$\begin{array}{ccc} \Omega \mathbf{CField}(X)_{P_{\text{Spin}}} & \longrightarrow & \mathbf{H}_{\frac{1}{2} \mathbf{P}_1(P_{\text{Spin}})}(X, \mathbf{B}^n U(1)_{\text{conn}}^{\nu_4}) \\ \downarrow & & \downarrow \\ C^\infty(X, E_8) & \xrightarrow{\mathbf{H}(X, \Omega \mathbf{a})} & \mathbf{H}(X, \mathbf{B}^2 U(1)) \end{array},$$

where in the bottom left corner we used

$$\begin{aligned} \Omega \mathbf{H}(X, \mathbf{B} E_8) &\simeq \mathbf{H}(X, \Omega \mathbf{B} E_8) \\ &\simeq \mathbf{H}(X, E_8) \quad , \\ &\simeq C^\infty(X, E_8) \end{aligned}$$

and similarly for the bottom right corner. This identifies the bottom morphism on connected components as the morphism that sends a smooth function $X \rightarrow E_8$ to its homotopy class under the homotopy equivalence $E_8 \simeq_{15} B^2 U(1) \simeq K(\mathbb{Z}, 3)$, which holds over the 11-dimensional X .

Therefore the bottom morphism is again surjective on π_0 , and so is the top morphism. The claim then follows with prop. 5.2.116. \square

5.2.9.6 Boundary moduli of the C-field We consider now ∂X (a neighbourhood of) the boundary of spacetime X , and discuss a variant of the moduli stack \mathbf{CField} that encodes the boundary configurations of the supergravity C field.

Two different kinds of boundary conditions for the C -field appear in the literature.

- On an M5-brane boundary, the integral class underlying the C -field vanishes. (For instance page 24 of [Wi96]).
- On the fixed points of a 3-bundle-*orientifold*, def. 5.2.5, for the case that X has an $S^1//\mathbb{Z}_2$ -orbifold factor, the C -field vanishes entirely. (This is considered in [HoWi95]. See section 3.1 of [Fal] for details.)

We construct higher moduli stacks for both of these conditions in the following. In addition to being restricted, the supergravity fields on a boundary also pick up additional degrees of freedom

- The E_8 -principal bundle over the boundary is equipped with a connection.

We present now a sequence of natural morphisms of 3-stacks

$$\begin{array}{ccccc} \mathbf{CField}^{\text{bdr}'} & \longrightarrow & \mathbf{CField}^{\text{bdr}} & \xrightarrow{\iota} & \mathbf{CField} \\ & & \searrow & \nearrow & \\ & & & \iota' & \end{array}$$

into the moduli stack of bulk C -fields, such that C -field configurations on X with the above behaviour over ∂X correspond to the *relative cohomology*, def. 3.6.274, with coefficients in ι or ι' , respectively, hence to commuting diagrams of the form

$$\begin{array}{ccc} \partial X & \xrightarrow{\phi_{\text{bdr}}} & \mathbf{CField}^{\text{bdr}} \\ \downarrow & & \downarrow \iota \\ X & \xrightarrow{\phi} & \mathbf{CField} \end{array},$$

and analogously for the primed case. (This is directly analogous to the characterization of type II supergravity field configurations in the presence of D -branes as discussed in 5.2.7.2.)

To this end, recall the general diagram of moduli stacks from def. 3.9.59 that relates the characteristic map $\frac{1}{2}\mathbf{p}_1 + 2\mathbf{a}$ with its differential refinement $\frac{1}{2}\hat{\mathbf{p}}_1 + 2\hat{\mathbf{a}}$:

$$\begin{array}{ccc} \mathbf{B}(\mathrm{Spin} \times E_8) & \xrightarrow{b\frac{1}{2}\mathbf{p}_1+2b\mathbf{a}} & b\mathbf{B}^3U(1) \\ \downarrow & & \downarrow \\ \mathbf{B}(\mathrm{Spin} \times E_8)_{\mathrm{conn}} & \xrightarrow{\frac{1}{2}\hat{\mathbf{p}}_1+2\hat{\mathbf{a}}} & \mathbf{B}^3U(1)_{\mathrm{conn}} \\ \downarrow & & \downarrow \\ \mathbf{B}(\mathrm{Spin} \times E_8) & \xrightarrow{\frac{1}{2}\mathbf{p}_1+2\mathbf{a}} & \mathbf{B}^3U(1) \end{array}$$

The defining ∞ -pullback diagram for $C\mathrm{Field}$ factors the lower square of this diagram as follows

$$\begin{array}{ccc} \mathbf{B}(\mathrm{Spin} \times E_8)_{\mathrm{conn}} & \xrightarrow{\frac{1}{2}\hat{\mathbf{p}}_1+2\hat{\mathbf{a}}} & \mathbf{B}^3U(1)_{\mathrm{conn}} \\ \downarrow \text{dashed} & \searrow \hat{G}_4 & \downarrow \\ C\mathrm{Field} & \xrightarrow{\hat{G}_4} & \mathbf{B}^3U(1)_{\mathrm{conn}} \\ \downarrow & & \downarrow \\ \mathbf{B}\mathrm{Spin}_{\mathrm{conn}} \times \mathbf{B}E_8 & \xrightarrow{\frac{1}{2}\mathbf{p}_1+2\mathbf{a}} & \mathbf{B}^3U(1) \end{array}$$

Here the dashed morphism is the universal morphism induced from the commutativity of the previous diagram together with the pullback property of the 3-stack $C\mathrm{Field}$. This morphism is the natural map of moduli which induces the relative cohomology that makes the E_8 -bundle pick up a connection on the boundary.

It therefore remains to model the condition that G_4 or even \hat{G}_4 vanishes on the boundary. This condition is realized by further pulling back along the sequence

$$* \xrightarrow{0} \Omega^3(-) \longrightarrow \mathbf{B}^3U(1)_{\mathrm{conn}} .$$

Definition 5.2.131. Write $C\mathrm{Field}^{\mathrm{bdr}}$ and $C\mathrm{Field}^{\mathrm{bdr}'}$, respectively, for the moduli 3-stacks which arise as homotopy pullbacks in the top rectangles of

$$\begin{array}{ccc} C\mathrm{Field}^{\mathrm{bdr}'} & \xrightarrow{\quad} & * \\ \downarrow & & \downarrow 0 \\ C\mathrm{Field}^{\mathrm{bdr}} & \xrightarrow{\quad} & \Omega^3(-) \\ \downarrow & & \downarrow \\ \mathbf{B}(\mathrm{Spin} \times E_8)_{\mathrm{conn}} & \xrightarrow{\frac{1}{2}\hat{\mathbf{p}}_1+2\hat{\mathbf{a}}} & \mathbf{B}^3U(1)_{\mathrm{conn}} \\ \downarrow \text{dashed} & & \downarrow \parallel \\ C\mathrm{Field} & \xrightarrow{\hat{G}_4} & \mathbf{B}^3U(1)_{\mathrm{conn}} \end{array}$$

ι' (curved arrow from $C\mathrm{Field}^{\mathrm{bdr}'}$ to $C\mathrm{Field}$)
 ι (curved arrow from $C\mathrm{Field}^{\mathrm{bdr}}$ to $C\mathrm{Field}$)

For X a smooth manifold with boundary, we say that the 3-groupoid of C -field configurations with boundary data on X is the hom ∞ -groupoid

$$\mathbf{H}^I(\partial X \rightarrow X, C\mathrm{Field}^{\mathrm{bdr}} \xrightarrow{\iota} C\mathrm{Field}),$$

in the arrow category of the ambient ∞ -topos $\mathbf{H} = \mathrm{Smooth}\infty\mathrm{Grp}$, where on the right we have the composite morphism indicated by the curved arrow above, and analogously for the primed case.

Observation 5.2.132. The moduli 3-stack $C\text{Field}^{\text{brd}}$ is equivalent to is the moduli 3-stack of twisted $\text{String}^{2\mathbf{a}}$ -2-connections whose underlying twist has trivial class. The moduli 3-stack $C\text{Field}^{\text{bdr}'}$ is equivalent to the moduli 3-stack of untwisted $\text{String}^{2\mathbf{a}}$ -2-connections

$$C\text{Field}^{\text{bdr}'} \simeq \text{String}_{\text{conn}}^{2\mathbf{a}}.$$

This is presented via Lie integration of L_∞ -algebras as

$$C\text{Field}^{\text{bdr}'} \simeq \mathbf{cosk}_3 \exp((\mathfrak{so} \oplus \mathfrak{e}_8)_{\mu_3^{\mathfrak{so}} + \mu_3^{\mathfrak{e}_8}})_{\text{conn}}.$$

The presentation of $C\text{Field}^{\text{bdr}}$ by Lie integration is locally given by

$$\left(\begin{array}{l} F_A = dA + \frac{1}{2}[A \wedge A] \\ H_3 = \nabla B := dB + \text{CS}(A) - C_3 \\ \mathcal{G}_4 = dC_3 \\ dF_A = -[A \wedge F_A] \\ dH_3 = \langle F_A \wedge F_A \rangle - \mathcal{G}_4 \\ d\mathcal{G}_4 = 0 \end{array} \right)_i \quad \begin{array}{l} t^a \mapsto A^a \\ r^a \mapsto F_A^a \\ b \mapsto B \\ c \mapsto C_3 \\ h \mapsto H_3 \\ g \mapsto \mathcal{G}_4 \end{array} \quad \left(\begin{array}{l} r^a = dt^a + \frac{1}{2}C^a_{bc}t^b \wedge t^c + \\ h = db + cs - c \\ g = dc \\ dr^a = -C^a_{bc}t^b \wedge r^a \\ dh = \langle -, - \rangle - g \\ dg = 0 \end{array} \right),$$

where

$$\mathfrak{g} = \mathfrak{so} \oplus \mathfrak{e}_8$$

and hence

$$A = \omega + A_{\mathfrak{e}_8}.$$

Proof. By definition 3.9.62 and prop. 5.1.46. □

Remark 5.2.133. Notice that with respect to String-connections, there are two levels of twists here:

1. The C -field 3-form twists the $\text{String}^{2\mathbf{a}}$ -2-connections.
2. For vanishing C -field 3-form, a $\text{String}^{2\mathbf{a}}$ -2-connection is still a twisted String-2-connection, where the twist is now by the Chern-Simons 3-bundle with connection of the underlying E_8 -bundle with connection.

5.2.9.7 Hořava-Witten boundaries are membrane orientifolds We now discuss a natural formulation of the origin of the Hořava-Witten boundary conditions [HoWi95] in terms of higher stacks and nonabelian differential cohomology, specifically, in terms of what we call *membrane orientifolds*. From this we obtain a corresponding refinement of the moduli 3-stack of C-field configurations which now explicitly contains the twisted \mathbb{Z}_2 -equivariance of the Hořava-Witten background.

Recall the notion of higher orientifolds and their identification with twisted differential \mathbf{J}_n -structures from 5.2.5.

Observation 5.2.134. Let $U//\mathbb{Z}_2 \hookrightarrow Y//\mathbb{Z}_2$ be a patch on which a given $\hat{\mathbf{J}}_n$ -structure has a trivial underlying integral class, such that it is equivalent to a globally defined $(n+1)$ -form C_U on U . Then the components of this this 3-form orthogonal to the \mathbb{Z}_2 -action are *odd* under the action. In particular, if $U \hookrightarrow Y$ sits in the fixed point set of the action, then these components vanish. This is the Hořava-Witten boundary condition on the C -field on an 11-dimensional spacetime $Y = X \times S^1$ equipped with \mathbb{Z}_2 -action on the circle. See for instance section 3 of [Fal] for an explicit discussion of the \mathbb{Z}_2 action on the C-field in this context.

We therefore have a natural construction of the moduli 3-stack of Hořava-Witten C-field configurations as follows

Definition 5.2.135. Let $\mathbf{CField}_J(Y)$ be the homotopy pullback in

$$\begin{array}{ccc}
 \mathbf{CField}_J(Y) & \longrightarrow & \hat{\mathbf{J}}\mathrm{Struc}_\rho(Y//\mathbb{Z}_2) \\
 \downarrow & & \downarrow \\
 & & \mathbf{H}(Y, \mathbf{B}^3U(1)_{\mathrm{conn}}) \\
 \downarrow & & \downarrow \\
 \mathbf{H}(Y, \mathbf{B}\mathrm{Spin}_{\mathrm{conn}} \times \mathbf{B}E_8) & \xrightarrow{\mathbf{H}(Y, \frac{1}{2}\mathbf{p}_1+2\mathbf{a})} & \mathbf{H}(Y, \mathbf{B}^3U(1)) \ ,
 \end{array}$$

where the top right morphism is the map $\hat{G}_\rho \mapsto \hat{G}$ from remark 5.2.46.

The objects of $\mathbf{CField}_J(Y)$ are C-field configurations on Y that not only satisfy the flux quantization condition, but also the Hořava-Witten twisted equivariance condition (in fact the proper globalization of that condition from 3-forms to full differential cocycles). This is formalized by the following.

Observation 5.2.136. There is a canonical morphism $\mathbf{CField}_J(Y) \rightarrow \mathbf{CField}(Y)$, being the dashed morphism in

$$\begin{array}{ccc}
 \mathbf{CField}_J(Y) & \longrightarrow & \hat{\mathbf{J}}\mathrm{Struc}_\rho(Y//\mathbb{Z}_2) \\
 \vdots & & \downarrow \\
 \mathbf{CField}(Y) & \longrightarrow & \mathbf{H}(Y, \mathbf{B}^3U(1)_{\mathrm{conn}}) \\
 \downarrow & & \downarrow \\
 \mathbf{H}(Y, \mathbf{B}\mathrm{Spin}_{\mathrm{conn}} \times \mathbf{B}E_8) & \xrightarrow{\mathbf{H}(Y, \frac{1}{2}\mathbf{p}_1+2\mathbf{a})} & \mathbf{H}(Y, \mathbf{B}^3U(1)) \ ,
 \end{array}$$

which is given by the universal property of the defining homotopy pullback of \mathbf{CField} , remark 5.2.124.

A supergravity field configuration presented by a morphism $Y \rightarrow \mathbf{CField}$ into the moduli 3-stack of configurations that satisfy the flux quantization condition in addition satisfies the Hořava-Witten boundary condition if, as an element of $\mathbf{CField}(Y) := \mathbf{H}(Y, \mathbf{CField})$ it is in the image of $\mathbf{CField}_J(Y) \rightarrow \mathbf{CField}(Y)$. In fact, there may be several such pre-images. A choice of one is a choice of membrane orientifold structure.

5.2.10 Differential T-duality

In [KaVa10] (see also the review in section 7.4 of [BuSc10]) a formalization of the differential refinement of topological T-duality is given. We discuss here how this is naturally an example of the twisted differential \mathbf{c} -structures, 3.9.8.

(...)

5.3 Higher symplectic geometry

The notion of *symplectic manifold* formalizes in physics the concept of a *classical mechanical system*. The notion of *geometric quantization*, 3.9.13, of a symplectic manifold is one formalization of the general concept in physics of *quantization* of such a system to a *quantum mechanical system*.

Or rather, the notion of symplectic manifold does not quite capture the most general systems of classical mechanics. One generalization requires passage to *Poisson manifolds*. The original methods of geometric quantization become meaningless on a Poisson manifold that is not symplectic. However, a Poisson structure on a manifold X is equivalent to the structure of a Poisson Lie algebroid \mathfrak{P} over X . This is noteworthy, because the latter *is* again symplectic, as a Lie algebroid, even if the underlying Poisson manifold is not symplectic: it is a *symplectic Lie 1-algebroid*, prop. 5.3.16.

Based on related observations it was suggested, [Wei89] that a notion of *symplectic groupoid* should naturally replace that of *symplectic manifold* for the purposes of geometric quantization to yield a notion of *geometric quantization of symplectic groupoids*. Since a symplectic manifold can be regarded as a symplectic Lie 0-algebroid, prop. 5.3.16, and also as a symplectic smooth 0-groupoid this step amounts to a kind of categorification of symplectic geometry.

More or less implicitly, there has been evidence that this shift in perspective is substantial: the *deformation quantization* of a Poisson manifold famously turns out [Kon03] to be constructible in terms of correlators of the 2-dimensional TQFT called the *Poisson σ -model*, 5.5.11.4, associated with the corresponding Poisson Lie algebroid. The fact that this is 2-dimensional and not 1-dimensional, as the quantum mechanical system that it thus encodes, is a direct reflection of this categorification shift of degree.

On general abstract grounds this already suggests that it makes sense to pass via higher categorification further to symplectic Lie n -algebroids, def. 5.3.14, as well as to symplectic 2-groupoids, symplectic 3-groupoids, etc. up to symplectic ∞ -groupoids, def. 5.3.21.

Formal hints for such a generalization had been noted in [Sev01] (in particular in its concluding table). More indirect – but all the more noteworthy – hints came from quantum field theory, where it was observed that a generalization of symplectic geometry to *multisymplectic geometry* [Hél11] of degree n more naturally captures the description of n -dimensional QFT (notice that quantum mechanics may be understood as $(0+1)$ -dimensional QFT). For, observe that the symplectic form on a symplectic Lie n -algebroid is, while always “binary”, nevertheless a representative of de Rham cohomology in degree $n+2$.

There is a natural formalization of these higher symplectic structures in the context of any cohesive ∞ -topos. Moreover, by 5.3.2 symplectic forms on L_∞ -algebroids have a natural interpretation in ∞ -Lie theory: they are L_∞ -invariant polynomials. This means that the ∞ -Chern-Weil homomorphism applies to them.

Observation 5.3.1. From the perspective of ∞ -Lie theory, a smooth manifold Σ equipped with a symplectic form ω is equivalently a Lie 0-algebroid equipped with a quadratic and non-degenerate L_∞ -invariant polynomial (def. 4.4.115).

This observation implies

1. a direct ∞ -Lie theoretic analog of symplectic manifolds: *symplectic Lie n -algebroids* and their Lie integration to *symplectic smooth ∞ -groupoids*
2. the existence of a canonical ∞ -Chern-Weil homomorphism for every symplectic Lie n -algebroid.

This is spelled out below in 5.3.1, 5.3.2, 5.3.3. The ∞ -group extensions, def. 3.6.242, that are induced by the unrefined ∞ -Chern-Weil homomorphism, 3.9.7, on a symplectic ∞ -groupoid are their *prequantum circle $(n+1)$ -bundles*, the higher analogs of prequantum line bundles in the geometric quantization of symplectic manifolds. This we discuss in 4.4.20. Further below in 5.5.11 we show that the *refined* ∞ -Chern-Weil homomorphism, 3.9.11, on a symplectic ∞ -groupoid constitutes the action functional of the corresponding *AKSZ σ -model* (discussed below in 5.5.11).

- 5.3.1 – Symplectic dg-geometry;

- 5.3.2 – Symplectic L_∞ -algebroids;
- 5.3.3 – Symplectic smooth ∞ -groupoids;

The parts 5.3.1 and 5.3.2 are taken from [FRS11].

5.3.1 Symplectic dg-geometry

In 4.5 we considered a general abstract notion of infinitesimal thickenings in higher differential geometry and showed how from the point of view of ∞ -Lie theory this leads to the notion of L_∞ -algebroids, def. 4.5.12. As is evident from that definition, these can also be regarded as objects in *dg-geometry* [ToVe05]. We make explicit now some basic aspects of this identification.

The following definitions formulate a simple notion of *affine smooth graded manifolds* and *affine smooth dg-manifolds*. Despite their simplicity these definitions capture in a precise sense all the relevant structure: namely the *local* smooth structure. Globalizations of these definitions can be obtained, if desired, by general abstract constructions.

Definition 5.3.2. The category of *affine smooth \mathbb{N} -graded manifolds* – here called *smooth graded manifolds* for short – is the full subcategory

$$\text{SmoothGrMfd} \subset \text{GrAlg}_{\mathbb{R}}^{\text{op}}$$

of the opposite category of \mathbb{N} -graded-commutative \mathbb{R} -algebras on those isomorphic to Grassmann algebras of the form

$$\wedge_{C^\infty(X_0)}^\bullet \Gamma(V^*),$$

where X_0 is an ordinary smooth manifold, $V \rightarrow X_0$ is an \mathbb{N} -graded smooth vector bundle over X_0 degreewise of finite rank, and $\Gamma(V^*)$ is the graded $C^\infty(X)$ -module of smooth sections of the dual bundle.

For a smooth graded manifold $X \in \text{SmoothGrMfd}$, we write $C^\infty(X) \in \text{cdgAlg}_{\mathbb{R}}$ for its corresponding dg-algebra of *functions*.

Remarks.

- The full subcategory of these objects is equivalent to that of all objects isomorphic to one of this form. We may therefore use both points of view interchangeably.
- Much of the theory works just as well when V is allowed to be \mathbb{Z} -graded. This is the case that genuinely corresponds to *derived* (instead of just higher) differential geometry. An important class of examples for this case are BV-BRST complexes which motivate much of the literature. For the purpose of this short note, we shall be content with the \mathbb{N} -graded case.
- For an \mathbb{N} -graded $C^\infty(X_0)$ -module $\Gamma(V^*)$ we have

$$\wedge_{C^\infty}^\bullet \Gamma(V^*) = C^\infty(X_0) \oplus \Gamma(V_0^*) \oplus (\Gamma(V_0^*) \wedge_{C^\infty(X_0)} \Gamma(V_0^*) \oplus \Gamma(V_1^*)) \oplus \cdots,$$

with the leftmost summand in degree 0, the next one in degree 1, and so on.

- There is a canonical functor

$$\text{SmoothMfd} \hookrightarrow \text{SmthGrMfd}$$

which identifies an ordinary smooth manifold X with the smooth graded manifold whose function algebra is the ordinary algebra of smooth functions $C^\infty(X_0) := C^\infty(X)$ regarded as a graded algebra concentrated in degree 0. This functor is full and faithful and hence exhibits a full subcategory.

All the standard notions of differential geometry apply to differential graded geometry. For instance for $X \in \text{SmoothGrMfd}$, there is the graded vector space $\Gamma(TX)$ of vector fields on X , where a vector field is identified with a graded *derivation* $v : C^\infty(X) \rightarrow C^\infty(X)$. This is naturally a graded (super) Lie algebra with super Lie bracket the graded commutator of derivations. Notice that for $v \in \Gamma(TX)$ of odd degree we have $[v, v] = v \circ v + v \circ v = 2v^2 : C^\infty(X) \rightarrow C^\infty(X)$.

Definition 5.3.3. The category of (affine, \mathbb{N} -graded) *smooth differential-graded manifolds* is the full subcategory

$$\text{SmoothDgMfd} \subset \text{cdgAlg}_{\mathbb{R}}^{\text{op}}$$

of the opposite of differential graded-commutative \mathbb{R} -algebras on those objects whose underlying graded algebra comes from SmoothGrMfd .

This is equivalently the category whose objects are pairs (X, v) consisting of a smooth graded manifold $X \in \text{SmoothGrMfd}$ and a grade 1 vector field $v \in \Gamma(TX)$, such that $[v, v] = 0$, and whose morphisms $(X_1, v_1) \rightarrow (X_2, v_2)$ are morphisms $f : X_1 \rightarrow X_2$ such that $v_1 \circ f^* = f^* \circ v_2$.

Remark 5.3.4. The dg-algebras appearing here are special in that their degree-0 algebra is naturally not just an \mathbb{R} -algebra, but a *smooth algebra* (a “ C^∞ -ring”, see [Stel10] for review and discussion).

Definition 5.3.5. The *de Rham complex functor*

$$\Omega^\bullet(-) : \text{SmoothGrMfd} \rightarrow \text{cdgAlg}_{\mathbb{R}}^{\text{op}}$$

sends a dg-manifold X with $C^\infty(X) \simeq \wedge_{C^\infty(X_0)}^\bullet \Gamma(V^*)$ to the Grassmann algebra over $C^\infty(X_0)$ on the graded $C^\infty(X_0)$ -module

$$\Gamma(T^*X) \oplus \Gamma(V^*) \oplus \Gamma(V^*[-1]),$$

where $\Gamma(T^*X)$ denotes the ordinary smooth 1-form fields on X_0 and where $V^*[-1]$ is V^* with the grades *increased* by one. This is equipped with the differential \mathbf{d} defined on generators as follows:

- $\mathbf{d}|_{C^\infty(X_0)} = d_{\text{dR}}$ is the ordinary de Rham differential with values in $\Gamma(T^*X)$;
- $\mathbf{d}|_{\Gamma(V^*)} \rightarrow \Gamma(V^*[-1])$ is the degree-shift isomorphism
- and \mathbf{d} vanishes on all remaining generators.

Definition 5.3.6. Observe that $\Omega^\bullet(-)$ evidently factors through the defining inclusion $\text{SmoothDgMfd} \hookrightarrow \text{cdgAlg}_{\mathbb{R}}$. Write

$$\mathfrak{T}(-) : \text{SmoothGrMfd} \rightarrow \text{SmoothDgMfd}$$

for this factorization.

The dg-space $\mathfrak{T}X$ is often called the *shifted tangent bundle* of X and denoted $T[1]X$.

Observation 5.3.7. For Σ an ordinary smooth manifold and for X a graded manifold corresponding to a vector bundle $V \rightarrow X_0$, there is a natural bijection

$$\text{SmoothGrMfd}(\mathfrak{T}\Sigma, X) \simeq \Omega^\bullet(\Sigma, V)$$

where on the right we have the set of V -valued smooth differential forms on Σ : tuples consisting of a smooth function $\phi_0 : \Sigma \rightarrow X_0$, and for each $n > 1$ an ordinary differential n -form $\phi_n \in \Omega^n(\Sigma, \phi_0^* V_{n-1})$ with values in the pullback bundle of V_{n-1} along ϕ_0 .

The standard Cartan calculus of differential geometry generalizes directly to graded smooth manifolds. For instance, given a vector field $v \in \Gamma(TX)$ on $X \in \text{SmoothGrMfd}$, there is the *contraction derivation*

$$\iota_v : \Omega^\bullet(X) \rightarrow \Omega^\bullet(X)$$

on the de Rham complex of X , and hence the *Lie derivative*

$$\mathcal{L}_v := [\iota_v, \mathbf{d}] : \Omega^\bullet(X) \rightarrow \Omega^\bullet(X).$$

Definition 5.3.8. For $X \in \text{SmoothGrMfd}$ the *Euler vector field* $\epsilon \in \Gamma(TX)$ is defined over any coordinate patch $U \rightarrow X$ to be given by the formula

$$\epsilon|_U := \sum_a \deg(x^a) x^a \frac{\partial}{\partial x^a},$$

where $\{x^a\}$ is a basis of generators and $\deg(x^a)$ the degree of a generator. The *grade* of a homogeneous element α in $\Omega^\bullet(X)$ is the unique natural number $n \in \mathbb{N}$ with

$$\mathcal{L}_\epsilon \alpha = n\alpha.$$

Remarks.

- This implies that for x^i an element of grade n on U , the 1-form $\mathbf{d}x^i$ is also of grade n . This is why we speak of *grade* (as in “graded manifold”) instead of *degree* here.
- Since coordinate transformations on a graded manifold are grading-preserving, the Euler vector field is indeed well-defined. Note that the degree-0 coordinates do not appear in the Euler vector field.

The existence of ϵ implies the following useful statement (amplified in [Roy02]), which is a trivial variant of what in grade 0 would be the standard Poincaré lemma.

Observation 5.3.9. On a graded manifold, every closed differential form ω of positive grade n is exact: the form

$$\lambda := \frac{1}{n} \iota_\epsilon \omega$$

satisfies

$$\mathbf{d}\lambda = \omega.$$

Definition 5.3.10. A *symplectic dg-manifold* of grade $n \in \mathbb{N}$ is a dg-manifold (X, v) equipped with 2-form $\omega \in \Omega^2(X)$ which is

- non-degenerate;
- closed;

as usual for symplectic forms, and in addition

- of grade n ;
- v -invariant: $\mathcal{L}_v \omega = 0$.

In a local chart U with coordinates $\{x^a\}$ we may find functions $\{\omega_{ab} \in C^\infty(U)\}$ such that

$$\omega|_U = \frac{1}{2} \mathbf{d}x^a \omega_{ab} \wedge \mathbf{d}x^b,$$

where summation of repeated indices is implied. We say that U is a *Darboux chart* for (X, ω) if the ω_{ab} are constant.

Observation 5.3.11. The function algebra of a symplectic dg-manifold (X, ω) of grade n is naturally equipped with a Poisson bracket

$$\{-, -\} : C^\infty(X) \otimes C^\infty(X) \rightarrow C^\infty(X)$$

which decreases grade by n . On a local coordinate patch $\{x^a\}$ this is given by

$$\{f, g\} = \frac{f \mathfrak{G}}{x^a \mathfrak{G}} \omega^{ab} \frac{\partial g}{\partial x^b},$$

where $\{\omega^{ab}\}$ is the inverse matrix to $\{\omega_{ab}\}$, and where the graded differentiation in the left factor is to be taken from the right, as indicated.

Definition 5.3.12. For $\pi \in C^\infty(X)$ and $v \in \Gamma(TX)$, we say that π is a *Hamiltonian for v* , or equivalently, that v is the of π if

$$\mathbf{d}\pi = \iota_v \omega.$$

Note that the convention $(-1)^{n+1} \mathbf{d}\pi = \iota_v \omega$ is also frequently used for defining Hamiltonians in the context of graded geometry.

Remark 5.3.13. In a local coordinate chart $\{x^a\}$ the defining equation $\mathbf{d}\pi = \iota_v \omega$ becomes

$$\mathbf{d}x^a \frac{\partial \pi}{\partial x^a} = \omega_{ab} v^a \wedge \mathbf{d}x^b = \omega_{ab} \mathbf{d}x^a \wedge v^b,$$

implying that

$$\omega_{ab} v^b = \frac{\partial \pi}{\partial x^a}.$$

5.3.2 Symplectic L_∞ -algebroids

Here we discuss L_∞ -algebroids, def. 4.5.12, equipped with *symplectic structure*, which we conceive of as: equipped with de Rham cocycles that are *invariant polynomials*, def. 4.4.115.

Definition 5.3.14. A *symplectic Lie n -algebroid* (\mathfrak{P}, ω) is a Lie n -algebroid \mathfrak{P} equipped with a quadratic non-degenerate invariant polynomial $\omega \in W(\mathfrak{P})$ of degree $n + 2$.

This means that

- on each chart $U \rightarrow X$ of the base manifold X of \mathfrak{P} , there is a basis $\{x^a\}$ for $\text{CE}(\mathfrak{a}|_U)$ such that

$$\omega = \frac{1}{2} \mathbf{d}x^a \omega_{ab} \wedge \mathbf{d}x^b$$

with $\{\omega_{ab} \in \mathbb{R} \hookrightarrow C^\infty(X)\}$ and $\deg(x^a) + \deg(x^b) = n$;

- the coefficient matrix $\{\omega_{ab}\}$ has an inverse;
- we have

$$d_{\mathbf{W}(\mathfrak{P})} \omega = d_{\text{CE}(\mathfrak{P})} \omega + \mathbf{d}\omega = 0.$$

The following observation essentially goes back to [Sev01] and [Roy02].

Proposition 5.3.15. *There is a full and faithful embedding of symplectic dg-manifolds of grade n into symplectic Lie n -algebroids.*

Proof. The dg-manifold itself is identified with an L_∞ -algebroid by def. 4.5.12. For $\omega \in \Omega^2(X)$ a symplectic form, the conditions $\mathbf{d}\omega = 0$ and $\mathcal{L}_v \omega = 0$ imply $(\mathbf{d} + \mathcal{L}v)\omega = 0$ and hence that under the identification $\Omega^\bullet(X) \simeq \mathbf{W}(\mathfrak{a})$ this is an invariant polynomial on \mathfrak{a} .

It remains to observe that the L_∞ -algebroid \mathfrak{a} is in fact a Lie n -algebroid. This is implied by the fact that ω is of grade n and non-degenerate: the former condition implies that it has no components in elements of grade $> n$ and the latter then implies that all such elements vanish. \square

The following characterization may be taken as a definition of Poisson Lie algebroids and Courant Lie 2-algebroids.

Proposition 5.3.16. *Symplectic Lie n -algebroids are equivalently:*

- for $n = 0$: ordinary symplectic manifolds;
- for $n = 1$: Poisson Lie algebroids;

- for $n = 2$: Courant Lie 2-algebroids.

See [Roy02, Sev01] for more discussion.

Proposition 5.3.17. *Let (\mathfrak{P}, ω) be a symplectic Lie n -algebroid for positive n in the image of the embedding of proposition 5.3.15. Then it carries the canonical L_∞ -algebroid cocycle*

$$\pi := \frac{1}{n+1} \iota_\epsilon \iota_v \omega \in \text{CE}(\mathfrak{P})$$

which moreover is the Hamiltonian, according to definition 5.3.12, of $d_{\text{CE}(\mathfrak{P})}$.

Proof. Since $\mathbf{d}\omega = \mathcal{L}_v \omega = 0$, we have

$$\begin{aligned} \mathbf{d} \iota_\epsilon \iota_v \omega &= \mathbf{d} \iota_v \iota_\epsilon \omega \\ &= (\iota_v \mathbf{d} - \mathcal{L}_v) \iota_\epsilon \omega \\ &= \iota_v \mathcal{L}_\epsilon \omega - [\mathcal{L}_v, \iota_\epsilon] \omega \\ &= n \iota_v \omega - \iota_{[v, \epsilon]} \omega \\ &= (n+1) \iota_v \omega, \end{aligned}$$

where Cartan's formula $[\mathcal{L}_v, \iota_\epsilon] = \iota_{[v, \epsilon]}$ and the identity $[v, \epsilon] = -[\epsilon, v] = -v$ have been used. Therefore $\pi := \frac{1}{n+1} \iota_\epsilon \iota_v \omega$ satisfies the defining equation $\mathbf{d}\pi = \iota_v \omega$ from definition 5.3.12. \square

Remark 5.3.18. On a local chart with coordinates $\{x^a\}$ we have

$$\pi|_U = \frac{1}{n+1} \omega_{ab} \deg(x^a) x^a \wedge v^b.$$

Our central observation now is the following.

Proposition 5.3.19. *The cocycle $\frac{1}{n}\pi$ from prop. 5.3.17 is in transgression with the invariant polynomial ω . A Chern-Simons element witnessing the transgression according to def. 4.4.119 is*

$$\text{cs} = \frac{1}{n} (\iota_\epsilon \omega + \pi).$$

Proof. It is clear that $i^* \text{cs} = \frac{1}{n} \pi$. So it remains to check that $d_{\text{W}(\mathfrak{P})} \text{cs} = \omega$. As in the proof of proposition 5.3.17, we use $\mathbf{d}\omega = \mathcal{L}_v \omega = 0$ and Cartan's identity $[\mathcal{L}_v, \iota_\epsilon] = \iota_{[v, \epsilon]} = -\iota_v$. By these, the first summand in $d_{\text{W}(\mathfrak{P})}(\iota_\epsilon \omega + \pi)$ is

$$\begin{aligned} d_{\text{W}(\mathfrak{P})} \iota_\epsilon \omega &= (\mathbf{d} + \mathcal{L}_v) \iota_\epsilon \omega \\ &= [\mathbf{d} + \mathcal{L}_v, \iota_\epsilon] \omega \\ &= n\omega - \iota_v \omega \\ &= n\omega - \mathbf{d}\pi \end{aligned}$$

The second summand is simply

$$d_{\text{W}(\mathfrak{P})} \pi = \mathbf{d}\pi$$

since π is a cocycle. \square

Remark 5.3.20. In a coordinate patch $\{x^a\}$ the Chern-Simons element is

$$\text{cs}|_U = \frac{1}{n} (\omega_{ab} \deg(x^a) x^a \wedge \mathbf{d}x^b + \pi).$$

In this formula one can substitute $\mathbf{d} = d_W - d_{\text{CE}}$, and this kind of substitution will be crucial for the proof of our main statement in proposition 5.5.52 below. Since $d_{\text{CE}}x^i = v^i$ and using remark 5.3.18 we find

$$\sum_a \omega_{ab} \deg(x^a) x^a \wedge d_{\text{CE}} x^b = (n+1)\pi,$$

and hence

$$\text{cs}|_U = \frac{1}{n} (\deg(x^a) \omega_{ab} x^a \wedge d_{W(\mathfrak{P})} x^b - n\pi).$$

In the section 5.5.11 we show that this transgression element cs is the AKSZ-Lagrangian.

5.3.3 Symplectic smooth ∞ -groupoids

We define *symplectic smooth ∞ -groupoids* in terms of their underlying symplectic L_∞ -algebroids.

Recall that for any $n \in \mathbb{N}$, a *symplectic Lie n -algebroid* (\mathfrak{P}, ω) is (def. 5.3.14) an L_∞ -algebroid \mathfrak{P} that is equipped with a quadratic and non-degenerate L_∞ -invariant polynomial. Under Lie integration, def. 4.4.56, \mathfrak{P} integrates to a smooth n -groupoid $\tau_n \exp(\mathfrak{P}) \in \text{Smooth}\infty\text{Grpd}$. Under the ∞ -Chern-Weil homomorphism, 4.4.17, the invariant polynomial induces a differential form on the smooth ∞ -groupoid, 3.9.3:

$$\omega : \tau_n \exp(\mathfrak{P}) \rightarrow \mathfrak{b}_{\text{dR}} \mathbf{B}^{n+2}\mathbb{R}$$

representing a class $[\omega] \in H_{\text{dR}}^{n+2}(\tau_n \exp(\mathfrak{P}))$.

Definition 5.3.21. Write

$$\text{SymplSmooth}\infty\text{Grpd} \hookrightarrow \text{Smooth}\infty\text{Grpd} / \left(\prod_n \mathfrak{b}_{\text{dR}} \mathbf{B}^{n+2}\mathbb{R} \right)$$

for the full sub- ∞ -category of the over- ∞ -topos of $\text{Smooth}\infty\text{Grpd}$ over the de Rham coefficient objects on those objects in the image of this construction.

We say an object on $\text{SymplSmooth}\infty\text{Grpd}$ is a *symplectic smooth ∞ -groupoid*.

Remark 5.3.22. There are evident variations of this for the ambient $\text{Smooth}\infty\text{Grpd}$ replaced by some variant, such as $\text{SynthDiffInfGrpd}\infty\text{Grpd}$, or $\text{SmoothSuper}\infty\text{Grpd}$, 4.6).

We now spell this out for $n = 1$. The following notion was introduced in [Wei89] in the study of geometric quantization.

Definition 5.3.23. A *symplectic groupoid* is a Lie groupoid \mathcal{G} equipped with a differential 2-form $\omega_1 \in \Omega^2(\mathcal{G}_1)$ which is

1. a symplectic 2-form on \mathcal{G}_1 ;
2. closed as a simplicial form:

$$\delta\omega_1 = \partial_0^* \omega_1 - \partial_1^* \omega_1 + \partial_2^* \omega_1 = 0,$$

where $\partial_i : \mathcal{G}_2 \rightarrow \mathcal{G}_1$ are the face maps in the nerve of \mathcal{G} .

Example 5.3.24. Let (X, ω) be an ordinary symplectic manifold. Then its fundamental groupoid $\Pi_1(X)$ canonically is a symplectic groupoid with $\omega_1 := \partial_1^* \omega - \partial_0^* \omega$.

Proposition 5.3.25. Let \mathfrak{P} be the *symplectic Lie 1-algebroid (Poisson Lie algebroid)*, def. 5.3.14, induced by the *Poisson manifold structure* corresponding to (X, ω) . Write

$$\omega : \mathfrak{T}\mathfrak{P} \rightarrow \mathfrak{T}\mathfrak{b}^3\mathbb{R}$$

for the canonical invariant polynomial.

Then the corresponding ∞ -Chern-Weil homomorphism according to 4.4.17

$$\exp(\omega) : \exp(\mathfrak{P})_{\text{diff}} \rightarrow \mathfrak{B}_{\text{dR}}^3\mathbb{R}$$

exhibits the symplectic groupoid from example 5.3.24.

Proof. We start with the simple situation where (X, ω) has a global Darboux coordinate chart $\{x^i\}$. Write $\{\omega_{ij}\}$ for the components of the symplectic form in these coordinates, and $\{\omega^{ij}\}$ for the components of the inverse.

Then the Chevalley-Eilenberg algebra $\text{CE}(\mathfrak{P})$ is generated from $\{x^i\}$ in degree 0 and $\{\partial_i\}$ in degree 1, with differential given by

$$\begin{aligned} d_{\text{CE}}x^i &= -\omega^{ij}\partial_j \\ d_{\text{CE}}\partial_i &= \frac{\partial\pi^{jk}}{\partial x^i}\partial_j \wedge \partial_k = 0. \end{aligned}$$

The differential in the corresponding Weil algebra is hence

$$\begin{aligned} d_{\text{W}}x^i &= -\omega^{ij}\partial_j + \mathbf{d}x^i \\ d_{\text{W}}\partial_i &= \mathbf{d}\partial_i. \end{aligned}$$

By prop. 5.3.16, the symplectic invariant polynomial is

$$\omega = \mathbf{d}x^i \wedge \mathbf{d}\partial_i \in W(\mathfrak{P}).$$

Clearly it is useful to introduce a new basis of generators with

$$\partial^i := -\omega^{ij}\partial_j.$$

In this new basis we have a manifest isomorphism

$$\text{CE}(\mathfrak{P}) = \text{CE}(\mathfrak{T}X)$$

with the Chevalley-Eilenberg algebra of the tangent Lie algebroid of X .

Therefore the Lie integration of \mathfrak{P} is the fundamental groupoid of X , which, since we have assumed global Darboux coordinates and hence contractible X , is just the pair groupoid:

$$\tau_1 \exp(\mathfrak{P}) = \Pi_1(X) = (X \times X \rightrightarrows X).$$

It remains to show that the symplectic form on \mathfrak{P} makes this a symplectic groupoid.

Notice that in the new basis the invariant polynomial reads

$$\begin{aligned} \omega &= -\omega_{ij}\mathbf{d}x^i \wedge \mathbf{d}\partial^j \\ &= \mathbf{d}(\omega_{ij}\partial^i \wedge \mathbf{d}x^j). \end{aligned}$$

The corresponding ∞ -Chern-Weil homomorphism, 4.4.17, that we need to compute is given by the ∞ -anafunctor

$$\begin{array}{ccc} \exp(\mathfrak{P})_{\text{diff}} & \xrightarrow{\exp(\omega)} & \exp(b^3\mathbb{R})_{\text{dR}} \xrightarrow{f_{\Delta^\bullet}} b_{\text{dR}}\mathbf{B}^3\mathbb{R} . \\ \downarrow \simeq & & \\ \exp(\mathfrak{P}) & & \end{array}$$

Over a test space $U \in \text{CartSp}$ and in degree 1 an element in $\exp(\mathfrak{P})_{\text{diff}}$ is a pair (X^i, η^i)

$$\begin{aligned} X^i &\in C^\infty(U \times \Delta^1) \\ \eta^i &\in \Omega_{\text{vert}}^1(U \times \Delta^1) \end{aligned}$$

subject to the constraint that along Δ^1 we have

$$d_{\Delta^1}X^i + \eta_{\Delta^1}^i = 0.$$

The vertical morphism $\exp(\mathfrak{P})_{\text{diff}} \rightarrow \exp(\mathfrak{P})$ has in fact a section whose image is given by those pairs for which η^i has no leg along U . We therefore find the desired form on $\exp(\mathfrak{P})$ by evaluating the top morphism on pairs of this form.

Such a pair is taken by the top morphism to

$$\begin{aligned} (X^i, \eta^j) &\mapsto \int_{\Delta^1} \omega_{ij} F_{X^i} \wedge F_{\partial^j} \\ &= \int_{\Delta^1} \omega_{ij} (d_{dR} X^i + \eta^i) \wedge d_{dR} \eta^j \in \Omega^3(U) \end{aligned}$$

Using the above constraint and the condition that η^i has no leg along U , this becomes

$$\dots = \int_{\Delta^1} \omega_{ij} d_U X^i \wedge d_U d_{\Delta^1} X^j.$$

By the Stokes theorem the integration over Δ^1 yields

$$\begin{aligned} \dots &= \omega_{ij} d_{dR} X^i \wedge d_{dR} X^j|_0 - \omega_{ij} d_{dR} X^i \wedge d_{dR} X^j|_1 \\ &= \partial_1^* \omega - \partial_0^* \omega \end{aligned}$$

□

5.4 Higher prequantum geometry

We discuss here the application of cohesive higher prequantum geometry, 3.9.13, to the natural action functionals that we consider in 5.5 and 5.6.

This section draws from [FRS13a].

Since in higher prequantum theory local Lagrangians are “fully de-transgressed” to higher prequantum bundles, conversely every example induces its corresponding transgressions. In the following we always start with a higher extended Chern-Simons-type theory and consider then its first transgression. As in the discussion in [FSS13a] this first transgression is the higher prequantum bundle of the topological sector of a higher extended Wess-Zumino-Witten type theory. In this way our examples appear at least in pairs as shown in the following table:

	Higher CS-type theory	higher WZW-type theory
5.4.1	3d G -Chern-Simons theory	2d WZW-model on G
5.4.2	∞ -CS theory from L_∞ -integration	
5.4.3	2d Poisson Chern-Simons theory	1d quantum mechanics
5.4.4	7d String-Chern-Simons theory	6d theory related to M5-brane

5.4.1 Higher prequantum 2d WZW model and the smooth string 2-group

In 3.9.13 we remarked that an old motivation for what we call higher prequantum geometry here is the desire to “de-transgress” the traditional construction of positive energy loop group representations of simply connected compact Lie groups G by, in our terminology, regarding the canonical $\mathbf{B}U(1)$ -2-bundle on G (the “WZW gerbe”) as a prequantum 2-bundle. Here we discuss how prequantum 2-states for the WZW sigma-model provide at least a partial answer to this question. Then we analyze the quantomorphism 2-group of this model.

For G a connected and simply connected compact Lie group such as $G = \text{Spin}(n)$ for $n \geq 3$ or $G = \text{SU}(n)$, the first nontrivial cohomology class of the classifying space BG is in degree 4: $H^4(BG, \mathbb{Z}) \simeq \mathbb{Z}$. For $\text{Spin}(n)$ the generator here is known as the *first fractional Pontryagin class* $\frac{1}{2}p_1$, while for $\text{SU}(n)$ it is the second Chern class c_2 . In [FSS10] was constructed a smooth and differential lift of this class to the ∞ -topos $\text{Smooth}\infty\text{Grpd}$, namely a diagram of smooth higher moduli stacks of the form

$$\begin{array}{ccc|ccc}
 \mathbf{BSpin}_{\text{conn}} & \xrightarrow{\frac{1}{2}\widehat{p}_1} & \mathbf{B}^3U(1)_{\text{conn}} & \nabla_{\text{CS}} & \mathbf{BSU}_{\text{conn}} & \xrightarrow{\widehat{c}_2} & \mathbf{B}^3U(1)_{\text{conn}} \\
 \downarrow u_{\mathbf{BSpin}} & & \downarrow u_{\mathbf{B}^2U(1)} & & \downarrow u_{\mathbf{BSU}} & & \downarrow u_{\mathbf{B}^2U(1)} \\
 \mathbf{BSpin} & \xrightarrow{\frac{1}{2}p_1} & \mathbf{B}^3U(1) & \nabla_{\text{CS}}^0 & \mathbf{BSU} & \xrightarrow{c_2} & \mathbf{B}^3U(1) \\
 \downarrow f & & \downarrow f & & \downarrow f & & \downarrow f \\
 \mathbf{BSpin} & \xrightarrow{\frac{1}{2}p_1} & K(\mathbb{Z}, 4) & \int \nabla_{\text{CS}}^0 & \mathbf{BSU} & \xrightarrow{c_2} & K(\mathbb{Z}, 4)
 \end{array}$$

Here f is the geometric realization map, and $u_{(-)}$ is the forgetful map from the higher moduli stacks of higher principal connections to that of higher principal bundles of def. 4.4.85.

In 5.5.5 we discuss that this 3-connection on the smooth moduli stack of G -principal connections – which for unspecified G we now denote by ∇ – is the full de-transgression of the (off-shell) prequantum 1-bundle of G -Chern-Simons theory, hence is the localized incarnation of 3d G -Chern-Simons theory in higher prequantum theory. In particular it is a $\mathbf{B}^2U(1)$ -prequantization, according to def. 4.4.85, of the Killing form invariant polynomial $\langle -, - \rangle$ of G , which is a differential 4-form (hence a *pre-3-plectic form* in the sense

of def. 1.2.275) on the moduli stack of fields:

$$\begin{array}{ccc} & & \mathbf{B}^3U(1)_{\text{conn}} \\ & \nearrow \nabla_{\text{CS}} & \downarrow F_{(-)} \\ \mathbf{B}G_{\text{conn}} & \xrightarrow{\langle F_{(-)}, F_{(-)} \rangle} & \Omega_{\text{cl}}^4 \end{array} \cdot$$

This 3-connection on the moduli stack of G -principal connections does not descend to the moduli stack $\mathbf{B}G$ of just G -principal bundles; it does however descend [Wal08] as a “3-connection without top-degree forms” as in def. 4.4.73:

$$\begin{array}{ccc} & & \mathbf{B}(\mathbf{B}^2U(1)_{\text{conn}}) \\ & \nearrow \nabla_{\text{CS}}^2 & \downarrow \mathbf{B}F_{(-)} \\ \mathbf{B}G & \longrightarrow & \mathbf{B}\Omega_{\text{cl}}^3 \end{array} \cdot$$

Therefore over the universal moduli stack of Chern-Simons fields $\mathbf{B}G_{\text{conn}}$ we canonically have a higher quantomorphism groupoid $\text{At}(\nabla_{\text{CS}})_\bullet$ as in 3.9.13.5, while over the universal moduli stack of just the “instanton sectors” of fields we have just a Courant 3-groupoid $\text{At}(\nabla_{\text{CS}}^2)_\bullet$ as in 3.9.13.6. This kind of phenomenon we re-encounter below in 5.4.3.

By the above and following [CJMSW05], the transgression of ∇_{CS} to maps out of the circle S^1 is found to be the “WZW gerbe”, the canonical circle 2-bundle with connection ∇_{WZW} on the Lie group G itself. We may obtain this either as the fiber integration of ∇_{CS} restricted along the inclusion of G as the constant \mathfrak{g} -connection on the circle

$$\nabla_{\text{WZW}} : G \longrightarrow [S^1, \mathbf{B}G_{\text{conn}}] \xrightarrow{[S^1, \nabla_{\text{CS}}]} [S^1, \mathbf{B}^3U(1)_{\text{conn}}] \xrightarrow{\exp(2\pi i \int_{S^1} (-))} \mathbf{B}^2U(1)_{\text{conn}}$$

or equivalently we obtain it as the looping of ∇_{CS}^2 :

$$\nabla_{\text{WZW}} : G \simeq \Omega \mathbf{B}G \xrightarrow{\Omega \nabla_{\text{CS}}^2} \Omega \mathbf{B}(\mathbf{B}^2U(1)_{\text{conn}}) \simeq \mathbf{B}^2U(1)_{\text{conn}} \cdot$$

This ∇_{WZW} is the background gauge field of the 2d Wess-Zumino-Witten sigma-model, the “Kalb-Ramon B-field” under which the string propagating on G is charged. We now regard this as the $\mathbf{B}U(1)$ -prequantization (def. 4.4.85) of the canonical 3-form $\langle -, [-, -] \rangle$ on G (a 2-plectic form):

$$\begin{array}{ccc} & & \mathbf{B}^2U(1)_{\text{conn}} \\ & \nearrow \nabla_{\text{WZW}} & \downarrow F_{(-)} \\ G & \xrightarrow{\langle -, [-, -] \rangle} & \Omega_{\text{cl}}^3 \end{array} \cdot$$

By example 1.2.88 the prequantum 2-states of the prequantum 2-bundle ∇_{WZW} are twisted unitary bundles with connection (twisted K-cocycles, after stabilization): the *Chan-Paton gauge fields*. More explicitly, with the notation as introduced there, a prequantum 2-state Ψ of the WZW model supported over a D-brane submanifold $Q \hookrightarrow G$ is a map $\Psi : \nabla_{\text{WZW}}|_Q \rightarrow \mathbf{d}\mathbf{d}_{\text{conn}}$ in the slice over $\mathbf{B}^2U(1)_{\text{conn}}$, hence a diagram of the form

$$\begin{array}{ccc} Q & \xrightarrow{\Psi} & \coprod_n (\mathbf{B}U(n) // \mathbf{B}U(1))_{\text{conn}} \\ \downarrow & \nearrow \nabla_{\text{WZW}} & \downarrow \\ G & \xrightarrow{[S^1, \mathbf{B}G_{\text{conn}}]} & \mathbf{B}^2U(1)_{\text{conn}} \\ \downarrow & \searrow \text{conc.} & \downarrow \exp(\int_{S^1} [S^1, \nabla]) \\ G //_{\text{ad}} G & \xrightarrow{\cong} & G\text{Conn}(S)^1 \end{array} \cdot$$

Here we have added at the bottom the map to the differential concretification of the transgressed moduli stack of fields, according to example 4.4.16.3.1. As indicated, this exhibits G as fibered over its homotopy quotient by its adjoint action. The D-brane inclusion $Q \rightarrow G$ in the diagram is the homotopy fiber over a full point of $G//_{\text{ad}}G$ precisely if it is a conjugacy class of G , hence a “symmetric D-brane” for the WZW model. In summary this means that this single diagram exhibiting WZW prequantum-2-states as slice maps encodes all the WZW D-brane data as discussed in the literature [Ga04]. In particular, in [FSS13a] we showed that the transgression of these prequantum 2-states Ψ to prequantum 1-states over the loop group LG naturally encodes the anomaly cancellation of the open bosonic string in the presence of D-branes (the Kapustin-part of the Freed-Witten-Kapustin quantum anomaly cancellation).

We may now study the quantomorphism 2-group of ∇_{WZW} , def. 3.9.86, on these 2-states, hence, in the language of twisted cohomology, the 2-group of twist automorphism. First, one sees that by inspection that this is the action that integrates and globalizes the D-brane gauge transformations which are familiar from the string theory literature, where the local connection 1-form A on the twisted bundle is shifted and the local connection 2-form on the prequantum bundle transforms as

$$A \mapsto A + \lambda, \quad B \mapsto B + d\lambda.$$

In order to analyze the quantomorphism 2-group here in more detail, notice that since the 2-plectic form $\langle -, [-, -] \rangle \in \Omega_{\text{cl}}^3(G)$ is a left invariant form (by definition), the left action of G on itself is Hamiltonian, in the sense of def. 3.9.88, and so we have the corresponding Heisenberg 2-group $\mathbf{Heis}(G, \nabla_{\text{WZW}})$ of def. 3.9.88 inside the quantomorphism 2-group. By theorem 3.9.89 this is a 2-group extension of G of the form

$$U(1)\mathbf{FlatConn}(G) \longrightarrow \mathbf{Heis}(\nabla_{\text{WZW}}) \longrightarrow G .$$

Since G is connected and simply connected, there is by prop. 3.9.92 an equivalence of smooth 2-groups $U(1)\mathbf{FlatConn}(G) \simeq \mathbf{BU}(1)$ and so the WZW Heisenberg 2-group is in fact a smooth circle 2-group extension

$$\mathbf{BU}(1) \longrightarrow \mathbf{Heis}(\nabla_{\text{WZW}}) \longrightarrow G$$

classified by a cocycle $\mathbf{B}(\nabla_{\text{WZW}} \circ (-)) : \mathbf{BG} \rightarrow \mathbf{B}^3U(1)$. If G is compact and simply connected, then, by the discussion in 4.4.6.2, $\pi_0\mathbf{H}(\mathbf{BG}, \mathbf{B}^3U(1)) \simeq H^4(BG, \mathbb{Z}) \simeq \mathbb{Z}$. This integer is the *level*, the cocycle corresponding to the generator ± 1 is $\frac{1}{2}\mathbf{p}_1$ for $G = \text{Spin}$ and \mathbf{c}_2 for $G = SU$. The corresponding extension is the String 2-group extension, def. 5.1.10

$$\mathbf{BU}(1) \longrightarrow \text{String}_G \longrightarrow G .$$

Accordingly, under Lie differentiation, one finds, that the Heisenberg Lie 2-algebra extension of theorem 3.9.13.5 combined with def. 3.9.13.5 is the *string Lie 2-algebra* extension

$$\mathbf{B}\mathbb{R} \longrightarrow \underset{\simeq}{\mathfrak{Heis}_{\langle -, [-, -] \rangle}(\mathfrak{g})} \longrightarrow \mathfrak{g} .$$

$\text{string}_{\mathfrak{g}}$

More in detail, using the results of 4.4.20.4:

Example 5.4.1. Let G be a (connected) compact simple Lie group, regarded as a 2-plectic manifold with its canonical 3-form $\omega := \langle -, [-, -] \rangle$ as in example 4.4.137. The infinitesimal generators of the action of G on itself by right translation are the left invariant vector fields \mathfrak{g} , which are Hamiltonian. We have $H_{\text{dR}}^1(G) \cong H_{\text{CE}}^1(\mathfrak{g}, \mathbb{R}) = 0$, and therefore a weak equivalence:

$$\mathbf{BH}(G, \mathfrak{b}\mathbf{B}\mathbb{R}) \xrightarrow{\simeq} \mathbb{R}[2]$$

given by the evaluation at the identity element of G . The resulting composite cocycle

$$\langle -, [-, -] \rangle : \mathfrak{g} \xrightarrow{\rho} \mathfrak{X}_{\text{Ham}}(X) \xrightarrow{\omega[\bullet]} \mathbb{R}[2]$$

is exactly the 3-cocycle which classifies the String Lie-2-algebra, namely just $\langle -, [-, -] \rangle$ regarded as a Lie algebra 3-cocycle. The String Lie 2-algebra, def. 5.1.15, is the homotopy fiber of this cocycle, in that we have a homotopy pullback square of L_∞ -algebras

$$\begin{array}{ccc} \mathfrak{string}_{\mathfrak{g}} & \longrightarrow & 0 \\ \downarrow & & \downarrow \\ \mathfrak{g} & \xrightarrow{\langle -, [-, -] \rangle} & \mathbb{R}[2] \end{array} .$$

Hence the String Lie 2-algebra is the Heisenberg Lie 2-algebra of the 2-plectic manifold $(G, \langle -, [-, -] \rangle)$ with its canonical \mathfrak{g} -action ρ :

$$\mathfrak{heis}_{\rho}(\mathfrak{g}) \simeq \mathfrak{string}_{\mathfrak{g}} .$$

The relationship between $\mathfrak{string}_{\mathfrak{g}}$ and $L_\infty(G, \omega)$ was first explored in [BaRo09].

Remark 5.4.2. This result means that given a G -principal bundle

$$\begin{array}{ccc} G & \longrightarrow & P \\ & & \downarrow \\ & & X \xrightarrow{g} \mathbf{B}G \end{array} ,$$

then a lift of the modulating map g through the String 2-group extension is precisely the structure needed to construct a circle 2-connection ∇_{glob} on the total space P such that it restricts on each fiber to the WZW-2-connection

$$\begin{array}{ccccc} & & \nabla_{\text{wzw}} & & \\ & \curvearrowright & & \curvearrowleft & \\ G & \longrightarrow & P & \xrightarrow{\nabla_{\text{glob}}} & \mathbf{B}^2U(1)_{\text{conn}} \\ & & \downarrow & & \\ & & X & \xrightarrow{g} & \mathbf{B}G \end{array} .$$

At the level of the induced action functionals, essentially this was observed [DiSh07]. If $G = \text{Spin} \times (E_8 \times E_8)$ or similar, and if g modulates the tangent bundle of X and a gauge bundle, then the obstruction to such a lift is, by 5.1, the combination of $\frac{1}{2}p_1$ and c_2 , by the discussion in 5.1. One may interpret the bundle of WZW models on P as the internal degrees of freedom of a heteric string on spacetime X and recovers a (another) geometric interpretation of the Green-Schwarz anomaly, 5.1.

5.4.2 Higher prequantum nd Chern-Simons-type theories and L_∞ -algebra cohomology

The construction of the higher prequantum bundle ∇_{CS} for Chern-Simons field theory in 5.4.1 above follows a general procedure – which might be called *differential Lie integration of L_∞ -cocycles* – that produces a whole class of examples of natural higher prequantum geometries: namely those *extended higher Chern-Simons-type field theories* which are encoded by an L_∞ -invariant polynomial on an L_∞ -algebra, in generalization of how ordinary G -Chern-Simons theory for a simply connected simple Lie group G is all encoded by the Killing form invariant polynomial (and as opposed to for instance to the cup product higher $U(1)$ -Chern-Simons theories. Since also the following two examples in 5.4.3 and 5.4.4 are naturally obtained this way, we here briefly recall this construction, due to [FSS10], with an eye towards its interpretation in higher prequantum geometry.

Given an L_∞ -algebra $\mathfrak{g} \in L_\infty$, there is a natural notion of sheaves of (flat) \mathfrak{g} -valued smooth differential forms

$$\Omega_{\text{flat}}(-, \mathfrak{g}) \hookrightarrow \Omega(-, \mathfrak{g}) \in \text{Sh}(\text{SmothMfd}),$$

and this is functorial in \mathfrak{g} (for the correct (“weak”) homomorphisms of L_∞ -algebras). Therefore there is a functor – denoted $\exp(-)$ in [FSS10] – which assigns to an L_∞ -algebra \mathfrak{g} the presheaf of Kan complexes that over a test manifold U has as set of k -cells the set of those smoothly U -parameterized collections of flat \mathfrak{g} -valued differential forms on the k -simplex Δ^k which are sufficiently well behaved towards the boundary of the simplex (have “sitting instants”). Under the presentation $L_{\text{lie}}[\text{SmoothMfd}^{\text{op}}] \simeq \text{Smooth}\infty\text{Grpd}$ of the ∞ -topos of smooth ∞ -groupoids this yields a Lie integration construction from L_∞ -algebras to smooth ∞ -groupoids. (So far this is the fairly immediate stacky and smooth refinement of a standard construction in rational homotopy theory and deformation theory, see the references in [FSS10] for a list of predecessors of this construction.)

In higher analogy to ordinary Lie integration, one finds that $\exp(\mathfrak{g})$ is the “geometrically ∞ -connected” Lie integration of \mathfrak{g} : the geometric realization $\int \exp(\mathfrak{g})$, of $\exp(\mathfrak{g}) \in L_{\text{lie}}[\text{SmoothMfd}^{\text{op}}, \text{KanCplx}] \simeq \text{Smooth}\infty\text{Grpd}$ is always contractible. For instance for $\mathfrak{g} = \mathbb{R}[-n+1] = \mathbf{B}^{n-1}\mathbb{R}$ the abelian L_∞ -algebra concentrated on \mathbb{R} in the n th degree, we have

$$\exp(\mathbb{R}[-n+1]) \simeq \mathbf{B}^n\mathbb{R} \in \text{Smooth}\infty\text{Grpd}$$

and it follows that $\int \mathbf{B}^n\mathbb{R} \simeq B^n\mathbb{R} \simeq *$. Geometrically non- ∞ -connected Lie integrations of \mathfrak{g} arise notably as truncations of the ∞ -stack $\exp(\mathfrak{g})$, 3.6.2. For instance for \mathfrak{g}_1 an ordinary Lie algebra, then the 1-truncation of the ∞ -stack $\exp(\mathfrak{g}_1)$ to a stack of 1-groupoids reproduces (the internal delooping of) the simply connected Lie group G corresponding to \mathfrak{g} by ordinary Lie theory:

$$\tau_1 \exp(\mathfrak{g}_1) \simeq \mathbf{B}G \in \text{Smooth}\infty\text{Grpd}.$$

Similarly for $\mathfrak{string} \in L_\infty\text{Alg}$ the string Lie 2-algebra, def. 1.2.181, the 2-truncation of its universal Lie integration to a stack of 2-groupoids reproduces the moduli stack of String-principal 2-bundles:

$$\tau_2 \exp(\mathfrak{string}) \simeq \mathbf{B}\text{String} \in \text{Smooth}\infty\text{Grpd}.$$

Now the simple observation that yields the analogous Lie integration of L_∞ -cocycles is that a degree- n L_∞ -cocycle μ on an L_∞ -algebra \mathfrak{g} is equivalently a map of L_∞ -algebras of the form

$$\mu : \mathbf{B}\mathfrak{g} \rightarrow \mathbf{B}^n\mathbb{R};$$

and since $\exp(-)$ is a functor, every such cocycle immediately integrates to a morphism

$$\exp(\mu) : \exp(\mathfrak{g}) \rightarrow \mathbf{B}^n\mathbb{R}$$

in $\text{Smooth}\infty\text{Grpd}$, hence to a universal cocycle on the smooth moduli ∞ -stack $\exp(\mathfrak{g})$. Moreover, this cocycle descends to the n -truncation of its domain as a \mathbb{R}/Γ cocycle on the resulting moduli n -stack

$$\exp(\mu) : \tau_n \exp(\mathfrak{g}) \rightarrow \mathbf{B}^n(\mathbb{R}/\Gamma),$$

where $\Gamma \hookrightarrow \mathbb{R}$ is the period lattice of the cocycle μ .

For instance for

$$\langle -, [-, -] \rangle : \mathbf{B}\mathfrak{g}_1 \rightarrow \mathbf{B}^3\mathbb{R}$$

the canonical 3-cocycle on a semisimple Lie algebra (where $\langle -, - \rangle$ is the Killing form invariant polynomial as before), its period group is $\pi_3(G) \simeq \mathbb{Z}$ of the simply connected Lie group G integrating \mathfrak{g}_1 , and hence the Lie integration of the 3-cocycle yields a map of smooth ∞ -stacks of the form

$$\exp(\langle -, [-, -] \rangle) : \mathbf{B}G \xrightarrow{\simeq} \tau_3 \exp(\mathfrak{g}_1) \quad \mathbf{B}^3(\mathbb{R}/\mathbb{Z}) = \mathbf{B}^3U(1),$$

where we use that for the connected and simply connected Lie group G not only the 1-truncation but also still the 3-truncation of $\exp(\mathfrak{g}_1)$ gives the delooping stack: $\tau_3 \exp(\mathfrak{g}_1) \simeq \tau_2 \exp(\mathfrak{g}_1) \simeq \tau_1 \exp(\mathfrak{g}_1) \simeq \mathbf{B}G$.

Indeed, this is what yields the refinement of the generator $c : BG \rightarrow K(\mathbb{Z}, 4)$ to smooth cohomology, which we used above in 5.4.1, for instance for $\mathfrak{g}_1 = \mathfrak{so}$ the Lie algebra of the Spin group, the Lie integration of its canonical Lie 3-cocycle

$$\exp(\langle -, [-, -] \rangle_{\mathfrak{so}}) \simeq \frac{1}{2} \mathbf{p}_1$$

yields the smooth refinement of the first fractional universal Pontryagin class.

This is shown in [FSS10] by further refining the $\exp(-)$ -construction to one that yields not just moduli ∞ -stacks of G -principal ∞ -bundles, but yields their differential refinements. The key to this construction is the observation that an invariant polynomial $\langle -, \dots, - \rangle$ on a Lie algebra and more generally on an L_∞ -algebra \mathfrak{g} yields a *globally* defined (hence invariant) differential form on the moduli ∞ -stack $\mathbf{B}G_{\text{conn}}$:

$$\langle F_{(-)}, \dots, F_{(-)} \rangle : \mathbf{B}G_{\text{conn}} \rightarrow \Omega_{\text{cl}}^{n+1}.$$

In components this is simply given, as the notation is supposed to indicate, by sending a G -principal connection ∇ first to its \mathfrak{g} -valued curvature form F_∇ and then evaluating that in the invariant polynomial. In fact this property is part of the *definition* of $\mathbf{B}G_{\text{conn}}$ for the non-braided ∞ -groups G . This we think of as a higher analog of Chern-Weil theory in higher differential geometry. We may also usefully think of the invariant polynomial $\langle F_{(-)}, \dots, F_{(-)} \rangle$ as being a pre n -plectic form on the moduli stack $\mathbf{B}G_{\text{conn}}$, in evident generalization of the terminology for smooth manifolds in def. 1.2.275.

Using this, there is a differential refinement $\exp(-)_{\text{conn}}$ of the $\exp(-)$ -construction, which lifts this pre- n -plectic form to differential cohomology and hence provides its pre-quantization, according to def. 4.4.85:

$$\begin{array}{ccc} & & \mathbf{B}^n(\mathbb{R}/\Gamma)_{\text{conn}} \\ & \nearrow^{\exp(\mu)_{\text{conn}}} & \downarrow F_{(-)} \\ \tau_n \exp(\mathfrak{g})_{\text{conn}} & \xrightarrow{\langle F_{(-)} \wedge \dots \wedge F_{(-)} \rangle} & \Omega_{\text{cl}}^{n+1} \end{array} .$$

Here the higher stack $\exp(-)_{\text{conn}}$ assigns to a test manifold U smoothly U -parameterized collections of simplicial L_∞ -Ehresmann connections: the k -cells of $\exp(\mathfrak{g})_{\text{conn}}$ are \mathfrak{g} -valued differential forms A on $U \times \Delta^k$ (now not necessarily flat) satisfying an L_∞ -analog of the two conditions on a traditional Ehresmann connection 1-form: restricted to the fiber (hence the simplex) the L_∞ -form datum becomes flat, and moreover the curvature invariants $\langle F_A \wedge \dots \wedge F_A \rangle$ obtained by evaluating the L_∞ -curvature forms in all L_∞ -invariant polynomials descends down the simplex bundle $U \times \Delta^k \rightarrow U$.

For example the differential refinement of the prequantum 3-bundle of 3d G -Chern-Simons theory $\frac{1}{2} \mathbf{p}_1 \simeq \tau_3 \exp(\langle -, [-, -] \rangle)$ obtained this way is the universal Chern-Simons 3-connection

$$\exp(\langle -, [-, -] \rangle_{\mathfrak{so}})_{\text{conn}} \simeq \frac{1}{2} \hat{\mathbf{p}}_1 : \mathbf{B}\text{Spin}_{\text{conn}} \rightarrow \mathbf{B}^3U(1)_{\text{conn}}$$

whose transgression to codimension 0 is the standard Chern-Simons action functional, as discussed above in 5.4.1. Analogously, the differential Lie integration of the next cocycle, the canonical 7-cocycle, but now regarded as a cocycle on \mathbf{string} , yields a prequantum 7-bundle on the moduli stack of String-principal 2-connections:

$$\exp(\langle -, [-, -], [-, -], [-, -] \rangle_{\mathfrak{so}})_{\text{conn}} \simeq \frac{1}{6} \hat{\mathbf{p}}_2 : \mathbf{B}\text{String}_{\text{conn}} \rightarrow \mathbf{B}^7U(1)_{\text{conn}}.$$

This defines a 7-dimensional nonabelian Chern-Simons theory, which we come to below in 5.4.4.

In conclusion this means that L_∞ -algebra cohomology is a direct source of higher smooth $(\mathbf{B}^{n-1}(\mathbb{R}/\Gamma))$ -prequantum geometries on higher differential moduli stacks. For μ any degree- n L_∞ -cocycle on an L_∞ -algebra \mathfrak{g} , differential Lie integration yields the higher prequantum bundle

$$\exp(\mu)_{\text{conn}} : \tau_n \exp(\mathfrak{g})_{\text{conn}} \rightarrow \mathbf{B}^n(\mathbb{R}/\Gamma).$$

Moreover, these are by construction higher prequantum bundles for higher Chern-Simons-type higher gauge theories in that their transgression to codimension 0

$$\exp\left(\int_{\Sigma_n} [\Sigma_n, \exp(\mu)_{\text{conn}}]\right) : [\Sigma_n, \tau_n \exp(\mathfrak{g})_{\text{conn}}] \longrightarrow \mathbb{R}/\Gamma$$

is an action functional on the stack of \mathfrak{g} -gauge fields A on a given closed oriented manifold Σ_n which is locally given by the integral of a Chern-Simons $(n-1)$ -form $\text{CS}_\mu(A)$ (with respect to the corresponding L_∞ -invariant polynomial) and globally given by a higher-gauge consistent globalization of such integrals.

All of this discussion generalizes verbatim from L_∞ -algebras to L_∞ -algebroids, too. In [FRS11] it was observed that therefore all the perturbative field theories known as *AKSZ sigma-models* have a Lie integration to what here we call higher prequantum bundles for higher Chern-Simons type field theories: these are precisely the cases as above where μ transgresses to a binary invariant polynomial $\langle -, - \rangle$ on the L_∞ -algebroid which non-degenerate. In the next section 5.4.3 we consider one low-dimensional example in this family and observe that its higher geometric prequantum and quantum theory has secretly been studied in some detail already – but in 1-geometric disguise.

For higher Chern-Simons action functionals $\exp(\mu)_{\text{conn}}$ as above, one finds that their variational differential at a field configuration A given by globally defined differential form data is proportional to

$$\delta \exp\left(\int_{\Sigma_{n-1}} [\Sigma_n, \exp(\mu)_{\text{conn}}]\right) \propto \int_{\Sigma} \langle F_A \wedge \dots \wedge F_A \wedge \delta A \rangle.$$

Therefore the Euler-Lagrange equations of motion of the corresponding n -dimensional Chern-Simons theory assert that

$$\langle F_A \wedge \dots \wedge F_A, - \rangle = 0.$$

(Notice that in general F_A is an inhomogenous differential form, so that this equation in general consists of several independent components.) In particular, if the invariant polynomial is binary, hence of the form $\langle -, - \rangle$, and furthermore non-degenerate (this is precisely the case in which the general ∞ -Chern-Simons theory reproduces the AKSZ σ -models), then the above equations of motion reduce to

$$F_A = 0$$

and hence assert that the critical/on-shell field configurations are precisely those L_∞ -algebroid valued connections which are flat.

In this case the higher moduli stack $\tau_n \exp(\mathfrak{g})$, which in general is the moduli stack of instanton/charge-sectors underlying the topologically nontrivial \mathfrak{g} -connections, acquires also a different interpretation. By the above discussion, its $(n-1)$ -cells are equivalently flat \mathfrak{g} -valued connections on the $(n-1)$ -disks and its n -cells implement gauge equivalences between such data. But since the equations of motion $F_A = 0$ are first order differential equations, flat connections on D^{n-1} bijectively correspond to critical field configuration on the cylinder $D^{n-1} \times [-T, T]$. Therefore the collection of $(n-1)$ -cells of $\tau_n \exp(\mathfrak{g})$ is the higher/extended *covariant phase space* for “open genus-0 $(n-1)$ -branes” in the model. Moreover, the n -cells between these $(n-1)$ -cells implement the gauge transformations on such initial value data and hence $\tau_n \exp(\mathfrak{g})$ is, in codimension 1, the higher/extended *reduced phase space* of the model in codimension 1. For $n = 2$ this perspective was amplified in [CaFe00], we turn to this special case below in 5.4.3).

As an example, from this perspective the construction of the WZW-gerbe by looping as discussed above in 5.4.2 is equivalently the construction of the on-shell prequantum 2-bundle in codimension 2 for “Dirichlet boundary conditions” for the open Chern-Simons membrane. Namely \mathbf{BG} is now the extended reduced phase space, and so the extended phase space of membranes stretching between the unique point is the homotopy fiber product of the two point inclusions $Q_0 \longrightarrow \mathbf{BG} \longleftarrow Q_1$, with $Q_0, Q_1 = *$, hence is $\Omega \mathbf{BG} \simeq G$.

Since the on-shell prequantum 2-bundle ∇_{CS}^1 trivializes over these inclusions, as exhibited by diagrams

$$\begin{array}{ccc} Q_i & \longrightarrow & * \\ \downarrow & & \downarrow \\ \mathbf{B}G & \xrightarrow{\nabla_{\text{CS}}^2} & \mathbf{B}^3U(1)_{\text{conn}^2} \end{array} ,$$

the on-shell prequantum 3-bundle ∇_{CS}^2 extends to a diagram of relative cocycles of the form

$$\begin{array}{ccc} Q_0 & \longrightarrow & * \\ \downarrow & & \downarrow \\ \mathbf{B}G & \xrightarrow{\nabla_{\text{CS}}^2} & \mathbf{B}(\mathbf{B}^3U(1)_{\text{conn}}) \\ \uparrow & & \uparrow \\ Q_1 & \longrightarrow & * \end{array} ,$$

hence, under forming homotopy fiber products, to the WZW-2-connection $\Omega\nabla_{\text{CS}}^2 : G \rightarrow \mathbf{B}^2U(1)$ on the extended phase space G .

In the next section we see another example of this phenomenon.

5.4.3 Higher prequantum 2d Poisson-Chern-Simons theory and quantum mechanics

We consider here the boundary prequantum theory of the non-perturbative 2d Poisson-Chern-Simons theory and indicate how its quantization yields the quantization of the corresponding Poisson manifold, regarded as a boundary condition. More on this quantization is below in 6.0.4.1.

A non-degenerate and binary invariant polynomial which induces a pre-2-plectic structure on the moduli stack of a higher Chern-Simons type theory

$$\omega := \langle F_{(-)}F_{(-)} \rangle : \tau_2 \exp(\mathfrak{P})_{\text{conn}} \rightarrow \Omega_{\text{cl}}^3$$

exists precisely on Poisson Lie algebroids \mathfrak{P} , induced from Poisson manifolds (X, π) . The differential Lie integration method described above yields a $(\mathbf{B}(\mathbb{R}/\Gamma))$ -prequantization

$$\begin{array}{ccc} & \mathbf{B}^2(\mathbb{R}/\Gamma)_{\text{conn}} & \\ & \nearrow \nabla_P & \downarrow F_{(-)} \\ \tau_1 \exp(\mathfrak{P})_{\text{conn}} & \xrightarrow{\omega} & \Omega_{\text{cl}}^3 \end{array} .$$

The action functional of this higher prequantum field theory over a closed oriented 2-dimensional smooth manifold Σ_2 is, again by [FSS12c, FRS11], the transgression of the higher prequantum bundle to codimension 0

$$\exp \left(\int_{\Sigma_2} [\Sigma_2, \nabla_P] \right) : [\Sigma_2, \tau_1 \exp(\mathfrak{P})_{\text{conn}}] \longrightarrow \mathbb{R}/\Gamma .$$

We observe now that two complementary sectors of this higher prequantum 2d Poisson Chern-Simons field theory ∇_P lead a separate life of their own in the literature: on the one hand the sector where the bundle structures and hence the nontrivial “instanton sectors” of the field configurations are ignored and only the globally defined connection differential form data is retained; and on the other hand the complementary sector where only these bundle structures/ instanton sectors are considered and the connection data is ignored:

1. The restriction of the action functional $\exp(\int_{\Sigma_2} [\Sigma_2, \nabla_P])$ to the linearized theory – hence along the canonical inclusion $\Omega(\Sigma, \mathfrak{P}) \hookrightarrow [\Sigma_2, \exp(\mathfrak{P})_{\text{conn}}]$ of globally defined \mathfrak{P} -valued forms into all $\exp(\mathfrak{P})$ -principal connections – is the action functional of the *Poisson sigma-model*.
2. The restriction of the moduli stack of fields $\tau_1 \exp(\mathfrak{P})_{\text{conn}}$ to just $\tau_1 \exp(\mathfrak{P})$ obtained by forgetting the differential refinement (the connection data) and just remembering the underlying $\exp(\mathfrak{P})$ -principal bundles, yields what is known as the *symplectic groupoid* of \mathfrak{P} .

Precisely: while the prequantum 2-bundle ∇_P does not descend along the forgetful map $\tau_1 \exp(\mathfrak{P})_{\text{conn}} \rightarrow \tau_1 \exp(\mathfrak{P})$ from moduli of $\tau_1 \exp(\mathfrak{P})$ -principal connections to their underlying $\tau_1(\exp(\mathfrak{P}))$ -principal bundles, its version ∇_P^1 “without curving”, given by def. 4.4.73, does descend (this is as for 3d Chern-Simons theory discussed above in 5.4.1) and so does hence its curvature ω^1 , which has coefficients in $\mathbf{B}\Omega_{\text{cl}}^2$ instead of Ω_{cl}^3 :

$$\begin{array}{ccc}
 & \mathbf{B}(\mathbf{B}(\mathbb{R}/\Gamma)_{\text{conn}}) & \\
 \nabla_P^1 \nearrow & & \downarrow \mathbf{BF}_{(-)} \\
 \tau_1 \exp(\mathfrak{P}) & \xrightarrow{\omega^1} & \mathbf{B}\Omega_{\text{cl}}^2
 \end{array}$$

If here the smooth groupoid $\tau_1 \exp(\mathfrak{P}) \in \text{Smooth}\infty\text{Grpd}$ happens to have a presentation by a Lie groupoid under the canonical inclusion of Lie groupoids into smooth ∞ -groupoids (this is an integrability condition on \mathfrak{P}) then equipped with the de Rham hypercohomology 3-cocycle ω^1 it is called in the literature a *pre-quasi-symplectic groupoid* [LX03]. If moreover the de Rham hypercohomology 3-cocycle ω^1 – which in general is given by 3-form data and 2-form data on a Čech simplicial presheaf that resolves $\tau_1 \exp(\mathfrak{P})$ – happens to be represented by just a globally defined 2-form on the manifold of morphisms of the Lie groupoid (which is then necessarily closed and “multiplicative”), then this local data is called a (pre-)*symplectic groupoid*, see [Ha06] for a review and further pointers to the literature.

So in the case that the descended (pre-)2-plectic form $\omega^1 : \tau_1 \exp(\mathfrak{P}) \rightarrow \mathbf{B}\Omega_{\text{cl}}^2$ of the higher prequantum 2d Poisson Chern-Simons theory is represented by a multiplicative symplectic 2-form on the manifold of morphisms of the Lie groupoid $\tau_1 \exp(\mathfrak{P})$, then one is faced with a situation that looks like ordinary symplectic geometry subject to a kind of equivariance condition. This is the perspective from which symplectic groupoids were originally introduced and from which they are mostly studied in the literature (with the exception at least of [LX03], where the higher geometric nature of the setup is made explicit): as a means to re-code Poisson geometry in terms of ordinary symplectic geometry. The goal of finding a sensible geometric quantization of symplectic groupoids (and hence in some sense of Poisson manifolds, this we come back to below) was finally achieved in [Ha06].

In order to further understand the conceptual role of the prequantum 2-bundle $\nabla_{\mathfrak{P}}^1$, notice that by the discussion in 5.4.2, following [CaFe00], we may think of the symplectic groupoid $\tau_1 \exp(\mathfrak{P})$ as the extended reduced phase space of the open string Poisson-Chern-Simons theory. More precisely, if $\mathfrak{C}_0, \mathfrak{C}_1 \hookrightarrow \mathfrak{P}$ are two sub-Lie algebroids, then the homotopy fiber product $\mathbf{Phase}_{\mathfrak{C}_0, \mathfrak{C}_1}$ in

$$\begin{array}{ccc}
 & \mathbf{Phase}_{\mathfrak{C}_0, \mathfrak{C}_1} & \\
 \swarrow & & \searrow \\
 \tau_1 \exp(\mathfrak{C}_0) & & \tau_1 \exp(\mathfrak{C}_1) \\
 \searrow & & \swarrow \\
 & \tau_1 \exp(\mathfrak{P}) &
 \end{array}$$

should be the ordinary reduced phase space of open strings that stretch between \mathfrak{C}_0 and \mathfrak{C}_1 , regarded as D-branes. Unwinding the definitions shows that this is precisely what is shown in [CaFe03]: for $\mathfrak{C}_0, \mathfrak{C}_1 \hookrightarrow \mathfrak{P}$

two Lagrangian sub-Lie algebroids (hence over coisotropic submanifolds of X) the homotopy fiber product stack $\mathbf{Phase}_{\mathfrak{C}_0, \mathfrak{C}_1}$ is the symplectic reduction of the open \mathfrak{C}_0 - \mathfrak{C}_1 -string phase space.

Notice that the condition that $\mathfrak{C}_i \hookrightarrow \mathfrak{P}$ be Lagrangian sub-Lie algebroids means that restricted to them the prequantum 2-bundle becomes flat, hence that we have commuting squares

$$\begin{array}{ccc} \tau_1 \exp(\mathfrak{C}_i) & \longrightarrow & \mathfrak{b}\mathbf{B}^2(\mathbb{R}/\Gamma) \\ \downarrow & & \downarrow \\ \tau_1 \exp(\mathfrak{P}) & \xrightarrow{\nabla_P^1} & \mathbf{B}(\mathbf{B}(\mathbb{R}/\Gamma)_{\text{conn}}) \end{array} .$$

If the inclusions are even such ∇_P^1 entirely trivializes over them, hence that we have diagrams

$$\begin{array}{ccc} \tau_1 \exp(\mathfrak{C}_i) & \xrightarrow{\nabla_{\mathfrak{C}_i}} & * \\ \downarrow & & \downarrow \\ \tau_1 \exp(\mathfrak{P}) & \xrightarrow{\nabla_P^1} & \mathbf{B}(\mathbf{B}(\mathbb{R}/\Gamma)_{\text{conn}}) \end{array} ,$$

then under forming homotopy fiber products the prequantum 2-bundle ∇_P^1 induces a prequantum 1-bundle on the open string phase space by the D-brane-relative looping of the on-shell prequantum 2-bundle:

$$\nabla_{\mathfrak{C}_0} \times_{\nabla_P^1} \nabla_{\mathfrak{C}_1} : \mathbf{Phase}_{\mathfrak{C}_0, \mathfrak{C}_1} \longrightarrow \mathbf{B}(\mathbb{R}/\Gamma)_{\text{conn}} .$$

We now review the steps in the geometric quantization of the symplectic groupoid due to [Ha06] – hence the full geometric quantization of the prequantization ∇_P^1 – while discussing along the way the natural re-interpretation of the steps involved from the point of view of the higher geometric prequantum theory of 2d Poisson Chern-Simons theory.

Consider therefore ∇_P^1 , as above, as the $(\mathbf{BU}(1))$ -prequantum 2-bundle of 2d Poisson Chern-Simons theory according to def. 4.4.85. If we have a genuine symplectic groupoid instead of a pre-quasi-symplectic groupoid then it makes sense ask for this prequantization to be presented by a Čech-Deligne 3-cocycle on $\tau_1 \exp(\mathfrak{P})$ which is given just by a multiplicative circle-bundle with connection on the space of morphisms of the symplectic groupoid, and otherwise trivial local data on the space of objects. While this is unlikely to be the most general higher prequantization of the 2d Poisson Chern-Simons theory, this is the choice that admits to think of the situation as if it were a setup in traditional symplectic geometry equipped with an equivariance- or “multiplicativity”-constraint, as opposed to a setup in higher 2-plectic geometry. (Such a “multiplicative circle bundle” on the space of morphisms of a Lie groupoid is just like the transition bundle that appears in the definition of a bundle gerbe, only that here the underlying groupoid is not a Čech groupoid resolving a plain manifold, but is, in general, a genuine non-trivial Lie groupoid.)

Such a multiplicative prequantum bundle is the traditional notion of prequantization of a symplectic groupoid and is also considered in [Ha06]. The central construction there is that of the convolution C^* -algebra $\mathcal{A}(\nabla^1)_{\text{pq}}$ of sections of the multiplicative prequantum bundle on the space of morphisms of the symplectic groupoid, and its subalgebra

$$\mathcal{A}(\nabla_P^1)_{\text{q}} \hookrightarrow \mathcal{A}(\nabla_P^1)_{\text{pq}}$$

of polarized sections, once a suitable kind of polarization has been chosen. Observe then that convolution algebras of sections of transition bundles of bundle gerbes have a natural interpretation in the higher geometry of the corresponding higher prequantum bundle ∇^1 : by [TXL04] and section 5 of [CJM02] these are the algebras whose modules are the unitary bundles which are twisted by ∇^1 : the “bundle gerbe modules”.

By 3.6.12 and by the discussion above in 5.4.1, ∇_P^1 -twisted unitary bundles are equivalently the (pre-)quantum 2-states of ∇_P^1 regarded as a prequantum 2-bundle. These hence form a category $\mathcal{A}(\nabla_P^1)_{\text{q}}\text{Mod}$

of modules, and such categories of modules are naturally interpreted, by the discussion in the appendix of [Sc08] as *2-modules* with *2-basis* the linear category $\mathbf{BA}(\nabla_P^1)_q$:

$$\left\{ \begin{array}{l} \text{quantum 2-states of} \\ \text{higher prequantum 2d Poisson Chern-Simons theory} \end{array} \right\} \simeq \mathcal{A}(\nabla_P^1)_q \text{Mod} \in 2\text{Mod}.$$

This resolves what might be a conceptual puzzlement concerning the construction in [Ha06] in view of the usual story of geometric quantization: ordinarily geometric quantization directly produces the space of states of a theory, while it requires more work to obtain the algebra of quantum observables acting on that. In [Ha06] it superficially seems to be the other way around, an algebra drops out as a direct result of the quantization procedure. However, from the point of view of higher prequantum geometry this algebra *is* (a 2-basis for) the 2-space of 2-states; and indeed obtaining the *2-algebra* or *higher quantum operators* which would act on these 2-states does require more work (and has not been discussed yet).

Of course [Ha06] amplifies a different perspective on the central result obtained there: that $\mathcal{A}(\nabla_P^1)_q$ is also a *strict C^* -deformation quantization* of the Poisson manifold that corresponds to the Poisson Lie algebroid $\mathfrak{P}!$ From the point of view of higher prequantum theory this says that the higher-geometric quantized 2d Poisson Chern-Simons theory has a 2-space of quantum 2-states in codimension 2 that encodes the correlators (commutators) of a 1-dimensional quantum mechanical system. In other words, we see that the construction in [Ha06] is implicitly a “holographic” (strict deformation-)quantization of a Poisson manifold by directly higher-geometric quantizing instead a 2-dimensional QFT.

Notice that this statement is an analogue in C^* -deformation quantization to the seminal result on *formal* deformation quantization of Poisson manifolds: The general formula that Kontsevich had given for the formal deformation quantization of a Poisson manifold was found by Cattaneo-Felder to be the point-particle limit of the 3-point function of the corresponding 2d Poisson sigma-model [CaFe00]. A similar result is discussed in [GK08]. There the 2d A-model (which is a special case of the Poisson sigma-model) is shown to holographically encode the quantization of its target space symplectic manifold regarded as a 1d quantum field theory.

In summary, the following table indicates how the “holographic” formal deformation quantization of Poisson manifolds by Kontsevich-Cattaneo-Felder is analogous to the “holographic” strict deformation quantization of Poisson manifolds by [Ha06], when reinterpreted in higher prequantum theory as discussed above.

	perturbative formal algebraic quantization	non-perturbative geometric quantization
quantization of Poisson manifold	formal deformation quantization	strict C^* -deformation quantization
“holographically” related 2d field theory	Poisson sigma-model	2d Poisson Chern-Simons theory
moduli stack of fields of the 2d field theory	Poisson Lie algebroid	symplectic groupoid
quantization of holographically related 2d field theory	perturbative quantization of Poisson sigma-model	higher geometric quantization of 2d Poisson Chern-Simons theory
1d observable algebra is holographically identified with...	point-particle limit of 3-point function	basis for 2-space of quantum 2-states

More details on this higher geometric interpretation of traditional symplectic groupoid quantization are discussed below in 6.

5.4.4 Higher prequantum 6d WZW-type models and the smooth fivebrane-6-group

We close the overview of examples by providing a brief outlook on higher dimensional examples in general, and on certain higher prequantum field theories in dimensions seven and six in particular.

To appreciate the following pattern, recall that in 5.4.1 above we discussed how the universal G -Chern-Simons $(\mathbf{B}^2U(1))$ -principal connection ∇_{CS} over $\mathbf{B}G_{\text{conn}}$ transgresses to the Wess-Zumino-Witten $\mathbf{B}U(1)$ -principal connection ∇_{WZW} on G itself. At the level of the underlying principal ∞ -bundles ∇_{CS}^0 and ∇_{WZW}^0 this relation holds very generally:

for $G \in \text{Grp}(\mathbf{H})$ any ∞ -group, and $A \in \text{Grp}_{n+1}(\mathbf{H})$ any sufficiently highly deloopable ∞ -group (def. 3.6.116) in any ∞ -topos \mathbf{H} , consider a class in smooth ∞ -group cohomology, 3.6.13,

$$c \in H_{\text{grp}}^{n+1}(G, A) = H^{n+1}(\mathbf{B}G, A),$$

hence a universal characteristic class for G -principal ∞ -bundles, represented by a smooth cocycle

$$\nabla_{\text{CS}}^0 : \mathbf{B}G \longrightarrow \mathbf{B}^{n+1}A .$$

Along the above lines we may think of the corresponding $\mathbf{B}^n A$ -principal ∞ -bundle over $\mathbf{B}G$ as a *universal ∞ -Chern-Simons bundle*. By example 3.6.14 this is the delooped ∞ -group extension which is classified by ∇_{CS}^0 regarded as an ∞ -group cocycle. The looping of this cocycle exists

$$\nabla_{\text{WZW}}^0 := \Omega \nabla_{\text{CS}}^0 : G \longrightarrow \mathbf{B}^n A .$$

and modulates a $\mathbf{B}^{n-1}A$ -principal bundle over the ∞ -group G itself: the ∞ -group extension itself that is classified by ∇_{CS}^0 according to example 3.6.14. This is the corresponding WZW ∞ -bundle.

For example, for the case that $G \in \text{Grp}(\text{Smooth}\infty\text{Grpd})$ is a compact Lie group and $A = U(1)$ is the smooth circle group, then by example 4.4.6.2 there is an essentially unique refinement of every integral cohomology class $k \in H^4(BG, \mathbb{Z})$ to such a smooth cocycle $\nabla_{\text{CS}}^0 : \mathbf{B}G \rightarrow \mathbf{B}^3U(1)$. This k is the *level* of G -Chern-Simons theory and ∇_{CS}^0 modulates the corresponding higher prequantum bundle of 3d G -Chern-Simons theory as in 5.4.1 above. Moreover, the looping $\nabla_{\text{WZW}}^0 \simeq \Omega \nabla_{\text{CS}}^0$ modulates the “WZW gerbe”, as discussed there.

Now restrict attention to the next higher example of such pairs of higher Chern-Simons/higher WZW bundles, as seen by the tower of examples induced by the smooth Whitehead tower of $\mathbf{B}O$, 5.1.1: the universal Chern-Simons 7-bundle on the smooth String-2 group and the corresponding Wess-Zumino-Witten 6-bundle on String itself.

To motivate this as part of a theory of physics, first consider a simpler example of a 7-dimensional Chern-Simons type theory, namely the cup-product $U(1)$ -Chern-Simons theory in 7 dimensions, for which the “holographic” relation to an interesting 6d theory is fairly well understood. This is the theory whose de-transgression is given by the higher prequantum 7-bundle on the universal moduli 3-stack $\mathbf{B}^3U(1)_{\text{conn}}$ of $\mathbf{B}^2U(1)$ -principal connections that is modulated by the smooth and differential refinement of the cup product \cup in ordinary differential cohomology:

$$\begin{array}{ccc|c} \mathbf{B}^3U(1)_{\text{conn}} & \xrightarrow{(-)\dot{\cup}(-)} & \mathbf{B}^7U(1)_{\text{conn}} & \nabla_{7\text{AbCS}} \\ \downarrow u_{\mathbf{B}^3U(1)} & & \downarrow u_{\mathbf{B}^7U(1)} & \\ \mathbf{B}^3U(1) & \xrightarrow{(-)\cup(-)} & \mathbf{B}^7U(1) & \nabla_{7\text{AbCS}}^0 \\ \downarrow f & & \downarrow f & \\ K(\mathbb{Z}_4) & \xrightarrow{(-)\cup(-)} & K(\mathbb{Z}_8) & \int \nabla_{7\text{AbCS}}^0 \end{array} .$$

(Or rather, the theory to consider for the full holographic relation is a quadratic refinement of this cup pairing. The higher geometric refinement of this we discuss in 5.2.9, but in the present discussion we will suppress this, for simplicity).

While precise and reliable statements are getting scarce as one proceeds with the physics literature into the study of these systems, the following four seminal physics articles seem to represent the present understanding of the story by which this 7d theory is related to a 6d theory in higher generalization of how 3d Chern-Simons theory is related to the 2d WZW model.

1. In [Wi97b] it was argued that the space of states that the (ordinary) geometric quantization of $\nabla_{7\text{AbCS}}$ assigns to a closed 6d manifold Σ is naturally identified with the space of conformal blocks of a self-dual 2-form higher gauge theory on Σ . Moreover, this 6d theory is part of the worldvolume theory of a single M5-brane and the above 7d Chern-Simons theory is the abelian Chern-Simons sector of the 11-dimensional supergravity Lagrangian compactified to a 7-manifold whose boundary is the 6d M5-brane worldvolume.
2. Then in [Mald97] a more general relation between the 6d theory and 11-dimensional supergravity compactified on a 4-sphere to an asymptotically anti-de Sitter space was argued for. This is what is today called AdS₇/CFT₆-duality, a sibling of the AdS₅/CFT₄-duality which has received a large amount of attention since then.
3. As a kind of synthesis of the previous two items, in [Wi98c] it is argued for both AdS₅/CFT₄ and AdS₇/CFT₆ the conformal blocks on the CFT-side are obtained already by keeping on the supergravity side *only* the Chern-Simons terms inside the full supergravity action.
4. At the same time it is known that the abelian Chern-Simons term in the 11-dimensional supergravity action relevant for AdS₇/CFT₆ is not in general just the abelian Chern-Simons term $\nabla_{7\text{AbCS}}$ considered in the above references: more accurately it receives Green-Schwarz-type quantum corrections that make it a *nonabelian* Chern-Simons term [DLM95].

In [FSS12b] we observed that these items together, taken at face value, imply that more generally it must be the quantum-corrected nonabelian 7d Chern-Simons Lagrangian inside 11-dimensional supergravity which is relevant for the holographic description of the 2-form sector of the 6d worldvolume theory of M5-branes. (See [Fr00] for comments on this 6d theory as an extended QFT related to extended 7d Chern-Simons theory.) Moreover, in 5.2.9 we observe that the natural lift of the “flux quantization condition” [Wi97b] – which is an *equation* between cohomology classes of fields in 11d-supergravity – to moduli stacks of fields (hence to higher prequantum geometry) is given by the corresponding *homotopy pullback* of these moduli fields, as usual in homotopy theory. We showed that this homotopy pullback is the smooth moduli 2-stack $\mathbf{B}\text{String}_{\text{conn}}^{2a}$ of twisted String-principal 2-connections, unifying the Spin-connection (the field of gravity) and the 3-form C -field into a single higher gauge field in higher prequantum geometry.

The nonabelian 7-dimensional Chern-Simons-type Lagrangian on String-2-connections obtained this way in [FSS12b] is the sum of some cup product terms and one indecomposable term. Moreover, the refinement specifically of the indecomposable term to higher prequantum geometry is the stacky and differential refinement $\frac{1}{6}\hat{p}_2$ of the universal fractional second Pontryagin class $\frac{1}{2}p_2$, which was constructed in [FSS10] as reviewed in 5.4.2 above:

$$\begin{array}{ccc}
 \mathbf{B}\text{String}_{\text{conn}} & \xrightarrow{\frac{1}{6}\hat{p}_2} & \mathbf{B}^7U(1)_{\text{conn}} \\
 \downarrow u_{\mathbf{B}\text{String}} & & \downarrow p_{\mathbf{B}^7U(1)} \\
 \mathbf{B}\text{String} & \xrightarrow{\frac{1}{6}p_2} & \mathbf{B}^7U(1) \\
 \downarrow f & & \downarrow f \\
 BO\langle 8 \rangle & \xrightarrow{\frac{1}{6}p_2} & K(\mathbb{Z}, 8)
 \end{array}
 \left| \begin{array}{l}
 \nabla_{7\text{CS}} \\
 \nabla_{7\text{CS}}^0 \\
 \int \nabla_{7\text{CS}}^0
 \end{array} \right.$$

Quite independently of whatever role this extended 7d Chern-Simons theory has as a sector in AdS₇/CFT₆ duality, this is the natural next example in higher prequantum theory after that of 3d Spin-Chern-Simons theory.

In [FSS10] it was shown that the prequantum 7-bundle of this nonabelian 7d Chern-Simons theory over the moduli stack of its instanton sectors, hence over $\mathbf{B}\text{String}$, is the delooping of a smooth refinement of the

Fivebrane group, 5.2.6.4, to the smooth Fivebrane 6-group, 5.1.5:

$$\begin{array}{ccc} \mathbf{B}\text{Fivebrane} & & \\ \downarrow & & \\ \mathbf{B}\text{String} & \xrightarrow{\nabla_{7\text{CS}}^0} & \mathbf{B}^7U(1). \end{array}$$

Moreover, by the above general discussion this induces a WZW-type 6-bundle over the smooth String 2-group itself, whose total space is the Fivebrane group itself

$$\begin{array}{ccc} \text{Fivebrane} & & \\ \downarrow & & \\ \text{String} & \xrightarrow{\nabla_{6\text{WZW}}^0} & \mathbf{B}^6U(1) \end{array}$$

Therefore, in view of the discussion in 5.4.1, it is natural to expect a 6-dimensional higher analog of traditional 2d WZW theory whose underlying higher prequantum 6-bundle is $\nabla_{6\text{WZW}}$. However, the lift of this discussion from just instanton sectors to the full moduli stack of fields is more subtle than in the 3d/2d case and deserves a separate discussion elsewhere. (This is ongoing joint work with Hisham Sati.)

5.5 Higher Chern-Simons field theory

We consider the realization of the general abstract ∞ -Chern-Simons functionals from 3.9.11 in the context of smooth, synthetic-differential and super-cohesion. We discuss general aspects of the class of quantum field theories defined this way and then identify a list of special cases of interest. This section builds on [FRS13a] and [FS].

- 5.5.1 – Higher extended ∞ -Chern-Simons theory
 - 5.5.1.1 – Fiber integration and extended Chern-Simons functionals
 - 5.5.1.2 – Construction from L_∞ -cocycles
- 5.5.2 – Higher cup-product Chern-Simons theories
- Examples
 - 5.5.3 – Volume holonomy
 - 5.5.4 – 1d Chern-Simons functionals
 - 5.5.5 – 3d Chern-Simons functionals
 - * 5.5.5.1 – Ordinary Chern-Simons theory
 - * 5.5.5.3 – Ordinary Dijkgraaf-Witten theory
 - 5.5.6 – 4d Chern-Simons functionals
 - * 5.5.6.1 – 4d BF theory and topological Yang-Mills theory
 - * 5.5.6.2 – 4d Yetter model
 - 5.5.7 – Abelian gauge coupling of branes
 - 5.5.8 – Higher abelian Chern-Simons functionals
 - * 5.5.8.1 – $(4k + 3)$ d $U(1)$ -Chern-Simons functionals;
 - * 5.5.8.2 – Higher electric coupling and higher gauge anomalies.
 - 5.5.9 – 7d Chern-Simons functionals
 - * 5.5.9.1 – The cup product of a 3d CS theory with itself;
 - * 5.5.9.2 – 7d CS theory on string 2-connection fields;
 - * 5.5.9.3 – 7d CS theory in 11d supergravity on AdS_7 .
 - 5.5.8.2 – Higher electric coupling and higher gauge anomalies
 - 5.5.10 – Action of closed string field theory type
 - 5.5.11 – AKSZ σ -models
 - * 5.5.11.3 – Ordinary Chern-Simons as AKSZ theory
 - * 5.5.11.4 – Poisson σ -model
 - * 5.5.11.5 – Courant σ -model
 - * 5.5.11.6 – Higher abelian Chern-Simons theory in dimension $4k + 3$

5.5.1 ∞ -Chern-Simons field theory

By prop. 5.1.9 the action functional of ordinary Chern-Simons theory [Fr95] for a simple Lie group G may be understood as being the volume holonomy, 4.4.19, of the Chern-Simons circle 3-bundle with connection that the refined Chern-Weil homomorphism assigns to any connection on a G -principal bundle.

We may observe that all the ingredients of this statement have their general abstract analogs in any cohesive ∞ -topos \mathbf{H} : for any cohesive ∞ -group G and any representatative $\mathbf{c} : \mathbf{B}G \rightarrow \mathbf{B}^n A$ of a characteristic class for G there is canonically the induced ∞ -Chern-Weil homomorphism, 3.9.7

$$L_{\mathbf{c}} : \mathbf{H}_{\text{conn}}(-, \mathbf{B}G) \rightarrow \mathbf{H}_{\text{diff}}^n(-)$$

that sends intrinsic G -connections to cocycles in intrinsic differential cohomology with coefficients in A . This may be thought of as the *Lagrangian* of the ∞ -Chern-Simons theory induced by \mathbf{c} .

In the cohesive ∞ -topos $\text{Smooth}\infty\text{Grpd}$ of smooth ∞ -groupoids, 4.4, we deduced in 4.4.19 a natural general abstract procedure for integration of $L_{\mathbf{c}}$ over an n -dimensional parameter space $\Sigma \in \mathbf{H}$ by a realization of the general abstract construction described in 3.9.11. The resulting smooth function

$$\exp(S_{\mathbf{c}}) : [\Sigma, \mathbf{B}G_{\text{conn}}] \rightarrow U(1)$$

is the exponentiated action functional of ∞ -Chern-Simons theory on the smooth ∞ -groupoid of field configurations. It may be regarded itself as a degree-0 characteristic class on the space of field configurations. As such, its differential refinement $d \exp(S_{\mathbf{c}}) : [\Sigma, \mathbf{B}G_{\text{conn}}] \rightarrow \mathfrak{b}_{\text{dR}} \mathbf{B}U(1)$ is the Euler-Lagrange equation of the theory.

We show that this construction subsumes the action functional of ordinary Chern-Simons theory, of Dijkgraaf-Witten theory, of BF-theory coupled to topological Yang-Mills theory, of all versions of AKSZ theory including the Poisson sigma-model and the Courant sigma model in lowest degree, as well as of higher Chern-Simons supergravity.

5.5.1.1 Fiber integration and extended Chern-Simons functionals We discuss fiber integration in ordinary differential cohomology refined to smooth higher stacks and how this turns every differential characteristic maps into a tower of extended higher Chern-Simons action functionals in all codimensions.

This section draws from [FSS12c].

One of the basic properties of ∞ -toposes is that they are *cartesian closed*. This means that:

Fact 5.5.1. *For every two objects $X, A \in \mathbf{H}$ – hence for every two smooth higher stacks – there is another object denoted $[X, A] \in \mathbf{H}$ that behaves like the “space of smooth maps from X to A .” in that for every further $Y \in \mathbf{H}$ there is a natural equivalence of cocycle ∞ -groupoids of the form*

$$\mathbf{H}(X \times Y, A) \simeq \mathbf{H}(Y, [X, A]),$$

saying that cocycles with coefficients in $[X, A]$ on Y are naturally equivalent to A -cocycles on the product $X \times Y$.

Remark 5.5.2. The object $[X, A]$ is in category theory known as the *internal hom* object, but in applications to physics and stacks it is often better known as the “families version” of A -cocycles on Y , in that for each smooth parameter space $U \in \text{SmthMfd}$, the elements of $[X, A](U)$ are “ U -parameterized families of A -cocycles on X ”, namely A -cocycles on $X \times U$. This follows from the above characterizing formula and the Yoneda lemma:

$$[X, A](U) \xrightarrow[\text{Yoneda}]{\simeq} \mathbf{H}(U, [X, A]) \xrightarrow{\simeq} \mathbf{H}(X \times U, A).$$

Notably for G a smooth ∞ -group and $A = \mathbf{B}G_{\text{conn}}$ a moduli ∞ -stack of smooth G -principal ∞ -bundles with connection the object

$$[\Sigma_k, \mathbf{B}G_{\text{conn}}] \in \mathbf{H}$$

is the smooth higher moduli stack of G -connection *on* Σ_k . It assigns to a test manifold U the ∞ -groupoid of U -parameterized families of G - ∞ -connections, namely of G - ∞ -connections on $X \times U$. This is the smooth higher stack incarnation of the configuration space of higher G -gauge theory on Σ_k .

Example 5.5.3. In the discussion of anomaly polynomials in heterotic string theory over a 10-dimensional spacetime X one encounters degree-12 differential forms $I_4 \wedge I_8$, where I_i is a degree i polynomial in characteristic forms. Clearly these cannot live on X , as every 12-form on X , given by an element in the hom- ∞ -groupoid

$$\mathbf{H}(X, \Omega^{12}(-)) \xrightarrow[\text{Yoneda}]{\simeq} \Omega^{12}(X)$$

is trivial. Instead, these differential forms are elements in the internal hom $[X, \Omega^{12}(-)]$, which means that for every choice of smooth parameter space U there is a smooth 12-form on $X \times U$, such that this system of forms transforms naturally in U .

Below we discuss how such anomaly forms appear from morphisms of higher moduli stacks

$$\mathbf{c}_{\text{conn}} : \mathbf{B}G_{\text{conn}} \rightarrow \mathbf{B}^{11}U(1)_{\text{conn}}$$

for $\mathbf{B}G_{\text{conn}}$ the higher moduli stack of supergravity field configurations by sending the families of moduli of field configurations on spacetime X to their anomaly form:

$$[X, \mathbf{B}G_{\text{conn}}] \xrightarrow{[X, \mathbf{c}_{\text{conn}}]} [X, \mathbf{B}^{11}U(1)_{\text{conn}}] \xrightarrow{[X, \text{curv}]} [X, \Omega^{12}(-)] .$$

We now discuss how such families of n -cocycles on some X can be integrated over X to yield $(n - \dim(X))$ -cocycles. Recall from 4.4.18:

Proposition 5.5.4. *Let Σ_k be a closed (= compact and without boundary) oriented smooth manifold of dimension k . Then for every $n \geq k$ there is a natural morphism of smooth higher stacks*

$$\exp(2\pi i \int_{\Sigma_k} (-)) : [\Sigma_k, \mathbf{B}^n U(1)_{\text{conn}}] \rightarrow \mathbf{B}^{n-k} U(1)_{\text{conn}}$$

from the moduli n -stack of circle n -bundles with connection on Σ_k to the moduli $(n - k)$ -stack of smooth circle $(n - k)$ -bundles with connection such that

1. for $k = n$ this yields a $U(1)$ -valued gauge invariant smooth function

$$\exp(2\pi i \int_{\Sigma_k} (-)) : [\Sigma_n, \mathbf{B}^n U(1)_{\text{conn}}] \rightarrow U(1) ,$$

which is the n -volume holonomy of a circle n -connection over the “ n -dimensional Wilson volume” Σ_n ;

2. for $k_1, k_2 \in \mathbb{N}$ with $k_1 + k_2 \leq n$ we have

$$\exp(2\pi i \int_{\Sigma_{k_1}} (-)) \circ \exp(2\pi i \int_{\Sigma_{k_2}} (-)) \simeq \exp(2\pi i \int_{\Sigma_{k_1} \times \Sigma_{k_2}} (-)) .$$

Proof. Since $\mathbf{B}^n U(1)_{\text{conn}}$ is fibrant in the projective local model structure $[\text{CartSp}^{\text{op}}, \text{sSet}]_{\text{proj,loc}}$ (since every circle n -bundle with connection on a Cartesian space is trivializable) the mapping stack $[\Sigma_k, \mathbf{B}^n U(1)_{\text{conn}}]$ is presented for any choice of good open cover $\{U_i \rightarrow \Sigma_k\}$ by the simplicial presheaf

$$U \mapsto [\text{CartSp}^{\text{op}}, \text{sSet}](\check{C}(U) \times U, \mathbf{B}^n U(1)_{\text{conn}}) ,$$

where $\check{C}(U)$ is the Čech nerve of the open cover $\{U_i \rightarrow \Sigma_k\}$. Therefore a morphism as claimed is given by natural fiber integration of Deligne hypercohomology along product bundles $\Sigma_k \times U \rightarrow U$ for closed Σ_k . This has been constructed for instance in [GoTe00]. \square

Definition 5.5.5. Let $\mathbf{c}_{\text{conn}} : \mathbf{B}G_{\text{conn}} \rightarrow \mathbf{B}^n U(1)_{\text{conn}}$ be a differential characteristic map. Then for Σ_k a closed smooth manifold of dimension $k \leq n$, we call

$$\exp(2\pi i \int_{\Sigma_k} [\Sigma_k, \mathbf{c}_{\text{conn}}]) : [\Sigma_k, \mathbf{B}G_{\text{conn}}] \xrightarrow{[\Sigma_k, \mathbf{c}_{\text{conn}}]} [\Sigma_k, \mathbf{B}^n U(1)_{\text{conn}}] \xrightarrow{\exp(2\pi i \int_{\Sigma_k} (-))} \mathbf{B}^{n-k} U(1)_{\text{conn}}$$

the *off-shell prequantum* $(n - k)$ -bundle of extended \mathbf{c}_{conn} - ∞ -Chern-Simons theory. For $n = k$ we have a circle 0-bundle

$$\exp(2\pi i \int_{\Sigma_n} [\Sigma_n, \mathbf{c}_{\text{conn}}]) : [\Sigma_n, \mathbf{B}G_{\text{conn}}] \xrightarrow{[\Sigma_n, \mathbf{c}_{\text{conn}}]} [\Sigma_n, \mathbf{B}^n U(1)_{\text{conn}}] \xrightarrow{\exp(2\pi i \int_{\Sigma_n} (-))} U(1) ,$$

which we call the *action functional* of the theory.

This construction subsumes several fundamental aspects of Chern-Simons theory:

1. gauge invariance and smoothness of the (extended) action functionals, remark 5.5.6;
2. inclusion of instanton sectors (nontrivial gauge ∞ -bundles), remark 5.5.7;
3. level quantization, remark 5.5.8;
4. definition on non-bounding manifolds and relation to (higher) topological Yang-Mills on bounding manifolds, remark 5.5.9.

We discuss these in more detail in the following remarks, as indicated.

Remark 5.5.6 (Gauge invariance and smoothness). Since $U(1) \in \mathbf{H}$ is an ordinary manifold (after forgetting the group structure), a 0-stack with no non-trivial morphisms (no gauge transformation), the action functional $\exp(2\pi i \int_{\Sigma_n} [\Sigma_n, \mathbf{c}_{\text{conn}}])$ takes every morphism in the moduli stack of field configurations to the identity. But these morphisms are the *gauge transformations*, and so this says that $\exp(2\pi i \int_{\Sigma_n} [\Sigma_n, \mathbf{c}_{\text{conn}}])$ is *gauge invariant*, as befits a gauge theory action functional. To make this more explicit, notice that

$$\mathbf{H}(\Sigma_n, \mathbf{B}G_{\text{conn}}) \simeq [\Sigma_n, \mathbf{B}G_{\text{conn}}](*)$$

is the evaluation of the moduli stack on the point, hence the ∞ -groupoid of smooth families of field configurations which are trivially parameterized. Moreover

$$H_{\text{conn}}^1(\Sigma_n, G) := \pi_0 \mathbf{H}(\Sigma_n, \mathbf{B}G_{\text{conn}})$$

is the set of gauge equivalent such field configurations. Then the statement that the action functional is both gauge invariant and smooth is the statement that it can be extended from $H_{\text{conn}}^1(\Sigma_n, G)$ (supposing that it were given there as a function $\exp(iS(-))$ by other means) via $\mathbf{H}(\Sigma_n, \mathbf{B}G_{\text{conn}})$ to $[\Sigma_n, \mathbf{B}G_{\text{conn}}]$

$$\begin{array}{ccc} H_{\text{conn}}^1(\Sigma_n, G) & \xrightarrow{\exp(iS(-))} & U(1) \\ \downarrow & \nearrow & \\ \mathbf{H}(\Sigma_n, \mathbf{B}G_{\text{conn}}) & \xrightarrow{\exp(2\pi i \int_{\Sigma_n} [\Sigma_n, \mathbf{c}_{\text{conn}}])} & \\ \downarrow & & \\ [\Sigma_n, \mathbf{B}G_{\text{conn}}] & & \end{array} \quad \begin{array}{l} \text{gauge invariance} \\ \text{smoothness .} \end{array}$$

Remark 5.5.7 (Definition on instanton sectors). Ordinary 3-dimensional Chern-Simons theory is often discussed for the special case only when the gauge group G is connected and simply connected. This yields a drastic simplification compared to the general case; since for every Lie group the second homotopy group $\pi_2(G)$ is trivial, and since the homotopy groups of the classifying space BG are those of G shifted up in degree by one, this implies that BG is 3-connected and hence that every continuous map $\Sigma_3 \rightarrow BG$ out of a 3-manifold is homotopic to the trivial map. This implies that every G -principal bundle over Σ_3 is trivializable. As a result, the moduli stack of G -gauge fields on Σ_3 , which a priori is $[\Sigma_3, \mathbf{B}G_{\text{conn}}]$, becomes in this case equivalent to just the moduli stack of trivial G -bundles with (non-trivial) connection on Σ_3 , which is identified with the groupoid of just \mathfrak{g} -valued 1-forms on Σ_3 , and gauge transformations between these, which is indeed the familiar configurations space for 3-dimensional G -Chern-Simons theory.

One should compare this to the case of 4-dimensional G -gauge theory on a 4-dimensional manifold Σ_4 , such as G -Yang-Mills theory. By the same argument as before, in this case G -principal bundles may be nontrivial, but are classified entirely by the second Chern class (or first Pontrjagin class) $[c_2] \in H^4(\Sigma_4, \pi(G))$. In Yang-Mills theory with $G = SU(n)$, this class is known as the *instanton number* of the gauge field.

The simplest case where non-trivial classes occur already in dimension 3 is the non-simply connected gauge group $G = U(1)$, discussed in section 5.5.5.2 below. Here the moduli stack of fields $[\Sigma_3, \mathbf{B}U(1)_{\text{conn}}]$ contains configurations which are not given by globally defined 1-forms, but by connections on non-trivial circle bundles. By analogy with the case of $SU(n)$ -Yang-Mills theory, we will loosely refer to such field configurations as instanton field configurations, too. In this case it is the first Chern class $[c_1] \in H^2(X, \mathbb{Z})$ that measures the non-triviality of the bundle. If the first Chern-class of a $U(1)$ -gauge field configurations happens to vanish, then the gauge field is again given by just a 1-form $A \in \Omega^1(\Sigma_3)$, the familiar gauge potential of electromagnetism. The value of the 3d Chern-Simons action functional on such a non-instanton configuration is simply the familiar expression

$$\exp(iS(A)) = \exp(2\pi i \int_{\Sigma_3} A \wedge d_{\text{dR}} A),$$

where on the right we have the ordinary integration of the 3-form $A \wedge dA$ over Σ_3 .

In the general case, however, when the configuration in $[\Sigma_3, \mathbf{B}U(1)_{\text{conn}}]$ has non-trivial first Chern class, the expression for the value of the action functional on this configuration is more complicated. If we pick a good open cover $\{U_i \rightarrow \Sigma_3\}$, then we can arrange that locally on each patch U_i the gauge field is given by a 1-form A_i and the contribution of the action functional over U_i by $\exp(2\pi i \int_{\Sigma_3} A_i \wedge dA_i)$ as above. But in such a decomposition there are further terms to be included to get the correct action functional. This is what the construction in Prop. 5.5.5 achieves.

Remark 5.5.8 (Level quantization). Traditionally, Chern-Simons theory in 3-dimensions with gauge group a connected and simply connected group G comes in a family parameterized by a *level* $k \in \mathbb{Z}$. This level is secretly the cohomology class of the differential characteristic map

$$\mathbf{c}_{\text{conn}} : \mathbf{B}G_{\text{conn}} \rightarrow \mathbf{B}^3U(1)_{\text{conn}}$$

(constructed in [FSS10]) in

$$H_{\text{smooth}}^3(BG, U(1)) \simeq H^4(BG, \mathbb{Z}) \simeq \mathbb{Z}.$$

So the traditional level is a cohomological shadow of the differential characteristic map that we interpret as the off-shell prequantum n -bundle in full codimension n (down on the point). Notice that for a general smooth ∞ -group G the cohomology group $H^{n+1}(BG, \mathbb{Z})$ need not be equivalent to \mathbb{Z} and so in general the level need not be an integer. For every smooth ∞ -group G , and given a morphism of moduli stacks $\mathbf{c}_{\text{conn}} : \mathbf{B}G_{\text{conn}} \rightarrow \mathbf{B}^nU(1)_{\text{conn}}$, also every integral multiple $k\mathbf{c}_{\text{conn}}$ gives an n -dimensional Chern-Simons theory, “at k -fold level”. The converse is in general hard to establish: whether a given \mathbf{c}_{conn} can be divided by an integer. For instance for 3-dimensional Chern-Simons theory division by 2 may be possible for Spin-structure. For 7-dimensional Chern-Simons theory division by 6 may be possible in the presence of String-structure [FSS12b].

Remark 5.5.9. Ordinary 3-dimensional Chern-Simons theory is often defined on bounding 3-manifolds Σ_3 by

$$\exp(iS(\nabla)) = \exp(2\pi i k \int_{\Sigma_4} \langle F_{\widehat{\nabla}} \wedge F_{\widehat{\nabla}} \rangle),$$

where Σ_4 is any 4-manifold with $\Sigma_3 = \partial\Sigma_4$ and where $\widehat{\nabla}$ is any extension of the gauge field configuration from Σ_3 to Σ_4 . Similar expressions exist for higher dimensional Chern-Simons theories. If one takes these expressions to be the actual definition of Chern-Simons action functional, then one needs extra discussion for which manifolds (with desired structure) are bounding, hence which vanish in the respective cobordism ring, and, more seriously, one needs to include those which are not bounding from the discussion. For example, in type IIB string theory one encounters the cobordism group $\Omega_{11}^{\text{Spin}}(K(\mathbb{Z}, 6))$ [Wi96], which is proven to vanish in [KS05], meaning that all the desired manifolds happen to be bounding.

We emphasize that our formula in Prop. 5.5.5 applies generally, whether or not a manifold is bounding. Moreover, it is guaranteed that *if* Σ_n happens to be bounding after all, then the action functional is equivalently given by integrating a higher curvature invariant over a bounding $(n+1)$ -dimensional manifold. At the level of differential cohomology classes $H_{\text{conn}}^n(-, U(1))$ this is the well-known property (a review and further pointers are given in [HoSi05]) which is an explicit axiom in the equivalent formulation by Cheeger-Simons differential characters: a Cheeger-Simons differential character of degree $(n+1)$ is by definition a group homomorphism from closed n -manifolds to $U(1)$ such that whenever the n -manifold happens to be bounding, the value in $U(1)$ is given by the exponentiated integral of a smooth $(n+1)$ -form over any bounding manifold.

With reference to such differential characters Chern-Simons action functions have been formulated for instance in [Wi96, Wi98c]. The sheaf hypercohomology classes of the Deligne complex that we are concerned with here are well known to be equivalent to these differential characters, and Čech-Deligne cohomology has the advantage that with results such as [GoTe00] invoked in Prop. 5.5.4 above, it yields explicit formulas for the action functional on non-bounding manifolds in terms of local differential form data.

5.5.1.2 Construction from L_∞ -cocycles We discuss the construction of ∞ -Chern-Simons functionals from differential refinements of L_∞ -algebra cocycles.

This section draws from [FiSaScI].

Recall for the following the construction of the ∞ -Chern-Weil homomorphism by Lie integration of Chern-Simons elements, 4.4.17, for L_∞ -algebroids, 4.5.1.

A Chern-Simons element cs witnessing the transgression from an invariant polynomial $\langle - \rangle$ to a cocycle μ is equivalently a commuting diagram of the form

$$\begin{array}{ccc}
 \text{CE}(\mathfrak{a}) & \xleftarrow{\mu} & \text{CE}(b^n \mathbb{R}) & \text{cocycle} \\
 \uparrow & & \uparrow & \\
 \text{W}(\mathfrak{a}) & \xleftarrow{cs} & \text{W}(b^n \mathbb{R}) & \text{Chern-Simons element} \\
 \uparrow & & \uparrow & \\
 \text{inv}(\mathfrak{a}) & \xleftarrow{\langle - \rangle} & \text{inv}(b^n \mathbb{R}) & \text{invariant polynomial}
 \end{array}$$

in $\text{dgAlg}_{\mathbb{R}}$. On the other hand, an n -connection with values in a Lie n -algebroid \mathfrak{a} is a span of simplicial presheaves

$$\begin{array}{ccc}
 \widehat{\Sigma} & \xrightarrow{\nabla} & \mathbf{cosk} \exp(\mathfrak{a})_{\text{conn}} \\
 \downarrow \simeq & & \\
 \Sigma & &
 \end{array}$$

with coefficients in the simplicial presheaf $\mathbf{cosk}_{n+1} \exp(\mathfrak{a})_{conn}$, def. 4.4.126, that sends $U \in \mathbf{CartSp}$ to the $(n + 1)$ -coskeleton, def. 3.6.28, of the simplicial set, which in degree k is the set of commuting diagrams

$$\begin{array}{ccc}
 \Omega_{\text{vert}}^{\bullet}(U \times \Delta^k) \xleftarrow{A_{\text{vert}}} \text{CE}(\mathfrak{a}) & & \text{transition function} \\
 \uparrow & & \uparrow \\
 \Omega^{\bullet}(U \times \Delta^k) \xleftarrow{A} \text{W}(\mathfrak{a}) & & \text{connection forms} \\
 \uparrow & & \uparrow \\
 \Omega^{\bullet}(U) \xleftarrow{\langle F_A \rangle} \text{inv}(\mathfrak{a}) & & \text{curvature characteristic forms}
 \end{array}$$

such that the curvature forms F_A of the ∞ -Lie algebroid valued differential forms A on $U \times \Delta^k$ with values in \mathfrak{a} in the middle are horizontal.

If μ is an ∞ -Lie algebroid cocycle of degree n , then the ∞ -Chern-Weil homomorphism operates by sending an ∞ -connection given by a Čech cocycle with values in simplicial sets of such commuting diagrams to the obvious pasting composite

$$\begin{array}{ccc}
 \Omega_{\text{vert}}^{\bullet}(U \times \Delta^k) \xleftarrow{A_{\text{vert}}} \text{CE}(\mathfrak{a}) \xleftarrow{\mu} \text{CE}(b^n \mathbb{R}) & & : \mu(A_{\text{vert}}) \\
 \uparrow & & \uparrow \\
 \Omega^{\bullet}(U \times \Delta^k) \xleftarrow{A} \text{W}(\mathfrak{a}) \xleftarrow{cs} \text{W}(b^n \mathbb{R}) & & : cs(A) \quad \text{Chern-Simons form} \\
 \uparrow & & \uparrow \\
 \Omega^{\bullet}(U) \xleftarrow{\langle F_A \rangle} \text{inv}(\mathfrak{a}) \xleftarrow{\langle - \rangle} \text{inv}(b^n \mathbb{R}) & & : \langle F_A \rangle \quad \text{curvature}
 \end{array}$$

Under the map to the coskeleton the group of such cocycles for line n -bundle with connection is quotiented by the discrete group Γ of periods of μ , such that the ∞ -Chern-Weil homomorphism is given by sending the ∞ -connection ∇ to

$$\begin{array}{ccc}
 \hat{\Sigma} & \xrightarrow{\nabla} & \mathbf{cosk}_n \exp(\mathfrak{a})_{conn} \xrightarrow{\exp(cs)} \mathbf{B}^n(\mathbb{R}/\Gamma)_{conn} \\
 \downarrow \simeq & & \\
 \Sigma & &
 \end{array}$$

This presents a circle n -bundle with connection, 4.4.16, whose connection n -form is locally given by the Chern-Simons form $cs(A)$. This is the Lagrangian of the ∞ -Chern-Simons theory defined by $(\mathfrak{a}, \langle - \rangle)$ and evaluated on the given ∞ -connection. If Σ is a smooth manifold of dimension n , then the higher holonomy, 4.4.19, of this circle n -bundle over Σ is the value of the Chern-Simons action. After a suitable gauge transformation this is given by the integral

$$\exp(iS(A)) = \exp\left(i \int_{\Sigma} cs(A)\right),$$

the value of the ∞ -Chern-Simons action functional on the ∞ -connection A .

Proposition 5.5.10. *Let \mathfrak{g} be an L_{∞} -algebra and $\langle -, \dots, - \rangle$ an invariant polynomial on \mathfrak{g} . Then the ∞ -connections A with values in \mathfrak{g} that satisfy the equations of motion of the corresponding ∞ -Chern-Simons theory are precisely those for which*

$$\langle -, F_A \wedge F_A \wedge \dots \wedge F_A \rangle = 0,$$

as a morphism $\mathfrak{g} \rightarrow \Omega^{\bullet}(\Sigma)$, where F_A denotes the (in general inhomogeneous) curvature form of A .

In particular for binary and non-degenerate invariant polynomials the equations of motion are

$$F_A = 0.$$

Proof. Let $A \in \Omega(\Sigma \times I, \mathfrak{g})$ be a 1-parameter variation of $A(t=0)$, that vanishes on the boundary $\partial\Sigma$. Here we write $t : [0, 1] \rightarrow \mathbb{R}$ for the canonical coordinate on the interval.

$A(0)$ is critical if

$$\left(\frac{d}{dt} \int_{\Sigma} \text{cs}(A) \right)_{t=0} = 0$$

for all extensions A of $A(0)$. Using Cartan's magic formula and the Stokes theorem the left hand expression is

$$\begin{aligned} \left(\frac{d}{dt} \int_{\Sigma} \text{cs}(A) \right)_{t=0} &= \left(\int_{\Sigma} \frac{d}{dt} \text{cs}(A) \right)_{t=0} \\ &= \left(\int_{\Sigma} d\iota_{\partial_t} \text{cs}(A) + \int_{\Sigma} \iota_{\partial_t} d\text{cs}(A) \right)_{t=0} \\ &= \left(\int_{\Sigma} d_{\Sigma}(\iota_{\partial_t} \text{cs}(A)) + \int_{\Sigma} \iota_{\partial_t} \langle F_A \wedge \cdots F_A \rangle \right)_{t=0} . \\ &= \left(\int_{\partial\Sigma} \iota_{\partial_t} \text{cs}(A) + n \int_{\Sigma} \langle \left(\frac{d}{dt} A \right) \wedge \cdots F_A \rangle \right)_{t=0} \\ &= \left(n \int_{\Sigma} \langle \left(\frac{d}{dt} A \right) \wedge \cdots F_A \rangle \right)_{t=0} \end{aligned}$$

Here we used that $\iota_{\partial_t} F_A = \frac{d}{dt} A$ and that by assumption this vanishes on $\partial\Sigma$. Since $\frac{d}{dt} A$ can have arbitrary values, the claim follows. \square

5.5.2 Higher cup-product Chern-Simons theories

We discuss a class of ∞ -Chern-Simons functionals induced from a smooth differential refinement of the *cup-product* on integral cohomology.

This section draws from [FSS12c].

5.5.2.1 General construction A crucial property of the Dold-Kan map, as discussed in 2.2.6, is the following.

Proposition 5.5.11. *Let A, B and C be presheaves of chain complexes concentrated in non-negative degrees, and let $\cup : A \otimes B \rightarrow C$ be a morphism of presheaves of chain complexes. Then the Dold-Kan map induces a natural morphism of simplicial presheaves $\cup_{\text{DK}} : \text{DK}(A) \times \text{DK}(B) \rightarrow \text{DK}(C)$*

Proof. Both the categories Ch_{\bullet}^+ and sAb are monoidal categories under the respective standard tensor products (on Ch_{\bullet}^+ this is given by direct sums of tensor products of abelian groups with fixed total degree and on sAb by the degreewise tensor product of abelian groups), and the functor Γ is lax monoidal with respect to these structures, i.e., for any $V, W \in \text{Ch}_{\bullet}^+$ we have natural weak equivalences

$$\nabla_{V,W} : \Gamma(V) \otimes \Gamma(W) \rightarrow \Gamma(V \otimes W) .$$

These are not isomorphisms, as they would be for a *strong* monoidal functor, but they are weak equivalences. The forgetful functor F is the right adjoint to the functor forming degreewise the free abelian group on a set, therefore it preserves products and hence there are natural isomorphisms

$$F(V \times W) \xrightarrow{\cong} F(V) \times F(W) ,$$

for all $V, W \in \text{sAb}$. Finally, by the definition of tensor product, there are universal natural quotient maps $V, W \in \text{sAb}$

$$p_{V,W} : V \times W \rightarrow V \otimes W .$$

The morphism \cup_{DK} is then defined as the composition indicated in the following diagram:

$$\begin{array}{ccccc}
\text{DK}(A) \times \text{DK}(B) & \xrightarrow{\quad \cup_{\text{DK}} \quad} & & & \text{DK}(C) \\
\parallel & & & & \parallel \\
F(\Gamma(A)) \times F(\Gamma(B)) & & & & \\
\downarrow \simeq & & & & \\
F(\Gamma(A) \times \Gamma(B)) & \xrightarrow{F(p)} & F(\Gamma(A) \otimes \Gamma(B)) & \xrightarrow{F(\nabla)} & F(\Gamma(A \otimes B)) & \xrightarrow{F(\Gamma(\cup))} & F(\Gamma(C)) .
\end{array}$$

Given the presentation $\mathbf{H} \simeq L_W[\mathcal{C}^{\text{op}}, \text{sSet}]$, for every presheaf of chain complexes A on \mathcal{C} we obtain a corresponding ∞ -stack, the ∞ -stackification of the image of A under the Dold-Kan map, which we will denote by the same symbol: $\text{DK}(A) \in \mathbf{H}$.

Definition 5.5.12. For $A \in [\mathcal{C}^{\text{op}}, \text{Ab}]$ a sheaf of abelian groups, we write $A[n] \in [\mathcal{C}^{\text{op}}, \text{Ch}_{\bullet}^+]$ for the corresponding presheaf of chain complexes concentrated on A in degree n , and

$$\mathbf{B}^n A \simeq \text{DK}(A[n]) \in \mathbf{H}$$

for the corresponding ∞ -stack.

In this case the corresponding cohomology

$$H^n(X, A) = \pi_0 \mathbf{H}(X, \mathbf{B}^n A)$$

is the traditional *sheaf cohomology* of X with coefficients in A . More generally, if $A \in [\mathcal{C}^{\text{op}}, \text{Ch}_{\bullet}^+]$ is a sheaf of chain complexes not necessarily concentrated in one degree, then

$$H^0(X, A) := \pi_0 \mathbf{H}(X, A)$$

is what traditionally is called the *sheaf hypercohomology* of X with coefficients in A . The central coefficient object in which we are interested here is the sheaf of chain complexes called the *Deligne complex*, to which we now turn.

The *Beilinson-Deligne cup product* is an explicit presentation of the cup product in ordinary differential cohomology for the case that the latter is modeled by the Čech-Deligne cohomology.

Definition 5.5.13. The Beilinson-Deligne cup product is the morphism of sheaves of chain complexes

$$\cup_{\text{BD}} : \mathbb{Z}[p+1]_{\mathcal{D}}^{\infty} \otimes \mathbb{Z}[q+1]_{\mathcal{D}}^{\infty} \longrightarrow \mathbb{Z}[(p+1) + (q+1)]_{\mathcal{D}}^{\infty},$$

given on homogeneous elements α, β as follows:

$$\alpha \cup_{\text{BD}} \beta := \begin{cases} \alpha \wedge \beta = \alpha\beta & \text{if } \deg(\alpha) = p+1 . \\ \alpha \wedge d_{\text{dR}}\beta & \text{if } \deg(\alpha) \leq p \text{ and } \deg(\beta) = 0 . \\ 0 & \text{otherwise .} \end{cases}$$

Remark 5.5.14. When restricted to the diagonal in the case that $p = q$, this means that the cup product sends a p -form α to the $(2p+1)$ -form $\alpha \wedge d_{\text{dR}}\alpha$. This is of course the local Lagrangian for cup product Chern-Simons theory of p -forms. We discuss this case in detail in section 5.5.8.1.

The Beilinson-Deligne cup product is associative and commutative up to homotopy, so it induces an associative and commutative cup product on ordinary differential cohomology. A survey of this can be found in [Bry00] (around Prop. 1.5.8 there).

Definition 5.5.15. For $p, q \in \mathbb{N}$ the morphism of simplicial presheaves

$$\cup_{\text{conn}} : \mathbf{B}^p U(1)_{\text{conn}} \times \mathbf{B}^q U(1)_{\text{conn}} \rightarrow \mathbf{B}^{p+q+1} U(1)_{\text{conn}}$$

is the morphism associated to the Beilinson-Deligne cup product $\cup_{\text{BD}} : \mathbb{Z}[p+1]_{\mathcal{D}}^{\infty} \otimes \mathbb{Z}[q+1]_{\mathcal{D}}^{\infty} \rightarrow \mathbb{Z}[p+q+2]_{\mathcal{D}}^{\infty}$ by Proposition 5.5.11.

Since the Beilinson-Deligne cup product is associative up to homotopy, this induces a well defined morphism

$$\mathbf{B}^{n_1} U(1)_{\text{conn}} \times \mathbf{B}^{n_2} U(1)_{\text{conn}} \times \cdots \times \mathbf{B}^{n_{k+1}} U(1)_{\text{conn}} \rightarrow \mathbf{B}^{n_1 + \cdots + n_{k+1} + k} U(1)_{\text{conn}}.$$

In particular, if $n_1 = \cdots = n_{k+1} = 3$, we find

$$(\mathbf{B}^3 U(1)_{\text{conn}})^{k+1} \rightarrow \mathbf{B}^{4k+3} U(1)_{\text{conn}}.$$

Furthermore, we see from the explicit expression of the Beilinson-Deligne cup product that, on a local chart U , if the 3-form datum of a connection on a $U(1)$ -3-bundle is the 3-form C , then the $4k+3$ -form local datum for the corresponding connection on the associated $U(1)$ - $(4k+3)$ -bundle is

$$C \wedge \underbrace{dC \wedge \cdots \wedge dC}_{k \text{ times}}. \quad (5.24)$$

5.5.3 Higher differential Dixmier-Douady class and higher dimensional $U(1)$ -holonomy

The *degenerate* or rather *tautological* case of extended ∞ -Chern-Simons theories nevertheless deserves special attention, since it appears universally in all other examples: that where the extended action functional is the *identity* morphism

$$(\mathbf{DD}_n)_{\text{conn}} : \mathbf{B}^n U(1)_{\text{conn}} \xrightarrow{\text{id}} \mathbf{B}^n U(1)_{\text{conn}} ,$$

for some $n \in \mathbb{N}$. Trivial as this may seem, this is the differential refinement of what is called the (higher) *universal Dixmier-Douady class* the higher universal first Chern class – of circle n -bundles / bundle $(n-1)$ -gerbes, which on the topological classifying space $B^n U(1)$ is the weak homotopy equivalence

$$\text{DD}_n : B^n U(1) \xrightarrow{\simeq} K(\mathbb{Z}, n+1) .$$

Therefore, we are entitled to consider $(\mathbf{DD}_n)_{\text{conn}}$ as the extended action functional of an n -dimensional ∞ -Chern-Simons theory. Over an n -dimensional manifold Σ_n the moduli n -stack of field configurations is that of circle n -bundles with connection on Σ_n . In generalization to how a circle 1-bundle with connection has a *holonomy* over closed 1-dimensional manifolds, we note that a circle n -connection has a *n -volume holonomy* over the n -dimensional manifold Σ_n . This is the ordinary (codimension-0) action functional associated to $(\mathbf{DD}_n)_{\text{conn}}$ regarded as an extended action functional:

$$\text{hol} := \exp(2\pi i \int_{\Sigma_n} [\Sigma_n, (\mathbf{DD}_n)_{\text{conn}}]) : [\Sigma_n, \mathbf{B}^n U(1)_{\text{conn}}] \rightarrow U(1) .$$

This formulation makes it manifest that, for G any smooth ∞ -group and $\mathbf{c}_{\text{conn}} : \mathbf{B}G_{\text{conn}} \rightarrow \mathbf{B}^n U(1)_{\text{conn}}$ any extended ∞ -Chern-Simons action functional in codimension n , the induced action functional is indeed the n -volume holonomy of a family of “Chern-Simons circle n -connections”, in that we have

$$\exp(2\pi i \int_{\Sigma_n} [\Sigma_n, \mathbf{c}_{\text{conn}}]) \simeq \text{hol}_{\mathbf{c}_{\text{conn}}} .$$

This is most familiar in the case where the moduli ∞ -stack $\mathbf{B}G_{\text{conn}}$ is replaced with an ordinary smooth oriented manifold X (of any dimension and not necessarily compact). In this case $\mathbf{c}_{\text{conn}} : X \rightarrow \mathbf{B}^n U(1)_{\text{conn}}$ modulates a circle n -bundle with connection ∇ on this smooth manifold. Now regarding this as an extended Chern-Simons action function in codimension n means to

1. take the moduli stack of fields over a given closed oriented manifold Σ_n to be $[\Sigma_n, X]$, which is simply the space of maps between these manifolds, equipped with its natural (“diffeological”) smooth structure (for instance the smooth loop space LX when $n = 1$ and $\Sigma_n = S^1$);
2. take the value of the action functional on a field configuration $\phi : \Sigma_n \rightarrow X$ to be the n -volume holonomy of ∇

$$\text{hol}_{\nabla}(\phi) = \exp(2\pi i \int_{\Sigma_n} [\Sigma_n, \mathbf{c}_{\text{conn}}]) : [\Sigma_n, X] \xrightarrow{[\Sigma_n, \mathbf{c}_{\text{conn}}]} [\Sigma_n, \mathbf{B}^n U(1)_{\text{conn}}] \xrightarrow{\exp(2\pi \int_{\Sigma_n} (-))} U(1) .$$

Using the proof of Prop. 5.5.4 to unwind this in terms of local differential form data, this reproduces the familiar formulas for (higher) $U(1)$ -holonomy.

5.5.4 1d Chern-Simons functionals

We discuss examples of the intrinsic notion of ∞ -Chern-Simons action functionals, 4.4.19, over 1-dimensional base spaces.

Example 5.5.16. For some $n \in \mathbb{N}$ let

$$\text{tr} : \mathfrak{u}(n) \rightarrow \mathfrak{u}(1) \simeq \mathbb{R}$$

be the trace function, with respect to the canonical identification of $\mathfrak{u}(n)$ with the Lie algebra of skew-Hermitian complex matrices.

This is both a 1-cocycle as well as an invariant polynomial on $\mathfrak{u}(n)$, the former corresponding to a degree-1 element in the Chevalley-Eilenberg algebra $\text{CE}(\mathfrak{u}(n))$ and the latter corresponding to an element $d_W c \in \text{W}(\mathfrak{u}(n))$ of degree 2 in the Weil algebra. Hence c is also the corresponding Chern-Simons element, def. 4.4.119. By prop. 5.2.62 this controls the universal differential first Chern class.

The corresponding Chern-Simons action functional is defined on the groupoid of $\mathfrak{u}(n)$ -valued differential 1-forms on a line segment Σ and given by

$$A \mapsto \int_{\Sigma} \text{tr}(A) .$$

Any choice of coordinates $\Sigma \hookrightarrow \mathbb{R}$ canonically identifies $A \in \Omega^1(\Sigma, \mathfrak{u}(n))$ with a $\mathfrak{u}(n)$ -valued function ϕ . We may think of $\bar{\phi} := \int_{\Sigma} A = \int_{\Sigma} \phi dt$ as the average of this function. In terms of this the action functional is simply the trace function itself

$$\bar{\phi} \mapsto \text{tr}(\bar{\phi}) .$$

Degenerate as this case is, it is sometimes useful to regard the trace as an example of 1-dimensional Chern-Simons theory, for instance in the context of large- N compactified gauge theory as discussed in [Na06].

Example 5.5.17. Below in 5.5.11 we discuss in detail how (derived) L_{∞} -algebroids equipped with non-degenerate binary invariant polynomials of *grade* 0 (hence total degree 2) give rise to 1-dimensional Chern-Simons theories.

5.5.5 3d Chern-Simons functionals

We discuss examples of the intrinsic notion of ∞ -Chern-Simons action functionals, 4.4.19, over 3-dimensional base spaces. This includes the archetypical example of ordinary 3-dimensional Chern-Simons theory, but also its discrete analog, Dijkgraaf-Witten theory.

- 5.5.5.1 – Ordinary Chern-Simons theory;
- 5.5.5.3 – Ordinary Dijkgraaf-Witten theory.

5.5.5.1 Ordinary Chern-Simons theory for simply connected simple gauge group We discuss the action functional of ordinary 3-dimensional Chern-Simons theory (see [Fr95] for a survey) from the point of view of intrinsic Chern-Simons action functionals in $\text{Smooth}\infty\text{Grpd}$.

5.5.5.1.1 Extended Lagrangian and action functional

Theorem 5.5.18. *Let G be a simply connected compact simple Lie group. For*

$$[c] \in H^4(BG, \mathbb{Z}) \simeq \mathbb{Z}$$

a universal characteristic class that generates the degree-4 integral cohomology of the classifying space BG , there is an essentially unique smooth lift \mathbf{c} of the characteristic map c of the form

$$\mathbf{c} : \mathbf{B}G \rightarrow \mathbf{B}^3U(1) \in \text{Smooth}\infty\text{Grpd}$$

on the smooth moduli stack $\mathbf{B}G$ of smooth G -principal bundles with values in the smooth moduli 3-stack of smooth circle 3-bundles. The differential refinement

$$\mathbf{L} : \mathbf{B}G_{\text{conn}} \rightarrow \mathbf{B}^3U(1)_{\text{conn}} \in \text{Smooth}\infty\text{Grpd}$$

to the moduli stacks of the corresponding n -bundles with n -connections induces over any any closed oriented 3-dimensional smooth manifold Σ a smooth functional

$$\exp(iS_{\text{CS}}(-)) := \exp(2\pi i \int_{\Sigma} [\Sigma, \mathbf{L}]) : [\Sigma, \mathbf{B}G_{\text{conn}}] \xrightarrow{\hat{\mathbf{c}}} [\Sigma, \mathbf{B}^3U(1)_{\text{conn}}] \xrightarrow{\exp(2\pi i \int_{\Sigma} (-))} U(1)$$

on the moduli stack of G -principal connections on Σ , which on objects $A \in \Omega^1(\Sigma, \mathfrak{g})$ is the exponentiated Chern-Simons action functional

$$\exp(iS_{\text{CS}}(A)) = \exp(i \int_{\Sigma} \langle A \wedge d_{\text{dR}}A \rangle + \frac{1}{6} \langle A \wedge [A \wedge A] \rangle).$$

Proof. This is theorem 5.1.9 combined with 4.4.134. □

For more computational details that go into this see also 5.5.11.3 below

5.5.5.1.2 The extended phase spaces Let G be a connected and simply connected Lie group. We discuss the nature of the moduli of G -principal connections $G\mathbf{Conn}(\Sigma)$ according to 4.4.16.3 for various choices of Σ .

Proposition 5.5.19. *There is an equivalence*

$$\text{hol} : G\mathbf{Conn}(S^1) \xrightarrow{\simeq} G//_{\text{Ad}}G$$

in $\text{Smooth}\infty\text{Grpd}$ between the moduli stack of G -principal connections on the circle, def. 4.4.97, and the quotient groupoid of the adjoint action of G on itself. This is given by sending G -principal connections to their holonomy (for any chosen basepoint on the circle).

Proof. We show that for each $U \in \text{CartSp}$ the morphism of groupoids hol_U is an equivalence of groupoids.

For $f : U \rightarrow G$ a smooth function, since G is connected and U is topologically contractible, we may find a smooth homotopy

$$\eta : [0, 1] \times U \rightarrow G$$

with $\eta(0)$ constant on the neutral element in a neighbourhood of $\{0\} \times U$ and with $\eta(1) = f$ in a neighbourhood of $\{1\} \times U$. Let then $\eta \mathbf{d}_{[0,1]} \eta^{-1} \in \Omega^1(U \times S^1, \mathfrak{g})$. This is a connection 1-form on $U \times S^1$ whose holonomy is f . Hence hol_U is essentially surjective.

Next, consider $A, A' \in \Omega^1(U \times S^1, \mathfrak{g})$ two connection 1-forms (legs along S^1). Observe that for each point $u \in U$ a gauge transformation $g_u : A_u \rightarrow A'_u$ is fixed already by its value at the basepoint of S^1 and moreover it has to satisfy

$$\text{hol}(A_u) = g_u \text{hol}(A'_u) g_u^{-1}.$$

This is because for every $t \in [0, 1]$ the gauge transformation needs to satisfy the parallel transport naturality condition

$$\begin{array}{ccc} * & \xrightarrow{g_u(t)} & * \\ \text{tra}_{A_u}(0,t) \uparrow & & \uparrow \text{tra}_{A'_u}(0,t) \\ * & \xrightarrow{g_u(0)} & * \end{array} \in *//G,$$

where $\text{tra}_{A_u}(0, t)$ is the parallel transport of the connection A_u along $[0, t]$.

This says that hol_U is also full and faithful. Hence it is an equivalence. □

Remark 5.5.20. We have a dashed lift in

$$\begin{array}{ccc} & [S^1, \mathbf{B}G_{\text{conn}}] & \\ & \nearrow & \downarrow \text{conc} \\ & G\text{Conn}(S^1) & \\ & \simeq \downarrow \text{hol} & \\ G & \longrightarrow & G//_{\text{Ad}}G \end{array},$$

where the top right morphism is the canonical projection of remark 3.9.51, and where the bottom horizontal morphism is the canonical projection map.

Proposition 5.5.21. *There is an equivalence*

$$G\text{Conn}(*) \simeq \mathbf{B}G.$$

5.5.5.2 Ordinary 3d $U(1)$ -Chern-Simons theory and generalized B_n -geometry Ordinary 3-dimensional $U(1)$ -Chern-Simons theory on a closed oriented manifold Σ_3 contains field configurations which are given by globally defined 1-forms $A \in \Omega^1(\Sigma_3)$ and on which the action functional is given by the familiar expression

$$\exp(iS(A)) = \exp(2\pi i k \int_{\Sigma_3} A \wedge d_{\text{dR}} A).$$

More generally, though, a field configuration of the theory is a connection ∇ on a $U(1)$ -principal bundle $P \rightarrow \Sigma_3$ and this simple formula is modified, from being the exponential of the ordinary integral of the wedge product of two differential forms, to the fiber integration in differential cohomology, Def. 5.5.4, of the differential cup-product, Def. 5.5.15:

$$\exp(iS(\nabla)) = \exp(2\pi i k \int_{\Sigma_3} \nabla \cup_{\text{conn}} \nabla).$$

This defines the action functional on the set $H^1_{\text{conn}}(\Sigma_3, U(1))$ of equivalence classes of $U(1)$ -principal bundles with connection

$$\exp(iS(-)) : H^1_{\text{conn}}(\Sigma_3) \rightarrow U(1).$$

That the action functional is gauge invariant means that it extends from a function on gauge equivalence classes to a functor on the groupoid $\mathbf{H}_{\text{conn}}^1(\Sigma_3, U(1))$, whose objects are actual $U(1)$ -principal connections, and whose morphisms are smooth gauge transformations between these:

$$\exp(iS(-)) : \mathbf{H}_{\text{conn}}^1(\Sigma_3) \rightarrow U(1).$$

Finally, that the action functional depends *smoothly* on the connections means that it extends further to the moduli stack of fields to a morphism of stacks

$$\exp(iS(-)) : [\Sigma_3, \mathbf{BU}(1)_{\text{conn}}] \rightarrow U(1).$$

The fully extended prequantum circle 3-bundle of this extended 3d Chern-Simons theory is that of the two-species theory restricted along the diagonal $\Delta : \mathbf{BU}(1)_{\text{conn}} \rightarrow \mathbf{BU}(1)_{\text{conn}} \times \mathbf{BU}(1)_{\text{conn}}$. This is the homotopy fiber of the smooth cup square in these degrees.

According to [Hi12] aspects of the differential geometry of the homotopy fiber of a differential refinement of this cup square are captured by the “generalized geometry of B_n -type” that was suggested in section 2.4 of [Ba11]. In view of the relation of the same structure to differential T-duality discussed above one is led to expect that “generalized geometry of B_n -type” captures aspects of the differential cohomology on fiber products of torus bundles that exhibit auto T-duality on differential K-theory. Indeed, such a relation is pointed out in [Bo11]¹⁷.

5.5.5.3 Ordinary Dijkgraaf-Witten theory Dijkgraaf-Witten theory (see [FrQu93] for a survey) is commonly understood as the analog of Chern-Simons theory for discrete structure groups. We show that this becomes a precise and systematic statement in $\text{Smooth}\infty\text{Grpd}$: the Dijkgraaf-Witten action functional is that induced from applying the ∞ -Chern-Simons homomorphism to a characteristic class of the form $\text{Disc}BG \rightarrow \mathbf{B}^3U(1)$, for $\text{Disc} : \infty\text{Grpd} \rightarrow \text{Smooth}\infty\text{Grpd}$ the canonical embedding of discrete ∞ -groupoids, 4.2, into all smooth ∞ -groupoids.

Let $G \in \text{Grp} \rightarrow \infty\text{Grpd} \xrightarrow{\text{Disc}} \text{Smooth}\infty\text{Grpd}$ be a discrete group regarded as an ∞ -group object in discrete ∞ -groupoids and hence as a smooth ∞ -groupoid with discrete smooth cohesion. Write $BG = K(G, 1) \in \infty\text{Grpd}$ for its delooping in ∞Grpd and $\mathbf{B}G = \text{Disc}BG$ for its delooping in $\text{Smooth}\infty\text{Grpd}$.

We also write $\Gamma\mathbf{B}^nU(1) \simeq K(U(1), n)$. Notice that this is different from $B^nU(1) \simeq \mathbf{I}BU(1)$, reflecting the fact that $U(1)$ has non-discrete smooth structure.

Proposition 5.5.22. *For G a discrete group, morphisms $\mathbf{B}G \rightarrow \mathbf{B}^nU(1)$ correspond precisely to cocycles in the ordinary group cohomology of G with coefficients in the discrete group underlying the circle group*

$$\pi_0\text{Smooth}\infty\text{Grpd}(\mathbf{B}G, \mathbf{B}^nU(1)) \simeq H_{\text{Grp}}^n(G, U(1)).$$

Proof. By the $(\text{Disc} \dashv \Gamma)$ -adjunction we have

$$\text{Smooth}\infty\text{Grpd}(\mathbf{B}G, \mathbf{B}^nU(1)) \simeq \infty\text{Grpd}(BG, K(U(1), n)).$$

□

Proposition 5.5.23. *For G discrete*

- *the intrinsic de Rham cohomology of $\mathbf{B}G$ is trivial*

$$\text{Smooth}\infty\text{Grpd}(\mathbf{B}G, \mathfrak{b}_{\text{dR}}\mathbf{B}^nU((1)) \simeq *;$$

¹⁷ Thanks, once more, to Alexander Kahle, for discussion of this point, at *String-Math 2012*.

- all G -principal bundles have a unique flat connection

$$\text{Smooth}\infty\text{Grpd}(X, \mathbf{B}G) \simeq \text{Smooth}\infty\text{Grpd}(\Pi(X), \mathbf{B}G).$$

Proof. By the $(\text{Disc} \dashv \Gamma)$ -adjunction and using that $\Gamma \circ \mathfrak{b}_{\text{dR}} K \simeq *$ for all K . □
It follows that for G discrete

- any characteristic class $\mathbf{c} : \mathbf{B}G \rightarrow \mathbf{B}^n U(1)$ is a group cocycle;
- the ∞ -Chern-Weil homomorphism coincides with postcomposition with this class

$$\mathbf{H}(\Sigma, \mathbf{B}G) \rightarrow \mathbf{H}(\Sigma, \mathbf{B}^n U(1)).$$

Proposition 5.5.24. *For G discrete and $\mathbf{c} : \mathbf{B}G \rightarrow \mathbf{B}^3 U(1)$ any group 3-cocycle, the ∞ -Chern-Simons theory action functional on a 3-dimensional manifold Σ*

$$\text{Smooth}\infty\text{Grpd}(\Sigma, \mathbf{B}G) \rightarrow U(1)$$

is the action functional of Dijkgraaf-Witten theory.

Proof. By proposition 4.4.134 the morphism is given by evaluation of the pullback of the cocycle $\alpha : BG \rightarrow B^3 U(1)$ along a given $\nabla : \Pi(\Sigma) \rightarrow BG$, on the fundamental homology class of Σ . This is the definition of the Dijkgraaf-Witten action (for instance equation (1.2) in [FrQu93]). □

5.5.6 4d Chern-Simons functionals

We discuss some 4-dimensional Chern-Simons functionals

- 5.5.6.1 – 4d BF theory and topological Yang-Mills;
- 5.5.6.2 – 4d Yetter model.

5.5.6.1 BF theory and topological Yang-Mills theory We discuss how the action functional of nonabelian *BF-theory* [Hor89] in 4-dimensions with a “cosmological constant” and coupled to topological Yang-Mills theory is a higher Chern-Simons theory.

Let $\mathfrak{g} = (\mathfrak{g}_2 \xrightarrow{\partial} \mathfrak{g}_1)$ be a strict Lie 2-algebra, coming from a differential crossed module, def. 1.2.75, as indicated. Let $\exp(\mathfrak{g})$ be the universal Lie integration, according to def. 4.4.56. Field configurations with values in $\exp(\mathfrak{g})$ are locally Lie 2-algebra valued forms ($A \in \Omega^1(\Sigma, \mathfrak{g}_0)$) and $B \in \Omega^2(\Sigma, \mathfrak{g}_1)$ as in prop. 1.2.115.

The following observation is due to [SSS09a].

Proposition 5.5.25. *We have*

1. every invariant polynomial $\langle - \rangle_{\mathfrak{g}_1} \in \text{inv}(\mathfrak{g}_1)$ on \mathfrak{g}_1 gives rise, under the canonical inclusion $\text{inv}(\mathfrak{g}_1) \hookrightarrow W(\mathfrak{g})$, not to an invariant polynomial, but to a Chern-Simons element on \mathfrak{g} , exhibiting the transgression to a trivial L_∞ -algebra cocycle;
2. for \mathfrak{g}_1 a semisimple Lie algebra and $\langle - \rangle_{\mathfrak{g}_1}$ the Killing form, Σ a 4-dimensional compact manifold, the corresponding Chern-Simons action functional

$$\exp(iS_{\langle - \rangle_{\mathfrak{g}_1}}) : [\Sigma, \exp(\mathfrak{g})_{\text{conn}}] \rightarrow \mathbf{B}^4 \mathbb{R}_{\text{conn}}$$

on Lie 2-algebra valued forms is

$$\Omega^\bullet(X) \xleftarrow{\langle (A,B) \rangle} \mathbf{W}(\mathfrak{g}_2 \rightarrow \mathfrak{g}_1) \xleftarrow{\langle \langle - \rangle_{\mathfrak{g}_1}, d_W \langle - \rangle_{\mathfrak{g}_1} \rangle} \mathbf{W}(b^{n-1}\mathbb{R})$$

the sum of the action functionals of topological Yang-Mills theory with BF-theory with cosmological constant:

$$\text{cs}_{\langle - \rangle_{\mathfrak{g}_1}}(A, B) = \langle F_A \wedge F_A \rangle_{\mathfrak{g}_1} - 2\langle F_A \wedge \partial B \rangle_{\mathfrak{g}_1} + 2\langle \partial B \wedge \partial B \rangle_{\mathfrak{g}_1},$$

where F_A is the ordinary curvature 2-form of A .

Proof. For $\{t_a\}$ a basis of \mathfrak{g}_1 and $\{b_i\}$ a basis of \mathfrak{g}_2 we have

$$d_{\mathbf{W}(\mathfrak{g})} : \mathbf{d}t^a \mapsto d_{\mathbf{W}(\mathfrak{g}_1)} + \partial^a_i \mathbf{d}b^i.$$

Therefore with $\langle - \rangle_{\mathfrak{g}_1} = P_{a_1 \dots a_n} \mathbf{d}t^{a_1} \wedge \dots \wedge \mathbf{d}t^{a_n}$ we have

$$d_{\mathbf{W}(\mathfrak{g})} \langle - \rangle_{\mathfrak{g}_1} = n P_{a_1 \dots a_n} \partial^{a_1}_i \mathbf{d}b^i \wedge \dots \wedge \mathbf{d}t^{a_n}.$$

The right hand is a polynomial in the shifted generators of $\mathbf{W}(\mathfrak{g})$, and hence an invariant polynomial on \mathfrak{g} . Therefore $\langle - \rangle_{\mathfrak{g}_1}$ is a Chern-Simons element for it.

Now for $(A, B) \in \Omega^1(U \times \Delta^k, \mathfrak{g})$ an L_∞ -algebra-valued form, we have that the 2-form curvature is

$$F_{(A,B)}^1 = F_A - \partial B.$$

Therefore

$$\begin{aligned} \text{cs}_{\langle - \rangle_{\mathfrak{g}_1}}(A, B) &= \langle F_{(A,B)}^1 \wedge F_{(A,B)}^1 \rangle_{\mathfrak{g}_1} \\ &= \langle F_A \wedge F_A \rangle_{\mathfrak{g}_1} - 2\langle F_A \wedge \partial B \rangle_{\mathfrak{g}_1} + 2\langle \partial B \wedge \partial B \rangle_{\mathfrak{g}_1}. \end{aligned}$$

□

5.5.6.2 4d Yetter model The discussion of 3-dimensional Dijkgraaf-Witten theory as in 5.5.5.3 goes through verbatim for discrete groups generalized to discrete ∞ -groups G , 4.2.2, and cocycles $\alpha : \mathbf{B}G \rightarrow \mathbf{B}^n U(1)$ of any degree n . A field configurations over an n -dimensional manifold Σ is a G -principal ∞ -bundle, 4.2.4, necessarily flat, and the induced action functional

$$\exp(iS_\alpha) : \mathbf{H}(\Sigma, \mathbf{B}G) \rightarrow U(1)$$

sends a G -principal ∞ -bundle classified by a cocycle $g : \Sigma \rightarrow \mathbf{B}G$ to the canonical pairing of the singular cocycle corresponding to $\alpha(g) : \Sigma \rightarrow \mathbf{B}G \xrightarrow{\alpha} \mathbf{B}^n U(1)$ with the fundamental class of Σ .

For $n = 4$ such action functionals sometimes go by the name ‘‘Yetter model’’ [Mac00][MaPo07], in honor of [Yet93], which however did non consider a nontrivial 4-cocycle.

5.5.7 Abelian gauge coupling of branes

The gauge coupling term in the action of an $(n-1)$ -brane charged under an abelian n -form background gauge field (electromagnetism, B -field, C -field, etc.) is an example of an ∞ -Chern-Simons functional. We spell this out in a moment. Here one typically considers the target space of the $(n-1)$ -brane to be a smooth manifold or at most an orbifold. The formal structure, however, allows to consider target spaces that are arbitrary smooth ∞ -groupoids / smooth ∞ -stacks. When generalized to this class of target spaces, the class of brane gauge coupling functionals in fact coincides with that of *all* ∞ -Chern-Simons functionals. Conversely, every ∞ -Chern-Simons theory in dimension n may be regarded as the field theory of a ‘‘topological $(n-1)$ -brane’’ whose target space is the higher moduli stack of field configurations of the given ∞ -Chern-Simons theory.

For X a smooth manifold, let $c \in H^{n+1}(X, \mathbb{Z})$ be a class in integral cohomology, to be called the higher *background magnetic charge*. A smooth refinement of this class to a morphism

$$\mathbf{c} : X \rightarrow \mathbf{B}^n U(1)$$

is a circle n -bundle on X , whose topological class is c

$$\hat{\mathbf{c}} : X \rightarrow \mathbf{B}^n U(1)_{\text{conn}}$$

A differential refinement of this is a choice of refinement to a circle n -bundle with connection ∇ .

Now let Σ the compact n -dimensional worldvolume of an $(n-1)$ -brane. Then $[\Sigma, X]$ is the diffeological space (def. 4.4.14) of smooth maps $\phi : \Sigma \rightarrow X$. The induced ∞ -Chern-Simons functional

$$\exp(iS_{\hat{\mathbf{c}}}) : [\Sigma, X] \xrightarrow{[\hat{\mathbf{c}}, \Sigma]} [\Sigma, \mathbf{B}^n U(1)_{\text{conn}}] \xrightarrow{f_{\Sigma}} U(1)$$

is the ordinary n -volume holonomy of ∇ over trajectories $\phi : \Sigma \rightarrow X$.

5.5.8 Higher abelian Chern-Simons functionals

We discuss higher Chern-Simons functionals on higher abelian gauge fields, notably on circle n -bundles with connection.

- 5.5.8.1 – $(4k+3)\text{d } U(1)$ -Chern-Simons functionals;
- 5.5.8.2 – Higher electric coupling and higher gauge anomalies.

5.5.8.1 $(4k+3)\text{d } U(1)$ -Chern-Simons functionals We discuss higher dimensional abelian Chern-Simons theories in dimension $4k+3$.

The basic ideas can be found in [HoSi05]. We refine the discussion there from differential cohomology classes to higher moduli stacks of differential cocycles. The case in dimension 3 ($k=0$) is discussed for instance in [GuTh08]. The case in dimension 7 ($k=1$) is the higher Chern-Simons theory whose holographic boundary theory encodes the self-dual 2-form gauge theory on the single 5-brane [Wi97b]. Generally, for every k the $(4k+3)$ -dimensional abelian Chern-Simons theory induces a self-dual higher gauge theory holographically on its boundary, see [BeMo06].

Proposition 5.5.26. *The cup product in integral cohomology*

$$(-) \cup (-) : H^{k+1}(-, \mathbb{Z}) \times H^{l+1}(-, \mathbb{Z}) \rightarrow H^{k+l+2}(-, \mathbb{Z})$$

has a smooth and differential refinement to the moduli ∞ -stacks $\mathbf{B}^n U(1)_{\text{conn}}$, prop. 4.4.91, for circle n -bundles with connection

$$(-) \hat{\cup} (-) : \mathbf{B}^k U(1)_{\text{conn}} \times \mathbf{B}^l U(1)_{\text{conn}} \rightarrow \mathbf{B}^{k+l+1} U(1)_{\text{conn}}.$$

Proof. By the discussion in 4.4.16 we have that $\mathbf{B}^k U(1)_{\text{conn}}$ is presented by the simplicial presheaf

$$\Xi \mathbb{Z}_D^{\infty}[k+1] \in [\text{CartSp}^{\text{op}}, \text{sSet}],$$

which is the image of the Deligne-Beilinson complex, def. 1.2.131, under the Dold-Kan correspondence, prop. 2.2.6. A lift of the cup product to the Deligne complex is given by the *Deligne-Beilinson cup product* [Del71][Bel85]. Since the Dold-Kan functor $\Xi : [\text{CartSp}^{\text{op}}, \text{Ch}_{\bullet}] \rightarrow [\text{CartSp}^{\text{op}}, \text{sSet}]$ is right adjoint, it preserves products and hence this cup product. \square

Definition 5.5.27. Let Σ be a compact manifold of dimension $4k + 3$ for $k \in \mathbb{N}$. Consider the moduli stack $[\Sigma, \mathbf{B}^k U(1)_{\text{conn}}]$ of circle $(2k + 1)$ -bundles with connection on Σ .

On this space, the action functional of higher abelian Chern-Simons theory is defined to be the composite

$$\exp(iS(-)) : [\Sigma, \mathbf{B}^{2k+1}U(1)_{\text{conn}}] \xrightarrow{(-)\hat{\cup}(-)} [\Sigma, \mathbf{B}^{4k+3}U(1)_{\text{conn}}] \xrightarrow{\int_{\Sigma}} U(1) .$$

Observation 5.5.28. When restricted to differential $(2k + 1)$ -forms, regarded as connections on trivial circle $(2k + 1)$ -bundles

$$\Omega^{2k+1}(\Sigma) \hookrightarrow [\Sigma, \mathbf{B}^{2k+1}U(1)_{\text{conn}}]$$

this action functional sends a $(2k + 1)$ -form C to

$$\exp(iS(C)) = \exp\left(i \int_{\Sigma} C \wedge d_{\text{dR}} C\right) .$$

From this expression one sees directly why the corresponding functional is not interesting in the remaining dimensions, because for even degree forms we have $C \wedge dC = \frac{1}{2}d(C \wedge C)$ and hence for these the above functional would be constant.

5.5.8.2 Higher electric coupling and higher gauge anomalies The action functional of ordinary Maxwell electromagnetism in the presence of an electric background current involves a differential cup-product term similar to that in def. 5.5.27. This has a direct generalization to higher electromagnetic fields and the corresponding higher electric currents. If, moreover, a background *magnetic* current is present, then this action functional is, in general, anomalous. The “higher gauge anomalies” in higher dimensional supergravity theories arise this way. This is discussed in [Fr00].

Here we refine this discussion from differential cohomology classes to higher moduli stacks of differential cocycles.

Definition 5.5.29. Let Σ be a compact smooth manifold of dimension d .

By prop. 5.5.26 the universal cup product class

$$(-) \cup (-) : B^n U(1) \times B^{d-n-1} U(1) \rightarrow B^d U(1)$$

for any $0 \leq n \leq d$ has a smooth and differential refinement $\hat{\cup}$. We write

$$\exp(iS_{\hat{\cup}}) : [\Sigma, \mathbf{B}^n U(1)_{\text{conn}} \times \mathbf{B}^{d-n-1} U(1)_{\text{conn}}] \xrightarrow{(-)\hat{\cup}(-)} [\Sigma, \mathbf{B}^d U(1)_{\text{conn}}] \xrightarrow{\int_{\Sigma}} U(1)$$

for the corresponding higher Chern-Simons action functional on the higher moduli stack of *pairs* consisting of an n -connection and an $(d - n - 1)$ -connection on Σ .

Remark 5.5.30. When restricted to pairs of differential forms

$$(B_1, B_2) \in \Omega^n(\Sigma) \times \Omega^{d-n-1}(\Sigma) \hookrightarrow [\Sigma, \mathbf{B}^n U(1)_{\text{conn}} \times \mathbf{B}^{d-n-1} U(1)_{\text{conn}}]$$

this functional sends

$$(B_1, B_2) \mapsto \exp\left(i \int_{\Sigma} B_1 \wedge dB_2\right) .$$

The higher Chern-Simons functional of def. 5.5.8.1 is the *diagonal* of this functional, where $B_1 = B_2$. We now consider another variant, where only B_1 is taken to vary, but B_2 is regarded as fixed.

Let X be an d -dimensional manifold. The configuration space of higher electromagnetic fields of degree n on X is the moduli stack of circle n -bundles with connection $[X, \mathbf{B}^n U(1)_{\text{conn}}]$ on X .

Definition 5.5.31. An *electric background current* on X for degree p electromagnetism is a circle $(d-n-1)$ -bundle with connection $\hat{j}_{\text{el}} : X \rightarrow \mathbf{B}^{d-n-1}U(1)_{\text{conn}}$.

The *electric coupling action functional* of the higher electromagnetic field in the presence of the background electric current is

$$\exp(iS_{\text{el}}) : [X, \mathbf{B}^n U(1)_{\text{conn}}] \xrightarrow{(-) \cup \hat{j}_{\text{el}}} [X, \mathbf{B}^d U(1)_{\text{conn}}] \xrightarrow{f_X} U(1) ,$$

where the first morphism is the differentially refined cup product from prop. 5.5.26.

Remark 5.5.32. For the case of ordinary Maxwell theory, with $n = 1$ and $d = 4$, the electric current is a circle 2-bundle with connection. Its curvature 3-form is traditionally denoted j_{el} . If X is equipped with Lorentzian structure, then its integral over a (compact) spatial slice is the background *electric charge*. Integrality of this value, following from the nature of differential cohomology, is the *Dirac charge quantization* that makes electric charge appear in integral multiples of a fixed unit charge.

For $A \in \Omega^1(X) \rightarrow [X, \mathbf{B}U(1)_{\text{conn}}]$ a globally defined connection 1-form, the above action functional is given by

$$A \mapsto \exp\left(i \int_X A \wedge j_{\text{el}}\right).$$

In the limiting case that the background electric charge is that carried by a charged point particle, j_{el} is the current which is Poincaré-dual to the trajectory $\gamma : S^1 \rightarrow X$ of the particle. In this case the above goes to

$$\dots \rightarrow \exp\left(i \int_{\Sigma} A\right),$$

hence the line holonomy of A along the trajectory of the background charge.

(...)

5.5.9 7d Chern-Simons functionals

We discuss some higher Chern-Simons functionals over 7-dimensional parameter spaces.

- 5.5.9.1 – The cup product of a 3d CS theory with itself;
- 5.5.9.2 – 7d CS theory on string 2-connection fields;
- 5.5.9.3 – 7d CS theory in 11d supergravity on AdS₇.

This section draws from [FSS12b].

5.5.9.1 The cup product of a 3d CS theory with itself Let G be a compact and simply connected simple Lie group and consider from 5.5.5.1 the canonical differential characteristic map for the induced 3d Chern-Simons theory

$$\hat{c} : \mathbf{B}G_{\text{conn}} \rightarrow \mathbf{B}^3U(1)_{\text{conn}} .$$

We consider the differentially refined *cup product*, prop. 5.5.26, of this differential characteristic map with itself.

Observation 5.5.33. The topological degree-8 class

$$c \cup c : BG \xrightarrow{(c,c)} K(\mathbb{Z}, 4) \times K(\mathbb{Z}, 4) \xrightarrow{\cup} K(\mathbb{Z}, 8)$$

has a smooth and differential refinement of the form

$$\hat{c} \hat{\cup} \hat{c} : \mathbf{B}G_{\text{conn}} \xrightarrow{\hat{c}} \mathbf{B}^3U(1)_{\text{conn}} \times \mathbf{B}^3U(1)_{\text{conn}} \xrightarrow{\hat{\cup}} \mathbf{B}^7U(1)_{\text{conn}} .$$

Proof. By the discussion in 5.5.8.1. □

Definition 5.5.34. Let Σ be a compact smooth manifold of dimension 7. The higher Chern-Simons functional

$$\exp(iS_{\text{CS}}(-)) : [\Sigma, \mathbf{B}G_{\text{conn}}] \xrightarrow{\hat{\mathbf{e}}\hat{\cup}\hat{\mathbf{e}}} [\Sigma, \mathbf{B}^7U(1)_{\text{conn}}] \xrightarrow{J_{\Sigma}} U(1)$$

defines the *cup product Chern-Simons theory* induced by \mathbf{c} .

Remark 5.5.35. For ordinary Chern-Simons theory, 5.5.5.1, the assumption that G is simply connected implies that BG is 3-connected, hence that every G -principal bundle on a 3-dimensional Σ is trivializable, so that G -principal connections on Σ can be identified with \mathfrak{g} -valued differential forms on Σ . This is no longer in general the case over a 7-dimensional Σ .

Proposition 5.5.36. *If a field configuration $A \in [\Sigma, \mathbf{B}G_{\text{conn}}]$ happens to have trivial underlying bundle, then the value of the cup product CS theory action functional is given by*

$$\exp(iS_{\text{CS}}(A)) = \int_{\Sigma} \text{CS}(A) \wedge \langle F_A \wedge F_A \rangle,$$

where $\text{CS}(-)$ is the Lagrangian of ordinary Chern-Simons theory, 5.5.5.1.

5.5.9.2 7d CS theory on string 2-connection fields By theorem 5.1.32 we have a canonical differential characteristic map

$$\frac{1}{6}\hat{\mathbf{p}}_2 : \mathbf{B}\text{String}_{\text{conn}} \rightarrow \mathbf{B}^7U(1)_{\text{conn}}$$

from the smooth moduli 2-stack of String-2-connections, 1.2.8.7.2, with values in the smooth moduli 7-stack of circle 7-bundles (bundle 6-gerbes) with connection. This induces a 7-dimensional Chern-Simons theory.

Definition 5.5.37. For Σ a compact 7-dimensional smooth manifold, define $\exp(iS_{\frac{1}{6}\hat{\mathbf{p}}_2}(-))$ to be the Chern-Simons action functional induced by the universal differential second fractional Pontryagin class, theorem 5.1.32,

$$\exp(iS_{\frac{1}{6}\hat{\mathbf{p}}_2}(-)) : [\Sigma, \mathbf{B}\text{String}_{\text{conn}}] \xrightarrow{\frac{1}{6}\hat{\mathbf{p}}_2} [\Sigma, \mathbf{B}^7U(1)_{\text{conn}}] \xrightarrow{J_{\Sigma}} U(1).$$

Recall from 1.2.8.7.2 the different incarnations of the local differential form data for string 2-connections.

Proposition 5.5.38. *Over a 7-dimensional Σ every field configuration $(A, B) \in [\Sigma, \mathbf{B}\text{String}_{\text{conn}}]$ is a string 2-connection whose underlying String-principal 2-bundle is trivial.*

- *In terms of the strict **string** Lie 2-algebra from def. 1.2.182 this is presented by a pair of nonabelian differential forms $A \in \Omega^1(\Sigma, P_*\mathfrak{so})$, $B \in \Omega^2(\Sigma, \hat{\Omega}_*\mathfrak{so})$. The above action functional takes this to*

$$\begin{aligned} \exp(iS_{\frac{1}{6}\hat{\mathbf{p}}_2}(A, B)) &= \int_{\Sigma} \text{CS}_7(A(1)) \\ &= \int_{\Sigma} (\langle A_e \wedge dA_e \wedge dA_e \wedge dA_e \rangle + k_1 \langle A_e \wedge [A_e \wedge A_e] \wedge dA_e \wedge dA_e \rangle \\ &\quad + k_2 \langle A_e \wedge [A_e \wedge A_e] \wedge [A_e \wedge A_e] \wedge dA_e \rangle + k_3 \langle A_e \wedge [A_e \wedge A_e] \wedge [A_e \wedge A_e] \wedge [A_e \wedge A_e] \rangle) \end{aligned}$$

where $A_e \in \Omega^1(\Sigma, \mathfrak{so})$ is the 1-form of endpoint values of A in the path Lie algebra, and where the integrand is the degree-7 Chern-Simons element of the quaternary invariant polynomial on \mathfrak{so} .

- *In terms of the skeletal **string** Lie 2-algebra from def. 1.2.181 this is presented by a pair of differential forms $A \in \Omega^1(\Sigma, \mathfrak{so})$, $B \in \Omega^2(\Sigma, \mathbb{R})$. The above action functional takes this to*

$$\exp(iS_{\frac{1}{6}\hat{\mathbf{p}}_2}(A, B)) = \int_{\Sigma} \text{CS}_7(A).$$

5.5.9.3 7d CS theory in 11d supergravity on AdS₇ The two 7-dimensional Chern-Simons theories from 5.5.9.1 and 5.5.9 can be merged to a 7d theory defined on field configurations that are 2-connections with values in the String-2-group from def. 5.1.43. We define and discuss this higher Chern-Simons theory below in 5.5.9.3.2. In 5.5.9.3.1 we argue that this 7d Chern-Simons theory plays a role in AdS₇/CFT₆-duality [AGMOO].

5.5.9.3.1 Motivation from AdS₇/CFT₆-holography We give here an argument that the 7-dimensional nonabelian gauge theory discussed in section 5.5.9.3.2 is the Chern-Simons part of 11-dimensional supergravity on AdS₇ × S⁴ with 4-form flux on the S⁴-factor and with quantum anomaly cancellation conditions taken into account. We moreover argue that this implies that the states of this 7-dimensional CS theory over a 7-dimensional manifold encode the conformal blocks of the 6-dimensional worldvolume theory of coincident M5-branes. The argument is based on the available but incomplete knowledge about AdS/CFT-duality, such as reviewed in [AGMOO], and cohomological effects in M-theory as reviewed and discussed in [Sa10a].

There are two, seemingly different, realizations of the *holographic principle* in quantum field theory. On the one hand, Chern-Simons theories in dimension 4k + 3 have spaces of states that can be identified with spaces of correlators of (4k + 2)-dimensional conformal field theories (spaces of “conformal blocks”) on their boundary. For the case k = 0 this was discussed in [Wi89], for the case k = 1 in [Wi96]. On the other hand, AdS/CFT duality (see [AGMOO] for a review) identifies correlators of d-dimensional CFTs with states of compactifications of string theory, or M-theory, on asymptotically anti-de Sitter spacetimes of dimension d + 1 (see [Wi98a]).

In [Wi98c] it was pointed out that these two mechanisms are in fact closely related. A detailed analysis of the AdS₅/SYM₄-duality shows that the spaces of correlators of the 4-dimensional theory can be identified with the spaces of states obtained by geometric quantization just of the Chern-Simons term in the effective action of type II string theory on AdS₅, which locally reads

$$(B_{\text{NS}}, B_{\text{RR}}) \mapsto N \int_{\text{AdS}_5} B_{\text{NS}} \wedge dB_{\text{RR}} ,$$

where B_{NS} is the local Neveu-Schwarz 2-form field, B_{RR} is the local RR 2-form field, and where N is the RR 5-form flux picked up from integration over the S⁵ factor.

As briefly indicated there, the similar form of the Chern-Simons term of 11-dimensional supergravity (M-theory) on AdS₇ suggests that an analogous argument shows that under AdS₇/CFT₆-duality the conformal blocks of the (2, 0)-superconformal theory are identified with the geometric quantization of a 7-dimensional Chern-Simons theory. In [Wi98c] that Chern-Simons action is taken, locally on AdS₇, to be

$$C_3 \mapsto \int_{\text{AdS}_7 \times S^4} C_3 \wedge G_4 \wedge G_4 = N \int_{\text{AdS}_7} C_3 \wedge dC_3 ,$$

where now C₃ is the local incarnation of the supergravity C-field, 5.2.8.4.2, where G₄ is its curvature 4-form locally equal to dC₃, and where

$$N := \int_{S^4} G_4$$

is the C-field flux on the 4-sphere factor.

This is the (4 · 1 + 3 = 7)-dimensional abelian Chern-Simons theory, 5.5.11.6, shown in [Wi96] to induce on its 6-dimensional boundary the self-dual 2-form – in the *abelian* case.

In order to generalize this to the nonabelian case of interest, we notice that there is a term missing in the above Lagrangian. The quantum anomaly cancellation in 11-dimensional supergravity is known from [DLM95](3.14) to require a corrected Lagrangian whose Chern-Simons term locally reads

$$(\omega, C_3) \mapsto \int_{\text{AdS}_7 \times S^4} C_3 \wedge (G_4 \wedge G_4 - I_8^{\text{dR}}(\omega)) ,$$

where ω is the spin connection form, locally, and where $8I_8^{\text{dR}}(\omega)$ is a de Rham representative of the integral cohomology class

$$8I_8 = \frac{1}{6}p_2 - 8\left(\frac{1}{2}p_1\right) \cup \left(\frac{1}{2}p_1\right), \quad (5.25)$$

with $\frac{1}{2}p_1$ and $\frac{1}{6}p_2$ the first and second fractional Pontrjagin classes, prop. 5.1.5, prop. 5.1.30, respectively, of the given Spin bundle over 11-dimensional spacetime X .

This means that after passing to the effective theory on AdS_7 , this corrected Lagrangian picks up another 7-dimensional Chern-Simons term, now one depending on *nonabelian* fields (with values in Spin and E_8). Locally this reads

$$S_{7\text{dCS}} : (\omega, C_3) \mapsto N \int_{\text{AdS}_7} C_3 \wedge dC_3 - \frac{N}{8} \int_{\text{AdS}_7} \text{CS}_{8I_8}(\omega) \quad . \quad (5.26)$$

where $\text{CS}_{8I_8}(\omega)$ is a Chern-Simons form for $8I_8^{\text{dR}}(\omega)$, defined locally by

$$d\text{CS}_{8I_8}(\omega) = 8I_8^{\text{dR}}(\omega).$$

But this action functional, which is locally a functional of a 3-form and a Spin-connection, cannot globally be of this form, already because the field that looks locally like a Spin connection cannot globally be a Spin connection. To see this, notice from the discussion of the C -field in 5.2.9, that there is a quantization condition on the supergravity fields on the 11-dimensional X [Wi97a], which in cohomology requires the identity

$$2[G_4] = \frac{1}{2}p_1 + 2a \in H^4(X, \mathbb{Z}),$$

where on the right we have the canonical characteristic 4-class a , prop. 5.1.41, of an ‘auxiliary’ E_8 bundle on 11-dimensional spacetime. Moreover, we expect that when restricted to the vicinity of the asymptotic boundary of AdS_7 ,

- the class of G_4 vanishes;
- the E_8 -bundle becomes equipped with a connection, too (the E_8 -field “becomes dynamical”);

in analogy to what happens at the boundary for the Hořava-Witten compactification of the 11-dimensional theory [HoWi95], as discussed in 5.2.9.6. Since, moreover, the states of the topological TFT that we are after are obtained already from geometric quantization, 3.9.13, of the theory in the vicinity $\Sigma \times I$ of a boundary Σ , we find the field configurations of the 7-dimensional theory are to satisfy the constraint in cohomology

$$\frac{1}{2}p_1 + 2a = 0. \quad (5.27)$$

Imposing this condition has two effects.

1. The first is that, according to 3.9.8, what locally looks like a spin-connection is globally instead a *twisted differential String structure*, 5.2.7.3, or equivalently a *2-connection on a twisted String-principal 2-bundle*, where the twist is given by the class $2a$. By 1.2.5.3 the total space of such a principal 2-bundle may be identified with a (twisted) *nonabelian bundle gerbe*. Therefore the configuration space of fields of the effective 7-dimensional nonabelian Chern-Simons action above should not involve just Spin connection forms, but String-*2-connection* form data. By 1.2.8.7.2 there is a gauge in which this is locally given by nonabelian 2-form field data with values in the loop group of Spin.
2. The second effect is that on the space of twisted String-2-connections, the differential 4-form $\text{tr}(F_\omega \wedge F_\omega)$, that under the Chern-Weil homomorphism represents the image of $\frac{1}{2}p_1$ in de Rham cohomology, according to 5.2.7.3.1, locally satisfies

$$dH_3 = \langle F_\omega \wedge F_\omega \rangle - 2\langle F_A \wedge F_A \rangle,$$

where H_3 is the 3-form curvature component of the String-2-connection, and where F_A is the curvature of a connection on the E_8 bundle, locally given by an \mathfrak{e}_8 -valued 1-form A . Therefore with the quantization condition of the C -field taken into account, the 7-dimensional Chern-Simons action (5.26) becomes

$$S_{7dCS} = N \int_{\text{AdS}_7} \left(C_3 \wedge dC_3 - \frac{1}{8} H_3 \wedge dH_3 - \frac{1}{4} (H_3 + 2CS_a(A) \wedge \text{tr}(F_\omega \wedge F_\omega) + \frac{1}{8} CS_{\frac{1}{6}\hat{\mathbf{p}}_2}(\omega) \right). \quad (5.28)$$

Here the first two terms are 7-dimensional abelian Chern-Simons actions as before, for fields that are both locally abelian three forms (but have very different global nature). The second two terms, however, are action functionals for *nonabelian* Chern-Simons theories. The third term involves the familiar Chern-Simons 3-form of the E_8 -connection familiar from 3-dimensional Chern-Simons theory

$$CS_a(A) = \text{tr}(A \wedge dA) + \frac{2}{3} \text{tr}(A \wedge A \wedge A).$$

Finally the fourth term is the Chern-Simons 7-form that is locally induced, under the Chern-Weil homomorphism, from the quartic invariant polynomial $\langle -, -, -, - \rangle : \mathfrak{so}^{\otimes 4} \rightarrow \mathbb{R}$ on the special orthogonal Lie algebra \mathfrak{so} , in direct analogy to how standard 3-dimensional Chern-Simons theory is induced under Chern-Weil theory from the quadratic invariant polynomial (the Killing form) $\langle -, - \rangle : \mathfrak{so} \otimes \mathfrak{so} \rightarrow \mathbb{R}$:

$$\begin{aligned} CS_7(\omega) = & \langle \omega \wedge d\omega \wedge d\omega \wedge d\omega \rangle + k_1 \langle \omega \wedge [\omega \wedge \omega] \wedge d\omega \wedge d\omega \rangle \\ & + k_2 \langle \omega \wedge [\omega \wedge \omega] \wedge [\omega \wedge \omega] \wedge d\omega \rangle + k_3 \langle \omega \wedge [\omega \wedge \omega] \wedge [\omega \wedge \omega] \wedge [\omega \wedge \omega] \rangle. \end{aligned}$$

This line of arguments suggests that the Chern-Simons term that governs 11-dimensional supergravity on $\text{AdS}_7 \times S^4$ is an action functional on fields that are twisted String-2-connections such that the action functional is locally given by (5.28). In 5.5.9.3.2 we show that a Chern-Simons theory satisfying these properties naturally arises from the differential characteristic maps discussed above in 5.5.9.1 and 5.5.9.

5.5.9.3.2 Definition and properties We discuss now a twisted combination of the two 7-dimensional Chern-Simons action functionals from 5.5.9.1 and 5.5.9 which naturally lives on the moduli 2-stack $C\text{Field}(-)^{\text{bdr}}$ of boundary C -field configurations from 5.2.131. We show that on ∞ -connection field configurations whose underlying ∞ -bundles are trivial, this functional reduces to that given in equation (5.28).

It is instructive to first consider the simple special case where the E_8 is trivial. In this case the boundary moduli stack $C\text{Field}^{\text{bdr}}$ from observation 5.2.132 restricts to just that of string 2-connections, $\mathbf{BString}_{\text{conn}}$.

Definition 5.5.39. Write $8\hat{\mathbf{I}}_8$ for the smooth universal differential characteristic cocycle

$$8\hat{\mathbf{I}}_8 : \mathbf{BString}_{\text{conn}} \xrightarrow{(\frac{1}{6}\hat{\mathbf{p}}_2) - 8(\frac{1}{2}\hat{\mathbf{p}}_1 \hat{\cup} \frac{1}{2}\hat{\mathbf{p}}_1)} \mathbf{B}^7U(1)_{\text{conn}},$$

where $\frac{1}{6}\hat{\mathbf{p}}_2$ is the differential second fractional Pontryagin class from theorem 5.1.32 and where $\frac{1}{2}\hat{\mathbf{p}}_1 \hat{\cup} \frac{1}{2}\hat{\mathbf{p}}_1$ is the differential cup product class from observation 5.5.33.

Definition 5.5.40. For Σ a compact smooth manifold of dimension 7, the canonically induced action functional $\exp(iS_{8I_8}(-))$ from def. 3.9.68, on the moduli 2-stack of String-2-connections is the composite

$$\exp(iS_{8I_8}(-)) : [\Sigma, \mathbf{BString}_{\text{conn}}] \xrightarrow{8\hat{\mathbf{I}}_8} [\Sigma, \mathbf{B}^7U(1)_{\text{conn}}] \xrightarrow{\int_\Sigma} U(1).$$

We give now an explicit description of the field configurations in $[\Sigma, \mathbf{BString}_{\text{conn}}]$ and of the value of $\exp(iS_{8I_8}(-))$ on these in terms of differential form data.

Proposition 5.5.41. *A field configuration in $[\Sigma, \mathbf{BString}_{\text{conn}}] \in \text{Smooth}\infty\text{Grpd}$ is presented in the model category $[\text{CartSp}^{\text{op}}, \text{sSet}]_{\text{proj,loc}}$, 4.4, by a correspondence of simplicial presheaves*

$$\begin{array}{c} C(\{U_i\}) \xrightarrow{\phi} \mathbf{cosk}_3 \exp(b\mathbb{R} \rightarrow \mathfrak{so}_\mu)_{\text{cönn}} , \\ \downarrow \simeq \\ \Sigma \end{array}$$

where \mathfrak{so}_μ is the skeletal String Lie 2-algebra, def. 1.2.181, and where on the right we have the adapted differential coefficient object from prop. 5.2.94; such that the projection

$$C(\{U_i\}) \xrightarrow{\phi} \mathbf{cosk}_3 \exp(b\mathbb{R} \rightarrow \mathfrak{so}_\mu)_{\text{cönn}} \longrightarrow \mathbf{B}^3U(1)_{\text{conn}}$$

has a class.

The underlying nonabelian cohomology class of such a cocycle is that of a String-principal 2-bundle. The local connection and curvature differential form data over a patch U_i is

$$\begin{aligned} F_\omega &= d\omega + \frac{1}{2}[\omega \wedge \omega] \\ H_3 &= \nabla B := dB + \text{CS}(\omega) \\ dF_\omega &= -[\omega \wedge F_\omega] \\ dH_3 &= \langle F_\omega \wedge F_\omega \rangle \end{aligned}$$

Proof. Without the constraint on the C -field this is the description of twisted String-2-connections of observation 5.2.96 where the twist is the C -field. The condition above picks out the untwisted case, where the C -field is trivialized. What remains is an untwisted String-principal 2-bundle.

The local differential form data is found from the modified Weil algebra of $(b\mathbb{R} \rightarrow (\mathfrak{so})_{\mu_{s_0}})$ indicated on the right of the following diagram

$$\left(\begin{array}{l} F_\omega = d\omega + \frac{1}{2}[\omega \wedge \omega] \\ H_3 = \nabla B := dB + \text{CS}(\omega) - C_3 \\ \mathcal{G}_4 = dC_3 \\ dF_\omega = -[\omega \wedge F_\omega] \\ dH_3 = \langle F_\omega \wedge F_\omega \rangle - \mathcal{G}_4 \\ d\mathcal{G}_4 = 0 \end{array} \right)_i \quad \begin{array}{l} t_{\mathfrak{so}}^a \mapsto \omega^a \\ r_{\mathfrak{so}}^a \mapsto F_\omega \\ b \mapsto B \\ c \mapsto C_3 \\ h \mapsto H_3 \\ g \mapsto \mathcal{G}_4 \end{array} \quad \left(\begin{array}{l} r_{\mathfrak{so}}^a = dt_{\mathfrak{so}}^a + \frac{1}{2}C_{\mathfrak{so}}^a{}_{bc}t_{\mathfrak{so}}^b \wedge t_{\mathfrak{so}}^c \\ h = db + \text{cs}_{\mathfrak{so}} - c \\ g = dc \\ dr_{\mathfrak{so}}^a = -C^a{}_{bc}t_{\mathfrak{so}}^b \wedge r_{\mathfrak{so}}^c \\ dh = \langle -, - \rangle - g \\ dg = 0 \end{array} \right) .$$

□

Remark 5.5.42. While the 2-form B in the presentation used in the above proof is abelian, the total collection of forms is still connection data with coefficients in the nonabelian Lie 2-algebra \mathfrak{string} . We explained in remark 1.2.185, that there is a choice of local gauge in which the nonabelianness of the 2-form becomes manifest. For the discussion of the above proposition, however, this gauge is not the most convenient one, and it is more convenient to exhibit the local cocycle data in the above form, which corresponds to the second gauge of remark 1.2.185.

This is an example of a general principle in higher nonabelian gauge theory (“higher gerbe theory”). Due to the higher gauge invariances, the local component presentation of a given structure does not usually manifestly exhibit the gauge-invariant information in an obvious way.

Proposition 5.5.43. *Let $\phi \in [\Sigma, \mathbf{BString}_{\text{conn}}]$ be a field configuration which, in the presentation of prop. 5.5.41, is defined over a single patch $U = \Sigma$.*

Then the action functional of def. 5.5.40 sends this to

$$\exp(iS_{8I_8}(\omega, H_3)) = \exp\left(i \int_{\Sigma} \left(-8H_3 \wedge dH_3 + \text{CS}_{\frac{1}{6}\hat{\mathbf{p}}_2}(\omega)\right)\right).$$

Proof. The first term is that of the cup product theory, 5.5.9.1, after using the identity $\text{tr}(F_{\omega} \wedge F_{\omega}) = dH_3$ which holds on the configuration space of String-2-connections by prop. 5.5.41. The second term is that of the $\frac{1}{6}p_2$ -Chern-Simons theory from 5.5.9. \square

Remark 5.5.44. Therefore comparison with equation (5.28) shows that the action functional S_{8I_8} has all the properties that in 5.5.9.3.1 we argued that the effective 7-dimensional Chern-Simons theory inside 11-dimensional supergravity compactified on S^4 should have, in the following special case:

- the C -field flux on S^4 is $N = 8$;

and

- the E_8 -field is trivial;
- the C -field on Σ is trivial.

By choosing any multiple of $8\hat{\mathbf{I}}_8$ one can obtain C -field flux of arbitrary multiples of 8. In order to obtain C -field flux that is not a multiple of 8 one needs to discuss further divisibility of $8\hat{\mathbf{I}}_8$.

We discuss now a refinements of S_{8I_8} that generalize away from the last two of these special conditions to obtain the full form of (5.28).

Recall from def. 5.2.131 the higher moduli stack $C\text{Field}^{\text{bdr}}$ of supergravity C -field configurations, which by remark. 5.2.132 is the moduli 3-stack of twisted $\text{String}^{2\text{a}}$ -connections. We consider now an action functional on this configuration stack.

Following remark 5.1.47 we write a corresponding field configuration, $\phi \in C\text{Field}^{\text{bdr}}(\Sigma)$, whose underlying topological class is trivial as a tuple of forms

$$(\omega, A, B_2, C_3) \in \Omega^1(\Sigma, \mathfrak{so}) \times \Omega^1(\Sigma, \mathfrak{e}_8) \times \Omega^2(\Sigma) \times \Omega^3(\Sigma)$$

and set

$$H_3 := dB_2 + \text{cs}(\omega) - \text{cs}(A).$$

Recall that by prop. 5.1.46 this object has a presentation by Lie integration as 5.2.7.3.1 as a sub-simplicial set

$$\mathbf{cosk}_3 \exp((\mathbb{R} \rightarrow \mathfrak{so} \oplus \mathfrak{e}_8)_{\mu_3^{\text{so}} - 2\mu_3^{\text{e}_8}})_{\text{conn}}.$$

In terms of this presentation we have an evident differential characteristic class given by the Lie integration of the Chern-Simons element $\text{cs}_{\frac{1}{6}p_2} - 8\text{cs}_{\frac{1}{2}p_1 \cup \frac{1}{2}p_1}$.

Definition 5.5.45. Write $\hat{\mathbf{I}}_8$ for the smooth universal characteristic map given by the composite

$$\mathbf{BString}^{2\text{a}} \xrightarrow{\exp(\text{cs}_{\frac{1}{6}p_2} - 8\text{cs}_{\frac{1}{2}p_1 \cup \frac{1}{2}p_1})} [\Sigma, \mathbf{B}^7(\mathbb{R}/K)_{\text{conn}}],$$

where the second morphism is the ∞ -Chern-Weil homomorphism of I_8 , according to 4.4.17, with $K \subset \mathbb{R}$ the given sublattice of periods.

Write

$$\exp(iS_{I_8}(-)) : \mathbf{BString}_{\text{conn}}^{2\text{a}} \xrightarrow{\hat{\mathbf{I}}_8} [\Sigma, \mathbf{B}^7(\mathbb{R}/K)_{\text{conn}}] \xrightarrow{f_{\Sigma}} \mathbb{R}/K$$

for the corresponding action functional.

Finally we obtain the refinement of the 7-dimensional Chern-Simons action (5.28) to the full higher moduli stack of boundary C -field configurations.

Proposition 5.5.46. *Let $\phi \in C\text{Field}^{\text{bdr}}(\Sigma)$ be a boundary C -field configuration according to remark. 5.2.132, whose underlying $\text{String}^{2\mathbf{a}}$ -principal 2-bundle is trivial, which is hence a quadruple of forms*

$$\phi = (\omega, A, B_2, C_3) \in \Omega^1(\Sigma, \mathfrak{so}) \times \Omega^1(\Sigma, \mathfrak{e}_8) \times \Omega^2(\Sigma) \times \Omega^3(\Sigma).$$

The combination of the action functional of def. 5.5.27 and the action functional of def. 5.5.45 sends this to

$$\exp(iS(C_3)) \exp(iS_{8I_8}(\omega, A, B_2)) = \int_{\Sigma} C_3 \wedge dC_3 + 8 \left(H_3 \wedge dH_3 + (H_3 + \text{cs}(A)) \wedge \langle F_{\omega} \wedge F_{\omega} \rangle + \frac{1}{8} \text{cs}_{\frac{1}{8}p_2}(\omega) \right) \text{ mod } K,$$

where $H_3 = dB + \text{cs}(\omega) - 2\text{cs}(A)$.

Proof. By the nature of the $\exp(-)$ -construction we have

$$\exp(iS_{8I_8}(\omega, A, B)) = \int_{\Sigma} \left(8\text{cs}(\omega) \wedge d\text{cs}(\omega) + \text{cs}_{\frac{1}{8}p_2}(\omega) \right) .$$

Inserting here the equation for H_3 satisfied by the $\text{String}^{2\mathbf{a}}$ -connections yields

$$\begin{aligned} \dots &= \int_{\Sigma} \left(8(H_3 + 2\text{cs}(A) - dB) \wedge d(H_3 + 2\text{cs}(A) - dB) + \text{cs}_{\frac{1}{8}p_2}(\omega) \right) \\ &= \int_{\Sigma} \left(8(H_3 + 2\text{cs}(A)) \wedge d(H_3 + 2\text{cs}(A)) + \text{cs}_{\frac{1}{8}p_2}(\omega) \right) . \\ &= \int_{\Sigma} 8 \left(H_3 \wedge dH_3 + (H_3 + 2\text{cs}(A)) \wedge \langle F_{\omega} \wedge F_{\omega} \rangle + \frac{1}{8} \text{cs}_{\frac{1}{8}p_2}(\omega) \right) \end{aligned}$$

□

5.5.10 Action of closed string field theory type

We discuss the form of ∞ -Chern-Simons Lagrangians, 5.5.1, on general L_{∞} -algebras equipped with a quadratic invariant polynomial. The resulting action functionals have the form of that of closed string field theory [Zw93].

Proposition 5.5.47. *Let \mathfrak{g} be any L_{∞} -algebra equipped with a quadratic invariant polynomial $\langle -, - \rangle$.*

The ∞ -Chern-Simons functional associated with this data is

$$S : A \mapsto \int_{\Sigma} \left(\langle A \wedge d_{\text{dR}} A \rangle + \sum_{k=1}^{\infty} \frac{2}{(k+1)!} \langle A \wedge [A \wedge \dots \wedge A]_k \rangle \right),$$

where

$$[-, \dots, -] : \mathfrak{g}^{\otimes k} \rightarrow \mathfrak{g}$$

is the k -ary bracket of \mathfrak{g} (prop. 1.2.145).

Proof. There is a canonical contracting homotopy operator

$$\tau : W(\mathfrak{g}) \rightarrow W(\mathfrak{g})$$

such that $[d_W, \tau] = \text{Id}_{W(\mathfrak{g})}$. Accordingly a Chern-Simons element, def. 4.4.119, for $\langle -, - \rangle$ is given by

$$\text{cs} := \tau \langle -, - \rangle .$$

We claim that this is indeed the Lagrangian for the above action functional.

To see this, first choose a basis $\{t_a\}$ and write

$$P_{ab} := \langle t_a, t_b \rangle$$

for the components of the invariant polynomial in that basis and

$$C_{a_1, \dots, a_k}^a := [t_{a_1}, \dots, t_{a_k}]_k^a$$

as well as

$$C_{a_0, a_1, \dots, a_k} := P_{a_0 a} C_{a_1, \dots, a_k}^a$$

for the structure constant of the k -ary brackets.

In terms of this we need to show that

$$\text{cs} = P_{ab} t^a \wedge d_W t^b + \sum_{k=1}^{\infty} \frac{2}{(k+1)!} C_{a_0, \dots, a_k} t^{a_0} \wedge \dots \wedge t^{a_k}.$$

The computation is best understood via the free dg-algebra $F(\mathfrak{g})$ on the graded vector space \mathfrak{g}^* , which in the above basis we may take to be generated by elements $\{t^a, \mathbf{d}t^a\}$. There is a dg-algebra isomorphism

$$F(\mathfrak{g}) \xrightarrow{\cong} W(\mathfrak{g})$$

given by sending $t^a \mapsto t^a$ and $\mathbf{d}t^a \mapsto d_{\text{CE}(\mathfrak{g})} + r^a$.

On $F(\mathfrak{g})$ the contracting homotopy is evidently given by the map $\frac{1}{L}h$, where L is the word length operator in the above basis and h the graded derivation which sends $t^a \mapsto 0$ and $\mathbf{d}t^a \mapsto t^a$. Therefore τ is given by

$$\begin{array}{ccc} W(\mathfrak{g}) & \xrightarrow{\tau} & W(\mathfrak{g}) \\ \downarrow \simeq & & \uparrow \simeq \\ F(\mathfrak{g}) & \xrightarrow{\frac{1}{L}h} & F(\mathfrak{g}) \end{array}.$$

With this we obtain

$$\begin{aligned} \text{cs} &:= \tau \langle -, - \rangle \\ &= \tau P_{ab} \left(d_W t^a + \sum_{k=1}^{\infty} C_{a_1, \dots, a_k}^a t^{a_1} \wedge \dots \wedge t^{a_k} \right) \wedge \left(d_W t^b + \sum_{k=1}^{\infty} C_{b_1, \dots, b_k}^b t^{b_1} \wedge \dots \wedge t^{b_k} \right) \\ &= P_{ab} t^a \wedge d_W t^b + \sum_{k=1}^{\infty} \frac{2}{k!(k+1)} P_{ab} C_{b_1, \dots, b_k}^b t^a \wedge t^{b_1} \wedge \dots \wedge t^{b_k} \end{aligned}$$

□

Remark 5.5.48. If here Σ is a completely odd-graded dg-manifold, such as $\Sigma = \mathbb{R}^{0|3}$, then this is the kind of action functional that appears in closed string field theory [Zw93][KaSt08]. In this case the underlying space of the (super-) L_∞ -algebra \mathfrak{g} is the BRST complex of the closed (super-)string and $[-, \dots, -]_k$ is the string's tree-level $(k+1)$ -point function.

5.5.11 Non-perturbative AKSZ theory

We now consider *symplectic Lie n -algebroids* \mathfrak{P} . These carry canonical invariant polynomials ω . We show that the ∞ -Chern-Simons action functional associated to such ω is the locally the action functional of the *AKSZ σ -model quantum field theory* with target space \mathfrak{P} (due to [AKSZ97], usefully reviewed in [Roy06]). Globally it is a non-perturbative refinement of the AKSZ σ -model with possibly non-trivial instanton sectors of fields.

This section is based on [FRS11].

- AKSZ σ -models – 5.5.11.1;
- 5.5.11.2 – The AKSZ action as a Chern-Simons functional ;
- 5.5.11.3 – Ordinary Chern-Simons theory;
- 5.5.11.4 – Poisson σ -model;
- 5.5.11.5 – Courant σ -model;
- 5.5.11.6 – Higher abelian Chern-Simons theory.

5.5.11.1 AKSZ σ -Models The class of topological field theories known as *AKSZ σ -models* [AKSZ97] contains in dimension 3 ordinary Chern-Simons theory (see [Fr95] for a comprehensive review) as well as its Lie algebroid generalization (the *Courant σ -model* [Ike03]), and in dimension 2 the Poisson σ -model (see [CaFe00] for a review). It is therefore clear that the AKSZ construction is *some* sort of generalized Chern-Simons theory. Here we demonstrate that this statement is true also in a useful precise sense.

Our discussion proceeds from the observation that the standard Chern-Simons action functional has a systematic origin in Chern-Weil theory (see for instance [GHV73] for a classical textbook treatment and [HoSi05] for the refinement to differential cohomology that we need here):

The refined Chern-Weil homomorphism assigns to any invariant polynomial $\langle - \rangle : \mathfrak{g}^{\otimes n} \rightarrow \mathbb{R}$ on a Lie algebra \mathfrak{g} of compact type a map that sends \mathfrak{g} -connections ∇ on a smooth manifold X to cocycles $[\hat{\mathbf{p}}_{\langle - \rangle}(\nabla)] \in H_{\text{diff}}^{n+1}(X)$ in *ordinary differential cohomology*. These differential cocycles refine the *curvature characteristic class* $[\langle F_{\nabla} \rangle] \in H_{dR}^{n+1}(X)$ in de Rham cohomology to a fully fledged *line n -bundle with connection*, also known as a *bundle $(n-1)$ -gerbe with connection*. And just as an ordinary line bundle (a “line 1-bundle”) with connection assigns holonomy to curves, so a line n -bundle with connection assigns holonomy $\text{hol}_{\hat{\mathbf{p}}}(\Sigma)$ to n -dimensional trajectories $\Sigma \rightarrow X$. For the special case where $\langle - \rangle$ is the Killing form polynomial and $X = \Sigma$ with $\dim \Sigma = 3$ one finds that this volume holonomy map $\nabla \mapsto \text{hol}_{\hat{\mathbf{p}}_{\langle - \rangle}(\nabla)}(\Sigma)$ is precisely the standard Chern-Simons action functional. Similarly, for $\langle - \rangle$ any higher invariant polynomial this holonomy action functional has as Lagrangian the corresponding higher Chern-Simons form. In summary, this means that Chern-Simons-type action functionals on Lie algebra-valued connections are the images of the refined Chern-Weil homomorphism.

In 3.9.7 a generalization of the Chern-Weil homomorphism to *higher* (“derived”) differential geometry has been established. In this context smooth manifolds are generalized first to orbifolds, then to general Lie groupoids, to Lie 2-groupoids and finally to smooth ∞ -groupoids (smooth ∞ -stacks), while Lie algebras are generalized to Lie 2-algebras etc., up to L_{∞} -algebras and more generally to Lie n -algebroids and finally to L_{∞} -algebroids.

In this context one has for \mathfrak{a} any L_{∞} -algebroid a natural notion of \mathfrak{a} -valued ∞ -connections on $\exp(\mathfrak{a})$ -principal smooth ∞ -bundles (where $\exp(\mathfrak{a})$ is a smooth ∞ -groupoid obtained by Lie integration from \mathfrak{a}). By analyzing the abstractly defined higher Chern-Weil homomorphism in this context one finds a direct higher analog of the above situation: there is a notion of invariant polynomials $\langle - \rangle$ on an L_{∞} -algebroid \mathfrak{a} and these induce maps from \mathfrak{a} -valued ∞ -connections to line n -bundles with connections as before .

This construction drastically simplifies when one restricts attention to *trivial* ∞ -bundles with (nontrivial) \mathfrak{a} -connections. Over a smooth manifold Σ these are simply given by dg-algebra homomorphisms

$$A : W(\mathfrak{a}) \rightarrow \Omega^{\bullet}(\Sigma),$$

where $W(\mathfrak{a})$ is the *Weil algebra* of the L_{∞} -algebroid \mathfrak{a} [SSS09a], and $\Omega^{\bullet}(\Sigma)$ is the de Rham algebra of Σ (which is indeed the Weil algebra of Σ thought of as an L_{∞} -algebroid concentrated in degree 0). Then for $\langle - \rangle \in W(\mathfrak{a})$ an invariant polynomial, the corresponding ∞ -Chern-Weil homomorphism is presented by a choice of “Chern-Simons element” $cs \in W(\mathfrak{a})$, which exhibits the *transgression* of $\langle - \rangle$ to an L_{∞} -cocycle (the higher analog of a cocycle in Lie algebra cohomology): the dg-morphism A naturally maps the Chern-Simons

element cs of A to a differential form $cs(A) \in \Omega^\bullet(\Sigma)$ and its integral is the corresponding ∞ -Chern-Simons action functional $S_{\langle - \rangle}$

$$S_{\langle - \rangle} : A \mapsto \text{hol}_{\mathbf{p}_{\langle - \rangle}}(\Sigma) = \int_{\Sigma} cs_{\langle - \rangle}(A).$$

Even though trivial ∞ -bundles with \mathfrak{a} -connections are a very particular subcase of the general ∞ -Chern-Weil theory, they are rich enough to contain AKSZ theory. Namely, here we show that a symplectic dg-manifold of grade n – which is the geometrical datum of the target space defining an AKSZ σ -model – is naturally equivalently an L_∞ -algebroid \mathfrak{P} endowed with a quadratic and non-degenerate invariant polynomial ω of grade n . Moreover, under this identification the canonical Hamiltonian π on the symplectic target dg-manifold is identified as an L_∞ -cocycle on \mathfrak{P} . Finally, the invariant polynomial ω is naturally in transgression with the cocycle π via a Chern-Simons element cs_ω that turns out to be the Lagrangian of the AKSZ σ -model:

$$\int_{\Sigma} L_{\text{AKSZ}}(-) = \int_{\Sigma} cs_\omega(-).$$

(An explicit description of L_{AKSZ} is given below in def. 5.5.50)

In summary this means that we find the following dictionary of concepts:

Chern-Weil theory		AKSZ theory
cocycle	π	Hamiltonian
transgression element	cs	Lagrangian
invariant polynomial	ω	symplectic structure

More precisely, we (explain and then) prove here the following theorem:

Theorem 5.5.49. *For (\mathfrak{P}, ω) an L_∞ -algebroid with a quadratic non-degenerate invariant polynomial, the corresponding ∞ -Chern-Weil homomorphism*

$$\nabla \mapsto \text{hol}_{\mathbf{p}_\omega}(\Sigma)$$

sends \mathfrak{P} -valued ∞ -connections ∇ to their corresponding exponentiated AKSZ action

$$\dots = \exp\left(i \int_{\Sigma} L_{\text{AKSZ}}(\nabla)\right).$$

The local differential form data involved in this statement is at the focus of attention in this section here and contained in prop. 5.5.52 below.

We consider, in definition 5.5.50 below, for any symplectic dg-manifold (X, ω) a functional S_{AKSZ} on spaces of maps $\mathfrak{T}\Sigma \rightarrow X$ of smooth graded manifolds. While only this precise definition is referred to in the remainder of the section, we begin by indicating informally the original motivation of S_{AKSZ} . The reader uncomfortable with these somewhat vague considerations can take note of def. 5.5.50 and then skip to the next section.

Generally, a σ -model field theory is, roughly, one

1. whose fields over a space Σ are maps $\phi : \Sigma \rightarrow X$ to some space X ;
2. whose action functional is, apart from a kinetic term, the transgression of some kind of cocycle on X to the mapping space $\text{Map}(\Sigma, X)$.

Here the terms “space”, “maps” and “cocycles” are to be made precise in a suitable context. One says that Σ is the *worldvolume*, X is the *target space* and the cocycle is the *background gauge field*.

For instance, an ordinary charged particle (such as an electron) is described by a σ -model where $\Sigma = (0, t) \subset \mathbb{R}$ is the abstract *worldline*, where X is a (pseudo-)Riemannian smooth manifold (for instance our spacetime), and where the background cocycle is a line bundle with connection on X (a degree-2 cocycle in ordinary differential cohomology of X , representing a background *electromagnetic field*). Up to a kinetic term, the action functional is the holonomy of the connection over a given curve $\phi : \Sigma \rightarrow X$. A textbook discussion of these standard kinds of σ -models is, for instance, in [DeMo99].

The σ -models which we consider here are *higher* generalizations of this example, where the background gauge field is a cocycle of higher degree (a higher bundle with connection) and where the worldvolume is accordingly higher dimensional. In addition, X is allowed to be not just a manifold, but an approximation to a *higher orbifold* (a smooth ∞ -groupoid).

More precisely, here we take the category of spaces to be SmoothDgMfd from def. 5.3.3. We take target space to be a symplectic dg-manifold (X, ω) and the worldvolume to be the shifted tangent bundle $\mathfrak{T}\Sigma$ of a compact smooth manifold Σ . Following [AKSZ97], one may imagine that we can form a smooth \mathbb{Z} -graded mapping space $\text{Maps}(\mathfrak{T}\Sigma, X)$ of smooth graded manifolds. On this space the canonical vector fields v_Σ and v_X naturally have commuting actions from the left and from the right, respectively, so that their sum $v_\Sigma + v_X$ equips $\text{Maps}(\mathfrak{T}\Sigma, X)$ itself with the structure of a differential graded smooth manifold.

Next we take the “cocycle” on X (to be made precise in the next section) to be the Hamiltonian π (def. 5.3.12) of v_X with respect to the symplectic structure ω , according to def. 5.3.10. One wants to assume that there is a kind of Riemannian structure on $\mathfrak{T}\Sigma$ that allows us to form the transgression

$$\int_{\mathfrak{T}\Sigma} \text{ev}^* \omega := p_! \text{ev}^* \omega$$

by pull-push through the canonical correspondence

$$\text{Maps}(\mathfrak{T}\Sigma, X) \xleftarrow{p} \text{Maps}(\mathfrak{T}\Sigma, X) \times \mathfrak{T}\Sigma \xrightarrow{\text{ev}} X .$$

When one succeeds in making this precise, one expects to find that $\int_{\mathfrak{T}\Sigma} \text{ev}^* \omega$ is in turn a symplectic structure on the mapping space.

This implies that the vector field $v_\Sigma + v_X$ on mapping space has a Hamiltonian

$$\mathbf{S} \in C^\infty(\text{Maps}(\mathfrak{T}\Sigma, X)), \quad \text{s.t.} \quad \mathbf{d}\mathbf{S} = \iota_{v_\Sigma + v_X} \int_{\mathfrak{T}\Sigma} \text{ev}^* \omega .$$

The grade-0 component

$$S_{\text{AKSZ}} := \mathbf{S}|_{\text{Maps}(\mathfrak{T}\Sigma, X)_0}$$

constitutes a functional on the space of morphisms of graded manifolds $\phi : \mathfrak{T}\Sigma \rightarrow X$. This is the *AKSZ action functional* defining the AKSZ σ -model with target space X and background field/cocycle ω .

In [AKSZ97], this procedure is indicated only somewhat vaguely. The focus of attention there is on a discussion, from this perspective, of the action functionals of the 2-dimensional σ -models called the *A-model* and the *B-model*. In [Roy06] a more detailed discussion of the general construction is given, including an explicit formula for \mathbf{S} , and hence for S_{AKSZ} . That formula is the following:

Definition 5.5.50. For (X, ω) a symplectic dg-manifold of grade n with global Darboux coordinates $\{x^a\}$, Σ a smooth compact manifold of dimension $(n + 1)$ and $k \in \mathbb{R}$, the *AKSZ action functional*

$$S_{\text{AKSZ}} : \text{SmoothGrMfd}(\mathfrak{T}\Sigma, X) \rightarrow \mathbb{R}$$

is

$$S_{\text{AKSZ}} : \phi \mapsto \int_{\Sigma} \left(\frac{1}{2} \omega_{ab} \phi^a \wedge d_{\text{dR}} \phi^b - \phi^* \pi \right) ,$$

where π is the Hamiltonian for v_X with respect to ω and where on the right we are interpreting fields as forms on Σ according to prop. 5.3.7.

This formula hence defines an infinite class of σ -models depending on the target space structure (X, ω) . (One can also consider arbitrary relative factors between the first and the second term, but below we shall find that the above choice is singled out). In [AKSZ97], it was already noticed that ordinary Chern-Simons theory is a special case of this for ω of grade 2, as is the Poisson σ -model for ω of grade 1 (and hence, as shown there, also the A-model and the B-model). The main example in [Roy06] spells out the general case for ω of grade 2, which is called the *Courant σ -model* there. (We review and re-derive all these examples in detail below.)

One nice aspect of this construction is that it follows immediately that the full Hamiltonian \mathbf{S} on the mapping space satisfies $\{\mathbf{S}, \mathbf{S}\} = 0$. Moreover, using the standard formula for the internal hom of chain complexes, one finds that the cohomology of $(\text{Maps}(\mathfrak{T}\Sigma, X), v_\Sigma + v_X)$ in degree 0 is the space of functions on those fields that satisfy the Euler-Lagrange equations of S_{AKSZ} . Taken together, these facts imply that \mathbf{S} is a solution of the “master equation” of a BV-BRST complex for the quantum field theory defined by S_{AKSZ} . This is a crucial ingredient for the quantization of the model, and this is what the AKSZ construction is mostly used for in the literature (for instance [CaFe00]).

Here we want to focus on another nice aspect of the AKSZ-construction: it hints at a deeper reason for *why* the σ -models of this type are special. It is indeed one of the very few proposals for what a general abstract mechanism might be that picks out among the vast space of all possible local action functionals those that seem to be of relevance “in nature”.

We now proceed to show that the class of action functionals S_{AKSZ} are precisely those that higher Chern-Weil theory canonically associates to target data (X, ω) . Since higher Chern-Weil theory in turn is canonically given on very general abstract grounds, this in a sense amounts to a derivation of S_{AKSZ} from “first principles”, and it shows that a wealth of very general theory applies to these systems.

5.5.11.2 The AKSZ action as an ∞ -Chern-Simons functional We now show how an L_∞ -algebroid \mathfrak{a} endowed with a triple (π, cs, ω) consisting of a Chern-Simons element transgressing an invariant polynomial ω to a cocycle π defines an AKSZ-type σ -model action. The starting point is to take as target space the tangent Lie ∞ -algebroid $\mathfrak{T}\mathfrak{a}$, i.e., to consider as *space of fields* of the theory the space of maps $\text{Maps}(\mathfrak{T}\Sigma, \mathfrak{T}\mathfrak{a})$ from the worldsheet Σ to $\mathfrak{T}\mathfrak{a}$. Dually, this is the space of morphisms of dgcas from $W(\mathfrak{a})$ to $\Omega^\bullet(\Sigma)$, i.e., the space of degree 1 \mathfrak{a} -valued differential forms on Σ from definition 1.2.169.

Remark 5.5.51. As we noticed in the introduction, in the context of the AKSZ σ -model a degree 1 \mathfrak{a} -valued differential form on Σ should be thought of as the datum of a (nontrivial) \mathfrak{a} -valued connection on a trivial principal ∞ -bundle on Σ .

Now that we have defined the space of fields, we have to define the action. We have seen in definition 1.2.171 that a degree 1 \mathfrak{a} -valued differential form A on Σ maps the Chern-Simons element $\text{cs} \in W(\mathfrak{a})$ to a differential form $\text{cs}(A)$ on Σ . Integrating this differential form on Σ will therefore give an AKSZ-type action which is naturally interpreted as an higher Chern-Simons action functional:

$$\begin{aligned} \text{Maps}(\mathfrak{T}\Sigma, \mathfrak{T}\mathfrak{a}) &\rightarrow \mathbb{R} \\ A &\mapsto \int_{\Sigma} \text{cs}(A). \end{aligned}$$

Theorem 5.5.49 then reduces to showing that, when $\{\mathfrak{a}, (\pi, \text{cs}, \omega)\}$ is the set of L_∞ -algebroid data arising from a symplectic Lie n -algebroid (\mathfrak{P}, ω) , the AKSZ-type action described above is precisely the AKSZ action for (\mathfrak{P}, ω) . More precisely, this is stated as follows.

Proposition 5.5.52. *For (\mathfrak{P}, ω) a symplectic Lie n -algebroid coming by proposition 5.3.15 from a symplectic dg-manifold of positive grade n with global Darboux chart, the action functional induced by the canonical Chern-Simons element*

$$\text{cs} \in W(\mathfrak{P})$$

from proposition 5.3.19 is the AKSZ action from definition 5.5.50:

$$\int_{\Sigma} \text{cs} = \int_{\Sigma} L_{\text{AKSZ}}.$$

In fact the two Lagrangians differ at most by an exact term

$$\text{cs} \sim L_{\text{AKSZ}}.$$

Proof. We have seen in remark 5.3.20 that in Darboux coordinates $\{x^a\}$ where

$$\omega = \frac{1}{2} \omega_{ab} \mathbf{d}x^a \wedge \mathbf{d}x^b$$

the Chern-Simons element from proposition 5.3.19 is given by

$$\text{cs} = \frac{1}{n} \left(\deg(x^a) \omega_{ab} x^a \wedge d_{\mathbb{W}(\mathfrak{P})} x^b - n\pi \right).$$

This means that for Σ an $(n+1)$ -dimensional manifold and

$$\Omega^\bullet(\Sigma) \leftarrow \mathbb{W}(\mathfrak{P}) : \phi$$

a (degree 1) \mathfrak{P} -valued differential form on Σ we have

$$\int_{\Sigma} \text{cs}(\phi) = \frac{1}{n} \int_{\Sigma} \left(\sum_{a,b} \deg(x^a) \omega_{ab} \phi^a \wedge d_{\text{dR}} \phi^b - n\pi(\phi) \right),$$

where we used $\phi(d_{\mathbb{W}(\mathfrak{P})} x^b) = d_{\text{dR}} \phi^b$, as in remark 1.2.170. Here the asymmetry in the coefficients of the first term is only apparent. Using integration by parts on a closed Σ we have

$$\begin{aligned} \int_{\Sigma} \sum_{a,b} \deg(x^a) \omega_{ab} \phi^a \wedge d_{\text{dR}} \phi^b &= \int_{\Sigma} \sum_{a,b} (-1)^{1+\deg(x^a)} \deg(x^a) \omega_{ab} (d_{\text{dR}} \phi^a) \wedge \phi^b \\ &= \int_{\Sigma} \sum_{a,b} (-1)^{(1+\deg(x^a))(1+\deg(x^b))} \deg(x^a) \omega_{ab} \phi^b \wedge (d_{\text{dR}} \phi^a), \\ &= \int_{\Sigma} \sum_{a,b} \deg(x^b) \omega_{ab} \phi^a \wedge (d_{\text{dR}} \phi^b) \end{aligned}$$

where in the last step we switched the indices on ω and used that $\omega_{ab} = (-1)^{(1+\deg(x^a))(1+\deg(x^b))} \omega_{ba}$. Therefore

$$\begin{aligned} \int_{\Sigma} \sum_{a,b} \deg(x^a) \omega_{ab} \phi^a \wedge d_{\text{dR}} \phi^b &= \frac{1}{2} \int_{\Sigma} \sum_{a,b} \deg(x^a) \omega_{ab} \phi^a \wedge d_{\text{dR}} \phi^b + \frac{1}{2} \int_{\Sigma} \sum_{a,b} \deg(x^b) \omega_{ab} \phi^a \wedge d_{\text{dR}} \phi^b \\ &= \frac{n}{2} \int_{\Sigma} \omega_{ab} \phi^a \wedge d_{\text{dR}} \phi^b. \end{aligned}$$

Using this in the above expression for the action yields

$$\int_{\Sigma} \text{cs}(\phi) = \int_{\Sigma} \left(\frac{1}{2} \omega_{ab} \phi^a \wedge d_{\text{dR}} \phi^b - \pi(\phi) \right),$$

which is the formula for the action functional from definition 5.5.50. \square

We now unwind the general statement of proposition 5.5.52 and its ingredients in the central examples of interest, from proposition 5.3.16: the ordinary Chern-Simons action functional, the Poisson σ -model Lagrangian, and the Courant σ -model Lagrangian. (The ordinary Chern-Simons model is the special case of the Courant σ -model for \mathfrak{P} having as base manifold the point. But since it is the archetype of all models considered here, it deserves its own discussion.)

By the very content of proposition 5.5.52 there are no surprises here and the following essentially amounts to a review of the standard formulas for these examples. But it may be helpful to see our general ∞ -Lie theoretic derivation of these formulas spelled out in concrete cases, if only to carefully track the various signs and prefactors.

5.5.11.3 Ordinary Chern-Simons theory Let $\mathfrak{P} = b\mathfrak{g}$ be a semisimple Lie algebra regarded as an L_∞ -algebroid with base space the point and let $\omega := \langle -, - \rangle \in W(b\mathfrak{g})$ be its Killing form invariant polynomial. Then $(b\mathfrak{g}, \langle -, - \rangle)$ is a symplectic Lie 2-algebroid.

For $\{t^a\}$ a dual basis for \mathfrak{g} , being generators of grade 1 in $W(\mathfrak{g})$ we have

$$d_W t^a = -\frac{1}{2} C^a_{bc} t^a \wedge t^b + \mathbf{d}t^a$$

where $C^a_{bc} := t^a([t_b, t_c])$ and

$$\omega = \frac{1}{2} P_{ab} \mathbf{d}t^a \wedge \mathbf{d}t^b,$$

where $P_{ab} := \langle t_a, t_b \rangle$. The Hamiltonian cocycle π from prop. 5.3.17 is

$$\begin{aligned} \pi &= \frac{1}{2+1} \iota_v \iota_\epsilon \omega \\ &= \frac{1}{3} \iota_v P_{ab} t^a \wedge \mathbf{d}t^b \\ &= -\frac{1}{6} P_{ab} C^b_{cd} t^a \wedge t^c \wedge t^d \\ &=: -\frac{1}{6} C_{abc} t^a \wedge t^b \wedge t^c. \end{aligned}$$

Therefore the Chern-Simons element from prop. 5.3.19 is found to be

$$\begin{aligned} \text{cs} &= \frac{1}{2} \left(P_{ab} t^a \wedge \mathbf{d}t^b - \frac{1}{6} C_{abc} t^a \wedge t^b \wedge t^c \right) \\ &= \frac{1}{2} \left(P_{ab} t^a \wedge d_W t^b + \frac{1}{3} C_{abc} t^a \wedge t^b \wedge t^c \right). \end{aligned}$$

This is indeed, up to an overall factor $1/2$, the familiar standard choice of Chern-Simons element on a Lie algebra. To see this more explicitly, notice that evaluated on a \mathfrak{g} -valued connection form

$$\Omega^\bullet(\Sigma) \leftarrow W(b\mathfrak{g}) : A$$

this is

$$2\text{cs}(A) = \langle A \wedge F_A \rangle - \frac{1}{6} \langle A \wedge [A, A] \rangle = \langle A \wedge d_{dR} A \rangle + \frac{1}{3} \langle A \wedge [A, A] \rangle.$$

If \mathfrak{g} is a matrix Lie algebra then the Killing form is proportional to the trace of the matrix product: $\langle t_a, t_b \rangle = \text{tr}(t_a t_b)$. In this case we have

$$\begin{aligned} \langle A \wedge [A, A] \rangle &= A^a \wedge A^b \wedge A^c \text{tr}(t_a(t_b t_c - t_c t_b)) \\ &= 2A^a \wedge A^b \wedge A^c \text{tr}(t_a t_b t_c) \\ &= 2 \text{tr}(A \wedge A \wedge A) \end{aligned}$$

and hence

$$2\text{cs}(A) = \text{tr} \left(A \wedge F_A - \frac{1}{3} A \wedge A \wedge A \right) = \text{tr} \left(A \wedge d_{dR} A + \frac{2}{3} A \wedge A \wedge A \right).$$

5.5.11.4 Poisson σ -model Let $(M, \{-, -\})$ be a Poisson manifold and let \mathfrak{P} be the corresponding Poisson Lie algebroid. This is a symplectic Lie 1-algebroid. Over a chart for the shifted cotangent bundle $T^*[-1]X$ with coordinates $\{x^i\}$ of degree 0 and $\{\partial_i\}$ of degree 1, respectively, we have

$$d_W x^i = -\pi^{ij} \partial_j + \mathbf{d}x^i;$$

where $\pi^{ij} := \{x^i, x^j\}$ and

$$\omega = \mathbf{d}x^i \wedge \mathbf{d}\partial_i.$$

The Hamiltonian cocycle from prop. 5.3.17 is

$$\pi = \frac{1}{2} \iota_v \iota_\epsilon \omega = -\frac{1}{2} \pi^{ij} \partial_i \wedge \partial_j$$

and the Chern-Simons element from prop. 5.3.19 is

$$\begin{aligned} \text{cs} &= \iota_\epsilon \omega + \pi \\ &= \partial_i \wedge \mathbf{d}x^i - \frac{1}{2} \pi^{ij} \partial_i \wedge \partial_j. \end{aligned}$$

In terms of d_W instead of \mathbf{d} this is

$$\begin{aligned} \text{cs} &= \partial_i \wedge d_W x^i - \pi \\ &= \partial_i \wedge d_W x^i + \frac{1}{2} \pi^{ij} \partial_i \partial_j. \end{aligned}$$

So for Σ a 2-manifold and

$$\Omega^\bullet(\Sigma) \leftarrow W(\mathfrak{P}) : (X, \eta)$$

a Poisson-Lie algebroid valued differential form on Σ – which in components is a function $X : \Sigma \rightarrow M$ and a 1-form $\eta \in \Omega^1(\Sigma, X^*T^*M)$ – the corresponding AKSZ action is

$$\int_\Sigma \text{cs}(X, \eta) = \int_\Sigma \eta \wedge d_{\text{dR}} X + \frac{1}{2} \pi^{ij}(X) \eta_i \wedge \eta_j.$$

This is the Lagrangian of the Poisson σ -model [CaFe00].

5.5.11.5 Courant σ -model A Courant algebroid is a symplectic Lie 2-algebroid. By the previous example this is a higher analog of a Poisson manifold. Expressed in components in the language of ordinary differential geometry, a Courant algebroid is a vector bundle E over a manifold M_0 , equipped with: a non-degenerate bilinear form $\langle \cdot, \cdot \rangle$ on the fibers, a bilinear bracket $[\cdot, \cdot]$ on sections $\Gamma(E)$, and a bundle map (called the anchor) $\rho: E \rightarrow TM$, satisfying several compatibility conditions. The bracket $[\cdot, \cdot]$ may be required to be skew-symmetric (Def. 2.3.2 in [Roy02]), in which case it gives rise to a Lie 2-algebra structure, or, alternatively, it may be required to satisfy a Jacobi-like identity (Def. 2.6.1 in [Roy02]), in which case it gives a Leibniz algebra structure.

It was shown in [Roy02] that Courant algebroids $E \rightarrow M_0$ in this component form are in 1-1 correspondence with (non-negatively graded) grade 2 symplectic dg-manifolds (M, v) . Via this correspondence, M is obtained as a particular symplectic submanifold of $T^*[2]E[1]$ equipped with its canonical symplectic structure.

Let (M, v) be a Courant algebroid as above. In Darboux coordinates, the symplectic structure is

$$\omega = \mathbf{d}p_i \wedge \mathbf{d}q^i + \frac{1}{2} g_{ab} \mathbf{d}\xi^a \wedge \mathbf{d}\xi^b,$$

with

$$\deg q^i = 0, \quad \deg \xi^a = 1, \quad \deg p_i = 2,$$

and g_{ab} are constants. The Chevalley-Eilenberg differential corresponds to the vector field:

$$v = P_a^i \xi^a \frac{\partial}{\partial q^i} + g^{ab} \left(P_b^i p_i - \frac{1}{2} T_{bcd} \xi^c \xi^d \right) \frac{\partial}{\partial \xi^a} + \left(-\frac{\partial P_a^j}{\partial q^i} \xi^a p_j + \frac{1}{6} \frac{\partial T_{abc}}{\partial q^i} \xi^a \xi^b \xi^c \right) \frac{\partial}{\partial p_i}.$$

Here $P_a^i = P_a^i(q)$ and $T_{abc} = T_{abc}(q)$ are particular degree zero functions encoding the Courant algebroid structure. Hence, the differential on the Weil algebra is:

$$\begin{aligned} d_W q^i &= P_a^i \xi^a + \mathbf{d}q^i \\ d_W \xi^a &= g^{ab} (P_b^i p_i - \frac{1}{2} T_{bcd} \xi^c \xi^d) + \mathbf{d}\xi^a \\ d_W p_i &= -\frac{\partial P_a^j}{\partial q^i} \xi^a p_j + \frac{1}{6} \frac{\partial T_{abc}}{\partial q^i} \xi^a \xi^b \xi^c + \mathbf{d}p_i. \end{aligned}$$

Following remark. 5.3.18, we construct the corresponding Hamiltonian cocycle from prop. 5.3.17:

$$\begin{aligned} \pi &= \frac{1}{n+1} \omega_{ab} \deg(x^a) x^a \wedge v^b \\ &= \frac{1}{3} (2p_i \wedge v(q^i) + g_{ab} \xi^a \wedge v(\xi^b)) \\ &= \frac{1}{3} (2p_i P_a^i \xi^a + \xi^a P_a^i p_i - \frac{1}{2} T_{abc} \xi^a \xi^b \xi^c) \\ &= P_a^i \xi^a p_i - \frac{1}{6} T_{abc} \xi^a \xi^b \xi^c. \end{aligned}$$

The Chern-Simons element from prop. 5.3.19 is:

$$\begin{aligned} \text{cs} &= \frac{1}{2} \left(\sum_{ab} \deg(x^a) \omega_{ab} x^a \wedge d_W x^b - 2\pi \right) \\ &= p_i d_W q^i + \frac{1}{2} g_{ab} \xi^a d_W \xi^b - \pi \\ &= p_i d_W q^i + \frac{1}{2} g_{ab} \xi^a d_W \xi^b - P_a^i \xi^a p_i + \frac{1}{6} T_{abc} \xi^a \xi^b \xi^c. \end{aligned}$$

So for a map

$$\Omega^\bullet(\Sigma) \leftarrow \mathbf{W}(\mathfrak{P}) : (X, A, F)$$

where Σ is a closed 3-manifold, we have

$$\int_\Sigma \text{cs}(X, A, F) = \int_\Sigma F_i \wedge d_{\text{dR}} X^i + \frac{1}{2} g_{ab} A^a \wedge d_{\text{dR}} A^b - P_a^i A^a \wedge F_i + \frac{1}{6} T_{abc} A^a \wedge A^b \wedge A^c.$$

This is the AKSZ action for the Courant algebroid σ -model from [Ike03] [Roy02][Roy06].

5.5.11.6 Higher abelian Chern-Simons theory in $d = 4k + 3$ We discuss higher abelian Chern-Simons theory, 5.5.8.1, from the point of view of AKSZ theory.

For $k \in \mathbb{N}$, let \mathfrak{a} be the delooping of the line Lie $2k$ -algebra, def. 4.4.61: $\mathfrak{a} = b^{2k+1}\mathbb{R}$. By observation 4.4.117 there is, up to scale, a unique binary invariant polynomial on $b^{2k+1}\mathbb{R}$, and this is the wedge product of the unique generating unary invariant polynomial γ in degree $2k + 2$ with itself:

$$\omega := \gamma \wedge \gamma \in \mathbf{W}(b^{4k+4}\mathbb{R}).$$

This invariant polynomial is clearly non-degenerate: for c the canonical generator of $\text{CE}(b^{2k+1}\mathbb{R})$ we have

$$\omega = \mathbf{d}c \wedge \mathbf{d}c.$$

Therefore $(b^{2k+1}\mathbb{R}, \omega)$ induces an ∞ -Chern-Simons theory of AKSZ σ -model type in dimension $n+1 = 4k+3$. (On the other hand, on $b^{2k}\mathbb{R}$ there is only the 0 binary invariant polynomial, so that no AKSZ- σ -models are induced from $b^{2k}\mathbb{R}$.)

The Hamiltonian cocycle from prop. 5.3.17 vanishes

$$\pi = 0$$

because the differential $d_{\text{CE}(b^{2k+1}\mathbb{R})}$ is trivial. The Chern-Simons element from prop. 5.3.19 is

$$\text{cs} = c \wedge \mathbf{d}c.$$

A field configuration, def. 1.2.169, of this σ -model over a $(2k + 3)$ -dimensional manifold

$$\Omega^\bullet(\Sigma) \leftarrow \text{W}(b^{2k+1}) : C$$

is simply a $(2k + 1)$ -form. The AKSZ action functional in this case is

$$S_{\text{AKSZ}} : C \mapsto \int_{\Sigma} C \wedge d_{\text{dR}} C.$$

The simplicity of this discussion is deceptive. It results from the fact that here we are looking at ∞ -Chern-Simons theory for universal Lie integrations and for topologically trivial ∞ -bundles. More generally the ∞ -Chern-Simons theory for $\mathfrak{a} = b^{2k+1}\mathbb{R}$ is nontrivial and rich, as discussed in 5.5.8.1. Its configuration space is that of *circle $(2k + 1)$ -bundles with connection* (4.4.16) on Σ , classified by ordinary differential cohomology in degree $2k + 2$, and the action functional is given by the fiber integration in differential cohomology to the point over the Beilinson-Deligne cup product, which is locally given by the above formula, but contains global twists.

5.6 Higher Wess-Zumino-Witten field theory

We discuss examples of higher WZW functionals, def. 3.9.12.

This section draws from [FSS13b].

- 5.6.1 – Introduction: Traditional WZW and the need for higher WZW
- 5.6.2 – Lie n -algebraic formulation
- 5.6.3 – Boundary conditions and branes
- 5.6.4 – Super p -branes and the brane bouquet

5.6.1 Introduction: Traditional WZW and the need for higher WZW

For G be a simple Lie group, write \mathfrak{g} for its semisimple Lie algebra. The Killing form invariant polynomial $\langle -, - \rangle : \text{Sym}^2 \mathfrak{g} \rightarrow \mathbb{R}$ induces the canonical Lie algebra 3-cocycle

$$\mu := \langle -, [-, -] \rangle : \text{Alt}^3(\mathfrak{g}) \rightarrow \mathbb{R}$$

which by left-translation along the group defines the canonical closed and left-invariant 3-form

$$\langle \theta \wedge [\theta \wedge \theta] \rangle \in \Omega_{\text{cl,L}}^3(G),$$

where $\theta \in \Omega_{\text{flat}}^1(G, \mathfrak{g})$ is the canonical *Maurer-Cartan form* on G . What is called the *Wess-Zumino-Witten sigma-model* induced by this data (see for instance [Ga00] for a decent review) is the prequantum field theory given by an action functional, which to a smooth map $\Sigma_2 \rightarrow G$ out of a closed oriented smooth 2-manifold assigns the product of the standard exponentiated kinetic action with an exponentiated “surface holonomy” of a 2-form connection whose curvature 3-form is $\langle \theta \wedge [\theta \wedge \theta] \rangle$.

In the special case that $\phi : \Sigma_2 \rightarrow G$ happens to factor through a contractible open subset U of G – notably in the *perturbative expansion* about maps constant on a point – the Poincaré lemma implies that one can find a potential 2-form $B \in \Omega^2(U)$ with $dB = \langle \theta \wedge [\theta \wedge \theta] \rangle|_U$ and with this perturbative perspective understood one may take the action functional to be simply of the naive form that is often considered in the literature:

$$\exp(iS_{\text{WZW}}) := \exp\left(i \int_{\Sigma_2} \mathcal{L}_{\text{WZW}}\right) : \phi \mapsto \exp\left(2\pi i \int_{\Sigma_2} \phi^* B\right).$$

There are plenty of hints and some known examples which point to the fact that this construction of the standard WZW model is just one in a large class of examples of higher dimensional boundary local (pre-)quantum field theories, 3.9.14, which generalize traditional WZW theory in two ways:

1. the cocycle μ is allowed to be of arbitrary degree;
2. the Lie algebra \mathfrak{g} is allowed to be a (super-)Lie n -algebra for $n \geq 1$ (L_∞ -algebra).

One famous class of examples of the first point are the Green-Schwarz type action functionals for the super p -branes of string/M-theory [AETW87]. These are the higher dimensional analog of the action functional for the superstring that was first given in [GrSch84] and then recognized as a super WZW-model in [HeMe85], induced from an exceptional 3-cocycle on super-Minkowski spacetime of bosonic dimension 10, regarded a super-translation Lie algebra. These higher dimensional Green-Schwarz type σ -model action functionals are accordingly induced by higher exceptional super-Lie algebra cocycles on super-Minkowski spacetime, regarded as a super-translation Lie algebra. Remarkably, while ordinary Minkowski spacetime is cohomologically fairly uninteresting, super-Minkowski spacetime has a finite number of *exceptional* super-cohomology classes. The higher dimensional WZW models induced by the corresponding higher exceptional cocycles account precisely for the σ -models of those super- p -branes in string/M-theory which are pure σ -models, in

that they do not carry (higher) gauge fields (“tensor multiplets”) on their worldvolume, a fact known as “the old brane scan” [AETW87]. This includes, for instance, the heterotic superstring and the M2-brane, but excludes the D-branes and the M5-brane.

However, as we discuss below in section 5.6.4, this restriction to pure σ -model branes without “tensor multiplet” fields on their worldvolume is due to the restriction to ordinary super Lie algebras, hence to super Lie n -algebras for just $n = 1$. If one allows genuinely higher WZW models which are given by higher cocycles on Lie n -algebras for higher n , then *all* the fbranes of string/M-theory are described by higher WZW σ -models. This is an incarnation of the general fact that in higher differential geometry, the distinction between σ -models and (higher) gauge theory disappears, as (higher) gauge theories are equivalently σ -models whose target space is a smooth higher moduli *stack*, infinitesimally approximated by a Lie n -algebra for higher n .

This general phenomenon is particularly interesting for the M5-brane (see for instance the Introduction of [FSS12b] for plenty of pointers to the literature on this). According to the higher Chern-Simons-theoretic formulation of AdS₇/CFT₆ in [Wi97b], the 6-dimensional (2, 0)-superconformal worldvolume theory of the M5-brane is related to the 7-dimensional Chern-Simons term in 11-dimensional supergravity compactified on a 4-sphere in direct analogy to the famous relation of 2d WZW theory to the 3d-Chern-Simons theory controlled by the cocycle μ (see [Ga00] for a review). In 5.5.9 and 5.2.9 we have discussed the bosonic non-abelian (quantum corrected) component of this 7d Chern-Simons theory as a higher gauge local prequantum field theory; the discussion here provides the fermionic terms and the formalization of the 6d WZW-type theory induced from a (flat) 7-dimensional Chern-Simons theory.

Up to the last section in this paper we discuss general aspects and examples of higher WZW-type sigma-models in the rational/perturbative approximation, where only the curvature n -form matters while its lift to a genuine cocycle in differential cohomology is ignored. However, in order to define already the traditional WZW action functional in a sensible way on *all* maps to G , one needs a more global description of the WZW term \mathcal{L}_{WZW} . Since [Ga88, FrWi99], this is understood to be a circle 2-connection/bundle gerbe/Deligne 3-cocycle whose curvature 3-form is $\langle \theta \wedge [\theta \wedge \theta] \rangle$, hence a *higher prequantization* [FRS13a] of the curvature 3-form, which we write as a lift of maps of smooth higher stacks

$$\begin{array}{ccc}
 & & \mathbf{B}^2U(1)_{\text{conn}} \\
 & \nearrow \mathcal{L}_{\text{WZW}} & \downarrow H_{(-)} \\
 G & \xrightarrow{\langle \theta \wedge [\theta \wedge \theta] \rangle} & \Omega_{\text{cl}}^3
 \end{array}$$

where $\mathbf{B}^2U(1)_{\text{conn}}$ denotes the smooth 2-stack of smooth circle 2-connections. Then for $\phi : \Sigma_2 \rightarrow G$ a smooth map from a closed oriented 2-manifold to G , the globally defined value of the action functional is the corresponding *surface holonomy* expressed as the composite

$$\exp(iS_{\text{WZW}}) := \exp\left(2\pi i \int_{\Sigma_2} [(-), \mathcal{L}_{\text{WZW}}]\right) : [\Sigma, G] \xrightarrow{[\Sigma, \mathcal{L}_{\text{WZW}}]} [\Sigma, \mathbf{B}^2U(1)_{\text{conn}}] \xrightarrow{\exp(2\pi i \int_{\Sigma_2})(-)} U(1) ,$$

of the functorial mapping stack construction followed by a stacky refinement of fiber integration in differential cohomology, 4.4.18.

Recall that by the discussion in 3.9.12 we have a general universal construction of such non-perturbative refinements of all the local higher WZW terms considered here, and that these are in precise sense boundary local prequantum field theories, 3.9.14.4, for flat higher Chern-Simons type local prequantum field theories (which is in line with the Chern-Simons theoretic holography in [Wi97b]). Therefore we know in principle how to quantize them non-perturbatively in generalized cohomology, discussed below in 6.

5.6.2 Lie n -algebraic formulation of perturbative higher WZW

We start with the traditional WZW model and show how in this example we may usefully reformulate its rationalized/perturbative aspects in terms of Lie n -algebraic structures. Then we naturally and seamlessly

generalize to a definition of higher WZW-type σ -models.

We briefly recall the notion of L_∞ -algebra valued differential forms/connections from to establish notation in the present context. All the actual L_∞ -homotopy theory that we need can be found discussed or referenced in [FRS13b]. Just for simplicity of exposition and since it is sufficient for the present discussion, here we take all L_∞ -algebras to be of finite type, hence degreewise finite dimensional; see [Pr10] for the general discussion in terms of pro-objects.

A (super-)Lie n -algebra, def. 4.6.14, is a (super-) L_∞ -algebra concentrated in the lowest n degrees. Given a (super-) L_∞ -algebra \mathfrak{g} , we write $\text{CE}(\mathfrak{g})$ for its *Chevalley-Eilenberg algebra*; which is a $(\mathbb{Z} \times \mathbb{Z}_2)$ -graded commutative dg-algebra with the property that the underlying graded super-algebra is the free graded commutative super-algebra on the dual graded super vector space $\mathfrak{g}[1]^*$. These are the dg-algebras which in parts of the supergravity literature are referred to as “FDA”s, a term introduced in [Ni83] and then picked up in [dAFR80, dAFr82, CaDAFr91] and followups. Precisely all the (super-)dg-algebras of this *semi-free* form arise as Chevalley-Eilenberg algebras of (super-) L_∞ -algebras this way, and a homomorphism of L_∞ -algebras $f : \mathfrak{g} \rightarrow \mathfrak{h}$ is equivalently a homomorphism of dg-algebras of the form $f^* : \text{CE}(\mathfrak{h}) \rightarrow \text{CE}(\mathfrak{g})$. See [FRS13b] for a review in the context of the higher prequantum geometry of relevance here and for further pointers to the literature on L_∞ -algebras and their homotopy theory.

Definition 5.6.1. For \mathfrak{g} a Lie n -algebra, and X a smooth manifold, a *flat \mathfrak{g} -valued differential form* on X (of total degree 1, with \mathfrak{g} regarded as cohomologically graded) is equivalently a morphism of dg-algebras $A^* : \text{CE}(\mathfrak{g}) \rightarrow \Omega_{\text{dR}}^\bullet(X)$ to the de Rham complex. Dually we write this as¹⁸ $A : X \rightarrow \mathfrak{g}$. These differential forms naturally pull back along maps of smooth manifolds, and we write $\Omega_{\text{flat}}^1(-, \mathfrak{g})$ for the sheaf, on smooth manifolds, of flat \mathfrak{g} -valued differential forms of total degree 1.

Notice that, in general, these forms of total degree 1 involve differential forms of higher degree with coefficients in higher degree elements of the L_∞ -algebra:

Example 5.6.2. For $n \in \mathbb{N}$ write $\mathbb{R}[n]$ for the abelian Lie n -algebra concentrated on \mathbb{R} in degree $-n$. Its Chevalley Eilenberg algebra is the dg-algebra which is genuinely free on a single generator in degree $n + 1$. A flat $\mathbb{R}[n]$ -valued differential form is equivalently just an ordinary closed differential $(n + 1)$ -form

$$\Omega_{\text{flat}}^1(-, \mathbb{R}[n]) \simeq \Omega_{\text{cl}}^{n+1}.$$

Definition 5.6.3. A $(p+2)$ -cocycle μ on a Lie n -algebra \mathfrak{g} is a degree $p+2$ closed element in the corresponding Chevalley-Eilenberg algebra $\mu \in \text{CE}(\mathfrak{g})$.

Remark 5.6.4. A $(p + 2)$ -cocycle on \mathfrak{g} is equivalently a map of dg-algebras $\text{CE}(\mathbb{R}[p + 1]) \rightarrow \text{CE}(\mathfrak{g})$ and hence, equivalently, a map of L_∞ -algebras of the form $\mu : \mathfrak{g} \rightarrow \mathbb{R}[p + 1]$. So, if $\{t_a\}$ is a basis for the graded vector space underlying \mathfrak{g} , then the differential d_{CE} is given in components by

$$d_{\text{CE}} t^a = \sum_{i \in \mathbb{N}} C^a_{a_1 \dots a_i} t^{a_1} \wedge \dots \wedge t^{a_i},$$

where $\{C^a_{a_1 \dots a_i}\}$ are the structure constants of the i -ary bracket of \mathfrak{g} . Consequently, a degree $p + 2$ cocycle is a degree $(p + 2)$ -element

$$\mu = \sum_i \mu_{a_1 \dots a_i} t^{a_1} \wedge \dots \wedge t^{a_i}$$

such that $d_{\text{CE}} \mu = 0$.

Example 5.6.5. For $\{t_a\}$ a basis as above and $\omega \in \Omega_{\text{flat}}^1(X, \mathfrak{g})$ a \mathfrak{g} -valued 1-form on X , the pullback of the cocycle is the closed differential $(p + 2)$ -form which in components reads

$$\mu(\omega) = \sum_i \mu_{a_1 \dots a_i} \omega^{a_1} \wedge \dots \wedge \omega^{a_i},$$

where $\omega^a = \omega(t^a)$.

¹⁸The reader familiar with L_∞ -algebroids should take this as shorthand for the L_∞ -algebroid homomorphism from the tangent Lie algebroid of X to the delooping of the L_∞ -algebra \mathfrak{g} .

Remark 5.6.6. Composition $\omega \mapsto (X \xrightarrow{\omega} \mathfrak{g} \xrightarrow{\mu} \mathbb{R}[p+1])$ of \mathfrak{g} -valued differential forms ω with an L_∞ -cocycle μ yields a homomorphism of sheaves

$$\Omega_{\text{flat}}^1(-, \mu) : \Omega_{\text{flat}}(-, \mathfrak{g}) \longrightarrow \Omega_{\text{cl}}^{p+2} .$$

This is the sheaf incarnation of μ regarded as a universal differential form on the space of all flat \mathfrak{g} -valued differential forms.

Example 5.6.7. By the Yoneda lemma, for X a smooth manifold, morphisms¹⁹ $X \rightarrow \Omega_{\text{flat}}^1(-, \mathfrak{g})$ are equivalently just flat \mathfrak{g} -valued differential forms on X . Specifically, for G an ordinary Lie group, its Maurer-Cartan form is equivalently a map

$$\theta : G \longrightarrow \Omega_{\text{flat}}^1(-, \mathfrak{g}) .$$

Therefore, given a field configuration $\phi : \Sigma_2 \rightarrow G$ of the traditional WZW model, postcomposition with θ turns this into

$$\phi^* \theta : \Sigma \xrightarrow{\phi} G \xrightarrow{\theta} \Omega_{\text{flat}}^1(-, \mathfrak{g}) .$$

Here if \mathfrak{g} is represented as a matrix Lie algebra then this is the popular expression $\phi^* \theta = \phi^{-1} d\phi$

Definition 5.6.8. Given an L_∞ -algebra \mathfrak{g} equipped with a cocycle $\mu : \mathfrak{g} \rightarrow \mathbb{R}[p+1]$ of degree $p+2$, a *perturbative σ -model datum* for (\mathfrak{g}, μ) is a triple consisting of

- a space X ;
- equipped with a flat \mathfrak{g} -valued differential form $\theta_{\text{global}} : X \rightarrow \Omega_{\text{flat}}^1(-, \mathfrak{g})$ (a “global Maurer-Cartan form”);
- and equipped with a factorization \mathcal{L}_{WZW} through d_{dR} of $\mu(\theta_{\text{global}})$, as expressed in the following diagram

$$\begin{array}{ccc} X & \xrightarrow{\theta_{\text{global}}} & \Omega_{\text{flat}}(-, \mathfrak{g}) \xrightarrow{\mu} \Omega_{\text{cl}}^{p+2} . \\ & \searrow \mathcal{L}_{\text{WZW}} & \nearrow d_{\text{dR}} \\ & & \Omega^{p+1} \end{array}$$

The *action functional* associated with this data is the functional

$$S_{\text{WZW}} : [\Sigma, X] \longrightarrow \mathbb{R}$$

given by

$$\phi \mapsto \int_{\Sigma} \mathcal{L}_{\text{WZW}}(\phi) ,$$

where the integrand is the differential form

$$\mathcal{L}_{\text{WZW}}(\phi) : \Sigma \xrightarrow{\phi} X \xrightarrow{\mathcal{L}_{\text{WZW}}} \Omega_{\text{cl}}^{p+1} .$$

Remark 5.6.9. Here X actually need not be a (super-)manifold but may be a smooth higher (super-) stack, 4.6.

¹⁹of sheaves, by thinking of X as the sheaf $C^\infty(-, X)$.

Remark 5.6.10. The notation θ_{global} serves to stress the fact that we are considering globally defined one-forms on X as opposed to cocycles in hypercohomology, which is where the higher Maurer-Cartan forms on *higher* (super-)Lie groups take values, due to presence of nontrivial higher gauge transformations. See 3.9.12.

Remark 5.6.11. The diagram in Def. 5.6.8 manifestly captures a local description, when X is a contractible manifold. An immediate global version is captured by the following diagram

$$\begin{array}{ccccc} \Sigma & \xrightarrow{\eta} & X & \xrightarrow{\theta_{\text{global}}} & \Omega_{\text{flat}}(-, \mathfrak{g}) & \xrightarrow{\mu} & \Omega_{\text{cl}}^{p+2}, \\ & & & \searrow^{\mathcal{L}_{\text{WZW}}} & & \nearrow^{F(-)} & \\ & & & & \mathbf{B}^{p+1}U(1)_{\text{conn}} & & \end{array}$$

where $\mathbf{B}^{p+1}U(1)_{\text{conn}}$ is the stack of $U(1)$ - $(p+1)$ -bundles with connections, and $F_{(-)}$ is the curvature morphism; see, for instance, [FSS10]. This globalization is what one sees, for example, in the ordinary WZW model.

Finally, we notice for discussion in the examples one aspect of the higher symmetries of such perturbative higher WZW models:

Definition 5.6.12. Given a (super-) L_{∞} -algebra \mathfrak{g} , its *graded Lie algebra of infinitesimal automorphisms* is the Lie algebra whose elements are graded derivations $v \in \text{Der}(\text{Sym}^{\bullet} \mathfrak{g}[1]^*)$ on the graded algebra underlying its Chevalley-Eilenberg algebra $\text{CE}(\mathfrak{g})$, acting as the corresponding Lie derivatives.

5.6.3 Boundary conditions and brane intersection laws

In the context of fully extended (i.e. local) topological prequantum field theories, 3.9.14 one has the following general notion of boundary condition, see 3.9.14.4.

Definition 5.6.13. A *prequantum boundary condition for an open brane* (hence a “background brane” on which the given brane may end) is given by boundary gauge trivializations ϕ_{bdr} of the Lagrangian restricted to the boundary fields, hence by diagrams of the form

$$\begin{array}{ccc} & \text{Boundary Field} & \\ & \swarrow & \searrow \\ * & & \text{Bulk Fields} \\ & \swarrow^{\phi_{\text{bdr}}} & \searrow^{\text{Lagrangian}} \\ & 0 & \text{Phases,} \end{array}$$

where “Phases” denotes generally the space where the Lagrangian takes values.

Specializing this general principle to our current situation, we have the following

Definition 5.6.14. A *boundary condition* for a rational σ -model datum, (X, \mathfrak{g}, μ) of Def. 5.6.8, is

1. an L_{∞} -algebra Q and a homomorphism $Q \rightarrow \mathfrak{g}$,
2. equipped with a homotopy ϕ_{bdr} of L_{∞} -algebras morphisms

$$\begin{array}{ccc} & Q & \\ & \swarrow & \searrow \\ * & & \mathfrak{g} \\ & \swarrow^{\phi_{\text{bdr}}} & \searrow^{\mu} \\ & 0 & \mathbb{R}[p+1] \end{array}$$

Remark 5.6.15 (Background branes). Since \mathfrak{g} is to be thought of as the *spacetime target* for a σ -model, we are to think of $Q \rightarrow \mathfrak{g}$ in Def. 5.6.14 as a *background brane* “inside” spacetime. For instance, as demonstrated below in Section 5.6.4, it may be a D-brane in 10-dimensional super-Minkowski space on which the open superstring ends, or it may be the M5-brane in 11-dimensional super-Minkowski spacetime on which the open M2-brane ends. To say then that the p -brane described by the σ -model may end on this background brane Q means to consider worldvolume manifolds Σ_n with boundaries $\partial\Sigma_{p+1} \hookrightarrow \Sigma_{p+1}$ and *boundary field configurations* $(\phi, \phi|_{\partial})$ making the left square in the following diagram commute:

$$\begin{array}{ccccc} \partial\Sigma_{p+1} & \xrightarrow{\phi|_{\partial\Sigma}} & Q & \xrightarrow{\quad} & * \\ \downarrow & & \downarrow & \swarrow \phi_{\text{bdr}} & \downarrow \\ \Sigma_{p+1} & \xrightarrow{\phi} & \mathfrak{g} & \xrightarrow{\mu} & \mathbb{R}[p+1] . \end{array}$$

The commutativity of the diagram on the left encodes precisely that the boundary of the p -brane is to sit inside the background brane Q . But now – by the defining universal property of the homotopy pullback of super L_{∞} -algebras – this means, equivalently, that the background brane embedding map $Q \rightarrow \mathfrak{g}$ factors through the *homotopy fiber* of the cocycle μ . If we denote this homotopy fiber by $\widehat{\mathfrak{g}}$, then we have an essentially unique factorization as follows

$$\begin{array}{ccccc} \partial\Sigma_{p+1} & \xrightarrow{\phi|_{\partial\Sigma}} & Q & \dashrightarrow & \widehat{\mathfrak{g}} & \xrightarrow{\quad} & * \\ \downarrow & & \downarrow & & \downarrow & \swarrow \phi_{\text{bdr}}^{\text{univ.}} & \downarrow \\ \Sigma_{p+1} & \xrightarrow{\phi} & \mathfrak{g} & \xlongequal{\quad} & \widehat{\mathfrak{g}} & \xrightarrow{\mu} & \mathbb{R}[p+1] , \end{array}$$

where now $\widehat{\mathfrak{g}} \rightarrow \mathfrak{g}$ is the *homotopy fiber* $\widehat{\mathfrak{g}}$ of the cocycle μ . Notice that here in homotopy theory *all* diagrams appearing are understood to be filled by homotopies/gauge transformations, but only if we want to label them explicitly do we display them.

The crucial implication to emphasize is that what used to be regarded as a background brane Q on which the σ -model brane Σ_n may end is itself characterized by a σ -model map $Q \rightarrow \widehat{\mathfrak{g}}$, not to the original target space \mathfrak{g} , but to the *extended target space* $\widehat{\mathfrak{g}}$. In the class of examples discussed below in Section 5.6.4, this extended target space is precisely the *extended superspace* in the sense of [CdAIP99].

Remark 5.6.16. The L_{∞} -algebra $\widehat{\mathfrak{g}} \rightarrow \mathfrak{g}$ is the *extension* of \mathfrak{g} classified by the cocycle μ , in generalization to the traditional extension of Lie algebras classified by 2-cocycles. If μ is an $(n_2 + 1)$ -cocycle on an n_1 -Lie algebra \mathfrak{g} for $n_1 \leq n_2$, then the extended L_{∞} -algebra $\widehat{\mathfrak{g}}$ is an Lie n_2 -algebra. See [FRS13b] for more details on this.

Proposition 5.6.17. *The Chevalley-Eilenberg algebra $\text{CE}(\widehat{\mathfrak{g}})$ of the extension $\widehat{\mathfrak{g}}$ of \mathfrak{g} by a cocycle μ admits, up to equivalence, a very simple description; namely, it is the differential graded algebra obtained from $\text{CE}(\mathfrak{g})$ by adding a single generator c_n in degree n subject to the relation*

$$d_{\text{CE}(\widehat{\mathfrak{g}})} c_n = \mu .$$

Here we are viewing μ as a degree $n + 1$ element in $\text{CE}(\mathfrak{g})$, and hence also in $\text{CE}(\widehat{\mathfrak{g}})$.

Proof. First observe that we have a commuting diagram of (super-)dg-algebras of the form

$$\begin{array}{ccc} \text{CE}(\widehat{\mathfrak{g}}) & \longleftarrow & \text{CE}\left(\left(\mathbb{R} \xrightarrow{\text{id}} \mathbb{R}\right)[n-1]\right) \\ \uparrow & & \uparrow \\ \text{CE}(\mathfrak{g}) & \longleftarrow & \text{CE}(\mathbb{R}[n]) \end{array} .$$

Here the top left dg-algebra is the dg-algebra of the above statement, the top morphism is the one that sends the unique degree- $(n + 1)$ -generator to μ and the unique degree- n generator to c_n , the vertical morphisms are the evident inclusions, and the bottom morphism is the given cocycle. Consider the dual diagram of L_∞ -algebras

$$\begin{array}{ccc} \widehat{\mathfrak{g}} & \longrightarrow & (\mathbb{R} \xrightarrow{\text{id}} \mathbb{R})[n - 1] \\ \downarrow & & \downarrow \\ \mathfrak{g} & \xrightarrow{\mu} & \mathbb{R}[n]. \end{array}$$

Then observe that the underlying graded vector spaces here form a pullback diagram of linear maps (the linear components of the L_∞ -morphisms). From this the statement follows directly with the recognition theorem for L_∞ -homotopy fibers, theorem 3.1.13 in [FRS13b]. \square

Remark 5.6.18. The construction appearing in Prop. 5.6.17 is of course well familiar in the “FDA”-technique in the supergravity literature [CaDAFr91], and we recall famous examples below in Section 5.6.4. The point to highlight here is that this construction has a universal L_∞ -homotopy-theoretic meaning, in the way described above.

The crucial consequence of this discussion is the following:

Remark 5.6.19. If the extension $\widehat{\mathfrak{g}}$ itself carries a cocycle $\mu_Q : \widehat{\mathfrak{g}} \rightarrow \mathbb{R}[n]$ and we are able to find a local potential/Lagrangian \mathcal{L}_{WZW} for the closed $(n + 1)$ -form μ_Q (which by 3.9.12 is always the case), then this exhibits the background brane Q itself as a rational WZW σ -model, now propagating not on the original “target spacetime” \mathfrak{g} but on the “extended spacetime” $\widehat{\mathfrak{g}}$.

Remark 5.6.20. Iterating this process gives rise to a tower of extensions and cocycles

$$\begin{array}{ccc} \dots & & \\ \widehat{\widehat{\mathfrak{g}}} & \xrightarrow{\mu_3} & \mathbb{R}[n_3] \\ \downarrow & & \\ \widehat{\mathfrak{g}} & \xrightarrow{\mu_2} & \mathbb{R}[n_2] \\ \downarrow & & \\ \mathfrak{g} & \xrightarrow{\mu_1} & \mathbb{R}[n_1], \end{array}$$

which is like a Whitehead tower in rational homotopy theory, only that the cocycles in each degree here are not required to be the lowest-degree nontrivial ones. In fact, the actual rational Whitehead tower is an example of this. In the language of Sullivan’s formulation of rational homotopy theory this says that \mathfrak{g}_n is exhibited by a sequence of cell attachments as a *relative Sullivan algebra* relative to \mathfrak{g} .

Since this is an important concept for the present purpose, we give it a name:

Definition 5.6.21. Given an L_∞ -algebra \mathfrak{g} , the *brane bouquet* of \mathfrak{g} is the rooted tree consisting of, iteratively, all possible equivalence classes of nontrivial $\mathbb{R}[\bullet]$ extensions (corresponding to equivalence classes of nontrivial $\mathbb{R}[\bullet]$ -cocycles) starting with \mathfrak{g} as the root.

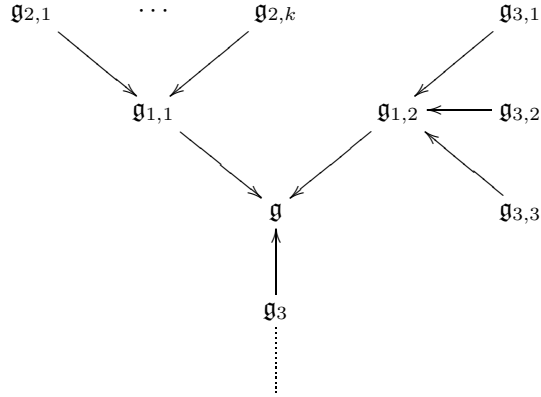

This *brane bouquet* construction in L_∞ -homotopy theory that we introduced serves to organize and formalize the following two physical heuristics.

Remark 5.6.22 (Brane intersection laws). By the discussion above in Remark 5.6.15, each piece of a brane bouquet of the form

$$\begin{array}{ccc}
 \mathfrak{g}_2 & \xrightarrow{\mu_2} & \mathbb{R}[n_2] \\
 \downarrow & & \\
 \mathfrak{g}_1 & \xrightarrow{\mu_1} & \mathbb{R}[n_1]
 \end{array}$$

may be thought of as encoding a *brane intersection law*, meaning that the WZW σ -model brane corresponding to (\mathfrak{g}_1, μ_1) can end on the WZW σ -model brane corresponding to (\mathfrak{g}_2, μ_2) . Therefore, the brane bouquet of some L_∞ -algebra \mathfrak{g} lists all the possible σ -model branes and all their intersection laws in the “target spacetime” \mathfrak{g} .

Remark 5.6.23 (Brane condensates). To see how to think of the extensions $\widehat{\mathfrak{g}}$ as “extended spacetimes”, observe that by Prop. 5.6.17 and Def. 5.6.1 a σ -model on the extension $\widehat{\mathfrak{g}}$ of \mathfrak{g} which is classified by a $(p+2)$ -cocycle μ is equivalently a σ -model on \mathfrak{g} together with an p -form higher gauge field on its worldvolume, one whose curvature $(p+1)$ -form satisfies a twisted Bianchi identity controlled by μ . The examples discussed below in Section 5.6.4 show that this p -form field (“tensor field” in the brane literature) is that which is “sourced” by the charged boundaries of the original σ -model branes on \mathfrak{g} . For instance for superstrings ending on D-branes it is the Chan-Paton gauge field sourced by the endpoints of the open string, and for M2-branes ending on M5-branes it is the latter’s B-field which is sourced by the self-dual strings at the boundary of the M2-brane. In conclusion, this means that we may think of the extension $\widehat{\mathfrak{g}}$ as being the original spacetime \mathfrak{g} but *filled with a condensate* of branes whose σ -model is induced by μ .

5.6.4 Example: Super p -branes and their intersection laws

We now discuss higher rational/perturbative WZW models on super-Minkowski spacetime regarded as the super-translation Lie algebra over itself, as well as on the *extended superspaces* which arise as exceptional super Lie n -algebra extensions of the super-translation Lie algebra. This is the local description of super p -brane σ -models propagating on a supergravity background spacetime, 5.2.8. We show then that by the brane intersection laws of Remark 5.6.22 this reproduces precisely the super p -brane content of string/M-theory including the p -branes with tensor multiplet fields, notably including the D-branes and the M5-brane. The discussion is based on the work initiated in [dAFr82] and further developed in articles including [CdAIP99]. The point here is to show that this “FDA”-technology is naturally and usefully reformulated in terms of super- L_∞ -homotopy theory, and that this serves to clarify and illuminate various points that have not been seen, and are indeed hard to see, via the “FDA”-perspective.

We set up some basic notation concerning the super-translation- and the super-Poincaré super Lie algebras, following [dAFr82]. For more background see lecture 3 of [Fr99] and appendix B of [Po01].

Write $\mathfrak{o}(d-1, 1)$ for the Lie algebra of the Lorentz group in dimension d . If $\{\omega_a{}^b\}_{a,b}$ is the canonical basis of Lie algebra elements, then the Chevalley-Eilenberg algebra $\text{CE}(\mathfrak{o}(d-1, 1))$ is generated from elements $\{\omega_a{}^b\}_{a,b}$ in degree $(1, \text{even})$ with the differential given by²⁰ $d_{\text{CE}} \omega_a{}^b := \omega_a{}^c \wedge \omega_c{}^b$. Next, write $\mathfrak{iso}(d-1, 1)$ for the Poincaré Lie algebra. Its Chevalley-Eilenberg algebra in turn is generated from the $\{\omega_a{}^b\}$ as before together with further generators $\{e^a\}_a$ in degree $(1, \text{even})$ with differential given by $d_{\text{CE}} e^a := \omega_a{}^b \wedge e^b$. Now for N denoting a real spinor representation of $\mathfrak{o}(d-1, 1)$, also called the number of supersymmetries (see for instance part 3 of [Fr99]), write $\{\Gamma^a\}$ for a representation of the Clifford algebra in this representation and $\{\Psi_\alpha\}_\alpha$ for the corresponding basis elements of the spinor representation. There is then an essentially unique symmetric $\text{Spin}(d-1, 1)$ -equivariant bilinear map from two spinors to a vector, traditionally written in components as

$$(\psi_1, \psi_2)^a := \frac{i}{2} \bar{\psi} \Gamma^a \psi.$$

This induces the super Poincaré Lie algebra $\mathfrak{siso}_N(d-1, 1)$ whose Chevalley-Eilenberg super-dg-algebra is generated from the generators as above together with generators $\{\Psi^\alpha\}$ in degree $(1, \text{odd})$ with the differential now defined as follows

$$\begin{aligned} d_{\text{CE}} \omega_a{}^b &= \omega_a{}^c \wedge \omega_c{}^b, \\ d_{\text{CE}} e^a &= \omega_a{}^b \wedge e^b + \frac{i}{2} \bar{\psi} \wedge \Gamma^a \psi, \\ d_{\text{CE}} \psi^\alpha &= \frac{1}{4} \omega_a{}^b \wedge \Gamma^a{}_b \Psi. \end{aligned}$$

Here and in the following $\Gamma^{a_1 \dots a_p}$ denotes the skew-symmetrized product of the Clifford matrices and in the above matrix multiplication is understood whenever the corresponding indices are not displayed. In summary, the degrees are

$$\deg(e^a) = (1, \text{even}), \quad \deg(\omega^a) = (1, \text{even}), \quad \deg(\psi^\alpha) = (1, \text{odd}), \quad \deg(d_{\text{CE}}) = (1, \text{even}).$$

Notice that this means that, for instance, $e^{a_1} \wedge e^{a_2} = -e^{a_2} \wedge e^{a_1}$ and $e^a \wedge \psi^\alpha = -\psi^\alpha \wedge e^a$ but $\psi^{\alpha_1} \wedge \psi^{\alpha_2} = +\psi^{\alpha_2} \wedge \psi^{\alpha_1}$.

Example 5.6.24. For Σ a supermanifold of dimension $(d; N)$, a flat $\mathfrak{siso}(d-1, 1)$ -valued differential form $A : \text{CE}(\mathfrak{siso}(d-1, 1)) \rightarrow \Omega_{\text{dR}}^\bullet(\Sigma)$, according to Def. 5.6.1 and subject to the constraint that the $\mathbb{R}^{d;N}$ -component is induced from the tangent space of Σ (this makes it a *Cartan connection*) is

1. a *vielbein* field $E^a := A(e^a)$,
2. with a *Levi-Civita connection* $\Omega^a{}_b := A(\omega^a{}_b)$ (graviton),
3. a spinor-valued 1-form field $\psi^\alpha := A(\psi^\alpha)$ (gravitino),

subject to the flatness constraints which here say that the torsion of the Levi-Civita connection is the super-torsion $\tau = \bar{\Psi} \wedge \Gamma^a \Psi \wedge E_a$ and that the Riemann curvature vanishes. This is the gravitational field content (for vanishing field strength here, one can of course also consider non-flat fields) of supergravity on Σ , formulated in first order formalism. By passing to L_∞ -extensions of \mathfrak{siso} this is the fomulation of supergravity fields which seamlessly generalizes to the higher gauge fields that higher supergravities contain, including their correct higher gauge transformations. This is the perspective on supergravity originating around the article [dAFr82] and expanded on in the textbook [CaDAFr91]. Recognizing the “FDA”-language used in this book as secretly being about Lie n -algebra homotopy theory (the “FDA”s are really Chevalley-Eilenberg algebras super- L_∞ -algebras) allows one to uncover some natural and powerful higher gauge theory and geometric homotopy theory hidden in traditional supergravity literature.

The *super translation Lie algebra* corresponding to the above is the quotient

$$\mathbb{R}^{d;N} := \mathfrak{siso}(d-1, 1) / \mathfrak{o}(d-1, 1)$$

²⁰Here and in all of the following a summation over repeated indices is understood.

whose CE-algebra is as above but with the $\{\omega^a{}_b\}$ discarded. We may think of the underlying super vector space of $\mathbb{R}^{d;N}$ as N -super Minkowski spacetime of dimension d , i.e. with N supersymmetries. Regarded as a supermanifold, it has canonical super-coordinates $\{x^a, \vartheta^\alpha\}$ and the CE-generators e^a and ψ^α above may be identified under the general equivalence $\text{CE}(\mathfrak{g}) \simeq \Omega_{\mathbb{L}}^\bullet(G)$ (for a (super-)Lie group G with (super-)Lie algebra \mathfrak{g}) with the corresponding canonical left-invariant differential forms on this supermanifold:

$$\begin{aligned} e^a &= d_{\text{dR}} x^a + \overline{\vartheta} \Gamma^a d_{\text{dR}} \vartheta, \\ \psi^\alpha &= d_{\text{dR}} \vartheta^\alpha. \end{aligned}$$

This defines a morphism $\theta : \text{CE}(\mathbb{R}^{d;N}) \rightarrow \Omega^{\bullet|\bullet}(\mathbb{R}^{d;N})$ to super-differential forms on super Minkowski space, and via Def. 5.6.1 this is the Maurer-Cartan form, Example 5.6.7, on the supergroup $\mathbb{R}^{d;N}$ of supertranslations. As such $\{e^a, \psi^\alpha\}$ is the canonical *super-vielbein* on super-Minkowski spacetime.

Notice that the only non-trivial piece of the above CE-differential remaining on $\text{CE}(\mathbb{R}^{d;N})$ is

$$d_{\text{CE}(\mathbb{R}^{d;N})} e^a = \overline{\psi} \wedge \Gamma^a \psi.$$

Dually this is the single non-trivial super-Lie bracket on $\mathbb{R}^{d;N}$, the one which pairs two spinors to a vector. All the exceptional cocycles considered in the following exclusively are controlled by just this equation and Lorentz invariance.

We next consider various branches of the brane bouquet, Def. 5.6.37, of these super-spacetimes $\mathbb{R}^{d;N}$.

- 5.6.4.1 $-\sigma$ -model super p -branes — The old brane scan
- 5.6.4.2 – Type IIA superstring ending on D-branes and the D0-brane condensate
- 5.6.4.3 – Type IIB superstring ending on D-branes and S-duality
- 5.6.4.4 – The M-theory 5-brane and the M-theory super Lie algebra
- 5.6.4.5 – The complete brane bouquet of string/M-theory

5.6.4.1 Σ -model super p -branes — The old brane scan As usual, we write N for a choice of number of irreducible real (Majorana) representations of $\text{Spin}(d-1, 1)$, and $N = (N_+, N_-)$ if there are two inequivalent chiral minimal representations. For instance, two important cases are

$d = 10$	$d = 11$
$N = (1, 0) = \mathbf{16}$	$N = 1 = \mathbf{32}$

For $0 \leq p \leq 9$ consider the dual bispinor element

$$\mu_p := e^{a_1} \wedge \cdots \wedge e^{a_p} \wedge (\overline{\psi} \wedge \Gamma^{a_1 \cdots a_p} \psi) \in \text{CE}(\mathbb{R}^{d;N}),$$

where here and in the following the parentheses are just to guide the reader's eye. Observe that the differential of this element is of the form

$$d_{\text{CE}} \mu_p \propto e^{a_1} \wedge \cdots \wedge e^{a_{p-1}} \wedge (\overline{\psi} \Gamma^{a_1 \cdots a_p} \psi) \wedge (\overline{\psi} \wedge \Gamma^{a_p} \psi).$$

This is zero precisely if after skew-symmetrization of the indices, the spinorial expression

$$\overline{\psi} \Gamma^{[a_1 \cdots a_p} \psi \wedge \overline{\psi} \wedge \Gamma^{a_p]} \psi = 0$$

vanishes identically (on all spinor components). The spinorial relations which control this are the *Fierz identities*. If this expression vanishes, then μ_p is a $(p+2)$ -cocycle on $\mathbb{R}^{d;N=1}$, Def. 5.6.3, hence a homomorphism of super Lie n -algebras of the form

$$\mu_p : \mathbb{R}^{d;N=1} \longrightarrow \mathbb{R}[p+1].$$

If this is the case then, by Def. 5.6.8, this defines a σ -model p -brane propagating on $\mathbb{R}^{d;N=1}$.

The combinations of d and p for which this is the case had originally been worked out in [AETW87]. The interpretation in terms of super-Lie algebra cohomology was clearly laid out in [AzTo89]. See [Br10a, Br10b, Br13] for a rigorous treatment and comprehensive classification for all N . The non-trivial cases (those where μ_p is closed but not itself a differential) correspond precisely to the non-empty entries in the following table.

$d \backslash p$	1	2	3	4	5	6	7	8	9
11		(1) m2brane							
10	(1,0) string_{het}				(1,0) ns5brane_{het}				
9				(1)					
8			(1)						
7		(1)							
6	(1,0) littlestring		(1,0)						
5		(1)							
4	(1)	(1)							
3	(1)								

This table is known as the “old brane scan” for string/M-theory. Each non-empty entry corresponds to a p -brane WZW-type σ -model action functional of Green-Schwarz type. For $(d = 10, p = 1)$ this is the original Green-Schwarz action functional for the superstring [GrSch84] and, therefore, we write **string_{het}** in the respective entry of the table (similarly there are cocycles for type II strings, discussed in the following sections), which at the same time is to denote the super Lie 2-algebra extension of $\mathbb{R}^{10,N=1}$ that is classified by μ_p in this dimension, according to Remark 5.6.16:

$$\begin{array}{ccc} \mathbf{string}_{\text{het}} & & \\ \downarrow & & \\ \mathbb{R}^{10;N=(1,0)} & \xrightarrow{\mu_1} & \mathbb{R}[2] . \end{array}$$

This Lie 2-algebra has been highlighted in [BaH10].

Analogously we write **m2brane** for the super Lie 3-algebra extension of $\mathbb{R}^{11;N=1}$ classified by the nontrivial cocycle μ_2 in dimension 11 (this was called the *supergravity Lie 3-algebra sugra₁₁* in [SSS09a])

$$\begin{array}{ccc} \mathbf{m2brane} & & \\ \downarrow & & \\ \mathbb{R}^{11;N=1} & \xrightarrow{\mu_2} & \mathbb{R}[3] , \end{array}$$

and so on.

While it was a pleasant insight back then that so many of the extended objects of string/M-theory do appear from just super-Lie algebra cohomology this way in the above table, it was perhaps just as curious that not all of them appeared. Later other tabulations of string/M-branes were compiled, based on less

mathematically well defined physical principles [Duf08]. These “new brane scans” are what make the above an “old brane scan”. But we will show next that if only we allow ourselves to pass from (super-)Lie algebra theory to (super-) Lie n -algebra theory, then the old brane scan turns out to be part of a brane bouquet that accurately incorporates all the information of the “new brane scan”, all the branes of the new brane scan, altogether with their intersection laws, with their tensor multiplet field content and its correct higher gauge transformation laws.

5.6.4.2 Type IIA superstring ending on D-branes and the D0-brane condensate We consider the branes in type IIA string theory and point out how their L_∞ -homotopy theoretic formulation serves to provide a formal statement and proof of the folklore relation between type IIA string theory with a D0-brane condensate and M-theory.

Write $N = (1, 1) = \mathbf{16} + \mathbf{16}'$ for the Dirac representation of $\text{Spin}(9, 1)$ given by two 16-dimensional real irreducible representations of opposite chirality. We write $\{\Gamma^a\}_{a=1, \dots, 10}$ for the corresponding representation of the Clifford algebra and $\Gamma^{11} := \Gamma^1 \Gamma^2 \cdots \Gamma^{10}$ for the chirality operator. Finally write $\mathbb{R}^{10; N=(1,1)}$ for the corresponding super-translation Lie algebra, the super-Minkowski spacetime of type IIA string theory.

Definition 5.6.25. The type IIA 3-cocycle is

$$\mu_{\text{string}_{\text{IIA}}} := \bar{\psi} \wedge \Gamma^a \Gamma^{11} \psi \wedge e^a \quad : \quad \mathbb{R}^{10; N=(1,1)} \longrightarrow \mathbb{R}[2] .$$

The type IIA superstring super Lie 2-algebra is the corresponding super L_∞ -extension

$$\begin{array}{ccc} & \text{string}_{\text{IIA}} & \\ & \downarrow & \\ \mathbb{R}^{10; N=(1,1)} & \xrightarrow{\mu_{\text{string}_{\text{IIA}}}} & \mathbb{R}[2] . \end{array}$$

Its Chevalley-Eilenberg algebra is that of $\mathbb{R}^{10; N=(1,1)}$ with one generator F in degree $(2, \text{even})$ adjoined and with its differential being

$$d_{\text{CE}} F = \mu_{\text{string}_{\text{IIA}}} = \bar{\psi} \wedge \Gamma^a \Gamma^{11} \psi \wedge e^a .$$

This dg-algebra appears as equation (6.3) in [CdAIP99]. It can also be deduced from op.cit. that the IIA string Lie 2-algebra of Def. 5.6.25 carries exceptional cocycles of degrees $p + 2 \in \{2, 4, 6, 8, 10\}$ of the form

$$\begin{aligned} \mu_{\text{Dpbrane}} &:= C \wedge e^F \\ &:= \sum_{k=0}^{(p+2)/2} c_k^p (e^{a_1} \wedge \cdots \wedge e^{a_{p-2k}}) \wedge (\bar{\psi} \Gamma^{a_1} \cdots \Gamma^{a_{p-2k}} \Gamma^{11} \psi) \underbrace{F \wedge \cdots \wedge F}_{k \text{ factors}} , \end{aligned} \tag{5.29}$$

where $\{c_k^p \in \mathbb{R}\}$ are some coefficients, and where C denotes the inhomogeneous element of $\text{CE}(\mathbb{R}^{10; N=(1,1)})$ defined by the second line. For each $p \in \{0, 2, 4, 6, 8\}$ there is, up to a global rescaling, a unique choice of the coefficients c_k^p that make this a cocycle. This is shown on p. 19 of [CdAIP99].

Remark 5.6.26. Here the identification with physics terminology is as follows

- F is the field strength of the *Chan-Paton gauge field* on the D-brane, a “tensor field” that happens to be a “vector field”;
- $C = \sum_p k^p \bar{\psi} \underbrace{e \wedge \cdots \wedge e}_p \psi$ is the *RR-field*.

It is interesting to notice the special nature of the cocycle for the D0-brane:

Remark 5.6.27. According to (5.29) for $p = 0$, the cocycle defining the D0-brane as a higher WZW σ -model is just

$$\mu_{\text{D0brane}} = \overline{\psi} \Gamma^{11} \psi .$$

Since this independent of the generator F , it restricts to a cocycle on just $\mathbb{R}^{10;N=(1,1)}$ itself.

Concerning this, we highlight the following fact, which is mathematically elementary but physically noteworthy (see also Section 2.1 of [CdAIP99]), as it has conceptual consequences for arriving at M-theory starting from type IIA string theory.

Proposition 5.6.28. *The extension of 10-dimensional type IIA super-Minkowski spacetime $\mathbb{R}^{10;N=(1,1)}$ by the D0-brane cocycle as in Remark 5.6.27 is the 11-dimensional super-Minkowski spacetime of 11-dimensional supergravity/M-theory:*

$$\begin{array}{ccc} \mathbb{R}^{11;N=1} & & \\ \downarrow & & \\ \mathbb{R}^{10;N=(1,1)} & \xrightarrow{\mu_{\text{D0brane}}} & \mathbb{R}[1] . \end{array}$$

Proof. By Prop. 5.6.17 the Chevalley-Eilenberg algebra of the extension classified by μ_{D0brane} is that of $\mathbb{R}^{10;N=(1,1)}$ with one new generator e^{11} in degree $(1, \text{even})$ adjoined and with its differential defined to be

$$d_{\text{CE}} e^{11} = \mu_{\text{D0brane}} = \overline{\psi} \Gamma^{11} \psi .$$

An elementary basic fact of Spin representation theory says that the $N = 1$ -representation of the Spin group $\text{Spin}(10, 1)$ in odd dimensions is the $N = (1, 1)$ -representation of the even dimensional Spin group $\text{Spin}(9, 1)$ regarded as a representation of the Clifford algebra $\{\Gamma^a\}_{a=1}^{10}$ with Γ^{11} adjoined as in Def. 5.6.25. Using this, the above extended CE-algebra is exactly that of $\mathbb{R}^{11;N=1}$. \square

Remark 5.6.29. In view of Remark 5.6.23 the content of Prop. 5.6.28 translates to heuristic physics language as: *A condensate of D0-branes turns the 10-dimensional type IIA super-spacetime into the 11-dimensional spacetime of 11d-supergravity/M-theory. Alternatively: The condensation of D0-branes makes an 11th dimension of spacetime appear.*

In this form the statement is along the lines of the standard folklore relation between type IIA string theory and M-theory, which says that type IIA with N D0-branes in it is M-theory compactified on a circle whose radius scales with N ; see for instance [BFSS96, Po99]. See also [Ko11] for similar remarks motivated from phenomena in 2-dimensional boundary conformal field theory. Here in the formalization via higher WZW σ -models a version of this statement becomes a theorem, Prop. 5.6.28.

Remark 5.6.30. The mechanism of remark 5.6.29 appears at several places in the brane bouquet. First of all, since by Prop. 5.29 the D0-brane cocycle is a summand in each type IIA D-brane cocycle, it follows via the above translation from L_∞ -homotopy theory to physics language that: *Any type IIA D-brane condensate extends 10-dimensional type IIA super-spacetime to 11-dimensional super-spacetime.* If we lift attention again from the special case of D-branes of type IIA string theory to general higher WZW-type σ -models, then this mechanism is seen to generalize: the 10-dimensional super-Minkowski spacetime itself is an extension of the *super-point* by 10-cocycles (one for each dimension):

$$\begin{array}{ccc} \mathbb{R}^{10;N=(1,1)} & & \\ \downarrow & & \\ \mathbb{R}^{0;N=(1,1)} & \xrightarrow{\sum_{a=1}^{10} \overline{(-)} \Gamma^a (-)} & \mathbb{R}[1] . \end{array}$$

Here the cocycle describes 10 different 0-brane σ -models, each propagating on the super-point as their target super-spacetime. Again, by remark 5.6.23, this mathematical fact is a formalization and proof of what in physics language is the statement that *Spacetime itself emerges from the abstract dynamics of 0-branes*. This is close to another famous folklore statement about string theory. In our context it is a theorem.

5.6.4.3 Type IIB superstring ending on D-branes and S-duality We consider the branes in type IIB string theory as examples of higher WZW-type σ -model field theories and observe how their L_∞ -homotopy theoretic formulation serves to provide a formal statement of the prequantum S-duality equivalence between F-strings and D-strings and their unification as (p, q) -string bound states.

Write $N = (2, 0) = \mathbf{16} + \mathbf{16}$ for the direct sum representation of $\text{Spin}(9, 1)$ given by two 16-dimensional real irreducible representations of the same chirality. We write $\{\Gamma^a\}_{a=1, \dots, 10}$ for the corresponding representation of the Clifford algebra on one copy of $\mathbf{16}$ and $\Gamma^a \otimes \sigma^i$ for the linear maps on their direct sum representation that act as the i th Pauli matrix on \mathbb{C}^2 with components Γ^a , under the canonical identification $\mathbf{16} \oplus \mathbf{16} \simeq \mathbf{16} \otimes \mathbb{C}^2$. Finally write $\mathbb{R}^{10; N=(2,0)}$ for the corresponding super-translation Lie algebra, the super-Minkowski spacetime of type IIB string theory.

There is a cocycle $\mu_{\text{string}_{\text{IIB}}} \in \text{CE}(\mathbb{R}^{10; N=(2,0)})$ given by

$$\mu_{\text{string}_{\text{IIB}}} = \bar{\psi} \wedge (\Gamma^a \otimes \sigma^3) \psi \wedge e^a .$$

The corresponding WZW σ -model is the Green-Schwarz formulation of the fundamental type IIB string. Of course we could use in this formula any of the σ^i , but one fixed such choice we are to call the type IIB string. That the other choices are equivalent is the statement of *S-duality*, to which we come in a moment. The corresponding L_∞ -algebra extension, hence by Remark 5.6.23 the IIB spacetime “with string condensate” is the homotopy fiber

$$\begin{array}{ccc} \text{string}_{\text{IIB}} & & \\ \downarrow & & \\ \mathbb{R}^{10; N=(2,0)} & \xrightarrow{\mu_{\text{string}_{\text{IIB}}}} & \mathbb{R}[2] . \end{array}$$

As for type IIA, its Chevalley-Eilenberg algebra $\text{CE}(\text{string}_{\text{IIB}})$ is that of $\mathbb{R}^{10; N=(2,0)}$ with one generator F in degree $(2, \text{even})$ adjoined. The differential of that is now given by

$$\begin{aligned} d_{\text{CE}} F &= \mu_{\text{string}_{\text{IIB}}} \\ &= \bar{\psi} \wedge (\Gamma^a \otimes \sigma^3) \psi \wedge e_a . \end{aligned}$$

Now this Lie 2-algebra itself carries exceptional cocycles of degree $(p+2)$ for $p \in \{1, 3, 5, 7, 9\}$ of the form

$$\begin{aligned} \mu_{\text{D}p\text{brane}} &:= C \wedge e^F \\ &:= \sum_{k=0}^{(p+2)/2+1} c_k^p (e^{\alpha_1} \wedge \dots \wedge e^{\alpha_{p-2k}}) \wedge \left(\bar{\psi} \wedge (\Gamma^{\alpha_1} \dots \Gamma^{\alpha_{p-2k}} \otimes \sigma^{1/2}) \psi \right) \underbrace{F \wedge \dots \wedge F}_{k \text{ factors}} , \end{aligned} \quad (5.30)$$

where on the right the notation $\sigma^{1/2}$ is to mean that σ^1 appears in summands with an odd number of generators “ e ”, and σ^2 in the other summands. The corresponding WZW models are those of the type IIB D-branes.

Remark 5.6.31. According to expression (5.30) the cocycle of the D1-brane is of the form

$$\mu_{\text{D1brane}} = \bar{\psi} \wedge (\Gamma^a \otimes \sigma^1) \wedge e^a ,$$

which is the same form as that of $\mu_{\text{string}_{\text{IIB}}}$ itself, only that σ^3 is replaced by σ^1 . In fact since this is the D-brane cocycle which is independent of the new generator F , it restricts to a cocycle on just $\mathbb{R}^{10; N=(2,0)}$ itself. So the cocycle for the “F-string” in type IIB is on the same footing as that of the “D-string”. Both differ only by a “rotation” in an internal space.

Remark 5.6.32. There is a circle worth of L_∞ -automorphisms

$$S(\alpha) : \mathbb{R}^{10;N=(2,0)} \rightarrow \mathbb{R}^{10;N=(2,0)} ,$$

hence a group homomorphism

$$U(1) \rightarrow \text{Aut}(\mathbb{R}^{10;N=(2,0)}) ,$$

given dually on Chevalley-Eilenberg algebras by

$$\begin{aligned} e^a &\mapsto e^a \\ \psi &\mapsto \exp(\alpha\sigma^2)\psi . \end{aligned}$$

This mixes the cocycles for the F-string and for the D-string in that for a quarter rotation it turns one into the other

$$S(\pi/4)^*(\mu_{\text{string}_{\text{IIA}}}) = \mu_{\text{D1brane}} ,$$

and for a rotation by a general angle it produces a corresponding superposition of both. In particular, we can form *bound states* of F -strings and D1-branes by adding these cocycles

$$\mu_{(p,q)\text{string}} = p\mu_{\text{string}_{\text{IIB}}} + q\mu_{\text{D1brane}} \in \text{CE}(\mathbb{R}^{10;N=(2,0)}) .$$

These define the (p, q) -string bound states as WZW-type σ -models.

5.6.4.4 The M-theory 5-brane and the M-theory super Lie algebra We discuss here the single M5-brane as a higher WZW-type σ -model, show that it is defined by a 7-cocycle on the M2-brane super Lie-3 algebra and observe that this 7-cocycle is indeed the relevant fermionic 7d Chern-Simons term of 11-dimensional supergravity compactified on S^4 , as required by $\text{AdS}_7/\text{CFT}_6$ in the Chern-Simons interpretation of [Wi97b]. We see that the truncation of the symmetry algebra of this higher 5-brane superalgebra to degree 0 is the ‘‘M-algebra’’.

Write $N = 1 = \mathbf{32}$ for the irreducible real representation of $\text{Spin}(10, 1)$. Write $\{\Gamma^a\}_{a=1}^{11}$ for the corresponding representation of the Clifford algebra. Finally write $\mathbb{R}^{11;N=1}$ for the corresponding super-translation Lie algebra. According to the old brane scan in section 5.6.4.1, the exceptional Lorentz-invariant cocycle for the M2-brane is

$$\mu_{\text{m2brane}} = \bar{\psi} \wedge \Gamma^{ab}\psi \wedge e^a \wedge e^b .$$

The Green-Schwarz action functional for the M2-brane is the σ -model defined by this cocycle

$$\mathbb{R}^{11;N} \xrightarrow{\mu_{\text{m2brane}}} \mathbb{R}[3] .$$

By the L_∞ -theoretic brane intersection law of Remark 5.6.22, for the M2-brane to end on another kind of brane, that other WZW model is to have the extended spacetime μ_{m2brane} (the original spacetime including a condensate of M2s) as its target space. By Prop. 5.6.17, the Chevalley-Eilenberg algebra of the M2-brane algebra is obtained from that of the super-Poincaré Lie algebra by adding one more generator c_3 with $\text{deg}(c_3) = (3, \text{even})$ with differential defined by

$$\begin{aligned} d_{\text{CE}} c_3 &:= \mu_{\text{m2brane}} \\ &= \bar{\psi} \wedge \Gamma^{ab}\psi \wedge e^a \wedge e^b . \end{aligned}$$

We can then define an extended spacetime Maurer-Cartan form $\hat{\theta}$ in $\Omega_{\text{flat}}^1(\mathbb{R}^{11;N}, \mathbf{m2brane})$, extending the canonical Maurer-Cartan form θ in $\Omega_{\text{flat}}^1(\mathbb{R}^{11;N}, \mathbb{R}^{d;N})$, by picking any 3-form $C_3 \in \Omega^3(\mathbb{R}^{11;N})$ such that $d_{\text{dR}} C_3 = \bar{\psi} \Gamma^{ab} \wedge \psi \wedge e^a \wedge e^b$.

Next, for every $(n + 1)$ cocycle on **m2brane** we get an n -dimensional WZW model defined on $\mathbb{R}^{11;N}$ this way. In particular, the next one we meet is the M5-brane cocycle. Indeed, there is the degree-7 cocycle

$$\mu_7 = \bar{\psi}\Gamma^{a_1 \dots a_5} \psi e^{a_1} \wedge \dots \wedge e^{a_5} + C_3 \wedge \bar{\psi}\Gamma^{ab} \psi \wedge e^a \wedge e^b : \mathbf{m2brane} \longrightarrow \mathbb{R}[6]$$

that was first observed in [dAFr82], then rediscovered several times, for instance in [Sez96], in [BLNPST97] and in [CdAIP99]. Here we identify it as an L_∞ 7-cocycle on the **m2brane** super Lie 3-algebra. The L_∞ -extension of **m2brane** associated with the 7-cocycle is a super Lie 6-algebra that we call **m5brane**.

It follows from this, with remark 5.6.22, that the M2-brane may end on a M5-brane whose WZW term \mathcal{L}_{WZW} locally satisfies

$$d\mathcal{L}_{\text{WZW}} = \mu_7 = \bar{\psi}\Gamma^{a_1 \dots a_5} \psi e^{a_1} \wedge \dots \wedge e^{a_5} + C_3 \wedge \bar{\psi}\Gamma^{ab} \psi \wedge e^a \wedge e^b$$

This is precisely what in [BLNPST97] is argued to be the action functional of the M5-brane (here displayed in the absence of the bosonic contribution of the C-field). However, in order to get the expected structure of gauge transformations, we need to go further. Namely, while the above local expression for the action functional appears to be correct on the nose, its gauge transformations are not as expected for the M5: for the M5-brane worldvolume theory the 2-form with curvature C_3 is supposed to be a genuine higher 2-form gauge field on the worldvolume, directly analogous to the Neveu-Schwarz B-field of 10-dimensional supergravity spacetime; see [FSS12b]. As such, it is to have gauge transformations parameterized by 1-forms. But in the above formulation fields are maps $\Sigma_6 \rightarrow \mathbb{R}^{11;N}$ into spacetime itself, and as such have no gauge transformations at all. We can fix this by finding a better space \hat{X} . In fact we should take that to be **m2brane** itself. As indicated above, this is an extension

$$\mathbb{R}[2] \longrightarrow \mathbf{m2brane} \longrightarrow \mathbb{R}^{11;N} ,$$

and, hence, a twisted product of spacetime with $\mathbb{R}[2]$, the infinitesimal version of the moduli space of 2-form connections. This is the infinitesimal approximation to the WZW construction in 3.9.12.

Remark 5.6.33. By AdS₇/CFT₆ duality and by [Wi97b] the M5-brane is supposed to be the 6-dimensional WZW model which is holographically related to the 7-dimensional Chern-Simons term inside 11-dimensional supergravity compactified on a 4-sphere in analogy to how the traditional 2d WZW model is the holographic dual of ordinary 3d Chern-Simons theory. By our discussion here that 7d Chern-Simons theory ought to be the one given by the 7-cocycle. Indeed, we observe that this 7-cocycle does appear in the compactification according to D'Auria-Fre [dAFr82]. Back in that article these authors worked locally and discarded precisely this term as a global derivative, but in fact it is a topological term as befits a Chern-Simons term and may *not* be discarded globally. This connects the discussion here to the holographic AdS₇/CFT₆-description of the *single* M5-brane. Now a coincident N -tuple of M5-branes is supposed to be determined by a semisimple Lie algebra and nonabelian higher gauge field data. Since AdS₇/CFT₆ is still supposed to apply, we are to consider the *nonabelian* contributions to the 7-dimensional Chern-Simons term in 11d sugra compactified to AdS₇. These follow from the 11-dimensional anomaly cancellation and charge quantization. Putting this together as discussed in 5.5.9 yields the corresponding 7d Chern-Simons theory. Among other terms it is controlled by the canonical 7-cocycle $\mu_7^{\mathfrak{so}}$ on the semisimple Lie algebra \mathfrak{so} . Since this extends evidently to a cocycle also on the super Poincaré Lie algebra, we may just add it to the bispinorial cocycle that defines the single M5, to get

$$\mathbb{R}^{11;N=1} \times \mathfrak{so}(10, 1) \xrightarrow{\bar{\psi}e^5\psi + \langle \omega \wedge [\omega \wedge \omega] \wedge [\omega \wedge \omega] \wedge [\omega \wedge \omega] \rangle} \mathbb{R}[6] .$$

By the general theory indicated here this defines a 6-dimensional WZW model. By the discussion in 5.5.9 and 5.2.9 it satisfies all the conditions imposed by holography. It is to be expected that this is part of the description of the nonabelian M5-brane.

Finally it is interesting to consider the symmetries of the M5-brane higher WZW model obtained this way.

Definition 5.6.34. The *polyvector extension* [ACDP03] of $\mathfrak{sl}(10,1)$ – called the *M-theory Lie algebra* [Sez96] – is the super Lie algebra obtained by adjoining to $\mathfrak{sl}(10,1)$ generators $\{Q_\alpha, Z^{ab}\}$ that transform as spinors with respect to the existing generators, and whose non-vanishing brackets among themselves are

$$\begin{aligned} [Q_\alpha, Q_\beta] &= i(C\Gamma^a)_{\alpha\beta} P_a + (C\Gamma_{ab}) Z^{ab}, \\ [Q_\alpha, Z^{ab}] &= 2i(C\Gamma^{[a})_{\alpha\beta} Q^{b]\beta}. \end{aligned}$$

Proposition 5.6.35. *The degree-0 piece of the graded Lie algebra of infinitesimal automorphisms of m2brane, Def. 5.6.12, is the “M-theory algebra” polyvector extension of the 11d super Poincaré algebra of Def. 5.6.34.*

Proof. We leave this as an exercise to the reader. Hint: under the identification of FDA-language with ingredients of L_∞ -homotopy theory as discussed here, one can see that this involves the computations displayed in [Ca95]. \square

5.6.4.5 The complete brane bouquet of string/M-theory We have discussed various higher super Lie n -algebras of super-spacetime. Here we now sum up, list all the relevant extensions and fit them into the full brane bouquet. To state the brane bouquet, we first need names for all the branches that it has

Definition 5.6.36. The *refined brane scan* is the following collection of values of triples (d, p, N) .

D	$p = 0$	1	2	3	4	5	6	7	8	9
11			(1) m2brane			(1) m5brane				
10	(1,1) $\mathcal{D}0$ brane	(1,0) string _{het} (1,1) string _{IIA} (2,0) string _{IIB} (2,0) $\mathcal{D}1$ brane	(1,1) $\mathcal{D}2$ brane	(2,0) $\mathcal{D}3$ brane	(1,1) $\mathcal{D}4$ brane	(1,0) ns5brane _{het} (1,1) ns5brane _{IIA} (2,0) ns5brane _{IIB} (2,0) $\mathcal{D}5$ brane	(1,1) $\mathcal{D}6$ brane	(2,0) $\mathcal{D}7$ brane	(1,1) $\mathcal{D}8$ brane	(2,0) $\mathcal{D}9$ brane
9					(1)					
8				(1)						
7			(1)							
6		(2,0) sDstring		(2,0)						
5			(1)							
4		(1)	(1)							
3		(1)								

The entries of this table denote super- L_∞ -algebras that organize themselves as nodes in the brane bouquet according to the following proposition.

Proposition 5.6.37 (The brane bouquet). *There exists a system of higher super-Lie- n -algebra extensions of the super-translation Lie algebra $\mathbb{R}^{d,N}$ for $(d = 11, N = 1)$, $(d = 10, N = (1, 1))$, for $(d = 10, N = (2, 0))$*

and for $(d = 6, N = (2, 0))$, which is jointly given by the following diagram

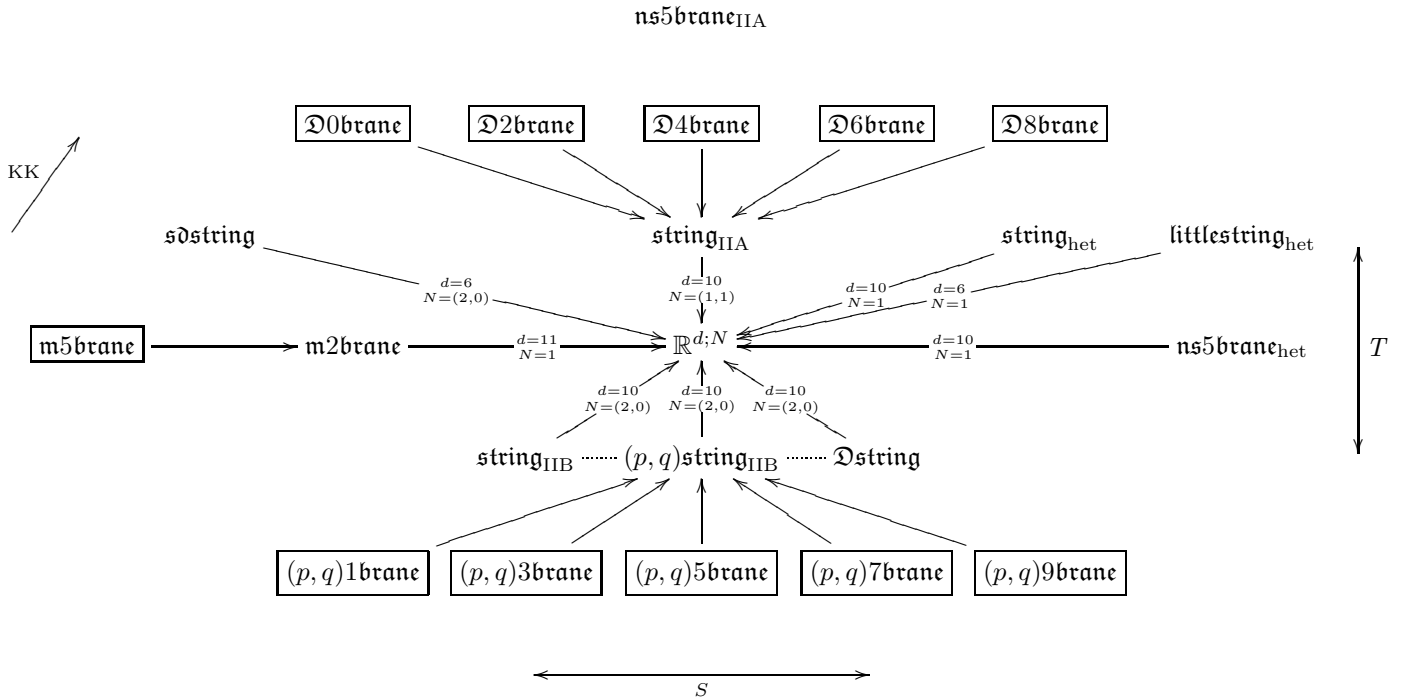

where

- An object in this diagram is precisely a super-Lie- $(p + 1)$ -algebra extension of the super translation algebra $\mathbb{R}^{d;N}$, with (d, p, N) as given by the entries of the same name in the refined brane scan, def. 5.6.36;
- every morphism is a super-Lie $(p + 1)$ -algebra extension by an exceptional \mathbb{R} -valued $\mathfrak{o}(d)$ -invariant super- L_∞ -cocycle of degree $p + 2$ on the domain of the morphism;
- the unboxed morphisms are hence super Lie $(p + 1)$ -algebra extensions of $\mathbb{R}^{d;N}$ by a super Lie algebra $(p + 2)$ -cocycle, hence are homotopy fibers of the form

$$\begin{array}{ccc}
 p\text{brane} & \longrightarrow & * \\
 \downarrow & \lrcorner & \downarrow \\
 \mathbb{R}^{d;N} & \xrightarrow{\text{some cocycle}} & \mathbb{R}[p + 1],
 \end{array}$$

- and the boxed super- L_∞ -algebras are super Lie $(p + 1)$ -algebra extensions of genuine super- L_∞ -algebras (which are not plain super Lie algebras), again by \mathbb{R} -cocycles

$$\begin{array}{ccc}
 p_2\text{brane} & \longrightarrow & * \\
 \downarrow & \lrcorner & \downarrow \\
 p_1\text{brane} & \xrightarrow{\text{some cocycle}} & \mathbb{R}[p_2 + 1].
 \end{array}$$

Proof. Using prop. 5.6.17 and the dictionary that we have established above between the language used in the physics literature (“FDA”s) and super- L_∞ -algebra homotopy theory, this is a translation of the following results that can be found scattered in the literature (some of which were discussed in the previous sections).

- All $N = 1$ -extensions of $\mathbb{R}^{d;N=1}$ are those corresponding to the “old brane scan” [AETW87]. Specifically the cocycle which classifies the super Lie 3-algebra extension $\mathbf{m2brane} \rightarrow \mathbb{R}^{11;1}$ had been found earlier in the context of supergravity around equation (3.12) of [dAFr82]. These authors also explicitly write down the “FDA” that then in [SSS09a] was recognized as the Chevalley-Eilenberg algebra of the super Lie 3-algebra $\mathbf{m2brane}$ (there called the “supergravity Lie 3-algebra”). Later all these cocycles appear in the systematic classification of super Lie algebra cohomology in [Br10a, Br10b, Br13].
- The 7-cocycle classifying the super-Lie-6-algebra extension $\mathbf{m5brane} \rightarrow \mathbf{m2brane}$ together with that extension itself can be traced back, in FDA-language, to (3.26) in [dAFr82]. This is maybe still the only previous reference that makes explicit the Lie 6-algebra extension (as an “FDA”), but the corresponding 7-cocycle itself has later been rediscovered several times, more or less explicitly. For instance it appears as equations (6) and (9) in [BLNPST97]. A systematic discussion is in section 8 of [CdAIP99].
- The extension $\mathbf{string}_{\text{IIA}} \rightarrow \mathbb{R}^{10;N=(1,1)}$ by a super Lie algebra 3-cocycle and the cocycles for the further higher extensions $\mathfrak{D}(2n)\mathbf{brane} \rightarrow \mathbf{string}_{\text{IIA}}$ can be traced back to section 6 of [CdAIP99].
- The extension $\mathbf{string}_{\text{IIB}} \rightarrow \mathbb{R}^{10;N=(2,0)}$ by a super Lie algebra 2-cocycle and the cocycles for the further higher extensions $\mathfrak{D}(2n+1)\mathbf{brane} \rightarrow \mathbf{string}_{\text{IIB}}$, as well as the extension $\mathbf{ns5brane}_{\text{IIB}} \rightarrow \mathfrak{D}\mathbf{string}$ follow from section 2 of [Sak99].

□

Remark 5.6.38. The look of the brane bouquet, Prop. 5.6.37, is reminiscent of the famous cartoon that displays the conjectured coupling limits of string/M-theory, e.g. figure 4 in [Wi98b], or fig. 1 in [Po99]. Contrary to that cartoon, the brane bouquet is a theorem. Of course that cartoon alludes to more details of the nature of string/M-theory than we are currently discussing here, but all the more should it be worthwhile to have a formalism that makes precise at least the basic structure, so as to be able to proceed from solid foundations.

5.7 Local boundary and defect prequantum field theory

We now discuss examples and applications of the general mechanism of higher local prequantum boundary and defect field theory, 3.9.14. Our main interest here is the hierarchy of boundary and defect structures relating higher Chern-Simons-type field theories to higher Wess-Zumino-Witten type field theories.

We start in section

- 5.7.1 – *Vacuum defects from spontaneous symmetry breaking*

with discussion of how the general abstract theory in Section 3.9.14 of correspondence spaces in higher homotopy types nicely captures the traditional notions in physics phenomenology of *spontaneous symmetry breaking vacuum defects* called *cosmic monopoles*, *cosmic strings* and *cosmic domain walls*, including the traditional rules by which these may end on each other. This discussion uses a minimum of mathematical sophistication (just some homotopy pullbacks) but may serve to nicely illustrate the interpretation of the abstract formalism in actual realistic physics. Readers not interested in this interpretation may want to skip this section.

Our main example here is then

- 5.7.2 – Higher Chern-Simons local prequantum field theory

where we observe that in the ∞ -topos \mathbf{H} of smooth stacks there is a canonical tower of topological higher local prequantum field theories whose cascade of higher codimension defects naturally induce higher Chern-Simons type prequantum field theories and their associated theories.

5.7.1 Vacuum defects from spontaneous symmetry breaking

In particle physics phenomenology and cosmology, there is a traditional notion of *defects in the vacuum structure* of gauge field theories which exhibit spontaneous symmetry breaking, such as in the Higgs mechanism. A review of these ideas is in [ViSh94]. A discussion of how such vacuum defects due to symmetry breaking may end on each other, and hence form a network of defects of varying codimension, is in [PrVi92]. Here we briefly review the mechanism indicated in the latter article and then show how it is neatly formalized within the general notion of defect field theories as in Section 3.9.14.6. This is intended to serve as an illustration of the physical interpretation of the abstract notion of defects in field theories and of their formalization by correspondences, particularly. Readers not interested in physics phenomenology may want to skip this section.

Consider an inclusion of topological groups $H \hookrightarrow G$. Here we are to think of G as the gauge group (more mathematically precise: structure group) of a gauge theory and of $H \hookrightarrow G$ as the subgroup that is preserved by any one of its degenerate vacua (for instance in a Higgs mechanism), hence the gauge group that remains after spontaneous symmetry breaking. In this case the quotient space (coset space) G/H is the moduli space of vacuum configurations, so that a vacuum configuration up to continuous deformations on a spacetime Σ is given by the homotopy class of a map from Σ to G/H .

Traditionally a *codimension- k defect in the vacuum structure* of a theory with such spontaneous symmetry breaking is a spacetime locally of the form $\mathbb{R}^n - (D^k \times \mathbb{R}^{n-k})$ with a vacuum classified locally by the homotopy class of a map

$$S^{k-1} \simeq \mathbb{R}^n - (D^k \times \mathbb{R}^{n-k}) \rightarrow G/H,$$

hence by an element of the $(k-1)$ -st homotopy group of G/H . If this element is non-trivial, one says that the vacuum has a *codimension- k defect*. Specifically in an $(n=4)$ -dimensional spacetime Σ

- for $k=1$ this is called a *domain wall*;
- for $k=2$ this is called a *cosmic string*;
- for $k=3$ this is called a *monopole*.

Next consider a sequence of inclusions of topological groups

$$H_2 \hookrightarrow H_1 \hookrightarrow H_0 = G.$$

Along the above lines this is now to be thought of as describing the breaking of a symmetry group $G = H_0$ first to H_1 at some energy scale E_1 , and then a further breaking down to H_2 at some lower energy scale E_2 . So at the high energy scale the moduli space of vacuum structures is $G/H_1 = H_0/H_1$ as before. But at the low energy scale the moduli space of vacuum structures is now H_1/H_2 . If there is a vacuum defect at low energy, classified by a map $S^{k-1} \rightarrow H_1/H_2$, then if it is “heated up” or rather if it “tunnels” by a quantum fluctuation through the energy barrier, it becomes instead a defect classified by a map to H_0/H_2 , namely by the composite

$$S^{k-1} \rightarrow H_1/H_2 \rightarrow H_0/H_2.$$

Here the map on the right is the fiber inclusion of the H_1 -associated H_1/H_2 -fiber bundle

$$H_1/H_2 \rightarrow H_0/H_2 \rightarrow H_0/H_1$$

naturally induced by the sequence of broken symmetry groups. The heated defect may be unstable, hence given by a trivial element in the $(k - 1)$ -st homotopy group of H_0/H_2 , even if the former is not, in which case one says that the original defect is *metastable*. In terms of diagrams, metastability of the low energy defect means precisely that its classifying map $S^{k-1} \rightarrow H_1/H_2$ extends to a homotopy commutative diagram of the form

$$\begin{array}{ccc} S^{k-1} & \longrightarrow & H_1/H_2 \\ \downarrow & & \downarrow \\ D^k & \longrightarrow & H_0/H_2 \end{array} ,$$

where the left vertical arrow is the boundary inclusion $S^{k-1} \hookrightarrow D^k$. Now according to [PrVi92], the decay of a metastable low-energy vacuum defect of codimension- k leads to the formation of a stable high-energy defect of codimension- $(k + 1)$ at its decaying boundary. For instance a metastable cosmic string defect in the low energy vacuum structure is supposed to be able to end (decay) on a cosmic monopole defect in the high energy vacuum structure.

We now turn to a formalization of this story. By Def. 3.9.137, the discussion in [PrVi92] shows that the transition from metastable codimension- k defects in the low energy vacuum structure to stable high-energy $(k + 1)$ -defects should be represented by a correspondence of the form

$$[\Pi(S^{k-1}), \Pi(H_1/H_2)] \longleftarrow [\Pi(S^k), \Pi(H_0/H_1)] \longrightarrow * ,$$

exhibiting the high energy defects as boundary data for the low energy defects.

To see how to obtain this in line with the phenomenological story, observe that the heating/tunneling process as well as the decay process of the heated defects are naturally represented by the maps on the left and the right of the following diagram, respectively:

$$\begin{array}{ccc} & & * \\ & & \swarrow D^k \rightarrow H_0/H_2 \\ [\Pi(S^{k-1}), \Pi(H_1/H_2)] & & [\Pi(D^k), \Pi(H_0/H_2)] \\ \searrow H_1/H_2 \rightarrow H_0/H_2 & & \swarrow S^{k-1} \hookrightarrow D^k \\ & & [\Pi(S^{k-1}), \Pi(H_0/H_2)] \end{array}$$

The left map sends a low energy defect to its high energy version, the right map sends a high energy decay process to the field configuration which is decaying. For a specific spatially localized defect process $D^k \rightarrow H_0/H_2$ we are to pick one point in the space of defect processes, which is what the top right map reflects. Therefore, the moduli space of decay processes of metastable low energy defects is precisely the homotopy fiber product of these two maps, namely the space of pairs consisting of a low energy defect and a localized decay process of its heated version (up to a pertinent gauge transformation that identifies the heated defect with the field configuration which decays). By the above fiber sequence of quotient spaces one finds that this homotopy pullback is $[\Pi(S^{k-1}), \Omega\Pi(H_0/H_1)]$. Hence, in conclusion, we find the desired

correspondence as the top part of the following homotopy pullback diagram

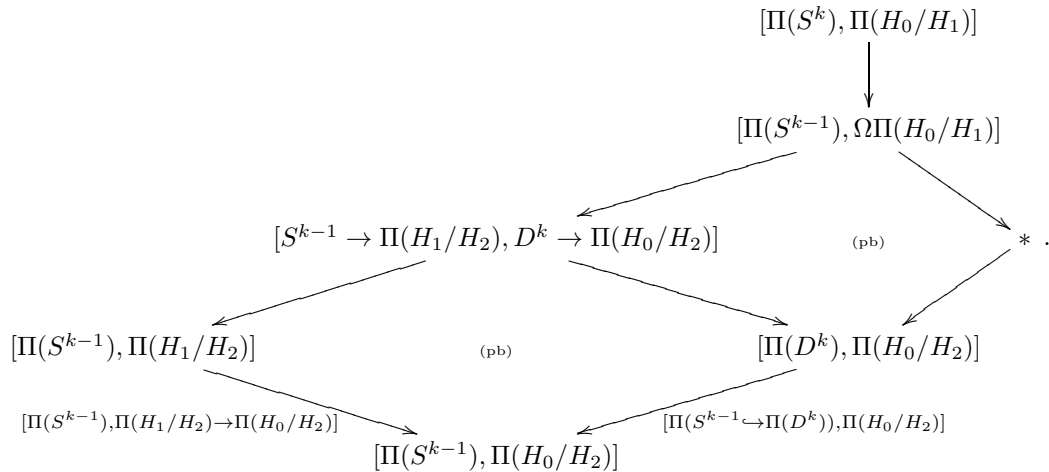

In summary, this diagram encodes the phenomenological story of the decay of metastable defects as follows:

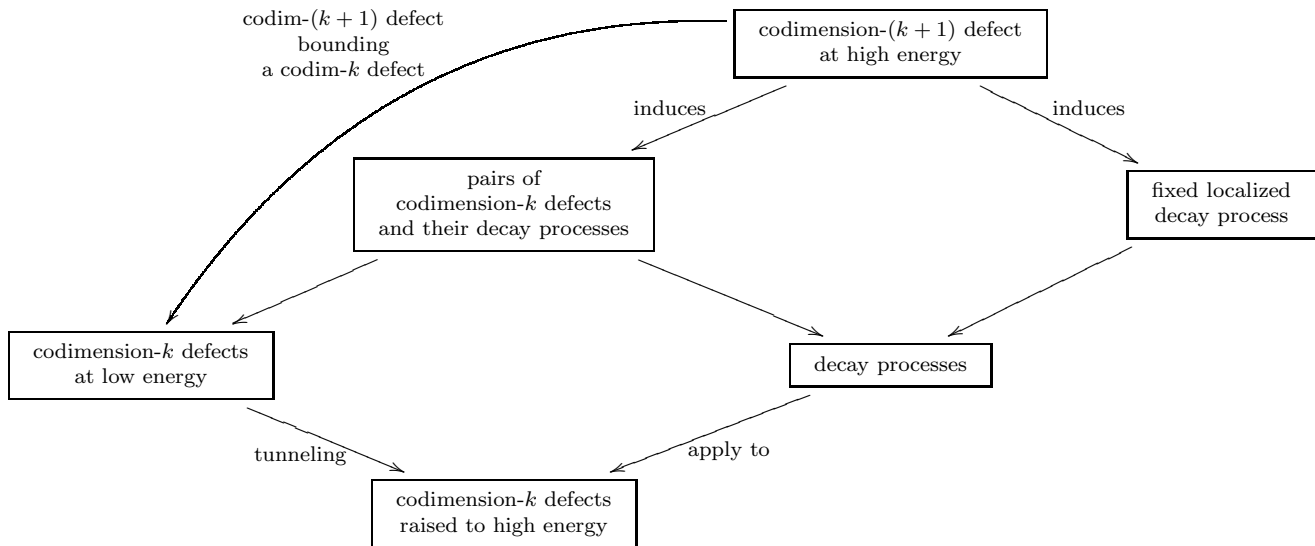

5.7.2 Higher Chern-Simons local prequantum boundary field theory

We now turn to the class of those local prequantum field theories which deserve to be termed of *Chern-Simons type*. We show that these arise rather canonically as the boundary data for the canonical differential cohomological structure of Prop. 5.7.1 which is exhibited by every cohesive ∞ -topos \mathbf{H} .

5.7.2.1 Survey: towers of boundaries, corners, ... and of circle reductions We discuss in the following towers/hierarchies of iterated defects of increasing codimension of a universal topological Yang-Mills theory. Most of these defects, however, are best recognized after “gluing their endpoints” after which they equivalently become circle-reductions/transgression to loop space of the original theory. Restricted to the archetypical case of 3d Chern-Simons theory, the following discussion essentially goes through the

following diagram:

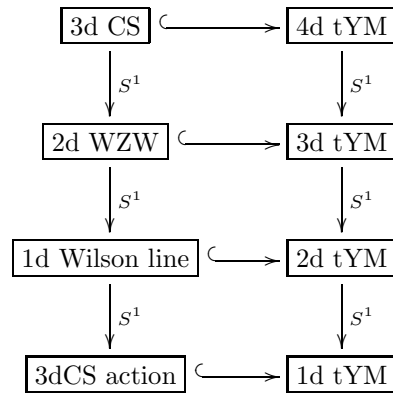

This is a pattern of iterated higher codimension corners and iterated circle reductions which had long been emphasized by Hisham Sati to govern the grand structure of hierarchies of theories inside string/M-theory [Sa10, Sa11a, Sa12]. For instance there should be a tower of this kind which instead of 3d Chern-Simons theory has 11-dimensional supergravity, or “M-theory” as follows:

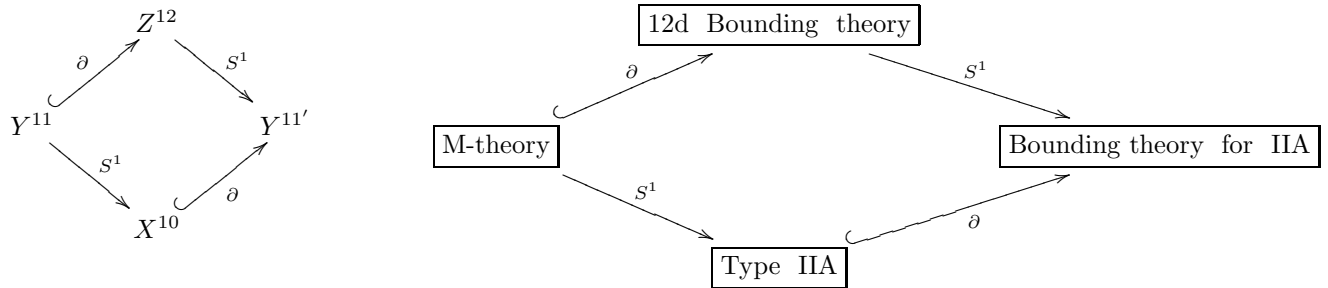

From this descent further such towers in string/M-theory, and for each one can have various extensions deeper in dimensions, via both dimensional reductions and boundaries. For instance, Edward Witten has

been exploring a system of reductions [Wi11] which in (small) parts involves a system roughly as follows

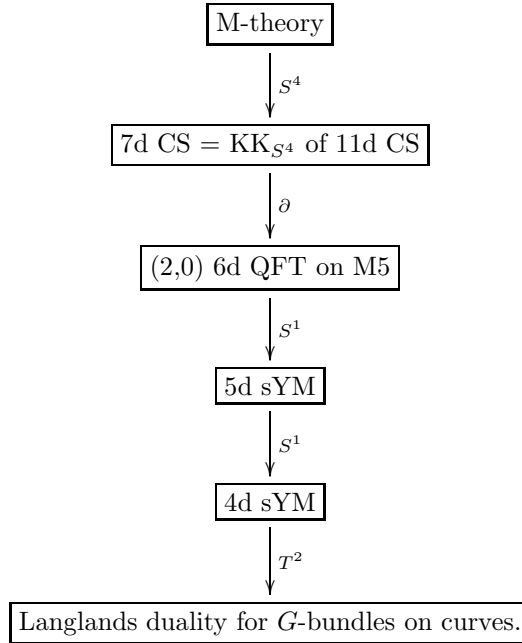

The second entry from the top indicates the 7-dimensional Chern-Simons theory/term arising from the Kaluza-Klein reduction on the 4-sphere of the corresponding term in eleven dimensions [FSS12b], this we discuss below in 5.5.9.3. The next is the 6-dimensional boundary field theory of this, whose Green-Schwarz contribution we discuss in 5.6.4.

5.7.2.2 $d = n + 1$: Universal topological Yang-Mills theory We consider a simple theory where fields are closed differential forms and the Lagrangian being the integral of that form. We start with the abelian but higher case and later we get nonabelian theories by introducing boundaries.

First recall from the following system of higher differential moduli stacks.

Proposition 5.7.1. *For $n \in \mathbb{N}$ we have a pasting diagram of homotopy pullback squares in $\mathbf{H} = \text{Smooth}\infty\text{Grpd}$ of the form*

$$\begin{array}{ccccc}
 \mathbf{B}^n U(1)_{\text{conn}} & \xrightarrow[\text{connection}]{\text{forget (non-flat)}} & \mathbf{B}^n U(1) & \longrightarrow & * \\
 \text{curv} \downarrow & & \downarrow & & \downarrow \\
 \Omega_{\text{cl}}^{n+1} & \xrightarrow{\text{inclusion}} & \mathfrak{b}_{\text{dR}} \mathbf{B}^{n+1} U(1) & \xrightarrow{FA} & \mathfrak{b} \mathbf{B}^{n+1} U(1) \\
 & & \downarrow & & \downarrow \text{forget flat connection} \\
 & & * & \longrightarrow & \mathbf{B}^{n+1} U(1)
 \end{array} ,$$

where FA is the map that takes a flat curvature form and interprets it as a connection on the trivial bundle of one higher degree.

As a special case of Prop. 3.9.118 we have:

Proposition 5.7.2. *For $n \in \mathbb{N}$, the morphism*

$$\exp(iS_{\text{tYM}}): \Omega_{\text{cl}}^{n+1} \longrightarrow \mathfrak{b} \mathbf{B}^{n+1} U(1)$$

in prop. 5.7.1, regarded as an object

$$\left[\begin{array}{c} \Omega_{\text{cl}}^{n+1} \\ \downarrow \exp\left(\frac{i}{\hbar} S_{\text{tYM}}\right) \\ \mathbf{b}\mathbf{B}^{n+1}U(1) \end{array} \right] \in \text{Corr}_n(\mathbf{H}/\mathbf{b}\mathbf{B}^nU(1))^{\otimes},$$

is fully dualizable, with dual $\exp\left(-\frac{i}{\hbar} S_{\text{tYM}}\right)$.

Definition 5.7.3. For $n \in \mathbb{N}$, we call the local prequantum field theory defined by the fully dualizable object S_{tYM} of Prop. 5.7.2 the *universal topological Yang-Mills local prequantum field theory*

$$\exp\left(\frac{i}{\hbar} S_{\text{tYM}}\right) : \text{Bord}_{n+1}^{\otimes} \rightarrow \text{Corr}_{n+1}(\mathbf{H}/\mathbf{b}\mathbf{B}^{n+1}U(1))^{\otimes}.$$

This terminology is justified below in Remark 5.7.7. We will encounter this theory again in later sections.

5.7.2.3 $d = n + 0$: Higher Chern-Simons field theories We discuss now the boundary conditions of the universal topological Yang-Mills local prequantum field theory

Remark 5.7.4. The universal boundary condition for S_{tYM} according to Def. 3.9.132 is given by the top rectangle in Prop. 5.7.1, naturally regarded as a correspondence in the slice:

$$\begin{array}{ccc} \mathbf{B}^nU(1)_{\text{conn}} & & \Omega_{\text{cl}}^{n+1} \\ \swarrow & \xrightarrow{F(-)} & \searrow \\ * & & \Omega_{\text{cl}}^{n+1} \\ \searrow & \xrightarrow{\exp\left(\frac{i}{\hbar} S_{\text{tYM}}\right)} & \swarrow \\ \mathbf{b}\mathbf{B}^{n+1}U(1) & & * \end{array}.$$

So by Prop. 3.9.133 there is a natural equivalence of ∞ -categories

$$\text{Bdr}\left(\exp\left(\frac{i}{\hbar} S_{\text{tYM}}\right)\right) \simeq \mathbf{H}/\mathbf{B}^nU(1)_{\text{conn}}$$

between the ∞ -category of boundary conditions for the universal topological Yang-Mills theory in dimension $(n + 1)$ and the slice ∞ -topos of \mathbf{H} over the moduli stack of $U(1)$ - n -connections.

Corollary 5.7.5. *The $(\infty, 1)$ -category of boundary conditions for the universal topological Yang-Mills local prequantum field theory S_{tYM} are equivalently ∞ -Chern-Simons local prequantum field theories [FSS13a]: moduli stacks $\mathbf{Fields}_{\partial} \in \mathbf{H}$ equipped with a prequantum n -bundle [FRS13a]*

$$\nabla_{\text{CS}} : \mathbf{Fields}_{\partial} \rightarrow \mathbf{B}^nU(1)_{\text{conn}}.$$

The automorphism ∞ -group of a given boundary condition for S_{tYM} is hence equivalently the quantomorphism ∞ -group of the corresponding Chern-Simons theory [FRS13a].

Proof. This is just a special case of Prop. 3.9.133. Explicitly, by the universal property of the homotopy pullback in \mathbf{H} , given any boundary condition for S_{tYM} , hence by Remark 3.9.130 a diagram in \mathbf{H} of the form

$$\begin{array}{ccc} \mathbf{Fields}_{\partial} & & \Omega_{\text{cl}}^{n+1} \\ \swarrow & \xrightarrow{\langle F(-) \wedge \cdots \wedge F(-) \rangle} & \searrow \\ * & & \Omega_{\text{cl}}^{n+1} \\ \searrow & \xrightarrow{\exp\left(\frac{i}{\hbar} S_{\text{tYM}}\right)} & \swarrow \\ \mathbf{b}\mathbf{B}^{n+1}U(1) & & * \end{array},$$

∇

this is equivalent to the dashed morphism in the diagram

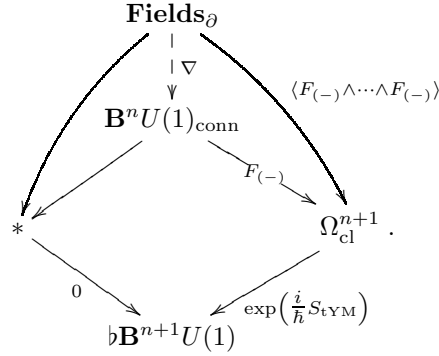

□

Remark 5.7.6. Observe that while the space of phases of the bulk field theory is $\mathfrak{b}\mathbf{B}^{n+1}U(1)$, we may now regard $\mathbf{B}^n U(1)_{\text{conn}}$ as the space of spaces of the boundary field theory.

In order to interpret this, notice the following.

Remark 5.7.7. For the special case that $\mathbf{Fields}_{\partial}$ is a moduli stack $\mathbf{B}G_{\text{conn}}$ of G -principal ∞ -connections for some ∞ -group G , we may think of the morphism

$$\langle F_{(-)} \wedge \dots \wedge F_{(-)} \rangle : \mathbf{B}G_{\text{conn}} \rightarrow \Omega_{\text{cl}}^{n+1}$$

as encoding an *invariant polynomial* $\langle -, \dots, - \rangle$ on (the ∞ -Lie algebra of) G [FSS10]. By extrapolation from this case we may also speak of invariant polynomials if $\mathbf{Fields}_{\partial\Sigma}$ is of more general form, in which case we have invariant polynomials on *smooth ∞ -groupoids*. Restricting to the group-al case just for definiteness, notice that a boundary field configuration, which by Prop. 3.9.127 is given by

$$\begin{array}{ccc} \partial\Sigma \times U & \xrightarrow{\nabla} & \mathbf{B}G_{\text{conn}} \\ \downarrow & & \downarrow \\ \Sigma \times U & \xrightarrow{\omega} & \Omega_{\text{cl}}^{n+1} \end{array} ,$$

forces the closed $(n + 1)$ -form ω of the bulk theory to become the ∞ -Chern-Weil form of a G -principal ∞ -connection with respect to the invariant polynomial $\langle -, \dots, - \rangle$ at the boundary:

$$\omega|_{\partial\Sigma} = \langle F_{\nabla} \wedge \dots \wedge F_{\nabla} \rangle .$$

For G an ordinary Lie group, this is known as the *Lagrangian for topological G -Yang-Mills theory*. More generally, for G any smooth ∞ -group, we may hence think of this as the Lagrangian of a topological ∞ -Yang-Mills theory.

Specifically for the *universal* boundary condition $\mathbf{Fields}_{\partial} = \mathbf{B}^n U(1)_{\text{conn}}$ of Remark 5.7.4 we find a field theory which assigns $U(1)$ - n -connections ∇ to n -dimensional manifolds Σ_n and closed $(n + 1)$ -forms ω on $(n + 1)$ -dimensional manifolds Σ_{n+1} , such that whenever the latter bounds the former, the exponentiated integral of ω equals the *n -volume holonomy* of ∇ . This is just the relation between circle n -connections and their curvatures which is captured by the axioms of *Cheeger-Simons differential characters*. Hence it makes sense to call the higher topological Yang-Mills theory which is induced from the universal boundary condition the *Cheeger-Simons theory* in the given dimension.

However, Corollary 5.7.5 says more: the universality of the Cheeger-Simons theory as a boundary condition for topological Yang-Mills theory means that a consistent such boundary condition is necessarily not just an invariant polynomial, but is a lift of that from de Rham cocycles to differential cohomology. This means that it is a *refined* ∞ -Chern-Weil homomorphism in the sense of [FSS10] of the invariant polynomial in the sense of [FRS13a]. Equivalently it is a *higher prequantum field theory*. In either case a lift ∇ in the diagram

$$\begin{array}{ccc} & & \mathbf{B}^n U(1)_{\text{conn}} \\ & \nearrow \nabla & \downarrow \\ \mathbf{B}G_{\text{conn}} & \xrightarrow{\langle F_{(-)} \wedge \cdots \wedge F_{(-)} \rangle} & \Omega_{\text{cl}}^{n+1} . \end{array}$$

Example 5.7.8. For the canonical binary invariant polynomial $\langle -, - \rangle$ on a simply connected semisimple Lie group G such as Spin or SU (the *Killing form*) a consistent boundary condition, as in Remark 5.7.7, is provided by the differential refinement of the first fractional Pontrjagin class $\frac{1}{2}p_1$ and of the second Chern class c_2 , respectively, that have been constructed in [FSS10]:

$$\begin{array}{ccc} & & \mathbf{B}^3 U(1)_{\text{conn}} \\ & \nearrow \frac{1}{2}\widehat{p}_1 & \downarrow \\ \mathbf{B}\text{Spin}_{\text{conn}} & \xrightarrow{\langle F_{(-)} \wedge F_{(-)} \rangle} & \Omega_{\text{cl}}^4 , \end{array} \qquad \begin{array}{ccc} & & \mathbf{B}^3 U(1)_{\text{conn}} \\ & \nearrow \widehat{c}_2 & \downarrow \\ \mathbf{B}\text{SU}_{\text{conn}} & \xrightarrow{\langle F_{(-)} \wedge F_{(-)} \rangle} & \Omega_{\text{cl}}^4 . \end{array}$$

Furthermore, for the canonical quaternary invariant polynomial on the smooth String-2-group (see appendix of [FSS12b] for a review) a consistent boundary condition as in Remark 5.7.7 is provided by the differential refinement of the second fractional Pontrjagin class $\frac{1}{6}p_2$ that has also been constructed in [FSS10]:

$$\begin{array}{ccc} & & \mathbf{B}^7 U(1)_{\text{conn}} \\ & \nearrow \frac{1}{6}\widehat{p}_2 & \downarrow \\ \mathbf{B}\text{String}_{\text{conn}} & \xrightarrow{\langle F_{(-)} \wedge F_{(-)} \wedge F_{(-)} \wedge F_{(-)} \rangle} & \Omega_{\text{cl}}^8 . \end{array}$$

This describes a 7-dimensional Chern-Simons theory of nonabelian 2-form connections [FSS12b].

5.7.2.4 $d = n - 1$: Topological Chern-Simons boundaries We now consider codimension-2 corners of the universal topological Yang-Mills theory, hence codimension-1 boundaries of higher Chern-Simons theories. These turn out to be related to Wess-Zumino-Witten like theories. Further below in Section 5.6 we discuss that a natural differential variant of this type of theories also arises as ∞ -Chern-Simons theories themselves.

For characterizing the data assigned by a field theory to such corners, we will need to consider the generalization of the following traditional situation.

Example 5.7.9. For (X, ω) a symplectic manifold, $\omega \in \Omega_{\text{cl}}^2(X)$, a submanifold $Y \rightarrow X$ is *isotropic* if $\omega|_Y = 0$, and *Lagrangian* if in addition $\dim(X) = 2\dim(Y)$. If (X, ω) is equipped with a *prequantum bundle*, namely a lift ∇ in

$$\begin{array}{ccc} & & \mathbf{B}U(1)_{\text{conn}} \\ & \nearrow \nabla & \downarrow F_{(-)} \\ X & \xrightarrow{\omega} & \Omega_{\text{cl}}^2 , \end{array}$$

then we may ask not only for a trivialization of the symplectic form ω but even of the connection ∇ on Y : $\nabla|_Y \simeq 0$. If this exists, then traditionally Y is called a *Bohr-Sommerfeld leaf* of (X, ∇) , at least when Y is one leaf of a foliation of X by Lagrangian submanifolds.

Hence we set generally:

Definition 5.7.10. Given a space $X \in \mathbf{H}$ and a connection $\nabla : X \rightarrow \mathbf{B}^n U(1)_{\text{conn}}$, a *Bohr-Sommerfeld isotropic space* of (X, ∇) is a diagram of the form

$$\begin{array}{ccc} Y & \longrightarrow & 0 \\ \downarrow & \searrow & \downarrow \\ X & \xrightarrow{\nabla} & \mathbf{B}^n U(1)_{\text{conn}} \end{array}$$

in \mathbf{H} .

Remark 5.7.11. The *universal* Bohr-Sommerfeld isotropic space over (X, ∇) is the homotopy fiber $\text{fib}(\nabla) \rightarrow X$ of ∇ . In a sense this is the “maximal” Bohr-Sommerfeld isotropic space over (X, ∇) , as every other one factors through this, essentially uniquely. Below we see that these are equivalently the universal codimension-2 corners of higher Chern-Simons theory. While the property of being “isotropic and maximally so” is reminiscent of Lagrangian submanifolds, it seems unclear what the notion of Lagrangian submanifold should refine to generally in higher prequantum geometry, if anything.

Proposition 5.7.12. A corner, Def. 3.9.134, for the universal topological Yang-Mills theory, Def. 5.7.3, from a non-trivial to a trivial boundary condition, hence a boundary condition for an ∞ -Chern-Simons theory, Corollary 3.9.113, $\nabla : \mathbf{Fields}_{\partial} \rightarrow \mathbf{B}^n U(1)_{\text{conn}}$, is equivalently a Bohr-Sommerfeld isotropic space of boundary fields, Def. 5.7.10, namely a map

$$\mathbf{Fields}_{\partial\partial} \rightarrow \mathbf{Fields}_{\partial}$$

such that $F_{\nabla|_{\partial^2}} = 0$ and equipped with a homotopy $\nabla|_{\mathbf{Fields}_{\partial\partial}} \simeq 0$.

Proof. The boundary condition for ∇ is a correspondence-of-correspondences from

$$\begin{array}{ccc} & \mathbf{Fields}_{\partial} & \\ \swarrow & & \searrow \\ * & & \Omega_{\text{cl}}^{n+1} \\ \searrow & \swarrow \nabla & \swarrow \exp\left(\frac{i}{\hbar} S_{\text{tYM}}\right) \\ 0 & & \mathbf{bB}^{n+1}U(1) \end{array}$$

to

$$\begin{array}{ccc} & * & \\ \swarrow & & \searrow \\ * & & \Omega_{\text{cl}}^{n+1} \\ \searrow & \swarrow 0 & \swarrow \exp\left(\frac{i}{\hbar} S_{\text{tYM}}\right) \\ 0 & & \mathbf{bB}^{n+1}U(1) \end{array}$$

The tip of this correspondence-of-correspondences is a correspondence of the form

$$\begin{array}{ccc} & \mathbf{Fields}_{\partial\partial} & \\ \swarrow & & \searrow \\ * & & \mathbf{Fields}_{\partial} \end{array}$$

hence is just a map as on the right. The correspondence-of-correspondences is then filled with a second order homotopy between ∇ , regarded as a homotopy, and the 0-homotopy. Unwinding what this means in view of def. 4.4.88, one sees that this homotopy is given by a Čech-Deligne cochain $(\cdots, A^{\nabla_{\text{bdr}}}, 0, 0)$ such that

$$D(\cdots, A^{\nabla_{\text{bdr}}}, 0, 0) = (\cdots, A^{\nabla}, 0)|_{\partial\partial},$$

where

$$D(\cdots, A^{\nabla}, 0) = (0, 0, \cdots, 0, \omega)|_{\partial}.$$

□

Example 5.7.13 (Topological boundary for 3d Chern-Simons theory). This is in accord with what is proposed as the data on codimension-1 defects for ordinary Chern-Simons theory on p. 11 of [KaSa10a]. They propose (somewhat implicitly in their text) that the boundary connection should be such that U -component of $\langle F_{\nabla} \wedge F_{\nabla} \rangle$ vanishes at each point of Σ . But for us the fields are $A : \Pi(\Sigma) \times U \rightarrow \mathbf{BG}_{\text{conn}}$, hence are flat along Σ , hence that component vanishes anyway. As a result, the proposal in [KaSa10a] essentially comes down to asking that boundary fields ∇ are the maximal solution to trivializing $\langle F_{\nabla} \wedge F_{\nabla} \rangle$. If we refine this statement from de Rham cocycles to differential cohomology, we arrive at the above picture.

Remark 5.7.14. Chern-Simons theory is famously related to Wess-Zumino-Witten theory in codimension-1. However, WZW theory is not directly a “topological boundary” of Chern-Simons theory. Below in Section 5.7.2.6 we show that (the topological sector of) pre-quantum WZW theory is a codimension-1 *defect* from $\exp(iS_{\text{CS}})$ to itself, via $\exp(iS_{\text{tYM}})$.

Remark 5.7.15. So the *universal* boundary condition for ∞ -Chern-Simons local prequantum field theory $\nabla : \mathbf{Fields} \rightarrow \mathbf{B}^n U(1)_{\text{conn}}$ (regarded itself as a boundary condition for its topological Yang-Mills theory) is the homotopy fiber of ∇ .

Example 5.7.16. Let \mathfrak{P} be Poisson Lie algebroid and $\nabla : \tau_1 \exp(\mathfrak{P}) \rightarrow \mathbf{B}^2(\mathbb{R}/\Gamma)_{\text{conn}}$ the prequantum 2-bundle of the corresponding 2d Poisson-Chern-Simons prequantum field theory. A maximally isotropic sub-Lie algebroid $\mathfrak{C} \hookrightarrow \mathfrak{P}$ is identified in [CaFe03] with a D-brane for the theory. See [FRS13a] (...)

Further developing Example 5.7.8, we have by [FSS10] the following.

Example 5.7.17. The universal boundary condition for ordinary Spin Chern-Simons theory regarded as a local prequantum field theory $\frac{1}{2}\widehat{\mathfrak{p}}_1 : \mathbf{BSpin}_{\text{conn}} \rightarrow \mathbf{B}^3 U(1)_{\text{conn}}$ is the moduli stack of String-2-connections

$$\mathbf{BString}_{\text{conn}} \longrightarrow \mathbf{BSpin}_{\text{conn}} \xrightarrow{\frac{1}{2}\widehat{\mathfrak{p}}_1} \mathbf{B}^3 U(1)_{\text{conn}} .$$

The universal boundary condition for 7-dimensional String-Chern-Simons local prequantum field theory [FSS12b] $\frac{1}{6}\widehat{\mathfrak{p}}_2 : \mathbf{BString}_{\text{conn}} \rightarrow \mathbf{B}^7 U(1)_{\text{conn}}$ is the moduli stack of Fivebrane-6-connections

$$\mathbf{BFivebrane}_{\text{conn}} \longrightarrow \mathbf{BString}_{\text{conn}} \xrightarrow{\frac{1}{6}\widehat{\mathfrak{p}}_2} \mathbf{B}^7 U(1)_{\text{conn}} .$$

Examples 5.7.18. A rich variant of this class of examples of topological prequantum boundary conditions turns out to be the intersection laws of Green-Schwarz type super p -branes. We discuss this in details in Section 5.6.4 below.

5.7.2.5 $d = n - k$: Holonomy defects The higher parallel transport of an n -connection over a k -dimensional manifold with boundary takes values in sections of the transgression of the n -bundle to an $(n - k + 1)$ -bundle over the boundary. Here we discuss this construction at the level of moduli stacks and then observe that it is naturally interpreted in terms of defects for higher topological Yang-Mills/higher

Chern-Simons theory. The Wess-Zumino-Witten defects and the Wilson line/surface defects in the following sections 5.7.2.6 and 5.7.2.7 build on this class of examples.

First observe that a particularly simple boundary condition for topological Yang-Mills theory is to take the connection to be trivial on the boundary via the following

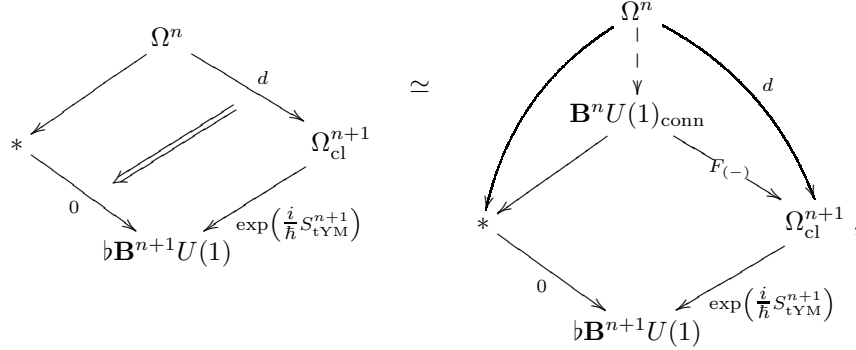

which corresponds to the inclusion

$$\Omega^n \hookrightarrow \mathbf{B}^n(1)_{\text{conn}}$$

of globally defined differential n -forms regarded as connections on trivial n -bundles.

5.7.2.6 $d = n - 1$: Wess-Zumino-Witten field theories We now consider codimension-1 defects for higher Chern-Simons theories, hence codimension-2 corners for topological Yang-Mills theory.

Remark 5.7.19. In [FuRuSc] 2-dimensional (rational) conformal field theories (CFTs) of WZW type have been constructed and classified by assigning to a punctured marked surface Σ a CFT n -point function which is induced by applying the Reshetikhin-Turaev 3d TQFT functor (hence local quantum Chern-Simons theory) to a 3-d cobordism cobounding the “double” of the marked surface. In the case that Σ is orientable and without boundary, this is the 3d cylinder $\Sigma \times [-1, 1]$ over Σ . In the language of extended QFTs with defects this construction of a 2d theory from a 3d theory may be formulated as a realization of 2d WZW theory as a codimension-1 defect in 3d Chern-Simons theory. The two chiral halves of the WZW theory correspond to the two “phases” of the 3d theory which are separated by the defect Σ . This perspective of [FuRuSc] has later been amplified in [KaSa10b].

Now let

$$\exp(iS_{\text{CS}}) = \mathbf{c} : \mathbf{B}G_{\text{conn}} \rightarrow \mathbf{B}^3U(1)_{\text{conn}}$$

be a Chern-Simons prequantum field theory. We have a G -principal bundle with connection (P, ∇) over the 1-disk D^1 , i.e the interval, whose boundary is the 0-sphere, i.e. composed of two points, schematically indicated in the following diagram

$$\begin{array}{ccccc} (P|_{\partial}, \nabla|_{\partial}) & \longrightarrow & (P, \nabla) & & \\ \downarrow & & \downarrow & & \\ * \coprod * & \xrightarrow{\partial} & D^1 & \xrightarrow{\nabla} & \mathbf{B}G_{\text{conn}} \xrightarrow{\mathbf{c}} \mathbf{B}^3U(1)_{\text{conn}} \end{array}$$

Definition 5.7.20. The *Wess-Zumino-Witten defect* is the morphism

$$\exp\left(\frac{i}{\hbar} S_{\text{CS}} \circ p_1 - iS_{\text{CS}} \circ p_2\right) \longrightarrow \exp\left(\frac{i}{\hbar} S_{\text{tYM}}\right)$$

in $\text{Corr}(\mathbf{H}/\mathbf{B}^3U(1)_{\text{conn}})$ given in \mathbf{H} by the the transgression, Def. 4.4.132, of the Chern-Simons connection over the 1-disk

$$\begin{array}{ccc}
 & [D^1, \mathbf{BG}_{\text{conn}}] & \\
 \swarrow (-)|_{\partial D^1} & & \searrow \\
 [S^0, \mathbf{BG}_{\text{conn}}] \simeq \mathbf{BG}_{\text{conn}} \times \mathbf{BG}_{\text{conn}} & \xrightarrow{\exp\left(\frac{i}{\hbar} \int_{D^1} [D^1, \mathbf{c}]\right)} & \Omega_{\text{cl}}^3 \\
 \searrow \text{cop}_1 - \text{cop}_2 & & \swarrow \\
 & \mathbf{B}^3U(1)_{\text{conn}} &
 \end{array}$$

Remark 5.7.21. This is a codimension-1 defect of S^3_{tYM} according to Def. 3.9.137. It may be visualized as a 1-dimensional “cap”

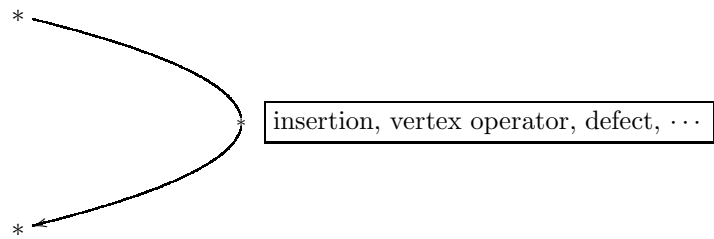

for a single copy of the CS-theory, whose 0-dimensional tip carries a tYM-theory. Here a closed 3-form is what is responsible for the defect, hence the name “defect field”. By duality we may straighten this structure and visualize it schematically as

$$\text{WZW} = \left\{ \begin{array}{l} \text{CS}^l \\ | \\ * \\ | \\ \text{CS}^r . \end{array} \right.$$

This defect becomes a plain boundary for the tYM-theory when the left end is attached to a boundary that couples the left with the right part of the CS-theory:

Definition 5.7.22. The *Wess-Zumino-Witten codimension-2* corner in 4d topological Yang-Mills theory is the boundary

$$\begin{array}{ccc}
 \mathbb{I} & \longrightarrow & \mathbb{I} \\
 \downarrow & & \downarrow \\
 \mathbb{I} & \xrightarrow{S^3_{\text{tYM}}} & S^4_{\text{tYM}}
 \end{array}$$

of the boundary 3d tYM theory given as a diagram in \mathbf{H} by the composite

$$\begin{array}{ccc}
 \begin{array}{ccc}
 G & & \\
 \downarrow \exp(iS_{\text{WZW}}) & & \\
 \mathbf{B}^2U(1)_{\text{conn}} & & \\
 \swarrow & \xrightarrow{F(-)} & \searrow \\
 * & & \Omega_{\text{cl}}^3 \\
 \downarrow 0 & \swarrow \nabla_{\text{ChS}} & \downarrow \exp\left(\frac{i}{\hbar}S_{\text{tYM}}^3\right) \\
 \mathbf{B}^3U(1)_{\text{conn}} & &
 \end{array}
 & = &
 \begin{array}{ccc}
 G & & \\
 \swarrow & & \searrow \\
 * & & [D^1, \mathbf{B}G_{\text{conn}}] \\
 \downarrow 0 & \swarrow & \downarrow (-)|_{\partial D^1} \\
 * & & [S^0, \mathbf{B}G_{\text{conn}}] \\
 \downarrow 0 & \swarrow \exp\left(\frac{i}{\hbar}\int_{D^1}(-)\right) & \downarrow \text{cop}_1 \downarrow \text{cop}_2 \\
 * & & \mathbf{B}^3U(1)_{\text{conn}} \\
 & \swarrow \exp\left(\frac{i}{\hbar}S_{\text{tYM}}^3\right) & \searrow \\
 & & \Omega_{\text{cl}}^3
 \end{array}
 \end{array}$$

Here the bottom right square is that of Def. 5.7.20, the bottom left square is filled with the evident equivalence, and the map $G \rightarrow [S^1, \mathbf{B}G_{\text{conn}}]$ in the top square is given by resolving the simply connected Lie group G by its based path space P_*G , regarded as a diffeological space. Then each path uniquely arises as the parallel transport of a G -principal connection on the interval and two paths with the same endpoint have a unique gauge transformation relating them.

Remark 5.7.23. It is important to highlight that G here is the differential concretification of the pullback in the middle, as discussed in [FRS13a].

Proposition 5.7.24. *The morphism*

$$\exp\left(\frac{i}{\hbar}S_{\text{WZW}}\right) : G \rightarrow \mathbf{B}^2U(1)_{\text{conn}}$$

from Def. 5.7.22 is the WZW-2-connection (the “WZW gerbe”/“WZW B-field”).

Proof. This follows along the lines of the discussion in [FSS13a], where it was found that the composite

$$G \longrightarrow [S^1, \mathbf{B}G_{\text{conn}}] \xrightarrow{[S^1, c]} [S^1, \mathbf{B}^3U(1)_{\text{conn}}] \xrightarrow{\exp\left(\frac{i}{\hbar}\int_{S^1}(-)\right)} \mathbf{B}^2U(1)_{\text{conn}}$$

is the (topological part of) the localized WZW action. \square

5.7.2.7 $d = n - 2$: Wilson loop/Wilson surface field theories In 1.2.15.1.5 ([FSS13a]) a description of how Wilson loop line defects in 3d Chern-Simons theory is given by the following data. Let $\lambda \in \mathfrak{g}$ be a regular weight, corresponding via Borel-Weil-Bott to the irreducible representation which labels the Wilson loop. Then the stabilizer subgroup $G_\lambda \hookrightarrow G$ of λ under the adjoint action is a maximal torus $G_\lambda \simeq T \hookrightarrow G$ and $G/G_\lambda \simeq \mathcal{O}_\lambda$ is the coadjoint orbit. Integrality of λ means that pairing with λ constitutes a morphism of moduli stacks of the form

$$S_W : \Omega^1(-, \mathfrak{g})//T \xrightarrow{\langle \lambda, - \rangle} \mathbf{B}U(1)_{\text{conn}} .$$

This is the local Lagrangian/the prequantum bundle of the Wilson loop theory in that there is a diagram

$$\begin{array}{ccccc}
 \mathcal{O}_\lambda & \xrightarrow{\text{fib}(\mathbf{J})} & \Omega^1(-, \mathfrak{g})//T & \xrightarrow{\langle \lambda, - \rangle} & \mathbf{B}U(1)_{\text{conn}} \\
 \downarrow & & \downarrow \mathbf{J} & & \\
 * & \longrightarrow & \mathbf{B}G_{\text{conn}} & \xrightarrow{c} & \mathbf{B}^3U(1)_{\text{conn}} ,
 \end{array}$$

whose top composite is the Kirillov prequantum bundle on the coadjoint orbit and which is such that a Chern-Simons + Wilson loop field configuration (A, g) is a diagram

$$\begin{array}{ccc}
 S^1 & \xrightarrow{A|_{S^1}} & \Omega^1(-, \mathfrak{g})//T \\
 \downarrow & \swarrow g & \downarrow \mathbf{J} \\
 \Sigma_3 & \xrightarrow{A} & \mathbf{BG}_{\text{conn}}
 \end{array}$$

and the corresponding action functional is the product of $\langle \lambda, - \rangle$ transgressed over S^1 and \mathbf{c} transgressed over Σ_3 .

We now interpret this formally as a codimension-2 defect of Chern-Simons theory analogous to the WZW defect, hence as a codimension-3 structure in the ambient tYM theory.

Definition 5.7.25. Let $\phi : D^2 \rightarrow S^2$ be a smooth function which on the interior of S^2 is a diffeomorphism on $S^2 - \{*\}$. The *universal Wilson line/Wilson surface defect* is, as a diagram in \mathbf{H} , the transgression diagram, Def. 4.4.132

$$\begin{array}{ccccc}
 & [S^2, \mathbf{BG}_{\text{conn}}] & & & \\
 & \swarrow & \downarrow [\phi|_{S^1}, \mathbf{BG}_{\text{conn}}] & \searrow [\phi, \mathbf{BG}_{\text{conn}}] & \\
 [\Pi(S^1), \mathbf{BG}_{\text{conn}}] & & [D^2, \mathbf{BG}_{\text{conn}}] & & \\
 & \searrow & \swarrow (-)|_{\partial D^2} & \searrow & \\
 & [S^1, \mathbf{BG}_{\text{conn}}] & \xrightarrow{\exp(\frac{i}{\hbar} \int_{D^2} [D^2, \mathbf{c}])} & \Omega_{\text{cl}}^2 & \\
 & \searrow \exp(\frac{i}{\hbar} \int_{S^1} [S^1, \mathbf{c}]) & & \swarrow & \\
 & & \mathbf{B}^2U(1)_{\text{conn}} & &
 \end{array}$$

Remark 5.7.26. This is a codimension-2 defect according to Def. 3.9.137. It may be visualized as a 2-dimensional CS theory cap

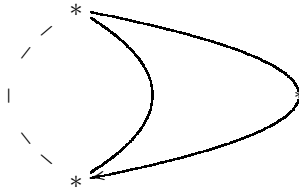

with a tYM-theory sitting at the very tip. By duality there is the corresponding straightened picture

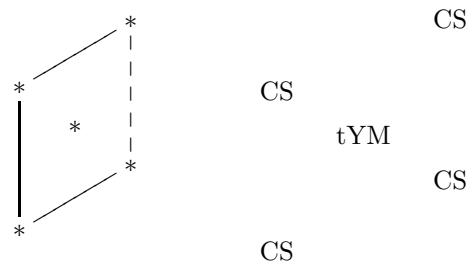

We now define a defect that factors through the universal Wilson defect of Def. 5.7.25 and reproduces the traditional Wilson line action functional. To that end, let $\nabla_{S^2} : S^2 \rightarrow \mathbf{B}T_{\text{conn}}$ be a T -principal connection on the 2-sphere, where T is the maximal torus of G . We may identify the integral of its curvature 2-form over the sphere with the weight λ ,

$$\lambda = \int_{S^2} F_{\nabla_{S^2}} .$$

Then consider the morphism

$$p_1^* \nabla_{S^1} + p_2^*(-) : \Omega^1(-, \mathfrak{g})//T \longrightarrow [S^2, \mathbf{B}G_{\text{conn}}]$$

in \mathbf{H} which over a test manifold $U \in \text{CartSp}$ sends a connection 1-form $A \in \Omega^1(U, \mathfrak{g})$ to

$$p_1^* \nabla_{S^2} + p_2^* A \in \mathbf{H}(S^2 \times U, \mathbf{B}G_{\text{conn}}) .$$

This is indeed a homomorphism since T is abelian.

Proposition 5.7.27. *We have the following*

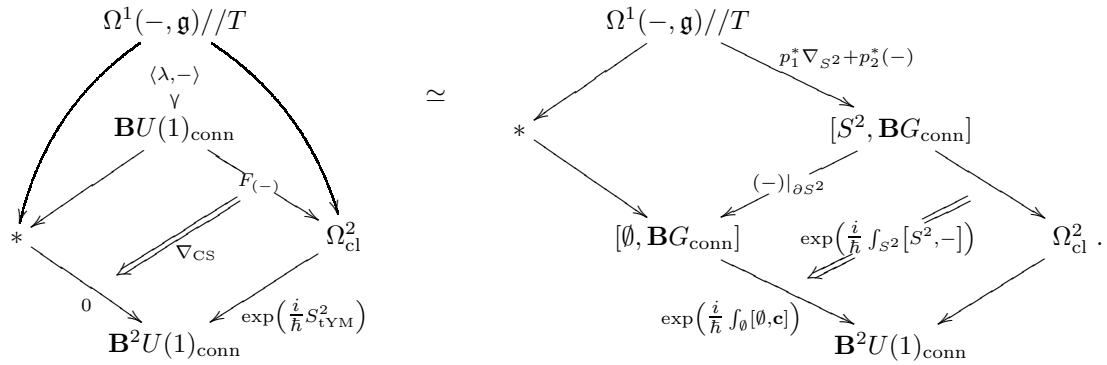

Proof. By construction and since T is abelian, the component of the Chern-Simons form of $p_1^* \nabla_{S^2} + p_2^* A$ with two legs along S^2 is proportional to $\langle F_{\nabla_{S^2}} \wedge A \rangle$. Hence its fiber integral over $S^2 \times U \rightarrow U$ is

$$\int_{S^2} \langle F_{\nabla_{S^2}} \wedge A \rangle = \langle \lambda, A \rangle .$$

□

Therefore in conclusion we find that we can axiomatize Wilson loops in 3d Chern-Simons theory by the following defect structure.

Definition 5.7.28. The *Wilson line defect* is

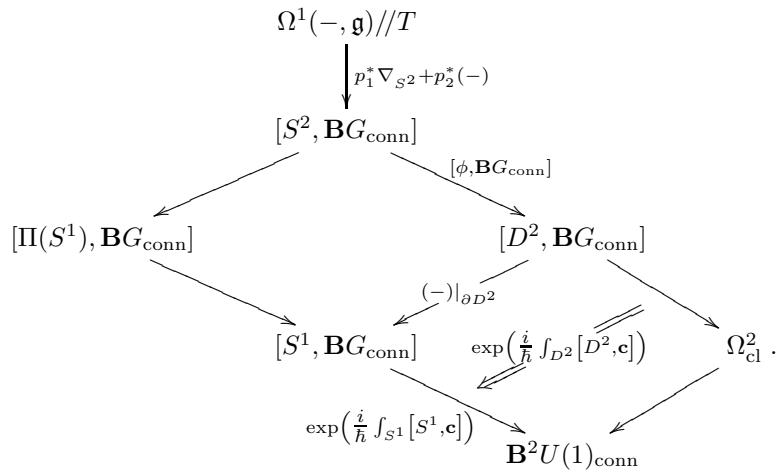

6 Outlook: Motivic quantization of local prequantum field theory

Above in 3.9.14 we discussed how local Lagrangian topological prequantum field theory with boundaries and defects is axiomatized in terms of local action functionals/higher prequantum bundles $\exp(\frac{i}{\hbar}S)$ on moduli stacks **Fields** corresponding to diagrams of symmetric monoidal (∞, n) -categories of the form

$$\begin{array}{ccc} \text{Bord}_n^{\text{sing}\otimes} & \xrightarrow{\exp(\frac{i}{\hbar}S)} & \text{Corr}_n(\mathbf{H}/\mathbf{Phases})^{\otimes} , \\ & \searrow^{\mathbf{Fields}} & \downarrow \\ & & \text{Corr}_n(\mathbf{H})^{\otimes} \end{array}$$

where \mathbf{H} is the ambient cohesive ∞ -topos.

By folk lore, a prequantum field theory with action functional $\exp(\frac{i}{\hbar}S)$ on **Fields** is supposed to induce a genuine quantum field theory given by a monoidal functor to some E -linear (∞, n) -category $E\text{Mod}_n$ (for some ground ring E) by a process that integrates the contributions of $\exp(\frac{i}{\hbar}S(\phi)) \in \mathbf{Phases}$ over all $\phi \in \mathbf{Fields}$ as E -modules, after a specified embedding $\mathbf{Phases} \hookrightarrow E\text{Mod}$. This *path integral* [FeHi65, Zi04] is traditionally denoted by the symbols on the left of

$$\int_{\phi \in \mathbf{Fields}} \exp(\frac{i}{\hbar}S(\phi)) D\phi : \text{Bord}_n^{\text{sing}\otimes} \longrightarrow E\text{Mod}_n^{\otimes} ,$$

where $D\phi$ is meant to suggest an integration measure on **Fields**.

We now indicate how to naturally and usefully make formal sense of this inside the tangent cohesive ∞ -topos $T\mathbf{H}$, 4.1 by fiber integration in twisted stable cohomology, 4.1.2.1. Then we indicate how in examples this general process reproduces traditional geometric quantization, 1.1.3, as the boundary quantum field theory of the non-perturbative local prequantum 2d Poisson-Chern-Simons theory of 5.4.3. We also indicate how higher analogs of this serve to quantize higher WZW-type p -brane σ -models as in 5.6 as boundary theories of the higher prequantum Chern-Simons theories in 5.5.

The material outlined here is due to [Nui13, Sc13c].

- 6.0.3 – Cohomological quantization of correspondences in a cohesive slice
- 6.0.4 – The quantum particle at the boundary of the string
- 6.0.5 – The quantum string at the boundary of the membrane

6.0.3 Cohomological quantization of correspondences in a cohesive slice

To begin the discussion at the absolute fundamentals, notice that the two hallmarks of quantum theory are (e.g. [Di87])

1. the superposition principle
2. quantum interference .

These say that 1. quantum phases may be additively combined such that 2. there are relations that make combinations sum to zero. This informal statement is formally captured by the passage from the circle group $U(1)$ of phases in which action functionals $\exp(\frac{i}{\hbar}S)$ traditionally take values, as discussed in 3.9.14.1.1, first to the group ring $\mathbb{Z}[U(1)]$, which is the universal context for adding phases, and then second to the quotient ring defined by the relations that regard addition of phases inside the complex numbers:

$$U(1) \hookrightarrow \mathbb{Z}[U(1)] \xrightarrow{\text{interference}} \mathbb{C} .$$

What is supposed to be integrated by the path integral is the thus linearized action functional $\rho \exp\left(\frac{i}{\hbar}S\right)$.
 Observe now that the free group ring construction $\mathbb{Z}[-]$ is the left adjoint in an adjunction

$$\mathbf{CRing} \begin{array}{c} \xleftarrow{\mathbb{Z}[-]} \\ \xrightarrow{\text{GL}_1} \end{array} \mathbf{AbGrp}$$

between commutative rings and abelian groups, whose right adjoint is the functor that sends a ring to its group of units. The corresponding adjunct of the map interference \circ superposition above is the group homomorphisms

$$\rho : U(1) \longrightarrow \text{GL}_1(\mathbb{C}),$$

which canonically embeds $U(1)$ into the group of units of the complex numbers. Being a Lie group homomorphism, this deloops to a morphism of moduli stacks

$$\mathbf{B}\rho : \mathbf{BU}(1) \longrightarrow \mathbf{BGL}_1(\mathbb{C}) \xrightarrow{\cong} \mathbf{CLine} \hookrightarrow \mathbf{CMod},$$

where on the right we observe that $\mathbf{BGL}_1(\mathbb{C})$ is equivalently the moduli stack of smooth complex line bundles which sits inside the moduli stack of smooth complex vector bundles.

Using this, we can canonically turn a action functional as in 3.9.14.1.1 into the corresponding integral kernel,

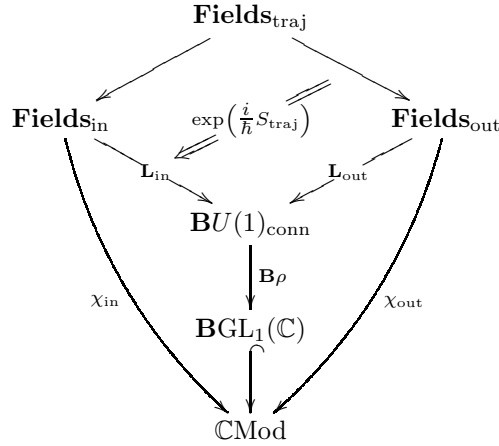

regarded as a gauge transformation between an incoming prequantum bundle χ_{in} and an outgoing prequantum bundle χ_{out} . Write then $\mathbb{C}^{\chi_{in}}(\mathbf{Fields}_{in})$ and $\mathbb{C}^{\chi_{out}}(\mathbf{Fields}_{out})$ for the space of sections of these prequantum line bundles, then the path integral over $\exp\left(\frac{i}{\hbar}S_{tra,j}\right)$ is supposed to produce a linear map

$$\mathbb{C}^{\chi_{in}}(\mathbf{Fields}_{in}) \longrightarrow \mathbb{C}^{\chi_{out}}(\mathbf{Fields}_{out}),$$

which would be the *quantum propagator* that takes incoming quantum states/wave functions to outgoing quantum states.

This story is quantum *mechanics*, hence 1-dimensional quantum field theory. By the discussion of higher dimensional local prequantum field theory in 3.9.14, for an n -dimensional local prequantum field theory the local action functional in full codimension is given by a Lagrangian \mathbf{L} which is a map of the form

$$\mathbf{L} : \mathbf{Fields} \longrightarrow \mathbf{B}^n U(1)_{conn}.$$

By direct analogy with the above discussion, we are therefore led to consider the following linearization of such local Lagrangians.

First observe, based on [ABG10a], that the above adjunction $(\mathbb{Z}[-] \dashv \text{GL}_1)$ generalizes to an ∞ -adjunction between E_∞ -rings in the ∞ -topos \mathbf{H} (see [L-Alg]) and abelian ∞ -group objects in \mathbf{H} , def. 3.6.117:

$$\mathbf{CRing}(\mathbf{H}) \begin{array}{c} \xleftarrow{\mathbb{S}[-]} \\ \xrightarrow{\text{GL}_1} \end{array} \mathbf{AbGrp}(\mathbf{H}).$$

Therefore for an n -dimensional field theory we are to look for a quotient E_∞ -ring E of the ∞ -group E_∞ -ring $\mathbb{S}[\mathbf{B}^{n-1}U(1)]$ on the circle n -group (def. 4.4.21)

$$\mathbf{B}^{n-1}U(1) \xrightarrow{\text{superposition}} \mathbb{S}[\mathbf{B}U(1)] \xrightarrow{\text{interference}} \mathbf{E} .$$

For instance for $n = 2$ there is a natural choice of quotient: by a smooth refinement of Snaith's theorem [Sn79] we can take²¹

$$\mathbf{K}U := \mathbb{S}[\mathbf{B}U(1)][\beta^{-1}]$$

to be the localization of the smooth group ∞ -ring of the circle 2-group at the smooth Hopf bundle Bott element. Since these are ∞ -colimit constructions, they are preserved by geometric realization, 4.4.4 and Snaith's theorem then says that this is the traditional complex K-theory spectrum

$$\Pi(\mathbf{K}U) \simeq \mathbb{S}[K(\mathbb{Z}, 2)][\beta^{-1}] \simeq KU .$$

We learn from this that 2-dimensional local pre-quantum field theory should have a natural quantization in K-theory, and indeed it does, as we describe in 6.0.4 below.

In this fashion, for suitable choices of *higher superposition principles*

$$\rho : \mathbf{B}^{n-1}U(1) \longrightarrow \mathrm{GL}_1(E)$$

we may E -linearize local action functionals to higher integral kernels given by pasting composites of the form

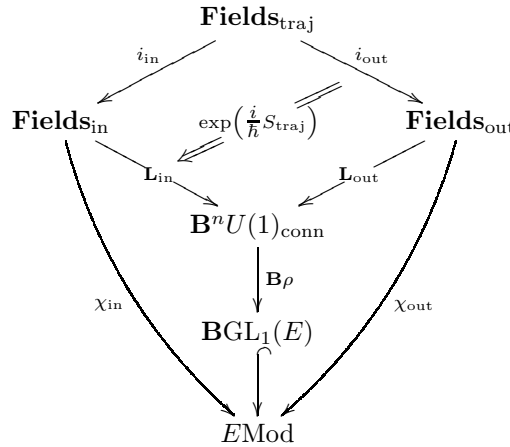

Notice that such a diagram is a correspondence in \mathbf{H} whose correspondence space $\mathbf{Fields}_{\text{traj}}$ is equipped with a cocycle in $(\chi_{\text{in}}, \chi_{\text{out}})$ -twisted bivariant E -cohomology theory. This is the broad structure of representatives of *pure motives* (see e.g. [Su08]), here generalized to cohesive higher moduli stacks and twisted bivariant generalized cohomology.

Forming the E -modules of sections of these higher prequantum E -line bundles precisely means forming χ -twisted E -cohomology spectra as in 4.1.2.1. Then a correspondence as above yields a co-correspondence of E -module spectra of the form

$$E^{\chi_{\text{in}}}(\mathbf{Fields}_{\text{in}}) \xrightarrow{i_{\text{in}}^*} E^{i_{\text{in}}^* \chi_{\text{in}}}(\mathbf{Fields}_{\text{traj}}) \simeq E^{i_{\text{out}}^* \chi_{\text{out}}}(\mathbf{Fields}_{\text{traj}}) \xleftarrow{i_{\text{out}}^*} (\mathbf{Fields}_{\text{out}}) E^{\chi_{\text{out}}}(\mathbf{Fields}_{\text{out}}) .$$

Now *integration* in this context means to dualize the morphism on the right (with respect to the tensor monoidal structure on $E\text{Mod}$) and to choose an equivalence of the E -modules with their (fiberwise) duals, this is the choice of *orientation in twisted E -cohomology*. The obstructions for such an orientation to exist by itself and moreover to exist in a consistent way that is compatible composition of correspondence (as

²¹I am grateful to Thomas Nikolaus for discussion of this point.

indicated in [FHT07]) are the *quantum anomalies*. If the orientation exists and has been consistently chosen, then we can form the *twisted Umkehr map* [ABG10b] $(i_{\text{out}})_!$, see [Nui13] for a review. This finally turns the above integral kernel into the *higher quantum propagator*

$$E\mathcal{X}^{\text{in}}(\mathbf{Fields}_{\text{in}}) \xrightarrow{(i_{\text{out}})_! \circ i_{\text{in}}^*} E\mathcal{X}^{\text{out}}(\mathbf{Fields}_{\text{out}}) .$$

In our first example in 6.0.4 below, in the case of $n = 2$ with $E = \text{KU}$ as above, this cohomological quantization is presented over moduli stacks which are Lie groupoids by the KK-theoretic constructions in [BMRS07], via [TXL04]. In [Mah13] it is shown that this indeed canonically maps into noncommutative motives (see e.g [BGT10]).

In summary, the quantization of of pre-quantum correspondences in the slice of a cohesive ∞ -topos via fiber integration in twisted stable cohomology corresponds to lifts of the original pre-quantum field theory as shown in the following diagram:

$$\begin{array}{c}
 \int_{\phi \in \mathbf{Fields}} \exp\left(\frac{i}{\hbar} S(\phi)\right) D\phi \\
 \text{Bord}_n^{\text{sing}} \otimes \xrightarrow{\exp\left(\frac{i}{\hbar} S\right) D(-)} \text{Corr}_n^{\text{or}}(\mathbf{H}/\mathbf{BGL}_1(\mathbf{E})) \otimes \xrightarrow{\int_{(-)} (-)} E\text{Mod}_n , \\
 \xrightarrow{\exp\left(\frac{i}{\hbar} S\right)} \text{Corr}_n(\mathbf{H}/\mathbf{Phases}) \otimes \xrightarrow{\rho} \text{Corr}_n(\mathbf{H}/\mathbf{BGL}_1(\mathbf{E})) \otimes \\
 \xrightarrow{\mathbf{Fields}} \text{Corr}_n(\mathbf{H}) \otimes \downarrow \\
 \text{Corr}_n(\mathbf{H}) \otimes
 \end{array}$$

Here

- **Fields** is the higher moduli stack of pre-quantum fields;
- $\exp\left(\frac{i}{\hbar} S\right)$ is the specified local action functional on **Fields**, defining the given pre-quantum field theory;
- ρ is the chosen higher superposition principle, linearizing in E -cohomology;
- $\exp\left(\frac{i}{\hbar} S\right) D(-)$ is a lift of the local action functional to consistently twisted E -oriented correspondences, hence is a choice of *cohomological path integral measure* on **Fields**;
- $\int_{\phi \in \mathbf{Fields}} \exp\left(\frac{i}{\hbar} S(\phi)\right) D(\phi)$ is the composition of the latter the previous item with the pull-push operation, this is the cohomological realization of the *path integral*.

This quantization process is particularly interesting for the boundary prequantum field theories discussed in 3.9.14.4, where it yields quantization of *geometric* (non-topological) field theories as the “holographic” boundaries of topological field theories in one dimension higher.

6.0.4 The quantum particle at the boundary of the string

We indicate how traditional geometric quantization of symplectic manifolds (e.g. [Br93]) arises as the motivic quantization of the canonical boundary field theory to the non-perturbative 2d Poisson-Chern-Simons field theory of 5.4.3. Then we observe that the same process more generally yields a notion of geometric quantization of Poisson manifolds. Given a compact Lie group G we find a pre-quantum defect between two Poisson-Chern-Simons boundary field theories whose cohomological quantization yields Kirillov’s orbit method in the K-theoretic incarnation given by Freed-Hopkins-Teleman.

6.0.4.1 Holographic geometric quantization of Poisson manifolds Given a Poisson manifold (X, π) , by the general construction of 5.5.11, as described in 5.4.3, there is a 2d Chern-Simons field theory induced by it, whose moduli stack of instanton sector of fields is the *symplectic groupoid* $\text{SympGrpd}(X, \pi)$, on which the local action functional induces a $\mathbf{BU}(1)$ -principal 2-bundle

$$\chi : \text{SympGrpd}(X, \pi) \longrightarrow \mathbf{B}^2U(1).$$

Now one observes that this is such that it trivializes when restricted along the canonical inclusion $X \longrightarrow \text{SympGrpd}(X, \pi)$ (which is the canonical atlas, def. 2.3.4). By the discussion in 3.9.14.4 this induces a boundary field theory for the 2d Poisson-Chern-Simons theory, exhibited by the correspondence

$$\begin{array}{ccc}
 & X & \\
 \swarrow & & \searrow i \\
 * & & \text{SympGrpd}(X, \pi) \\
 \searrow & \xleftarrow{\xi} & \swarrow \chi \\
 & \mathbf{B}^2U(1) &
 \end{array}$$

Here the trivialization ξ is a *prequantum bundle* on the Poisson manifold X .

Now since this is a correspondence with higher phases in $\mathbf{B}^2U(1)$, by the above discussion this situation is naturally quantized in twisted complex K -theory

$$\begin{array}{ccc}
 & X & \\
 \swarrow & & \searrow i \\
 * & & \text{SympGrpd}(X, \pi) \\
 \searrow & \xleftarrow{\xi} & \swarrow \chi \\
 & \mathbf{B}^2U(1) & \\
 & \downarrow \rho & \\
 & \mathbf{BGL}_1(\text{KU}) &
 \end{array}$$

If the morphism $i : X \longrightarrow \text{SympGrpd}(X, \pi)$ can be and is equipped with an orientation in χ -twisted K -theory (which usually involves in particular that we assume that X is compact), then pull-push yields a map of KU -module spectra of the form

$$i_! \xi : \text{KU} \longrightarrow \text{KU}^\chi(\text{SympGrpd}(X, \pi)).$$

This is equivalently an element in the twisted K -cohomology of the symplectic groupoid

$$i_! \xi \in \text{KU}^\chi(\text{SympGrpd}(X, \pi))$$

and this is to be regarded as the quantization of the Poisson manifold (X, π) .

Notice that the symplectic groupoid $\text{SympGrpd}(X, \pi)$ is a resolution of the space of symplectic leaves of (X, π) . Therefore a class in $\text{KU}^\chi(\text{SympGrpd}(X, \pi))$ may be thought of as providing one (virtual) vector space for each symplectic leaf, to be thought of as the space of quantum states. Specifically, when $(X, \pi) = (X, \omega^{-1})$ happens to be a symplectic manifold, then $\text{SympGrpd}(X, \pi) \simeq *$ (as smooth stacks) and so the above yields an element of the K -theory of the point. One checks that this coincides with the K -theoretic description of traditional geometric quantization.

If there is a compact group G of Hamiltonians acting on (X, ω^{-1}) by Hamiltonian actions, then by the discussion in 1.2.10.11, 3.9.13.5 we obtain a G -equivariant version of this situation exhibited by a correspondence of quotient stacks

$$\begin{array}{ccc}
 & X//G & \\
 \swarrow & & \searrow \\
 *//G & & *//G \\
 \searrow & \xleftarrow{\xi} & \swarrow \\
 & \mathbf{B}^2U(1) & \\
 & \downarrow \rho & \\
 & \mathbf{BGL}_1(\mathbf{KU}) &
 \end{array}$$

This now has a cohomological quantization if the G -action preserves the choice of K-orientation. If that comes from a Kähler polarization then this is the familiar condition on quantizability of prequantum operators. Now the pull-push quantization acts as

$$i_! : K(X//G) \simeq K_G(X) \longrightarrow K_G(*) \simeq K(*//G) \simeq \text{Rep}(G)$$

and refines $i_!\chi$ to a cocycle in G -equivariant K-theory. This is represented by the Hilbert space of quantum states equipped with its G -action by quantum observables. See section 5.2.1 in [Nui13].

Notice that this cohomological/geometric quantization of Poisson manifolds as the 1d boundary field theory of the non-perturbative 2d Poisson-Chern-Simons theory is conceptually analogous to the perturbative formal deformation quantization of Poisson manifolds given in [Kon03], which in [CaFe99] was found to be induced by the perturbative Poisson sigma-model. Another similar holographic quantization of 1d mechanics by a 2d string sigma-model was given in [GK08].

More generally, regard the dual vector space \mathfrak{g}^* of the Lie algebra of G as a Poisson manifold with its Lie-Poisson structure. The corresponding symplectic groupoid is the adjoint action groupoid

$$\text{SympGrpd}(\mathfrak{g}^*, [-, -]) \simeq \mathfrak{g}^*//G.$$

Then for O_λ any regular coadjoint orbit, we get the following correspondence of correspondences in \mathbf{H} :

$$\begin{array}{ccc}
 * & \xleftarrow{\quad} * & \xrightarrow{\quad} * & \text{trivial theory} \\
 \uparrow & & \uparrow & \\
 O_\lambda//G & \xleftarrow{\quad} O_\lambda & \xrightarrow{\quad} \mathfrak{g}^* & \text{boundary} \\
 \downarrow & & \downarrow & \\
 //G & \xleftarrow{\quad} O_\lambda//G & \xrightarrow{\quad} \mathfrak{g}^//G & \text{2dCS} \\
 \\
 & \text{2dCS} & \text{defect} & \text{2dCS}
 \end{array}$$

Here on the left we have the symplectic manifold O_λ regarded as a G -equivariant boundary field theory of its 2d Poisson-Chern-Simons theory as just discussed. On the right we have the Poisson manifold \mathfrak{g}^* regarded as the boundary of its 2d Poisson-Chern-Simons theory as above. The whole diagram is equipped with maps down to $\mathbf{B}^2U(1)$ as in prop. 3.9.135, which we will not display here. As such the diagram exhibits a defect at which these two boundary conditions meet. The quantization of the left boundary theory yields a space of states realized as an element in the representation ring of G , which is the K-theoretic formulation

of Kirillov’s orbit method. The quantization of the defect yields a quantum operator which produces such representations from prequantum bundles over \mathfrak{g}^* . Analysis of the details shows that this defect operator is effectively the “inverse universal orbit method” of theorem 1.28 in [FHT05]. See 1.2.15.1.5 above for discussion of the orbit method and its physical interpretation. See section 5.2.2 of [Nui13] for more details on this defect quantization.

6.0.4.2 D-brane charge While by the above the endpoints of the Poisson-Chern-Simons string serve to exhibit every possible mechanical system, we can also consider endpoints of the (topological sector) of the type II superstring. This is the σ -model on a target manifold X equipped with a background B-field whose instanton sector we denote by $\chi_B : X \rightarrow \mathbf{B}^2U(1)$. A boundary condition for this which is given by a submanifold $Q \hookrightarrow X$ is precisely a choice of trivialization ξ of χ_B on that submanifold

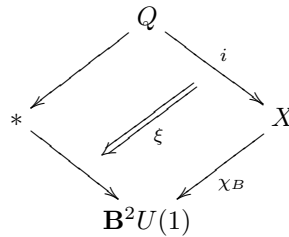

This ξ now plays the role of the Chan-Paton gauge field on the D -brane Q . The cohomological quantization of this correspondence in K-theory as above exists if $Q \hookrightarrow X$ is χ -twisted K-orientable, which is precisely the Freed-Witten anomaly cancellation condition, see 1.2.15.2. In this case the quantization yields the class

$$i_! \xi \in K^{\chi_B}(X)$$

in the B-field twisted K-theory of spacetime. This is what is known as the D -brane charge of (Q, ξ) [BMRS07]. See section 5.2.4 of [Nui13] for more details.

6.0.5 The quantum string at the boundary of the membrane

We consider the above holographic quantization of the particle at the boundary of the string in one dimension higher, and indicate the cohomological quantization of the string at the boundary of the membrane.

To that end, let $\chi_C : Y//\mathbb{Z}_2 \rightarrow \mathbf{B}^3U(1)$ be (the 3-bundle underlying) the supergravity C -field on an 11-dimensional Hořava-Witten spacetime, as discussed above in 5.2.9. By the discussion there, this class is of the form $\frac{1}{2}p_1 + 2a$ and on the higher orientifold plane 10-dimensional boundary $X \hookrightarrow Y$ this class trivializes. By the discussion in 5.2.7.3 the choice of trivialization χ_B is the twisted B-field of the heterotic string theory on X , representing a $2a$ -twisted string structure.

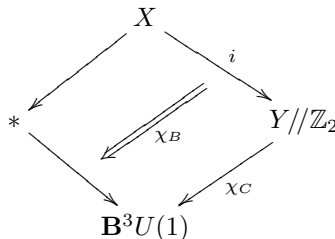

Now since χ_C is the background field for the topological sector of the M2-brane, 5.6.4.1, by the general discussion of 3.9.14.4 we see that this diagram exhibits a boundary condition for the M2-brane ending on the O9-plane X . This boundary string of the M2 on the O9 is the heterotic string. By comparison with 6.0.4 we see that therefore the cohomological quantization of this correspondence should yield the partition function of the string.

To see this, notice that by the general discussion in 6.0.3 we are to choose a higher superposition principle by finding an E_∞ -ring E such that there is a natural higher group homomorphism

$$\mathbf{B}^2U(1) \longrightarrow \mathbf{IIB}^2U(1) \simeq K(\mathbb{Z}, 3) \longrightarrow \mathrm{GL}_1(E).$$

There is one famous such choice [ABG10a], namely $E = \mathrm{tmf}$, the “universal elliptic cohomology theory”.

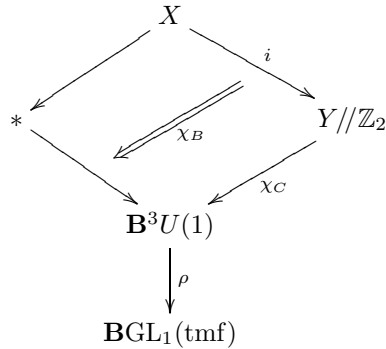

A cohomological quantization of this exists now if we have an orientation in twisted tmf , hence by twisted string structures.²² If it exists, push-forward in tmf yields [AHR10] the (twisted [CHZ10]) *Witten genus*. By the seminal result of [Wi87] this is the partition function of the heterotic string.

By analogy with 6.0.4.2 we may also regard this push-forward in tmf as the “O9-plane charge”. An analogous story should apply to the cohomological quantization of the M2-brane ending not on the O9-plane, but on the M5-brane, by 5.6.4.4. In this case the result of the quantization would be an M5-brane charge in tmf , induced not by the heterotic, but by the self-dual string on the M5. That this is the case is the statement of proposal 6.13 in [Sa10a].

²² This point in [ABG10a] was originally amplified by Hisham Sati in work that led to the discussion in 5.2.6.2 above.

References

- [AETW87] A. Achúcarro, J. M. Evans, P. Townsend, and D. L. Wiltshire, *Super p -branes*, Phys. Lett. **B** **198** (1987), 441–446.
- [AGMOO] O. Aharony, S. Gubser, J. Maldacena, H. Ooguri, Y. Oz, *Large N Field Theories, String Theory and Gravity*, Phys.Rept.323:183-386,2000, [[hep-th/9905111](#)]
- [ACDP03] D. Alekseevsky, V. Cortés, C. Devchand, A. Van Proeyen, *Polyvector Super-Poincaré Algebras*, Commun.Math.Phys. 253 (2004) 385-422, [arXiv:hep-th/0311107](#)
- [AKSZ97] M. Alexandrov, M. Kontsevich, A. Schwarz, O. Zaboronsky, *The geometry of the master equation and topological quantum field theory*, Int. J. Modern Phys. A 12(7):14051429, (1997)
- [ABG10a] M. Ando, A. Blumberg, D. Gepner, *Twists of K -theory and TMF* , (2010) [arXiv:1002.3004](#)
- [ABG10b] M. Ando, A. Blumberg, D. Gepner, *Twists of K -theory and TMF* , in Robert S. Doran, Greg Friedman, Jonathan Rosenberg, *Superstrings, Geometry, Topology, and C^* -algebras*, Proceedings of Symposia in Pure Mathematics vol 81, American Mathematical Society [arXiv:0712.2817](#)
- [ABGHR08] M. Ando, A. Blumberg, D. Gepner, M. Hopkins, C. Rezk, *Units of ring spectra and Thom spectra*, Journal of Topology, [arXiv:0810.4535](#)
- [AHR10] M. Ando, M. Hopkins, C. Rezk, *Multiplicative orientations of KO -theory and the spectrum of topological modular forms*, 2010
<http://www.math.uiuc.edu/~mando/papers/koandtmf.pdf>
- [An04] I. Androulidakis, *Classification of extensions of principal bundles and transitive Lie groupoids with prescribed kernel and cokernel*, J. Math. Phys. 45, 3995 (2004)
- [Ar89] V. Arnold, *Mathematical methods of classical mechanics*, Graduate Texts in Mathematics (1989)
- [ArMa66] M. Artin, B. Mazur, *On the van Kampen theorem*, Topology 5 (1966) 179189
- [ArMa69] M. Artin, B. Mazur, *étale homotopy*, Lecture Notes in Mathematics No. 100, Springer-Verlag, Berlin (1969)
- [At57] M. Atiyah, *Complex analytic connections in fibre bundles*, Trans. Amer. Math. Soc. 85 (1957)
- [AzTo89] J. Azcárraga and P. Townsend, *Superspace geometry and the classification of supersymmetric extended objects*, Phys. Rev. Lett. **62**, (1989), 2579–2582.
- [AzIz95] J. A. de Azcárraga, J. Izquierdo, *Lie Groups, Lie Algebras, Cohomology and Some Applications in Physics*, Cambridge monographs of mathematical physics, (1995)
- [BaDo95] J. Baez, J. Dolan, *Higher dimensional algebra and Topological Quantum Field Theory*, J.Math.Phys. 36 (1995) 6073-6105
- [BaHo09] J. Baez and A. Hoffnung *Convenient categories of smooth spaces*, Transactions of the AMS
- [BHR08] J. Baez, A. Hoffnung, C. Rogers, *Categorified symplectic geometry and the classical string*, Comm. Math. Phys. **293** (2010), 701–715 [arXiv:0808.0246](#)
- [BaRo09] J. Baez, C. Rogers, *Categorified symplectic geometry and the string Lie 2-algebra*, Homology Homotopy Appl. 12 (2010), 221-236, [arXiv:0901.4721](#)
- [BaH10] J. Baez and J. Huerta, *Division Algebras and Supersymmetry II*, Adv. Theor. Math. Phys. **15** (2011), no. 5, 1373–1410, [arXiv:1003.3436](#).

- [BBS78] A. P. Balachandran, S. Borchardt, and A. Stern, *Lagrangian and Hamiltonian descriptions of Yang-Mills particles*, Phys. Rev. **D 17** (1978), 3247–3256.
- [BLNPST97] I. Bandos, K. Lechner, A. Nurmagametov, P. Pasti, D. Sorokin and M. Tonin, *Covariant action for the super-fivebrane of M-theory*, Phys. Rev. Lett. **78** (1997), 4332, [[arXiv:hep-th/9701149](https://arxiv.org/abs/hep-th/9701149)].
- [BFSS96] T. Banks, W. Fischler, S. H. Shenker, and L. Susskind, *M theory as a matrix model: A conjecture*, Phys. Rev. **D55** (1997), 5112–5128, [[arXiv:hep-th/9610043](https://arxiv.org/abs/hep-th/9610043)].
- [Ba11] D. Baraglia, *Leibniz algebroids, twistings and exceptional generalized geometry*, J. Geom. Phys. **62** (2012), 903–934, [arXiv:1101.0856](https://arxiv.org/abs/1101.0856)
- [Be02] C. Beasley, *Localization for Wilson loops in Chern-Simons theory*, in J. Andersen et al. (eds.), *Chern-Simons Gauge Theory: 20 Years After*, AMS/IP Studies in Adv. Math., Vol. 50, AMS, Providence, RI, 2011, [arXiv:0911.2687](https://arxiv.org/abs/0911.2687).
- [Bel85] A. Beilinson, *Notes on absolute Hodge cohomology*, Applications of algebraic K-theory to algebraic geometry and number theory, Part I, II, Contemp. Math., 55, Amer. Math. Soc., Providence, RI, (1986)
- [BeDr04] A. Beilinson, V. Drinfeld, *Chiral algebras*, American Mathematical Society (2004)
- [BeMo06] D. Belov, G. Moore, *Holographic action for the self-dual field*, [arXiv:hep-th/0605038](https://arxiv.org/abs/hep-th/0605038)
- [Be10] J. Bergner, *Models for (∞, n) -Categories and the Cobordism Hypothesis*, in H. Sati, U. Schreiber (eds.) *Mathematical Foundations of Quantum Field Theory and Perturbative String Theory*, Proceedings of Symposia in Pure Mathematics, volume 83 AMS (2011), [arXiv:1011.0110](https://arxiv.org/abs/1011.0110)
- [Be08a] J. Bergner, *Adding inverses to diagrams encoding algebraic structures*, Homology, Homotopy and Applications 10 (2008), no. 2, 149–174
- [Be08b] J. Bergner, *Adding inverses to diagrams II: Invertible homotopy theories are spaces*, Homology, Homotopy and Applications, Vol. 10 (2008), No. 2, 175–193.
- [Blan85] P. Blanc, *Cohomologie différentiable et changement de groupes* Astérisque vol. 124-125 (1985), pp. 113-130
- [BlCh12] M. Blomgren, W. Chacholski, *On the classification of fibrations*, [arXiv:1206.4443](https://arxiv.org/abs/1206.4443)
- [BGT10] A. Blumberg, D. Gepner, G. Tabuada, *A universal characterization of higher algebraic K-theory*, Geometry and Topology 17 (2013) 733838, [arXiv:1001.2282](https://arxiv.org/abs/1001.2282)
- [BoWa58] W. M. Boothby, H. C. Wang, *On contact manifolds*, Ann. of Math. (2) 68 (1958) 721734
- [Borc94] F. Borceux, *Handbook of categorical algebra*, Encyclopedia of Mathematics and its Applications, Cambridge University Press (1994)
- [Bors48] K. Borsuk, *On the imbedding of systems of compacta in simplicial complexes* Fund. Math 35, (1948) 217-234
- [BoTo82] R. Bott, L. Tu, *Differential forms in algebraic topology*, Graduate Texts in Mathematics 82, Springer 1982
- [Bo11] P. Bouwknegt, *Algebroids and generalizations of geometry*, talk at *String-Math 2011*, http://www.math.upenn.edu/StringMath2011/notes/Bouwknegt_StringMath2011_talk.pdf
- [Bott58] R. Bott, *The space of loops on a Lie group*, Michigan Math. J., 5:3561, (1958)

- [BoSa58] R. Bott, H. Samelson, *Application of the theory of Morse to symmetric spaces*, Amer. J. Math., 80 (1958), 964-1029.
- [Br10a] F. Brandt, *Supersymmetry algebra cohomology II: Primitive elements in 2 and 3 dimensions*, J. Math. Phys. **51** (2010) 112303, [arXiv:1004.2978](#)
- [Br10b] F. Brandt, *Supersymmetry algebra cohomology III: Primitive elements in four and five dimensions*, J. Math. Phys. **52** (2011), 052301, [arXiv:1005.2102](#)
- [Br13] F. Brandt, *Supersymmetry algebra cohomology IV: Primitive elements in all dimensions from $D = 4$ to $D = 11$* , J. Math. Phys. **54** (2013), 052302, [arXiv:1303.6211](#)
- [Br90] L. Breen, *Bitorseurs et cohomologie non abélienne*, In *Grothendieck Festschrift*, pages 401-476 (1990)
- [Br94] L. Breen, *On the classification of 2-gerbes and 2-stacks*, Astérisque 225 (1994)
- [Br06] L. Breen, *Notes on 1- and 2-gerbes*, in J. Baez, P. May (eds.), *Towards higher categories*, Springer (2010) [arXiv:math/0611317](#)
- [BM00] L. Breen, W. Messing, *Combinatorial differential forms*, Laboratoire analyse, géométrie et applications, Unite mixte de recherche, Institut Galilée, Université Paris 13, C.N.R.S. (2000) [arXiv:0005087](#)
- [BMRS07] J. Brodzki, V. Mathai, J. Rosenberg, R. Szabo, *Noncommutative correspondences, duality and D-branes in bivariant K-theory*, Adv. Theor. Math. Phys.13 : 497-552,2009, [arXiv.0708.2648](#)
- [Br73] K. Brown, *Abstract Homotopy Theory and Generalized Sheaf Cohomology*, Transactions of the American Mathematical Society, Vol. 186 (1973), 419-458
- [BrHiSi11] R. Brown, P. Higgins, R. Sivera, *Nonabelian Algebraic Topology Tracts in Mathematics 15*, European Mathematical Society (2011)
- [BrSz89] E. Brown and R. Szczarba, *Continuous cohomology and real homotopy type*, *Transactions of the AMS*, volume 311, number 1, (1989)
- [Br93] J.-L. Brylinski, *Loop spaces, Characteristic Classes and Geometric Quantization*, Birkhäuser (1993)
- [Bry00] J.-L. Brylinski, *Differentiable Cohomology of Gauge Groups*, [arXiv:math/0011069](#)
- [BrMc93] J.-L. Brylinski and D. McLaughlin, *A geometric construction of the first Pontryagin class*, In *Quantum topology*, volume 3 of *Ser. Knots Everything*, pages 209–220. World Sci. Publ., River Edge, NJ, 1993.
- [BrMc94] J.-L. Brylinski and D. McLaughlin, *The geometry of degree-four characteristic classes and of line bundles on loop spaces. I*, *Duke Math. J.*, 75(3):603–638, 1994.
- [BrMc96a] J.-L. Brylinski and D. McLaughlin, *The geometry of degree-4 characteristic classes and of line bundles on loop spaces. II*, *Duke Math. J.*, 83(1):105–139, 1996.
- [BrMc96b] J.-L. Brylinski and D. A. McLaughlin, *Čech cocycles for characteristic classes*, *Comm. Math. Phys.*, 178(1):225–236, 1996.
- [BCSS07] J. Baez, A. Crans, U. Schreiber, D. Stevenson, *From loop groups to 2-groups*, *Homology, Homotopy Appl.*, 9(2):101–135, 2007.
- [BSt] J. Baez, D. Stevenson. *The classifying space of a topological 2-group in Algebraic topology*, volume 4 of *Abel Symp.*, pages 1–31. Springer, Berlin, (2009)

- [But06] J. Butterfield, *On symmetry and conserved quantities in classical mechanics*, in *Physical Theory and its Interpretation*, The Western Ontario Series in Philosophy of Science Volume 72, 2006, pp 43-100 (2006)
<http://ncatlab.org/nlab/files/ButterfieldNoether.pdf>
- [BFG] M. Ballejos,; E. Faro, ; M. A. García-Muñoz, *Homotopy colimits and cohomology with local coefficients*, Cahiers, 44 no. 1 (2003), p. 63-80
- [BFGM] M. Ballejos, E. Faro, M.A. García-Muñoz, *Postnikov Invariants of Crossed Complexes*, Journal of Algebra, Volume 285, Issue 1, (2005) [arXiv:math/0409339](https://arxiv.org/abs/math/0409339)
- [Bun09] U. Bunke, *String structures and trivialisations of a Pfaffian line bundle*, Communications in Mathematical Physics, 2011, Volume 307, Issue 3, pp 675-712 [arXiv:0909.0846](https://arxiv.org/abs/0909.0846)
- [Bun12] U. Bunke, *Differential cohomology* [arXiv:1208.3961](https://arxiv.org/abs/1208.3961)
- [BNV13] U. Bunke, T. Nikolaus, M. Völkl, *Differential cohomology as sheaves of spectra*
- [BuSc10] U. Bunke, T. Schick, *Differential K-theory. A Survey*, (2010) in *Global Differential Geometry* Springer Proceedings in Mathematics Volume 17, 2012, pp 303-357 [arXiv:1011.6663](https://arxiv.org/abs/1011.6663)
- [CaRo12] D. Carchedi, D. Roytenberg, *On theories of superalgebras of differentiable functions*, Theory and Applications of Categories, Vol. 28, 2013, No. 30, pp 1022-1098. [arXiv:1211.6134](https://arxiv.org/abs/1211.6134)
- [CaSc] D. Carchedi, U. Schreiber *Concrete ∞ -stacks*
- [CJKP97] A. Carboni, G. Janelidze, G. M. Kelly, R. Paré, *On localization and stabilization for factorization systems*, Applied categorical structures 5, 1-58 (1997)
- [Ca12] D. Carchedi, *Étale Stacks as Prolongations*, [arXiv:1212.2282](https://arxiv.org/abs/1212.2282)
- [CBMMS02] A. Carey, P. Bouwknegt, V. Mathai, M. Murray, D. Stevenson, *Twisted K-theory and K-theory of bundle gerbes and*, *Commun Math Phys*, 228 (2002) 17-49, [arXiv:hep-th/0106194](https://arxiv.org/abs/hep-th/0106194)
- [CJM02] A. Carey, S. Johnson, M. Murray, *Holonomy on D-Branes*, *J. Geom. Phys.* 52 (2004) 186-216, [arXiv:hep-th/0204199](https://arxiv.org/abs/hep-th/0204199)
- [CJMSW05] A. Carey, S. Johnson, M. Murray, D. Stevenson, B.-L. Wang, *Bundle gerbes for Chern-Simons and Wess-Zumino-Witten theories*, *Commun.Math.Phys.* 259 (2005) 577-613 [arXiv:math/0410013](https://arxiv.org/abs/math/0410013)
- [Cart50a] H. Cartan, *Cohomologie réelle d'un espace fibré principal différentielle (i)*. In *Séminaire Henri Cartan;1949/50*,. CBRM, (1950)
- [Cart50b] H. Cartan, *Cohomologie réelle d'un espace fibré principal différentielle II*. in *Séminaire Henri Cartan; 1949/50* CBRM, (1950)
- [Cas05] L. Castellani, *Lie derivatives along antisymmetric tensors, and the M-theory superalgebra*, [arXiv:hep-th/0508213](https://arxiv.org/abs/hep-th/0508213)
- [CaDAFr91] L. Castellani, R. D'Auria, P. Fré, *Supergravity and Superstrings – A geometric perspective*, World Scientific (1991)
- [CaCo04] J. Castiglioni, G. Cortiñas, *Cosimplicial versus DG-rings: a version of the Dold-Kan correspondence*, *J. Pure Appl. Algebra* 191 (2004), no. 1-2, 119–142, [arXiv:math/0306289](https://arxiv.org/abs/math/0306289)
- [Ca95] L. Castellani, *Lie derivatives along antisymmetric tensors, and the M-theory superalgebra*, [arXiv:hep-th/0508213](https://arxiv.org/abs/hep-th/0508213)

- [CaFe99] A. Cattaneo, G. Felder, *A path integral approach to the Kontsevich quantization formula*, Commun. Math. Phys. 212, 591611 (2000), arXiv:math/9902090 and *Poisson sigma models and deformation quantization*, Mod. Phys. Lett. A 16, 179190 (2001), arXiv:hep-th/0102208
- [CaFe00] A. Cattaneo, G. Felder, *Poisson sigma models and symplectic groupoids*, in *Quantization of singular symplectic quotients*, Progr. Math., vol. 198 Birkhäuser, Basel (2001)
- [CaFe03] A. Cattaneo, G. Felder, *Coisotropic submanifolds in Poisson geometry and branes in the Poisson sigma model*, Lett. Math. Phys. 69 (2004) 157-175, arXiv:math/0309180
- [CMR12a] A. S. Cattaneo, P. Mnev and N. Reshetikhin, *Classical BV theories on manifolds with boundary*, arXiv:1201.0290
- [CMR12b] A. Cattaneo, P. Mnev, N. Reshetikhin, *Classical and quantum Lagrangian field theories with boundary*, arXiv:1207.0239
- [CeRe05] A. Cegarra, J. Remedios, *The relationship between the diagonal and the bar constructions on a bisimplicial set*, Topology and its applications, vol 153, number 1 (2005)
- [CRV] C. Centazzo, J. Rosický, E. Vitale, *A characterization of locally \mathbb{D} -presentable categories* <http://perso.uclouvain.be/enrico.vitale/ClaudiaJiri.pdf>
- [Ch81] A. Chamseddine, *Interacting supergravity in ten-dimensions: the role of the six-index gauge field*, Phys. Rev. **D24** (1981) 3065.
- [Chen77] K.-T. Chen *Iterated path integrals*, Bull. AMS 83, (1977), 831879.
- [CHZ10] Q. Chen, F. Han, W. Zhang, *Generalized Witten Genus and Vanishing Theorems*, J. Differential Geom. Volume 88, Number 1 (2011), 1-39 arXiv:1003.2325
- [Cher52] S.-s. Chern, *Differential geometry of fiber bundles*, In *Proceedings of the International Congress of Mathematicians, Cambridge, Mass., 1950, vol. 2*, pages 397–411, Providence, R. I., 1952. Amer. Math. Soc.
- [ChSi74] , S.-s. Chern, J. Simons, *Characteristic forms and geometric invariants*, Annals of Mathematics, Second Series, Vol. 99, No. 1 (1974)
- [CdAIP99] C. Chryssomalakos, J. A. de Azcárraga, J. M. Izquierdo, and J. C. Peřez Bueno, *The geometry of branes and extended superspaces*, Nucl. Phys. **B 567**(2000), 293–330, arXiv:hep-th/9904137
- [Ci10] D.-C. Cisinski, *Invariance de la K-Théorie par équivalences dérivées*, Journal of K-theory 6 (2010)
- [CiSh13] D.-C. Cisinski, M. Shulman, *Characterizations of locally presentable $(\infty, 1)$ -categories*, [http://ncatlab.org/nlab/show/locally+cartesian+closed+\(infinity,1\)-category#Presentations](http://ncatlab.org/nlab/show/locally+cartesian+closed+(infinity,1)-category#Presentations)
- [ClDy11] P. Clairambault, P. Dybjer, *The Biequivalence of Locally Cartesian Closed Categories and Martin-Löf Type Theories*, Lecture Notes in Comput. Sci. 6690, Springer 2011, arXiv:1112.3456
- [Col11] B. Collier, *Infinitesimal Symmetries of Dixmier-Douady Gerbes*, arXiv:1108.1525
- [Cor04] L. Corry, *David Hilbert and the axiomatization of physics: From Grundlagen der Geometrie to Grundlagen der Physik*, Archimedes: New Studies in the History and Philosophy of Science and Technology 10, Kluwer Academic Publishers, Dordrecht 2004.
- [Cor06] L. Corry, *On the origins of Hilbert's sixth problem: physics and the empiricist approach to axiomatization*, Proceedings of the International Congress of Mathematics in Madrid 2006
- [CrWi87] C. Crnković, E. Witten, *Covariant Description of Canonical Formalism in Geometrical Theories*, in *Three Hundred Years of Gravitation*, Cambridge University Press, Cambridge, 1987, pp. 676-684.

- [dAFR80] R. D’Auria, P. Fré, and T. Regge, *Graded Lie algebra, cohomology and supergravity*, Riv. Nuovo Cimento **3** (1980), 1–37.
- [dAFr82] R. D’Auria, P. Fré, *Geometric supergravity in $D = 11$ and its hidden supergroup*, Nuclear Physics B, 201 (1982)
- [DKR11] A. Davydov, L. Kong, I. Runkel, *Field theories with defects and the centre functor*, in H. Sati, U. Schreiber (eds.) *Mathematical Foundations of Quantum Field Theory and Perturbative String Theory*, Proceedings of Symposia in Pure Mathematics, volume 83 AMS (2011), arXiv:1107.0495
- [Del71] P. Deligne, *Théorie de Hodge II*, IHES Pub. Math. no 40 (1971), 5-57
- [DeMo99] P. Deligne, P. Etingof, D. Freed, L. Jeffrey, D. Kazhdan, J. Morgan, D. Morrison, E. Witten, *Quantum Fields and Strings – A course for mathematicians* (2 volumes) AMS (1999), www.math.ias.edu/qft
- [DelMor99] P. Deligne, J. Morgan *Notes on supersymmetry (following Joseph Bernstein)*, in [DeMo99] vol. 1, from p. 41.
- [Di87] P. A. M. Dirac, *The principles of quantum mechanics*, International series of monographs on physics, Oxford University Press, 1987
- [DiSh07] J. Distler, E. Sharpe, *Heterotic compactifications with principal bundles for general groups and general levels*, Adv. Theor. Math. Phys. 14:335-398, 2010, arXiv:hep-th/0701244
- [Do06] C. Douglas, *On the Twisted K -Homology of Simple Lie Groups*, Topology, Volume 45, Issue 6, November 2006, Pages 955-988, arXiv:0402082
- [Duf08] M. Duff, *Near-horizon brane-scan revived*, Nucl. Phys. **B 810** (2009), 193–209, arXiv:0804.3675
- [DLM95] M. Duff, J. Liu, R. Minasian, *Eleven-dimensional origin of string-string duality: A One loop test*, Nucl. Phys. **B452** (1995) 261-282, arXiv:hep-th/9506126
- [Dus75] J. Duskin, *Simplicial methods and the interpretation of “triple” cohomology* Mem. Amer. Math. Soc., 3, number 163, Amer. Math. Soc. (1975)
- [DiFrMo11] J. Distler, D. Freed, G. Moore, *Orientifold precis* in: H. Sati, U. Schreiber (eds.), *Mathematical Foundations of Quantum Field and perturbative String Theory* Proceedings of Symposia in Pure Mathematics, AMS (2011)
- [DHH10] C. Douglas, A. Henriques, M. Hill, *Homological Obstructions to String Orientations*, It. Math Res Notices (2010)
- [Dub79] E. Dubuc, *Concrete quasitopoi*, Lecture Notes in Math. 753 (1979), 239254
- [Dub79b] E. Dubuc, *Sur les modeles de la géometrie différentielle synthétique*, Cahiers de Topologie et Géométrie Différentielle Catégoriques, 20 no. 3 (1979), p. 231-279
- [Dub00] E. Dubuc, *Axiomatic étale maps and a theorem of spectrum*, Journal of pure and applied Algebra 149 (2000)
- [Duf87] M. Duff, *Supermembranes: the first fifteen weeks* CERN-TH.4797/87 (1987)
<http://ccdb4fs.kek.jp/cgi-bin/img/allpdf?198708425>
- [Dug99] D. Dugger, *Sheaves and homotopy theory* (1999)
<http://pages.uoregon.edu/ddugger/cech.html>
- [Dug01] D. Dugger, *Universal homotopy theories*, Adv. Math., 164(1):144–176 (2001)

- [DHS04] D. Dugger, S. Hollander, D. Isaksen. *Hypercovers and simplicial presheaves*, Math. Proc. Cambridge Philos. Soc., 136(1):9–51, 2004.
- [DwKa80a] W. Dwyer, D. Kan *Calculating simplicial localizations*, J. Pure Appl. Algebra 18 (1980)
- [DwKa80b] W. Dwyer, D. Kan *Function complexes in homotopical algebra*, Topology vol 19 (1980)
- [DwKa84a] W. Dwyer, D. Kan, *A classification theorem for diagrams of simplicial sets*, Topology 23 (1984), 139-155.
- [DwKa84b] W. Dwyer, D. Kan. *An obstruction theory for diagrams of simplicial sets*, *Nederl. Akad. Wetensch. Indag. Math.*, 46(2):139–146, 1984.
- [EMRV98] A. Echeverria-Enriquez, M. Munoz-Lecanda, N. Roman-Roy, C. Victoria-Monge, *Mathematical Foundations of Geometric Quantization*, Extracta Math. 13 (1998) 135-238 [arXiv:math-ph/9904008](https://arxiv.org/abs/math-ph/9904008)
- [Ehre51] C. Ehresmann. *Les connexions infinitésimales dans un espace fibré différentiable*, in *Colloque de topologie (espaces fibrés)*, Bruxelles, (1950) pages 29–55. Georges Thone, Liège, (1951)
- [EM53] S. Eilenberg, S. Mac Lane, *On the groups $H(\Pi, n)$, I*, Ann. of Math. (2) 58, (1953) 55106.
- [Et03] J. Etnyre, *Introductory lectures on contact geometry* Proc. Sympos. Pure Math. 71 (2003), 81-107.
- [EvSa06] J. Evslin and H. Sati, *Can D-branes wrap nonrepresentable cycles?*, J. High Energy Phys. **0610** (2006), 050, [arXiv:hep-th/0607045](https://arxiv.org/abs/hep-th/0607045)
- [Fal] A. Falkowski, *Five dimensional locally supersymmetric theories with branes*, Master Thesis, Warsaw <http://www.fuw.edu.pl/~afalkows/Work/Files/msct.ps.gz>
- [FeHi65] R. Feynman, A. Hibbs, *Quantum Mechanics and Path Integrals*, McGraw-Hill, New York, 1965.
- [Fe85] R. Feynman, *QED: The Strange Theory of Light and Matter*, Princeton University Press, 1985
- [FRS11] D. Fiorenza, C. L. Rogers, U. Schreiber, *A higher Chern-Weil derivation of AKSZ sigma-models*, International Journal of Geometric Methods in Modern Physics, Vol. 10, No. 1 (2013), [arXiv:1108.4378](https://arxiv.org/abs/1108.4378)
- [FRS13a] D. Fiorenza, C. L. Rogers, U. Schreiber, *Higher geometric prequantum theory*, [arXiv:1304.0236](https://arxiv.org/abs/1304.0236)
- [FRS13b] D. Fiorenza, C. L. Rogers, U. Schreiber, *L_∞ -algebras of local observables from higher prequantum bundles*, [arXiv:1304.6292](https://arxiv.org/abs/1304.6292)
- [FS] D. Fiorenza, U. Schreiber, *∞ -Chern-Simons theory*, <http://ncatlab.org/schreiber/show/infinity-Chern-Simons+theory>
- [FiSaScI] D. Fiorenza, H. Sati, U. Schreiber, *Twisted differential c-structures*
- [FSS12a] D. Fiorenza, H. Sati, U. Schreiber, *The E_8 -moduli 3-stack of the C-field*, [arXiv:1202.2455](https://arxiv.org/abs/1202.2455)
- [FSS12b] D. Fiorenza, H. Sati, U. Schreiber, *Multiple M5-branes, String 2-connections, and 7d nonabelian Chern-Simons theory*, [arXiv:1201.5277](https://arxiv.org/abs/1201.5277)
- [FSS12c] D. Fiorenza, H. Sati, U. Schreiber, *Higher extended cup-product Chern-Simons theories*, [arXiv:1207.5449](https://arxiv.org/abs/1207.5449)
- [FSS13a] D. Fiorenza, H. Sati, U. Schreiber, *A higher stacky perspective on Chern-Simons theory*, in Damien Calaque et al. (eds.) *Mathematical Aspects of Quantum Field Theories* Springer 2014 [arXiv:1301.2580](https://arxiv.org/abs/1301.2580)
- [FSS13b] D. Fiorenza, H. Sati, U. Schreiber, *Super Lie n -algebra extensions, higher WZW models and super p -branes with tensor multiplet fields*, [arXiv:1308.5264](https://arxiv.org/abs/1308.5264)

- [FP89] R. Floreanini, R. Percacci, *Higher dimensional abelian Chern-Simons theory*, Phys. Lett. **B 224** (1989), 291–294.
- [Fr95] D. Freed, *Classical Chern-Simons theory Part I*, Adv. Math., 113 (1995), 237–303
and
Classical Chern-Simons theory, part II, Houston J. Math., 28 (2002), pp. 293–310 and *Remarks on Chern-Simons theory*, Bulletin (New Series) of the AMS, Volume 46, Number 2, (2009)
- [Fr99] D. Freed, *Five lectures on supersymmetry*, American Mathematical Society, Providence, RI, 1999.
- [Fr00] D. Freed, Dirac charge quantization and generalized differential cohomology, In *Surveys in differential geometry*, Surv. Differ. Geom., VII, pages 129–194. Int. Press, Somerville, MA (2000)
arXiv:hep-th/0011220
- [Fr12a] D. Freed, *Twisted K-theory and orientifolds*, lecture at *K-Theory and Quantum Fields*, Erwin Schrödinger institute (June 2012)
- [Fr12b] D. Freed, *4-3-2 8-7-6*, talk at *Aspects of Topology*, Oxford, Dec 2012,
<https://people.maths.ox.ac.uk/tillmann/ASPECTSfreed.pdf>
- [FrHo00] D. Freed, M. Hopkins *On Ramond-Ramond fields and K-theory*, Journal of High Energy Physics 0005 (2000) 044
- [FHT05] D. Freed, M. Hopkins, C. Teleman, Loop Groups and Twisted K-Theory II, J. Amer. Math. Soc. 26 (2013), 595-644, arXiv:math/0511232
- [FHT07] D. Freed, M. Hopkins, C. Teleman, *Consistent Orientation of Moduli Spaces*, arXiv:0711.1909
- [FHLT09] D. Freed, M. Hopkins, J. Lurie, C. Teleman, *Topological quantum field theories from compact Lie groups*, in *A Celebration of the Mathematical Legacy of Raoul Bott*, AMS, (2010) arXiv:0905.0731
- [FrMo06] D. Freed, G. Moore, *Setting the quantum integrand of M-theory*, Communications in mathematical physics, Volume 263, Number 1 (2006)
- [FrQu93] D. Freed, F. Quinn, *Chern-Simons Theory with Finite Gauge Group*, Commun. Math. Phys. 156:435-472, 1993
- [FSS10] D. Fiorenza, U. Schreiber, J. Stasheff. *Čech-cocycles for differential characteristic classes*, Advances in Theoretical and Mathematical Physics, Volume 16 Issue 1 (2012) arXiv:1011.4735
- [Fl60] S. Flügge, *Principles of Classical Mechanics and Field Theory*, Encyclopedia of Physics III/I, Springer 1960
- [FoRo05] M. Forger, S. Romero, *Covariant Poisson Brackets in Geometric Field Theory*, Commun. Math. Phys. 256 (2005) 375-410, arXiv:math-ph/0408008
- [Fra] T. Frankel, *The Geometry of Physics – An introduction*, Cambridge University Press,
- [FrWi99] D. Freed, E. Witten, *Anomalies in String Theory with D-Branes*, Asian J. Math. **3** (1999) 819,
arXiv:hep-th/9907189
- [FuRuSc] J. Fuchs, I. Runkel, C. Schweigert, *TFT construction of RCFT correlators I – V*, arXiv:hep-th/0204148, arXiv:hep-th/0306164, arXiv:hep-th/0403157, arXiv:hep-th/0412290, arXiv:hep-th/0503194
- [Gaj97] P. Gajer. Geometry of Deligne cohomology. *Invent. Math.*, 127(1):155–207 (1997)
- [Gam10] N. Gambino, *Weighted limits in simplicial homotopy theory*, Journal of Pure and Applied Algebra vol 214 (7) (2010) <http://www.crm.es/Publications/08/Pr790.pdf>

- [GaNi85] S. Gates, Jr., H. Nishino, *New $D = 10$, $N = 1$ supergravity coupled to Yang-Mills supermultiplet and anomaly cancellations*, Phys. Lett. **B157** (1985) 157
- [Ga88] K. Gawedzki, *Topological actions in two-dimensional quantum field theories*, Nonperturbative quantum field theory (Cargese, 1987), 101141, NATO Adv. Sci. Inst. Ser. B Phys., 185, Plenum, New York, 1988.
- [Ga00] K. Gawedzki, *Conformal field theory: a case study*, in Y. Nutku, C. Saclioglu, T. Turgut (eds.) *Frontier in Physics* 102, Perseus Publishing (2000) [hep-th/9904145](#)
- [Ga04] A. Alekseev, V. Schomerus, *D-branes in the WZW model*, Phys. Rev. D60:061901 (1999) [arXiv:hep-th/9812193](#)
 K. Gawedzki, N. Reis, *WZW branes and gerbes*, Rev.Math.Phys. 14 (2002) 1281-1334, [arXiv:hep-th/0205233](#)
 K. Gawedzki, *Abelian and non-Abelian branes in WZW models and gerbes*, Commun.Math.Phys. 258 (2005) 23-73, [arXiv:hep-th/0406072](#)
- [Ge09] E. Getzler. Lie theory for nilpotent L_∞ -algebras. *Ann. of Math. (2)*, 170(1):271–301, (2009)
- [GGK02] V. Ginzburg, V. Guillemin, Y. Karshon, *Moment maps, cobordisms, and Hamiltonian group actions* AMS (2002)
- [Go03] T. Goodwillie, *Calculus III: Taylor Series*, Geom. Topol. 7(2003) 645-711 [arXiv:math/0310481](#)
- [GoTe00] K. Komi, Y. Terashima, *A fiber integration formula for the Smooth Deligne Cohomology*, International Mathematics Research Notices, No 13 (2000)
- [GrSch84] M. Green, J. Schwarz, *Covariant description of superstrings*, Phys. Lett. **B136** (1984), 367–370.
- [GHV73] W. Greub, S. Halperin, R. Vanstone, *Connections, Curvature, and Cohomology*, Academic Press (1973)
- [Gir71] J. Giraud *Cohomologie non-abélienne*, Springer (1971)
- [GoJa99] P. Goerss, J. Jardine, *Simplicial homotopy theory*, volume 174 of *Progress in Mathematics*. Birkhäuser Verlag, Basel (1999)
- [GMPW08] M. Graña, R. Minasian, M. Petrini, D. Waldram, *T-duality, Generalized Geometry and Non-Geometric Backgrounds*, JHEP 0904:075, (2009) [arXiv:0807.4527](#)
- [GrSc] M. Green, J. Schwarz, *Anomaly cancellation in supersymmetric $D = 10$ gauge theory and superstring theory*, Phys. Lett. **B149** (1984) 117.
- [Gr92] D. Gross, *Gauge theory – Past, present, and future?*, Chines Journal of Physics, Vol. 30, No 7, 1992
- [GuTh08] E. Guadagnini, F. Thuillier, *Deligne-Beilinson cohomology and abelian links invariants*, Sigma 4 (2008), 078, 30, [arXiv:0801.1445](#)
- [GK08] S. Gukov, E. Witten, *Branes and Quantization*, Adv. Theor. Math. Phys. 13 (2009) 1-73, [arXiv:0809.0305](#)
- [Ha06] E. Hawkins, *A groupoid approach to quantization*, J. Symplectic Geom. Volume 6, Number 1 (2008), 61-125. [arXiv:math.SG/0612363](#)
- [He1841] G. Hegel, *Wissenschaft der Logik*, Duncker und Humboldt, Berlin 1841
- [Hél11] F. Hélein, *Multisymplectic formalism and the covariant phase*, (2011), [arXiv:1106.2086](#)

- [HHé02] F. Hélein, *Hamiltonian formalisms for multidimensional calculus of variations and perturbation theory*, contribution to *Conference on Noncompact Variational Problems and General Relativity* in Honor of H. Brezis and F.E. Browder, Oct. 2001, arXiv:math-ph/0212036
- [HeSh10] S. Hellerman, E. Sharpe, *Sums over topological sectors and quantization of Fayet-Iliopoulos parameters*, arXiv:1012.5999
- [HeMe85] M. Henneaux and L. Mezincescu, *A Sigma model interpretation of Green-Schwarz covariant superstring action*, Phys. Lett. **B152** (1985), 340–342.
- [HeTe92] M. Henneaux, C. Teitelboim, *Quantization of gauge systems* Princeton University Press, 1992
- [Hen08] A. Henriques, *Integrating L_∞ -algebras* Compos. Math., 144(4) (2008), arXiv:math/0603563
- [Hin97] V. Hinich. *Descent of Deligne groupoids*, Internat. Math. Res. Notices, (5):223–239, 1997.
- [Hi11] N. Hitchin, *Lectures on generalized geometry*, in *Geometry of special holonomy and related topics*, 79–124, Surv. Differ. Geom. **16**, Int. Press, Somerville, MA, 2011.
- [Hi12] N. Hitchin, *Generalized Geometry of Type B_n* , talk at *String-Math 2012*, <http://www.hcm.uni-bonn.de/events/eventpages/2012/string-math-2012/>
- [Hi1900] D. Hilbert, *Mathematical Problems*, Bulletin of the American Mathematical Society, vol. 8, no. 10 (1902), pp. 437-479.
Earlier publications (in the original German) appeared in
Göttinger Nachrichten, 1900, pp. 253-297,
and
Archiv der Mathematik und Physik, 3dser., vol. 1 (1901), pp. 44-63, 213-237.
- [H] P. Hirschhorn, *Overcategories and undercategories of model categories*
<http://www-math.mit.edu/~psh/undercat.pdf>
- [HoWi96] P. Horava and E. Witten, *Eleven-dimensional supergravity on a manifold with boundary*, Nucl. Phys. **B475** (1996) 94-114, arXiv:hep-th/9603142
- [HoWi95] P. Horava, E. Witten, *Heterotic and Type I string dynamics from eleven dimensions*, Nucl. Phys. B460 (1996) 506, arXiv:hep-th/9510209 and *Eleven dimensional supergravity on a manifold with boundary*, Nucl. Phys. B475 (1996) 94, arXiv:hep-th/9603142
- [Hö71] L. Hörmander, *Fourier Integral Operators I.*, Acta Math. 127 (1971)
- [Ho11] M. Hopkins, *Differential cohomology for general cohomology theories and one physical motivation*, talk at Simons Center Workshop on Differential Cohomology (2011)
<http://scgp.stonybrook.edu/archives/851>
- [HoSi05] M. Hopkins, I. Singer. *Quadratic functions in geometry, topology, and M-theory*, J. Differential Geom., 70(3):329–452, (2005)
- [Hor89] G. Horowitz, *Exactly solvable diffeomorphism invariant theories*, Commun. Math. Phys. 125, 417-437 (1989)
- [Hove99] M. Hovey. *Model categories*, Mathematical Surveys and Monographs, volume 63 American Mathematical Society, Providence, RI, (1999)
- [Huer11] J. Huerta, *Supersymmetry, Division Algebras, and Higher Gauge Theory*, PhD thesis (2011)
- [Hull07] C. Hull, *Generalised Geometry for M-Theory* JHEP 0707:079 (2007) arXiv:hep-th/0701203

- [HT94] C. Hull, P. Townsend, *Unity of Superstring Dualities*, Nucl. Phys. B438 : 109-137 (1995)
arXiv:hep-th/9410167
- [Hus94] D. Husemöller, *Fiber bundles*, Springer (1994)
- [Ig13] P. Iglesias-Zemmour, *Diffeology*, Mathematical Surveys and Monographs, AMS (2013)
<http://www.umpa.ens-lyon.fr/~iglesias/Site/The+Book.html>
- [Ike03] N. Ikeda, *Chern-Simons Gauge Theory coupled with BF Theory*, Int. J. Mod. Phys. A18 (2003)
2689-2702, hep-th/0203043
- [Il72] L. Illusie, *Complexe cotangent et déformations, I*, SLNM **229** Springer-Verlag (1972)
- [Il72] L. Illusie, *Complexe cotangent et déformations, II*, SLNM **283**, Springer-Verlag (1972)
- [Jard87] J.F. Jardine, *Simplicial presheaves*, Journal of Pure and Applied Algebra, 47 (1987), 35-87
- [Ja96] J.F. Jardine, *Boolean localization, in practice* Doc. Math. 1 (1996), 245-275.
- [JaLu04] J.F. Jardine, Z. Luo, Higher order principal bundles, K-theory 0681 (2004)
- [Joh02] P. Johnstone. *Sketches of an Elephant: A Topos Theory Compendium*, Oxford Logic Guides, volume 43,44, Clarendon Press, 2002.
- [JohMo89] P. Johnstone, I. Moerdijk, *Local maps of toposes*, Proc. London Math. Soc. s3-58(2) (1989)
- [Jo02] A. Joyal, *Quasi-categories and Kan complexes*, Journal of Pure and Applied Algebra 175 (2002), 207-222.
- [Jo08a] A. Joyal, *Theory of quasi-categories and its applications*, lectures at *Simplicial Methods in Higher Categories*, Barcelona, 2008,
<http://mat.uab.cat/~kock/crm/hocat/advanced-course/Quadern45-2.pdf>
- [Jo08b] A. Joyal, *Notes on Logoi*, 2008 <http://www.math.uchicago.edu/~may/IMA/JOYAL/Joyal.pdf>
- [JoyMo94] A. Joyal, I. Moerdijk, *A completeness theorem for open maps*, Annals of Pure and Applied Logic **70**, Issue 1, (1994), p. 51-86
- [KaKrMi87] G. Kainz, G. Kriegl, P. Michor, *C^∞ -from the functional analytic point of view* Journal of pure and applied algebra, 46 (1987)
- [KaVa10] A. Kahle, A. Valentino, *T-duality and differential K-theory*, arXiv:0912.2516
- [KaSt08] H. Kajiura, J. Stasheff, *Homotopy algebra of openclosed strings*, Geometry and Topology Monographs 13 (2008) 229259, arXiv:0606283
- [Ka99] A. Kapustin, *D-branes in a topologically nontrivial B-field*, Adv. Theor. Math. Phys. 4, no. 1, pp. 127154 (2000), arXiv:hep-th/9909089
- [KaSa10a] A. Kapustin and N. Saulina, *Topological boundary conditions in abelian Chern-Simons theory*, Nucl. Phys. **B845** (2011), 393-435, arXiv:1008.0654
- [KaSa10b] A. Kapustin and N. Saulina, *Surface operators in 3d Topological Field Theory and 2d Rational Conformal Field Theory*, in: U. Schreiber, H. Sati (eds.), *Mathematical Foundations of Quantum Field and Perturbative String Theory*, Proc. Symp. Pure Math., vol. 83, AMS (2011) arXiv:1012.0911
- [Ka10] A. Kapustin, *Topological Field Theory, Higher Categories, and Their Applications*, Proceedings of ICM 2010, arXiv:1004.2307

- [Ke82] M. Kelly, *Basic Concepts of Enriched Category Theory*, Cambridge University Press, Lecture Notes in Mathematics, 64, 1982, Republished in: *Reprints in Theory and Applications of Categories*, No. 10 (2005) pp. 1-136
- [Kir04] A. Kirillov, *Lectures on the orbit method*, Graduate studies in mathematics, volume 64, American Math. Soc. (2004)
- [Kil89] Killingback, *World-sheet anomalies and loop geometry*, Nuclear Physics B Volume 288, 1987, Pages 578-588
- [Kock86] A. Kock, *Convenient vector spaces embed into the Cahiers topos*, Cahiers de Topologie et Géométrie Différentielle Catégoriques, tome 27 no. 1 (1986), p. 3-17
Corrigendum and addenda in A. Kock, G. Reyes, Cahiers de Topologie et Géométrie Différentielle Catégoriques, tome 28, no. 2 (1987), p 99-110,
http://www.numdam.org/item?id=CTGDC_1987__28_2_99_0
- [Kock06] A. Kock, *Synthetic Differential Geometry* Cambridge University Press, London Math. Society Lecture Notes Series No. 333 (2006)
- [Kock10] A. Kock, *Synthetic Geometry of Manifolds*, Cambridge Tracts in Mathematics, 180 (2010)
- [KonSch00] A. Konechny, A. Schwarz, *On $(k \oplus l|q)$ -dimensional supermanifolds*, in J. Wess and V. Akulov (eds.) *Supersymmetry and Quantum Field Theory* (D. Volkov memorial volume) Lecture Notes in Physics, 509 Springer-Verlag (1998) [arXiv:hep-th/9706003](https://arxiv.org/abs/hep-th/9706003)
also published as: *Theory of $(k \oplus q|l)$ -dimensional supermanifolds*, Sel. math., New ser. 6 (2000) 471 - 486
- [Kol1] L. Kong, *Conformal field theory and a new geometry*, in H. Sati, U. Schreiber (eds.), *Mathematical Foundations of Quantum Field and Perturbative String Theory*, Proc. Symp. in Pure Math. vol 83, AMS, 2011, [arXiv:1107.3649](https://arxiv.org/abs/1107.3649)
- [Kon03] M. Kontsevich, *Deformation quantization of Poisson manifolds*, Lett. Math. Phys. 66 (2003), no. 3, 157216, [arXiv:q-alg/9709040](https://arxiv.org/abs/q-alg/9709040)
- [Kos70] B. Kostant, *Quantization and unitary representations*, in *Lectures in modern analysis and applications III*, Lecture Notes in Math. 170 (1970), Springer Verlag, 87208
- [KS05] I. Kriz and H. Sati, *Type IIB string theory, S-duality and generalized cohomology*, Nucl. Phys. **B715** (2005) 639–664, [arXiv:hep-th/0410293](https://arxiv.org/abs/hep-th/0410293)
- [LaMa95] T. Lada, M. Markl. *Strongly homotopy Lie algebras*, Comm. in Algebra, pages 2147–2161, 1995. [hep-th/9406095](https://arxiv.org/abs/hep-th/9406095) .
- [La09] K. Laine, *Geometric and topological aspects of Type IIB D-branes* , Master thesis, (2009)
- [LX03] C. Laurent-Gengoux, P. Xu, *Quantization of pre-quasi-symplectic groupoids and their Hamiltonian spaces* in *The Breadth of Symplectic and Poisson Geometry*, Progress in Mathematics, 2005, Volume 232, 423-454 [arXiv:math/0311154](https://arxiv.org/abs/math/0311154)
- [LaMi89] H. Lawson. M.-L. Michelson, *Spin Geometry*, Princeton University Press, Princeton, NJ, (1989)
- [Law65] *An elementary theory of the category of sets*, Proceedings of the National Academy of Science of the U.S.A 52, 1506-1511 (1965), reprinted in Reprints in Theory and Applications of Categories, No. 11 (2005) pp. 1-35,
- [Law67] W. Lawvere, *Categorical dynamics*, lecture in Chicago, 1967,
http://www.mat.uc.pt/~ct2011/abstracts/lawvere_w.pdf

- [Law97] W. Lawvere, *Toposes of laws of motion*, talk in Montreal, 1997
<http://www.acsu.buffalo.edu/~wlawvere/ToposMotion.pdf>
- [Law98] W. Lawvere, *Outline of synthetic differential geometry*, lecture in Buffalo, 1998,
<http://ncatlab.org/nlab/files/LawvereSDGOutline.pdf>
- [Law91] W. Lawvere *Some Thoughts on the Future of Category Theory* in A. Carboni, M. Pedicchio, G. Rosolini (eds.), *Category Theory*, Proceedings of the International Conference held in Como, Lecture Notes in Mathematics 1488, Springer (1991),
<http://ncatlab.org/nlab/show/Some+Thoughts+on+the+Future+of+Category+Theory>
- [Law06] W. Lawvere, *Adjointness in foundations*, Reprints in Theory and Applications of Categories, No. 16, 2006, pp. 116.
- [Law07] W. Lawvere, *Axiomatic cohesion*, Theory and Applications of Categories, Vol. 19, No. 3, (2007) pp. 4149.
- [Len85] H. Lenstra, *Galois theory for schemes*, Mathematisch Instituut Universiteit van Amstredam,
<http://websites.math.leidenuniv.nl/algebra/GSchemes.pdf>
- [L-Topos] J. Lurie, *Higher topos theory*, Annals of Mathematics Studies, volume 170, Princeton University Press, Princeton, NJ, (2009)
- [L-Cat] J. Lurie, $(\infty, 2)$ -Categories and the Goodwillie Calculus, arXiv:0905.0462
- [L-TFT] J. Lurie, *On the classification of topological field theories*, Current Developments in Mathematics, Volume 2008 (2009), 129-280
- [L-Alg] J. Lurie, *Higher algebra*, (2011)
<http://www.math.harvard.edu/~lurie/papers/higheralgebra.pdf>
- [L-Geo] J. Lurie, *Structured Spaces*, (2009) arXiv:0905.0459
- [L-DGeo] J. Lurie, *Notes on crystals and algebraic \mathcal{D} -modules*,
[http://www.math.harvard.edu/~gaitsgde/grad_2009/SeminarNotes/Nov17-19\(Crystals\).pdf](http://www.math.harvard.edu/~gaitsgde/grad_2009/SeminarNotes/Nov17-19(Crystals).pdf)
- [L-Lie] J. Lurie, *Formal moduli problems*,
<http://www.math.harvard.edu/~lurie/papers/DAG-X.pdf>
- [Mac87] K. Mackenzie, *Lie groupoids and Lie algebroids in differential geometry*, London Mathematical Society Lecture Note Series, 124. Cambridge University Press, Cambridge, 1987. xvi+327
- [Mac88] K. Mackenzie, *On extensions of principal bundles*, Annals of Global Analysis and Geometry Volume 6, Number 2 (1988)
- [Mac00] M. Mackaay, *Spherical 2-categories and 4-manifold invariants*, Adv. Math. 153 (2000), no. 2, 353390. arXiv:math/9805030
- [MacMoe92] S. MacLane, I. Moerdijk, *Sheaves in Geometry and Logic*, New York, 1992
- [Mah13] S. Mahanta, *Higher nonunital Quillen K^\times -theory, KK-dualities, and applications to topological T-duality*
<http://wwwmath.uni-muenster.de/u/snigdhayan.mahanta/papers/KQ.pdf>,
<http://wwwmath.uni-muenster.de/u/snigdhayan.mahanta/papers/KKTD.pdf>
- [Mald97] J. Maldacena *The Large N Limit of Superconformal Field Theories and Supergravity*, Adv. Theor. Math. Phys. 2:231-252 (1998), arXiv:hep-th/9711200

- [ML74] P. Martin-Löf, *An intuitionistic theory of types*, in H. E. Rose, J. C. Shepherdson (eds.), *Logic Colloquium* (1973), North-Holland, 1974,
<http://citeseerx.ist.psu.edu/viewdoc/summary?doi=10.1.1.131.926>
- [MaPo07] J. Martins, T. Porter, *On Yetter's invariants and an extension of the Dijkgraaf-Witten invariant to categorical groups*, *Theory and Applications of Categories*, Vol. 18, (2007), No. 4, pp 118-150.
- [May67] P. May, *Simplicial objects in algebraic topology*, University of Chicago Press (1967)
- [May99] P. May, *A concise course in algebraic topology*, University of Chicago Press (1999),
<http://www.math.uchicago.edu/~may/CONCISE/ConciseRevised.pdf>
- [MaSi07] J. May, J. Sigurdsson, *Parametrized Homotopy Theory*, *Math Surv. and Monog.* 132, AMS (2007)
- [Me05] A. Carey, B.-L. Wang, *Fusion of symmetric D-branes and Verlinde rings* *Commun.Math.Phys.* 277:577-625 (2008) [arXiv:math-ph/0505040](https://arxiv.org/abs/math-ph/0505040)
 E. Meinrenken *On the quantization of conjugacy classes*, *Enseign. Math.* (2) 55 (2009), no. 1-2, 33-75, [arXiv:0707.3963](https://arxiv.org/abs/0707.3963)
- [Mic87] J. Mickelsson, *Kac-Moody groups, topology of the Dirac determinant bundle, and fermionization*, *Commun. Math. Phys.* **110** (1987), no. 2, 173-183
- [MoMr03] , I. Moerdijk, J. Mrčun, *Introduction to foliations and Lie groupoids*, Cambridge (2003)
- [MoPr97] I. Moerdijk, D. Pronk, *Orbifolds, sheaves and groupoids*, *K-theory* 12 (1997),
 I. Moerdijk, *Orbifolds as Groupoids: an Introduction*, [arXiv:math.DG/0203100](https://arxiv.org/abs/math.DG/0203100)
- [MoVe00] I. Moerdijk, J. Vermeulen, *Relative compactness conditions for toposes*, AMS (2000),
<http://igitur-archive.library.uu.nl/math/2001-0702-142944/1039.pdf>
- [Mol84] V. Molotkov. *Infinite-dimensional \mathbb{Z}_2^k -supermanifolds*, ICTP preprints, IC/84/183 (1984)
- [Mur96] M. K. Murray *Bundle Gerbes* *J. London Math. Soc.* (2) **54** (1996) no. 2, 403-416.
- [MuSi03] M. Murray, M. Singer, *Gerbes, Clifford modules and the index theorem*, *Annals of Global Analysis and Geometry*, Volume 26, Number 4, 355-367, [arXiv:math/0302096](https://arxiv.org/abs/math/0302096)
- [MuSt03] M. Murray and D. Stevenson, *Higgs fields, bundle gerbes and string structures*, *Commun. Math. Phys.* **243** (2003) 541-555,
- [Na06] V.P. Nair, *The Matrix Chern-Simons One-form as a Universal Chern-Simons Theory*, *Nucl.Phys.B*750:289-320 (2006)
- [Ni83] P. van Nieuwenhuizen, *Free graded differential superalgebras*, *Lect. Notes in Phys.* **180**, 228-245, Springer-Verlag, (1983).
- [NSW11] T. Nikolaus, C. Sachse, C. Wockel, *A smooth model for the String group*, [arXiv:1104.4288](https://arxiv.org/abs/1104.4288)
- [NSS12a] T. Nikolaus, U. Schreiber, D. Stevenson, *Principal ∞ -bundles – General theory*, [arXiv:1207.0248](https://arxiv.org/abs/1207.0248)
- [NSS12b] T. Nikolaus, U. Schreiber, D. Stevenson, *Principal ∞ -bundles – Presentations*, [arXiv:1207.0249](https://arxiv.org/abs/1207.0249)
- [NSS12c] T. Nikolaus, U. Schreiber, D. Stevenson, *Principal ∞ -bundles – Examples and applications*
- [NW11a] T. Nikolaus, K. Waldorf, *Four equivalent versions of non-abelian gerbes*,
[arXiv:1103.4815](https://arxiv.org/abs/1103.4815)
- [NW11b] T. Nikolaus, K. Waldorf, *Lifting Problems and Transgression for Non-Abelian Gerbes*,
[arXiv:1112.4702](https://arxiv.org/abs/1112.4702)

- [nLab:tangent cohesion] nLab, *tangent cohesive $(\infty, 1)$ -topos*,
[http://ncatlab.org/nlab/show/tangent+cohesive+\(infinity,1\)-topos](http://ncatlab.org/nlab/show/tangent+cohesive+(infinity,1)-topos)
- [Nui13] J. Nuiten, *Cohomological quantization of local prequantum boundary field theory*, MSc, August 2013
<http://ncatlab.org/schreiber/show/master+thesis+Nuiten>
- [Pa61] R. Palais, *On the existence of slices for actions of non-compact Lie groups*, Annals of Mathematics, vol. 73, no 2 (1961),
<http://vmm.math.uci.edu/ExistenceOfSlices.pdf>
- [PaSh05] T. Pantev, E. Sharpe, *String compactifications on Calabi-Yau stacks*, Nucl.Phys. B733 (2006) 233-296, [arXiv:0502044](https://arxiv.org/abs/0502044)
- [Paug11] F. Paugam, *Homotopical Poisson reduction of gauge theories*, in H. Sati, U. Schreiber (eds.), *Mathematical foundations of quantum field theory and perturbative string theory*, Proceedings of Symposia in Pure Mathematics, AMS (2011), [arxiv:1106.4955](https://arxiv.org/abs/1106.4955)
- [Po99] J. Polchinski, *M-theory and the light cone*, Prog. Theor. Phys. Suppl. **134** (1999), 158–170, [hep-th/9903165](https://arxiv.org/abs/hep-th/9903165)
- [Po01] J. Polchinski, *String theory*, Cambridge University Press, Cambridge, (2001).
- [PoWa05] P. Polesello, I. Waschkie, *Higher monodromy, Homology, Homotopy and Applications*, Vol. 7(2005), No. 1, pp. 109-150
- [Por] T. Porter *The crossed menagerie*, <http://ncatlab.org/timporter/files/menagerie10.pdf>
- [PrVi92] J. Preskill and A. Vilenkin, *Decay of metastable topological defects*, Phys. Rev. **D47** (1993), 2324–2342, [arXiv:hep-ph/9209210](https://arxiv.org/abs/hep-ph/9209210)
- [Pr10] J. Pridham, *Unifying derived deformation theories*, Adv. Math. **224** (2010), no.3, 772–826, [arXiv:0705.0344](https://arxiv.org/abs/0705.0344)
- [RaSch81] T. Ratiu, R. Schmid, *The differentiable structure of three remarkable diffeomorphism groups*, Math. Z. 177, 81-100 (1981)
- [Redd06] C. Redden, *Canonical metric connections associated to string structures* PhD Thesis (2006) <https://www.math.sunysb.edu/~redden/Thesis.pdf>
- [Re05] C. Rezk, *Toposes and homotopy toposes*, lectures at UIUC (2005)
<http://www.math.uiuc.edu/~rezk/homotopy-topos-sketch.pdf>
- [RoKo04] A. Rosenberg, M. Kontsevich, , *Noncommutative spaces*, (2004) MPI-2004-35
- [RoSc08] D. Roberts, U. Schreiber, *The inner automorphism 3-group of a strict 2-group* Journal of Homotopy and Related Structures, vol. 3(1), 2008, [arXiv:0708.1741](https://arxiv.org/abs/0708.1741)
- [RoSt12] D. Roberts, D. Stevenson, *Simplicial principal bundles in parametrized spaces* (2012) [arXiv:1203.2460](https://arxiv.org/abs/1203.2460)
D. Stevenson, *Classifying theory for simplicial parametrized groups* (2012) [arXiv:1203.2461](https://arxiv.org/abs/1203.2461)
- [Rog10] C. Rogers, *L_∞ -algebras from multisymplectic geometry*, Lett. Math. Phys. **100** (2012), 29–50, [arXiv:1005.2230](https://arxiv.org/abs/1005.2230).
- [Rog11a] C. L. Rogers, *Higher symplectic geometry*, PhD thesis (2011) [arXiv:1106.4068](https://arxiv.org/abs/1106.4068)
- [Rog11b] C. L. Rogers, *Higher geometric quantization*, talk at Higher Structures in Göttingen (2011), http://www.crcg.de/wiki/Higher_geometric_quantization

- [Rom05] N. Román-Roy, *Multisymplectic Lagrangian and Hamiltonian Formalisms of Classical Field Theories*, SIGMA 5 (2009), 100, arXiv:math-ph/0506022
- [Ros89] J. Rosenberg, *Continuous-trace algebras from the bundle theoretic point of view*. J. Austral. Math. Soc. Ser. A 47 (1989), no. 3, 368-381.
- [Roy02] D. Roytenberg, On the structure of graded symplectic supermanifolds and Courant algebroids, in *Quantization, Poisson Brackets and Beyond*, Theodore Voronov (ed.), *Contemp. Math.*, Vol. 315, Amer. Math. Soc., Providence, RI, 2002
- [Roy06] D. Roytenberg, AKSZ-BV Formalism and Courant Algebroid-induced Topological Field Theories, *Lett.Math.Phys.*79:143-159 (2007)
- [Roy10] D. Roytenberg, *Differential graded manifolds and associated stacks*, <http://sites.google.com/site/dmitryroytenberg/unpublished/dg-stacks-overview.pdf>
- [Sak99] M. Sakaguchi, *IIB-Branes and new spacetime superalgebras*, JHEP **0004** (2000), 019, arXiv:hep-th/9909143
- [SaSe85] A. Salam, E. Sezgin, *Anomaly freedom in chiral supergravities*, Phys. Scripta **32** (1985) 283.
- [Sa10a] H. Sati, *Geometric and topological structures related to M-branes*, Proc. Symp. Pure Math. 81 (2010), 181-236 arXiv:1001.5020
- [Sa10b] H. Sati, *Geometric and topological structures related to M-branes II, Twisted String- and String^c-structures*, J. Australian Math. Soc. 90 (2011), 93-10, arXiv:1007.5419
- [Sa10c] H. Sati, *Geometric and topological structures related to M-branes III, Twisted higher structures*, Int. J. Geom. Meth. Mod. Phys. 8 (2011), 1097-1116, arXiv:1008.1755
- [Sa10] H. Sati, *Duality and cohomology in M-theory with boundary*, J. Geom. Phys. **62** (2012), 1284–1297, arXiv:1012.4495
- [Sa11a] H. Sati, *Corners in M-theory*, J. Phys. **A 44** (2011), 255402, arXiv:1101.2793
- [Sa11b] H. Sati, *Twisted topological structures related to M-branes II: Twisted Wu and Wu^c structures*, arXiv:1109.4461
- [Sa12] H. Sati, *M-theory with framed corners and tertiary index invariants*, arXiv:1203.4179
- [SaSc11a] H. Sati, U. Schreiber (eds.), *Mathematical foundations of quantum field theory and perturbative string theory*, Proceedings of Symposia in Pure Mathematics, AMS (2011)
- [SaSc11b] H. Sati, U. Schreiber, *Survey of mathematical foundations of QFT and perturbative string theory*, in H. Sati, U. Schreiber (eds.) *Mathematical Foundations of Quantum Field Theory and Perturbative String Theory*, Proceedings of Symposia in Pure Mathematics, volume 83 AMS (2011), arXiv:1109.0955
- [SSSS08] H. Sati, U. Schreiber, Z. Škoda, and D. Stevenson, *Twisted differential nonabelian cohomology*, <http://ncatlab.org/schreiber/show/Twisted+Differential+Nonabelian+Cohomology>
- [SSS09a] H. Sati, U. Schreiber, J. Stasheff, *L_∞-connections*, In *Recent developments in QFT*, Birkhäuser (2009), arXiv:0801.3480
- [SSS09b] H. Sati, U. Schreiber, J. Stasheff, *Fivebrane structures*, *Rev. Math. Phys.*, 21(10):1197–1240 (2009)
- [SSS09c] H. Sati, U. Schreiber, J. Stasheff, *Twisted differential string- and fivebrane structures*, *Commun. Math. Phys.* 315 (2012), 169-213, arXiv:0910.4001

- [Scho10] C. Schommer-Pries, *Central extensions of smooth 2-groups and a finite-dimensional string 2-group*, arXiv:0911.2483
- [Sc07] U. Schreiber, *Quantum 2-States: Sections of 2-vector bundles*, talk at *Higher categories and their applications*, Fields institute (2007), <http://ncatlab.org/nlab/files/Schreiber2States.pdf>
- [Sc08] U. Schreiber, *AQFT from n-functorial QFT*, Commun. Math. Phys. **291** (2009), 357–401, arXiv:0806.1079
- [Sc09] U. Schreiber, *Background fields in twisted differential nonabelian cohomology*, talk at Oberwolfach Workshop *Strings, Fields, Topology* (2009), <http://ncatlab.org/schreiber/show/Background+fields+in+twisted+differential+nonabelian+cohomology>
- [Sc11] U. Schreiber, *Derived critical loci*, Seminar notes, Utrecht 2011 <http://http://ncatlab.org/schreiber/show/derived+critical+locus>
- [Sc12] U. Schreiber, *Twisted smooth cohomology in string theory*, Lectures at *ESI Program on K-Theory and Quantum Fields* (May 2012), <http://ncatlab.org/nlab/show/twisted+smooth+cohomology+in+string+theory>
- [Sc13a] U. Schreiber, *The geometry of physics* Lecture notes <http://ncatlab.org/nlab/show/geometry+of+physics>
- [Sc13b] U. Schreiber et. al., *Local prequantum field theory*, <http://ncatlab.org/schreiber/show/Local+prequantum+field+theory>
- [Sc13c] U. Schreiber, *Motivic quantization of local prequantum field theory* talk at GAP XI *Higher Geometry and Quantum Field Theory*, Pittsburgh, August 2013, <http://ncatlab.org/schreiber/show/Motivic+quantization+of+local+prequantum+field+theory>
- [Sc13d] U. Schreiber, *Synthetic quantum field theory*, talks 2013, <http://ncatlab.org/schreiber/show/Synthetic+Quantum+Field+Theory>
- [SSW05] U. Schreiber, C. Schweigert, K. Waldorf, *Unoriented WZW models and Holonomy of Bundle Gerbes*, Communications in Mathematical Physics, Volume 274, Issue 1 (2007), arXiv:0512283
- [ScSh12] U. Schreiber, M. Shulman *Quantum gauge field theory in Cohesive homotopy type theory*, Proceedings of *Quantum Physics and Logic 2012*, ncatlab.org/schreiber/show/Quantum+gauge+field+theory+in+Cohesive+homotopy+type+theory
- [ScWa07] U. Schreiber, K. Waldorf, *Parallel transport and functors*, J. Hom. Relat. Struct., 4, 187-244 (2009), arXiv:0705.0452
- [ScWa08] U. Schreiber, K. Waldorf, *Smooth 2-functors and differential forms*, Homology, Homotopy and Applications 13(1), 143-203 (2011) arXiv:0802.0663
- [ScWa08] U. Schreiber, K. Waldorf, *Connections on nonabelian gerbes and their holonomy*, Theory and Applications of Categories, Vol. 28, 2013, No. 17, pp 476-540, arXiv:0808.1923
- [ScSk10] U. Schreiber and Z. Škoda, *Categorified symmetries*, in B. Dragovich, Z. Rakić (eds), *Proceedings of the 5th Summer School of Modern Mathematical Physics*, SFIN, XXII Series A: Conferences, No A1, (2009), 397-424, arXiv:1004.2472
- [Schw84] A. Schwarz, *On the definition of superspace* Teoret. Mat. Fiz., Volume 60, Number 1 (1984)
- [ScWa] C. Schweigert, K. Waldorf, *Gerbes and Lie Groups*, in *Developments and Trends in Infinite-Dimensional Lie Theory*, Progress in Mathematics Volume 288, 2011, pp 339-364 arXiv:0710.5467

- [Se84] R. A. G. Seely, *Locally cartesian closed categories and type theory*, Math. Proc. Camb. Phil. Soc. (1984) 95
- [Seg70] G. Segal, *Cohomology of topological groups*, Symposia Mathematica, Vol IV (1970) p. 377
- [Seg73] G. Segal, *Configuration-Spaces and Iterated Loop-Spaces*, Inventiones math. 21, 213-221 (1973)
- [Sev01] P. Ševera, *Some title containing the words “homotopy” and “symplectic”, e.g. this one*, arXiv:math/0105080
- [Sez96] E. Sezgin, *The M-algebra*, Phys. Lett. **B 392** (1997), 323–331, hep-th/9609086
- [Sha97] R. Sharpe, *Differential Geometry Cartan’s Generalization of Klein’s Erlangen program* Springer (1997)
- [Shu07] M. Shulman, *Parametrized spaces model locally constant homotopy sheaves*, Topology and its Applications Volume 155, Issue 5, 15 (2008)
- [Shu11] M. Shulman, *Axiomatic cohesion in HoTT*, 2011
homotopytypetheory.org/2011/11/02/axiomatic-cohesion-in-hott/
- [SiTe] C. Simpson, C. Teleman *de Rham theorem for ∞ -stacks*
<http://math.berkeley.edu/~teleman/math/simpson.pdf>
- [Sn79] V. Snaith, *Algebraic Cobordism and K-theory*, Mem. Amer. Math. Soc. no 221 (1979)
- [Sou79] J. Souriau, *Groupes différentiels*, in *Differential Geometrical Methods in Mathematical Physics* (Proc. Conf., Aix-en-Provence/Salamanca, 1979), Lecture Notes in Math. 836, Springer, Berlin, 1980, pp. 91128.
- [Sou97] J.-M. Souriau, *Structure of dynamical systems - A symplectic view of physics*, Birkhäuser (1997)
- [SpRi12] B. Spitters, E. Rijke, *Orthogonal factorization systems in homotopy type theory*, Univalent Foundations Seminar, IAS, January 2012
uf-ias-2012.wikispaces.com/file/view/images.pdf/401765624/images.pdf
- [Sp08] D. Spivak, *Derived smooth manifolds*, PhD thesis (2008)
- [St08] A. Stacey, *Comparative Smoothology*, Theory and Applications of Categories, Vol. 25, 2011, No. 4, pp 64-117, arXiv:0802.2225
- [St63a] J. Stasheff, *A classification theorem for fiber spaces*, Topology 2 (1963) 239-246
- [St63b] J. Stasheff, *Homotopy associative H-spaces I, II*, Trans. Amer. Math. Soc. 108 (1963), 275312
- [Stee67] N. Steenrod, A convenient category of topological spaces *Michigan Math. J.* 14 (1967) 133152
- [Stel10] H. Stel, *∞ -Stacks and their function algebras*, master thesis (2010)
<http://nlab.mathforge.org/schreiber/show/master+thesis+Stel>
- [St01] D. Stevenson, *Bundle 2-gerbes*, PhD thesis, arXiv:math/0106018
- [St11] D. Stevenson, *Décalage and Kan’s simplicial loop group functor*, arXiv:1112.0474
- [Stol96] S. Stolz, A conjecture concerning positive Ricci curvature and the Witten genus *Math. Ann.* 304(4):785-800 (1996)
- [Stre04] R. Street, *Categorical and combinatorial aspects of descent theory* *Applied categorical structures* 12: 537-576, Kluwer (2004)

- [Su08] R. Sujatha, *Motives from a categorical point of view*, Lecture notes (2008)
<http://www.math.tifr.res.in/~sujatha/ihes.pdf>
- [Su77] D. Sullivan *Infinitesimal computations in topology*, Publications Mathématiques de l’IHÉS, 47 (1977)
- [Toë00] B. Toën, *Toward a Galoisian interpretation of homotopy theory*, [arXiv:math/0007157](https://arxiv.org/abs/math/0007157)
- [Toë06] B. Toën, *Affine stacks (Champs affines)*, Selecta mathematica (2006) vol. 12, no1, pp. 39-134
- [ToVe02] B. Toën, G. Vezzosi, *Segal topoi and stacks over Segal categories*, Proceedings of the Program *Stacks, Intersection theory and Non-abelian Hodge Theory*, MSRI, Berkeley, (2002), [arXiv:math.AG/0212330](https://arxiv.org/abs/math.AG/0212330).
- [ToVe05] B. Toën, G. Vezzosi, *HAG II, Geometric stacks and applications*, Memoirs of the AMS (2005)
- [Top01] F. Toppan, *On anomalies in classical mechanical systems*, Journal of Nonlinear Mathematical Physics Volume 8, Number 3 (2001), 518533
- [TXL04] J.-L. Tu, P. Xu, C. Laurent-Gengoux, *Twisted K-theory of differentiable stacks*, Ann. sc. de l’ENS (2004) Volume: 37, Issue: 6, page 841-910, [arXiv:math/0306138](https://arxiv.org/abs/math/0306138)
- [UFP13] Univalent Foundations Project, *Homotopy Type Theory Univalent Foundations of Mathematics*, Institute for Advanced Study, Princeton 2013,
<http://homotopytypetheory.org/book/>
- [VW95] C. Vafa, E. Witten, *A one-loop test of string duality*, Nucl. Phys. **B447** (1995) 261-270,
[arXiv:hep-th/9505053](https://arxiv.org/abs/hep-th/9505053)
- [Veri09] D. Verity, Relating descent notions, *Australian Category Seminar* at Macquarie University on Wednesday 27th of May 2009 <http://ncatlab.org/nlab/files/VerityDescent.pdf>
- [ViSh94] A. Vilenkin and E. Shellard, *Cosmic strings and other topological defects*, Cambridge University Press, Cambridge, 1994.
- [Vi11] C. Vizman, *Abelian extensions via prequantization*, Ann. of Global Analysis and Geometry, 39 (2011) 361-386, [arXiv:0910.3906](https://arxiv.org/abs/0910.3906)
- [Vor84] A. Voronov, *Maps of supermanifolds*, Teoret. Mat. Fiz., 60(1):4348 (1984)
- [Wal08] K. Waldorf, *Multiplicative Bundle Gerbes with Connection*, Differential Geom. Appl. 28(3), 313-340 (2010) [arXiv:0804.4835](https://arxiv.org/abs/0804.4835)
- [Wal09] K. Waldorf, *String connections and Chern-Simons theory*, (2009) [arXiv:0906.0117](https://arxiv.org/abs/0906.0117)
- [Wa08] B.-L. Wang, *Geometric cycles, index theory and twisted K-homology*, J. Noncommut. Geom. 2 (2008), no. 4, 497552, [arXiv:0710.1625](https://arxiv.org/abs/0710.1625)
- [We11] M. Wendt, *Classifying spaces and fibrations of simplicial sheaves*, J. Homotopy Relat. Struct. 6(1), 2011, pp. 1–38. (2010), [arXiv:1009.2930](https://arxiv.org/abs/1009.2930)
- [We71] A. Weinstein, *Symplectic manifolds and their lagrangian submanifolds*, Advances in Math. 6 (1971)
- [We83] A. Weinstein, *Lectures on Symplectic Manifolds*, volume 29 of CBMS Regional Conf. Series in Math. Amer. Math. Soc., 1983. third printing.
- [Wei89] A. Weinstein, *Symplectic groupoids, geometric quantization, and irrational rotation algebras in Symplectic geometry, groupoids, and integrable systems* Berkeley, (1989), 281290, Springer, New York, (1991)

- [WeXu91] A. Weinstein, P. Xu, *Extensions of symplectic groupoids and quantization*, Journal für die reine und angewandte Mathematik (1991) Volume 417
- [Wi87] E. Witten *Elliptic Genera And Quantum Field Theory*, Commun.Math.Phys. 109 525 (1987)
<http://projecteuclid.org/euclid.cmp/1104117076>
- [Wi89] E. Witten, *Chern-Simons theory and the Jones polynomial*, Commun. Math. Phys. 121 (3) (1989)
- [Wi96] E. Witten, *Five-brane effective action in M-Theory*, J. Geom. Phys. 22 (1997), no. 2, [hep-th/9610234](http://arxiv.org/abs/hep-th/9610234)
- [Wi97a] E. Witten, *On Flux Quantization In M-Theory And The Effective Action*, J.Geom.Phys.22:1-13 (1997), [arXiv:hep-th/9609122](http://arxiv.org/abs/hep-th/9609122)
- [Wi97b] E. Witten, *Five-Brane Effective Action In M-Theory*, Journal of Geometry and Physics Volume 22, Issue 2, (1997), [arXiv:hep-th/9610234](http://arxiv.org/abs/hep-th/9610234)
- [Wi98a] E. Witten, *Anti-de Sitter space and holography*, *Advances in Theoretical and Mathematical Physics* 2: 253291, (1998), [hep-th/9802150](http://arxiv.org/abs/hep-th/9802150)
- [Wi98b] E. Witten, *Magic, mystery, and matrix*, Notices Amer. Math. Soc. **45** (1998), no. 9, 1124–1129,
<http://www.sns.ias.edu/~witten/papers/mmm.pdf>
- [Wi98c] E. Witten, *AdS/CFT Correspondence And Topological Field Theory*, JHEP 9812:012,1998,
[arXiv:hep-th/9812012](http://arxiv.org/abs/hep-th/9812012)
- [Wi04] E. Witten, *Conformal Field Theory In Four And Six Dimensions* U. Tillmann (ed.), *Topology, geometry and quantum field theory* LMS Lecture Note Series (2004), [arXiv:0712.0157](http://arxiv.org/abs/0712.0157)
- [Wi09] E. Witten, *Geometric Langlands From Six Dimensions*, [arXiv:0905.2720](http://arxiv.org/abs/0905.2720)
- [Wi11] E. Witten, *Fivebranes and knots*, [arXiv:1101.3216](http://arxiv.org/abs/1101.3216)
- [Wock09] C. Wockel, *A generalization of Steenrod's approximation theorem* Arch. Math. (Brno), 45(2):95–104, (2009)
- [Yet88] D. Yetter, *Models for synthetic supergeometry*, Cahiers de Topologie et Géométrie Différentielle Catégoriques,, 29, 2 (1988)
- [Yet93] D. Yetter, *TQFTs from homotopy 2-types*, Journal of Knot Theory and its Ramifications 2 (1993), 113-123.
- [Zam10] M. Zambon, *L_∞ -algebras and higher analogues of Dirac structures and Courant algebroids* Journal of Symplectic Geometry, Vol. 10, no. 4 (2012), pp. 563-599. [arXiv:1003.1004](http://arxiv.org/abs/1003.1004)
- [Zan05] M. Bañados, R. Troncoso, J. Zanelli, *Higher dimensional Chern-Simons supergravity* Phys. Rev. D 54, 26052611 (1996), [arXiv:gr-qc/9601003](http://arxiv.org/abs/gr-qc/9601003)
and
J. Zanelli, *Lecture notes on Chern-Simons (super-)gravities* (2005), [arXiv:hep-th/0502193](http://arxiv.org/abs/hep-th/0502193)
- [Zan08] J. Zanelli, *Uses of Chern-Simons actions*, AIP Conf. Proc. **1031** (2008) 115–129, [arXiv:0805.1778](http://arxiv.org/abs/0805.1778)
- [Zi04] J. Zinn-Justin, *Path Integrals in Quantum Mechanics* Oxford University Press (2004)
- [Zu87] G. J. Zuckerman, *Action Principles and Global Geometry*, in S. T. Yau (ed.), *Mathematical Aspects of String Theory*, World Scientific, Singapore, 1987, pp. 259-284
<http://ncatlab.org/nlab/files/ZuckermanVariation.pdf>
- [Zw93] B. Zwiebach, *Closed string field theory: Quantum action and the B-V master equation*, Nucl.Phys. B390 (1993) 33

Index

- L_∞ -algebra, 119
 - L_∞ -algebra valued forms, 128
 - automorphism L_∞ -algebra, 120
 - characterization by dual dg-algebra, 120
 - Chevalley-Eilenberg algebra, 120
 - cocycle
 - homotopy fiber, 526
 - transgressive, 529
 - de Rham coefficients, 505
 - exponentiation/Lie integration, 498
 - super, 575
 - flat coefficients, 502
 - higher central extension, 525
 - invariant polynomials, 530
 - inner derivation L_∞ -algebra, 120
 - Lie 2-algebra, 120
 - Lie algebra, 119
 - line Lie n -algebra, 501
 - M2-brane Lie 3-algebra, 653
 - shifted central extension, 526
 - string Lie 2-algebra, 586
 - super, 575
 - super Poincaré Lie algebra, 653
 - supergravity Lie 6-algebra, 654
 - synthetic L_∞ -algebra valued forms, 559
- L_∞ -algebroid, 121, 552
 - definition, 552
 - simplicial presentation, 553
 - symplectic, 674
 - tangent Lie algebroid, 121
 - valued differential forms
 - Lie algebra valued, 97
 - valued forms, 127
- σ -model
 - AKSZ action functional, 722
 - AKSZ theory, 719
 - Courant σ -model, 726
 - higher dimensional abelian Chern-Simons theory, 727
 - ordinary Chern-Simons theory, 725
 - Poisson σ -model, 725
 - super p -branes, 736
 - Wess-Zumino-Witten type, 729
- 2-anafunctor, 79
- 2-gerbe, 346
- 2-group, 489
 - automorphism 2-group, 82
 - string 2-group, 584
- 2-plectic structure, 545
- action groupoid, 610
 - in introduction, 78
- AKSZ σ -models, 720
 - nonperturbative, 723
- anafunctor, 76
 - 2-anafunctor, 79
 - anafunctor, 76
 - as cocycles, 90
- anomaly cancellation
 - classical anomaly, 168
 - Freed-Witten-Kapustin anomaly, 209
 - Green-Schwarz anomaly, 604, 629, 649
 - dual, 604
 - in cohomological quantization, 766
 - in introduction, 20
 - open string on D-brane, 209
- Atiyah groupoid, 295
- atlas, 233
- base change, 272
- Bianchi identity, 125
 - for twisted string connections, 648
- Borel construction, 317, 468
- boundary field theory, 412, 421
- brane
 - brane bouquet, 745
 - D-brane
 - Freed-Witten-Kapustin anomaly, 209
 - in type IIA, 740
 - in type IIB, 742
 - D0-brane condensate, 740
 - M2-brane, 653
 - M5-brane, 743
 - old brane scan, 738
- bundle 2-gerbe
 - as principal 3-bundle, 87
- bundle gerbe, 78
 - as principal circle 2-bundle, 81
- bundle 2-gerbe
 - as principal 3-bundle, 87
- Cartan connection, 569
- category theory
 - ∞ -Yoneda lemma, 217
 - ∞ -adjunctions from derived Quillen adjunctions, 220
 - ∞ -presheaves, 217

- Kan complex, 65
- pasting law for ∞ -pullbacks, 233
- characteristic class
 - Bockstein homomorphism, 117
 - Chern class
 - first, 114
 - first differential, 634
 - second, smooth, 600
 - curvature, 373
 - Dixmier-Douady class, 115
 - general abstract, 304
 - in introduction, 112
 - obstruction class of central extension, 116
 - Pontryagin class
 - first, 118
 - first fractional, 583
 - second fractional, 595
 - Stiefel-Whitney
 - first and orientation structure, 581
 - second and spin structure, 582
 - Stiefel-Whitney class
 - first, 117
 - second, 117
 - third integral, 117
 - third integral, smooth, 637
- Chern-Simons element, 126, 529
- Chern-Simons functionals, 693
 - $(4k + 3)$ d functional, 709
 - 4d Yetter model, 708
 - 7-dimensional CS theory, 711
 - 7d CS theory
 - cup product of two 3d CS theories, 711
 - in 11d supergravity, 713
 - on string 2-connection fields, 712
 - AKSZ σ -models, 719
 - BF-theory, 707
 - Chern-Simons element, 126, 529
 - Courant σ -model, 726
 - Dijkgraaf-Witten theory, 706
 - equations of motion, 699
 - field theory, 694
 - gauge coupling of branes, 708
 - general abstract, 386
 - higher abelian CS functionals, 709
 - higher dimensional abelian Chern-Simons theory, 727
 - higher electric coupling terms, 710
 - in $\text{Smooth}\infty\text{Grpd}$, 536
 - intrinsic integration, 535
 - invariant polynomial, 528
 - ordinary Chern-Simons theory, 704, 725
 - Poisson σ -model, 725
 - string field theory, 718
 - topological Yang-Mills theory, 707
 - Wilson loops, 760
- Chern-Simons-functionals
 - Wilson loops, 207
- Chern-Weil homomorphism
 - general abstract, 383
 - overview, 134
 - presentation by Lie integration, 524
- Chern-Weil theory, 22
 - ∞ -Chern-Simons homomorphism, 383
- Chevalley-Eilenberg algebra, 120
- circle n -bundle with connection, 514
 - circle 3-bundle, 87
 - in introduction, 105
 - orientifold, 624
- classical field theory, 168
- classical mechanics, 140
- cohesive ∞ -topos, 250
 - contents, 243
 - infinitesimal cohesion, 261
 - definition, 262
 - site of definition, 264
 - structures, 427
 - models, 441
 - discrete cohesion, 450
 - Euclidean-topological cohesion, 456
 - smooth cohesion, 476
 - super cohesion, 571
 - synthetic-differential cohesion, 550
 - pointlike properties, 250
 - presentation over ∞ -cohesive site, 255
 - Sierpinski ∞ -topos, 443
 - site of definition, 255
 - structures in a cohesive ∞ -topos, 364
- cohesive site, 255
- cohomology, 304
 - Čech cocycles versus ∞ -stackification, 459
 - Čech cohomology, 470
 - cocycle, 304
 - cohomology localization, 561
 - de Rham (general abstract), 367
 - de Rham (ordinary), 496
 - equivariant cohomology, 304
 - general abstract, 304
 - group cohomology, 338
 - of discrete groups, 451
 - in petit ∞ -topos, 304
 - of L_∞ -algebroids, 564
 - of Lie groups, 562

- overview, 69
 - stable, 447
 - twisted differential cohomology, 602
- concordance, 354
- concrete cohesive ∞ -groupoid, 351
 - diffeological groupoid, 480
 - diffeological space, 480
- concrete objects, 352
 - concretification, 352
- connection
 - Cartan connection, 569
 - circle n -bundle with connection, 514
 - differential moduli, 518
 - fiber integration, 531
 - in introduction, 105
 - transgression, 531
 - curvature characteristic, 129
 - examples, 131
 - fivebrane 6-connection, 641
 - from Lie integration, 127, 128
 - gauge transformation, 129
 - general abstract, 383
 - holonomy
 - in introduction, 109
 - in $\text{Smooth}\infty\text{Grpd}$, 531
 - ordinary principal connection, 96, 131
 - simplicial presentation, 129
 - string 2-connection, 131, 648
 - twisted, 642
- coskeleton, 275
- crossed complex, 85
- curvature
 - Bianchi identity, 125
 - characteristic form (general abstract), 373
 - curvature 2-bundle, 96
 - curvature 2-form (general), 99
 - curvature 2-form (ordinary), 98
 - curvature 3-form, 99
 - curvature 4-form, 136, 647
- D-brane
 - charge in K-theory, 769
- de Rham space / de Rham ∞ -groupoid, 427
- defect field theory, 426
 - universal orbit method, 768
- descent
 - cocycles, 230
 - descent condition, 229
 - descent object, 228
 - for strict ∞ -groupoids, 232
 - from totalization, 229
 - for strict ∞ -groupoid valued presheaves, 232
- diffeological groupoid, 480
- diffeological space, 479
- differential cohomology
 - general abstract, 376
 - orientifold, 624
 - Hořava-Witten backgrounds, 666
 - overview, 110
 - smooth, 515
- differential form
 - on smooth space, 55
 - with values in L_∞ -algebroid, 127
 - with values in Lie algebra, 97
- differential string structure, 640
- Dold-Kan correspondence, 231
 - and cochain cohomology, 70
 - nonabelian, 231
- effective epimorphism, 233
- equivariant cohomology
 - in introduction, 304
- fiber sequence, 305
 - curvature, 515
 - loop space object, 300
- formal ∞ -groupoid, 440
- formally smooth morphism, 430
- formally étale morphism, 430
 - in $\text{Smooth}\infty\text{Grpd}$, 568
- fundamental ∞ -groupoid
 - general abstract, 353
 - singular simplicial complex, 451
- Galois theory, 359
- gauge theory
 - gravity as a gauge theory, 651
 - infinitesimal gauge transformation, 129
 - of heterotic supergravity, 649
 - overview, 18
 - supergravity as a gauge theory, 651
- geometric prequantization
 - ordinary, 540
 - smooth, 536
- geometric realization, 466
 - general abstract, 353
 - of smooth ∞ -groupoids, 484
 - of topological ∞ -groupoids, 466
- gerbe
 - 2-gerbe, 346
 - circle n -gerbe, 474, 475
 - cocycle, 83
 - EM n -gerbe, 346
 - over a topological space, 474

- relation to principal ∞ -bundle, 490
- gravitino, 655
- graviton, 655
- gravity, 651
- Green-Schwarz mechanism, 649
 - by parameterized WZW models, 682
 - dual, 604
- group
 - String^a, 600
 - String^{c₂}, 600
 - String^c, 599
 - 2-group, 489
 - automorphism 2-group, 82
 - crossed module, 81
 - from normal subgroup, 82
 - strict, 81
 - string 2-group, 82
 - 3-group
 - strict, 85
 - bare fivebrane ∞ -group, 595
 - circle Lie n -group, 481
 - of bisections, 294
 - smooth fivebrane 6-group, 596
 - smooth string 2-group, 584
 - strict, 85
- groupoid
 - Kan complex, 65
 - strict, 231
 - crossed complex, 85
- higher Spin^c-structures, 597
 - Spin^c itself as an example, 598
 - String^{c₂}, 599
- higher spin structures, 577
- holography
 - AdS₇/CFT₆, 713
 - 1d mechanics/2d Poisson-CS, 179, 686, 767
- holonomy
 - general abstract, 385
 - in Smooth ∞ Grpd, 531
 - with boundaries, 531
- homotopy
 - geometric, 353
 - overview, 72
- homotopy hypothesis theorem, 450
- infinitesimal cohesion, 261
 - definition, 262
 - infinitesimal neighbourhood site, 264
 - structures, 427
- infinitesimal cohesive neighbourhood, 262
- infinitesimal cohesive site, 264
- infinitesimal path ∞ -groupoid, 427
- invariant polynomial, 528
 - dg-algebra of invariant polynomials, 530
 - horizontal equivalence, 530
 - transgression via Chern-Simons element, 529
- jet ∞ -bundle, 429
- Kan complex, 65
- Kostant-Souriau-extension
 - L_∞ -extension, 540
 - general abstract, 399
- Lie algebroid
 - L_∞ -algebra, 119
 - L_∞ -algebroid, 552
 - formal ∞ -groupoid, 440
 - in SynthDiff ∞ Grpd, 552
 - simplicial presentation, 558
 - synthetic tangent Lie algebroid, 559
- Lie integration, 498
- locally constant ∞ -stack, 358
- loop space object, 300
- M-theory
 - brane bouquet, 747
 - M-theory super Lie algebra, 653
 - M2-brane, 653
 - M5-brane, 633, 743
 - M5-brane charge, 769
 - O9-plane charge, 769
- Maurer-Cartan form
 - general abstract, 372
 - on simplicial Lie group, 513
 - ordinary, 507
- Mayer-Vietoris sequence, 306
- object classifier
 - in ∞ Grpd, 456
- orbit method, 207
 - universal, 769
- orientation structure, 581, 582
- orientifold, 623
- parallel transport
 - flat ∞ -transport, 357
 - holonomy (general abstract), 386
 - holonomy (in Smooth ∞ Grpd), 535
 - in low dimensions, 95
- path
 - path ∞ -groupoid
 - Euclidean-topological, 470
 - smooth, 487

- paths
 - fundamental ∞ -groupoid, 250
 - infinitesimal path ∞ -groupoid, 427
 - path ∞ -groupoid, 355
 - path 2-groupoid, 99
 - path groupoid, 96
- Planck's constant, 532
- Poisson bracket
 - for pre-symplectic manifolds, 151
 - higher, 173
- Pontryagin class
 - first fractional
 - bare, 583
 - differential, 584
 - smooth, 584
 - second fractional
 - bare, 595
 - differential, 595
 - smooth, 595
- Postnikov decomposition, 274
- prequantum field theory, 406
 - boundary field theory, 412
 - defect field theory, 426
 - quantization, 763
- prequantum geometry
 - Examples, 679
 - general abstract, 393
 - smooth, 536
- principal ∞ -bundle
 - 2-bundle
 - $(\mathbb{Z} \rightarrow \mathbb{R})$ -2-bundles, 83
 - $\mathbf{B}\mathbb{Z}$ -2-bundles, 83
 - bundle 2-gerbe, 87
 - bundle gerbe, 81
 - characteristic classes
 - in introduction, 112
 - circle n -bundle with connection, 107, 514
 - circle 2-bundle, 80
 - construction from cocycle, 313
 - discrete, 452
 - gerbe, 490
 - in low dimensions, 74
 - ordinary smooth principal bundles, 489
 - principal 2-bundle, 82
 - principal 3-bundle
 - for strict 3-group, 89
 - simplicial presentation in introduction, 90
 - smooth, 489
 - topological, 470, 472
 - universal principal ∞ -bundle
 - in introduction, 90
 - smooth, in introduction, 76
 - topological, 463
 - universal principal 2-bundle, 90
- principal bundle
 - as smooth principal ∞ -bundle, 489
- pullback
 - pasting law, 233
 - presentation by homotopy limit, 235
- quantization, 763
- S-duality, 742
- sheaf, 228
 - ordinary sheaf, 229
- Sierpinski ∞ -Topos, 443
- simplicial principal bundle
 - discrete, 452
 - topological, 472
- smooth ∞ -groupoid
 - presentation by simplicial smooth manifolds, 227
 - symplectic, 676
- stack, 228
- string 2-connection, 648
- string 2-group, 583
 - as automorphisms of WZW term, 681
- string field theory, 719
- string group
 - bare ∞ -group, 583
 - smooth 2-group, 584
- string Lie 2-algebra, 132, 586
- string structure, 583
- structures in a cohesive ∞ -topos, 364
 - ∞ -bundles, 267
 - ∞ -gerbes, 345
 - Euclidean-topological, 474
 - ∞ -group actions, 326
 - ∞ -group representations
 - smooth, 491
 - topological, 465
 - \mathbb{A}^1 -homotopy, 365
 - \mathbb{R}^1 -homotopy, 469
- associated bundles, 326
 - 2-line bundle, 492
 - 2-vector bundle, 492
 - super 2-line bundle, 574
- Chern-Simons functional, 386
 - smooth, 536
- Chern-Weil homomorphism, 383
 - smooth, 524
 - synthetic-differential, 569
- codiscrete objects, 350
- cohesive ∞ -groups, 299

- Euclidean-topological, 463
- smooth, 480
- cohomology, 304
 - discrete, 451
 - Euclidean-topological, 470
 - of Lie groups, 488
 - smooth, 487
 - synthetic differential, 561
 - with constant coefficients, 488
- compact objects, 282
- concordance, 354
- concrete objects, 351
 - smooth, 479
- connected objects, 287
- critical locus, 438
- curvature characteristic forms, 372
 - smooth, 506
- de Rham cohomology, 367
 - smooth, 495
- de Rham space, 427
- de Rham theorem, 429
- differential cohomology, 373
 - differential moduli, 518
 - fiber integration, 531
 - smooth, 514
 - transgression, 531
- exponentiated ∞ -Lie algebras, 371
 - smooth, 498
 - synthetic differential, 552, 575
- extensions of cohesive ∞ -groups, 341
- flat ∞ -connections, 357
 - smooth, 493
- formal ∞ -groupoids, 440
- formally smooth/étale/unramified morphisms, 429
 - synthetic differential, 567
- Galois theory, 358
 - infinitesimal, 431
- geometric homotopy, 353
 - discrete, 450
 - Euclidean topological, 466
 - geometric realization, 466
 - smooth, 484
- geometric Postnikov tower, 355
- geometric prequantization
 - of 3-forms, 545
 - ordinary, 540
 - smooth, 536
- geometric prequantum theory, 393
- geometric Whitehead tower, 356
 - Euclidean-topological, 475
- groupoids
 - group of bisections, 294
- Heisenberg ∞ -Lie algebra, 404
- holonomy, 385
 - smooth, 524, 531
- homotopy, 287
- infinitesimal path ∞ -groupoid, 427
 - synthetic differential, 566
- jet ∞ -bundles, 429
- local system, 357
- manifolds, 366
 - separated, 435
 - smooth manifolds, 493
 - topological manifolds, 469
- Maurer-Cartan forms, 372
 - smooth, 506
- paths, 355
 - Euclidean topological, 470
 - smooth, 487
- petit ∞ -topos of an object, 437
- phase space, 438
 - in introduction, 196
- Poisson ∞ -Lie algebra, 404
- Postnikov towers, 274
- prequantum geometry
 - contactomorphisms, 399
 - Heisenberg group, 399
 - prequantization, 398
 - quantomorphism group, 399
- prequantum operator, 405
- prequantum states, 404
- principal ∞ -bundles, 309
 - discrete, 452
 - Euclidean-topological, 472
 - smooth, 489
 - synthetic differential, 561
- relative cohomology, 349
- structure sheaf, 437
- transgression, 386
- truncated objects, 274
- twisted cohomology, 334
 - discrete, 454
 - smooth, 491
 - stable (Eilenberg-Steenrod-type), 444
- twisted differential structures, 384
- universal coverings, 356
- WZW functional, 387
- structures in a cohesive ∞ -toposymplectomorphisms, 398
- supergravity, 651
 - C -field, 655, 656
 - dual C -field, 655

- M5-brane Lie 6-algebra, 654
- supergravity Lie 3-algebra, 653
- symplectic L_∞ -algebroid, 674
 - definition, 674
- symplectic higher geometry, 670
 - geometric prequantization, 393
 - in introduction, 27
 - Hamiltonian vector fields, 404
 - 2-plectic, 545
 - ordinary, 540
 - Heisenberg ∞ -group, 404
 - Heisenberg ∞ -Lie algebra, 404
 - Poisson ∞ -Lie algebra, 404
 - prequantum circle n -bundles, 536
 - prequantum circle bundle, 540
 - prequantum operator
 - ordinary, 544
 - symplectic L_∞ -algebroids, 674
 - symplectic smooth ∞ -groupoid, 676
- T-duality, 669
- topos
 - ∞ -connected, 246
 - cohesive, 250
 - descent, 228
 - Giraud-Lurie axioms, 293
 - locally ∞ -connected, 246
 - overview, 61, 63
 - petit, 304
 - presentation by simplicial C -manifolds, 227
 - presentation by simplicial presheaves, 226
- topos theory, 221
 - ∞ -topos, 221
 - base change, 272
 - constant ∞ -stacks, 223
 - global sections, 223
 - presentation by simplicial C -manifolds, 227
 - presentation by simplicial presheaves, 226
 - presentations, 224
 - syntax, 223
 - terminal geometric morphism, 223
- twisted cohomology
 - differential cohomology, 376
 - differential integral Wu structures, 658
 - exceptional generalized geometry, 622
 - group cohomology
 - with coefficients, 454
 - orientifold, 623
 - membrane-, 668
 - string-, 624
 - orthogonal structure, 619
 - reduction of structure group, 616
 - Riemannian structure, 619
 - sections of vector bundles, 610
 - T-duality, 669
 - twisted \mathfrak{c} -structures, 384
 - twisted spin^c -structure, 636
 - smooth, 638
 - twisted spin^c -structures, 636
 - twisted 2-bundle, 89
 - abelian example, 87
 - twisted string-2-bundle, 89
 - twisted bundle, 84, 612
 - by twisted spin^c -structure, 638
 - on D-brane, 639
 - twisted differential \mathfrak{c} -structures, 385, 602
 - twisted differential \mathfrak{c}_1 -structures, 634
 - twisted differential fivebrane structure, 641
 - twisted differential string structure, 640
 - twisted differential structures in quantum anomaly
 - cancellation, 634
 - twisted fields
 - overview, 602
 - twisted fivebrane structure, 640
 - twisted K-theory, 612
 - twisted string structure, 640
 - twisted topological structures
 - examples, 626
 - type II generalized geometry, 621
 - U-duality geometry, 622
- U-duality, 622
- universal principal ∞ -bundle, 317
 - for topological simplicial groups, 464
 - in introduction, 90
- Wess-Zumino-Witten functionals
 - as boundaries of Chern-Simons field theories, 392
 - brane intersection laws, 733
 - examples, 729
 - general abstract, 387
 - Lie n -algebraic formulation, 730
 - parameterized, 682
 - super p -branes, 736
 - bouquet, 745
 - D-brane type IIA, 740
 - D-brane type IIB, 742
 - M2-brane, 653
 - M5-brane, 743
 - traditional, 729