

 esa

  
**bulletin**

number 89 - february 1997





## europaan ruimtevaartorganisatie

The European Space Agency was formed out of, and took over the rights and obligations of, the two earlier European Space Organisations: the European Space Research Organisation (ESRO) and the European Organisation for the Development and Construction of Space Vehicle Launchers (ELDO). The Member States are Austria, Belgium, Denmark, Finland, France, Germany, Ireland, Italy, Netherlands, Norway, Spain, Sweden, Switzerland and the United Kingdom. Canada is a Cooperating State.

In the words of the Convention: The purpose of the Agency shall be to provide for and to promote, for exclusively peaceful purposes, co-operation among European States in space research and technology and their space applications, with a view to their being used for scientific purposes and for operational space applications systems.

- (a) by elaborating and implementing a long-term European space policy, by recommending space objectives to the Member States, and by concerting the policies of the Member States with respect to other national and international organisations and institutions;
- (b) by elaborating and implementing activities and programmes in the space field;
- (c) by co-ordinating the European space programme and national programmes, and by integrating the latter progressively and as completely as possible into the European space programme, in particular as regards the development of applications satellites;
- (d) by elaborating and implementing the industrial policy appropriate to its programme and by recommending a coherent industrial policy to the Member States.

The Agency is directed by a Council composed of representatives of Member States. The Director General is the chief executive of the Agency and its legal representative.

The ESA HEADQUARTERS are in Paris.

The major establishments of ESA are:

THE EUROPEAN SPACE RESEARCH AND TECHNOLOGY CENTRE (ESTEC), Noordwijk, Netherlands.

THE EUROPEAN SPACE OPERATIONS CENTRE (ESOC), Darmstadt, Germany

ESRIN, Frascati, Italy.

Chairman of the Council: H. Parr

Director General: J.-M. Luton.

## agencia espacial europea

L'Agence Spatiale Européenne est issue des deux Organisations spatiales européennes qui l'ont précédée — l'Organisation européenne de recherches spatiales (CERS) et l'Organisation européenne pour la mise au point et la construction de lanceurs d'engins spatiaux (CECLES) — dont elle a repris les droits et obligations. Les Etats membres en sont: l'Allemagne, l'Autriche, la Belgique, le Danemark, l'Espagne, la Finlande, la France, l'Irlande, l'Italie, la Norvège, les Pays-Bas, le Royaume-Uni, la Suède et la Suisse. Le Canada bénéficie d'un statut d'Etat coopérant.

Selon les termes de la Convention: l'Agence a pour mission d'assurer et de développer, à des fins exclusivement pacifiques, la coopération entre Etats européens dans les domaines de la recherche et de la technologie spatiales et de leurs applications spatiales, en vue de leur utilisation à des fins scientifiques et pour des systèmes spatiaux opérationnels d'applications.

- (a) en élaborant et en mettant en oeuvre une politique spatiale européenne à long terme, en recommandant aux Etats membres des objectifs en matière spatiale et en concertant les politiques des Etats membres à l'égard d'autres organisations et institutions nationales et internationales;
- (b) en élaborant et en mettant en oeuvre des activités et des programmes dans le domaine spatial;
- (c) en coordonnant le programme spatial européen et les programmes nationaux, et en intégrant ces derniers progressivement et aussi complètement que possible dans le programme spatial européen, notamment en ce qui concerne le développement de satellites d'applications;
- (d) en élaborant et en mettant en oeuvre la politique industrielle appropriée à son programme et en recommandant aux Etats membres une politique industrielle cohérente.

L'Agence est dirigée par un Conseil, composé de représentants des Etats membres. Le Directeur général est le fonctionnaire exécutif supérieur de l'Agence et la représente dans tous ses actes.

Le SIÈGE de l'Agence est à Paris.

Les principaux Etablissements de l'Agence sont:

LE CENTRE EUROPEEN DE RECHERCHE ET DE TECHNOLOGIE SPATIALES (ESTEC), Noordwijk, Pays-Bas.

LE CENTRE EUROPEEN D'OPERATIONS SPATIALES (ESOC), Darmstadt, Allemagne.

ESRIN, Frascati, Italie

Président du Conseil: H. Parr

Directeur général: J.-M. Luton.

# bulletin

contents/sommaire

number 89 - february 1997



Cover: Final inspection of a master mandrel used to replicate the XMM satellite's X-ray mirrors. See article on page 68. (Photo courtesy of Carl Zeiss)

## Editorial/Circulation Office

ESA Publications Division  
ESTEC, PO Box 299, Noordwijk  
2200 AG The Netherlands  
Tel.: (31) 71 5653400

## Editors

Bruce Battrick  
Duc Guyenne  
Dorothea Danesy

## Layout

Carel Haakman

## Graphics

Willem Versteeg

## Montage

Keith Briddon  
Isabel Kenny

## Advertising

Brigitte Kaldeich

The ESA Bulletin is published by the European Space Agency. Individual articles may be reprinted provided the credit line reads 'Reprinted from ESA Bulletin', plus date of issue. Signed articles reprinted must bear the author's name. Advertisements are accepted in good faith; the Agency accepts no responsibility for their content or claims.

Copyright © 1997 European Space Agency  
Printed in The Netherlands ISSN 0376-4265

**European Space Agency**  
**Agence spatiale européenne**

## THE MINISTERIAL MEETING

### Vers une nouvelle politique industrielle

— Session du Conseil ESA au niveau ministériel du 4 mars 1997

6

### Towards a New Industrial Policy

— The ESA Council Meeting at Ministerial Level on 4 March 1997

7

### Ariane-5: Learning from Flight 501 and Preparing for 502

*J. de Dalmau & J. Gigou*

38

### Capsule ARD — Essai en vol de la phase terminale de la mission

*C. Cazaux & B. Tetry*

48

### The Monitoring of Gaseous Contaminants in Spacecraft Cabin Atmospheres

*G.B.T. Tan, C.J. Savage & H. Bittner*

53

### The ATV Rendezvous Pre-development (ARP) Project

*M. Cislighi, M. Lellouch & J.M. Pairo*

60

### Producing the X-Ray Mirrors for ESA's XMM Spacecraft

*D. de Chambure et al.*

68

### The Evolution of ESA's Spacecraft Control Systems

*A. Baldi et al.*

81

### On-Board Training and Operational Support Tools Applying Web Technologies

*J. Auferil & L. Bessone*

90

### Serving the Earth-Observation Community: The CEOS Dossier

*L. Fusco, S.G. Ansari & B. Bizzarri*

100

### International Cooperation in Space — Developing New Approaches

*G. Gibbs & I. Pryke*

102

### Use of Space Technologies for Major-Risk Management

*G. Naja*

111

### Focus Earth: ERS Watches Mount Pinatubo

*J. Lichtenegger & G. Calabresi*

116

### Programmes under Development and Operations

Programmes en cours de réalisation et d'exploitation

119

### In Brief

125

### Publications

132

# THE FAR INFRARED AND SUBMILLIMETRE UNIVERSE

*A Symposium*

*jointly organised by ESA and IRAM devoted to the  
Far Infrared and Submillimetre  
Telescope (FIRST) mission*

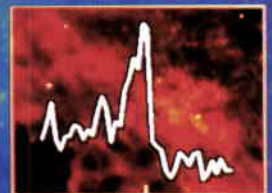
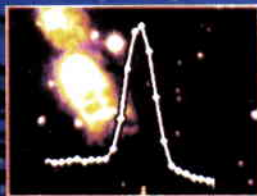
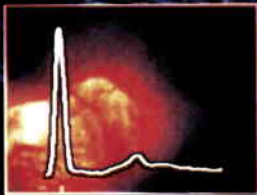

15 – 17 April 1997

Venue: ENSIEG

Domaine Universitaire de Grenoble  
France

**Scientific Programme Committee**

M. Rowan-Robinson, UK, Chairman	T. Phillips, USA
A. Franceschini, I	G. Pilbratt, NL
R. Genzel, D	J.-L. Puget, F
M. Grewing, F	G. Sholomitski, R
R. Hills, UK	P. Solomon, USA
J. Mather, USA	E. van Dishoeck, NL
G. Miley, NL	S. Volonte, F
L. Nordh, S	C. Waelkenis, B
H. Okuda, J	

**For further information, please contact:**

Dr S. Volonte, European Space Agency  
8 – 10, rue Mario Nikis  
F – 75738 Paris Cédex 15  
France  
Tel.: 33 – 1.53.69.71.03  
Fax: 33 – 1.53.69.72.36  
Email: [svolonte@hq.esa.fr](mailto:svolonte@hq.esa.fr)

WWW address: <http://astro.estec.esa.nl/SA-general/Symposia/Grenoble/grenoble.html>



**IRAM**

Institut de  
Radio-Astronomie Millimétrique

# Monkey on your back #17 How to buy the world's fastest 3D workstation when you think you can't afford it.

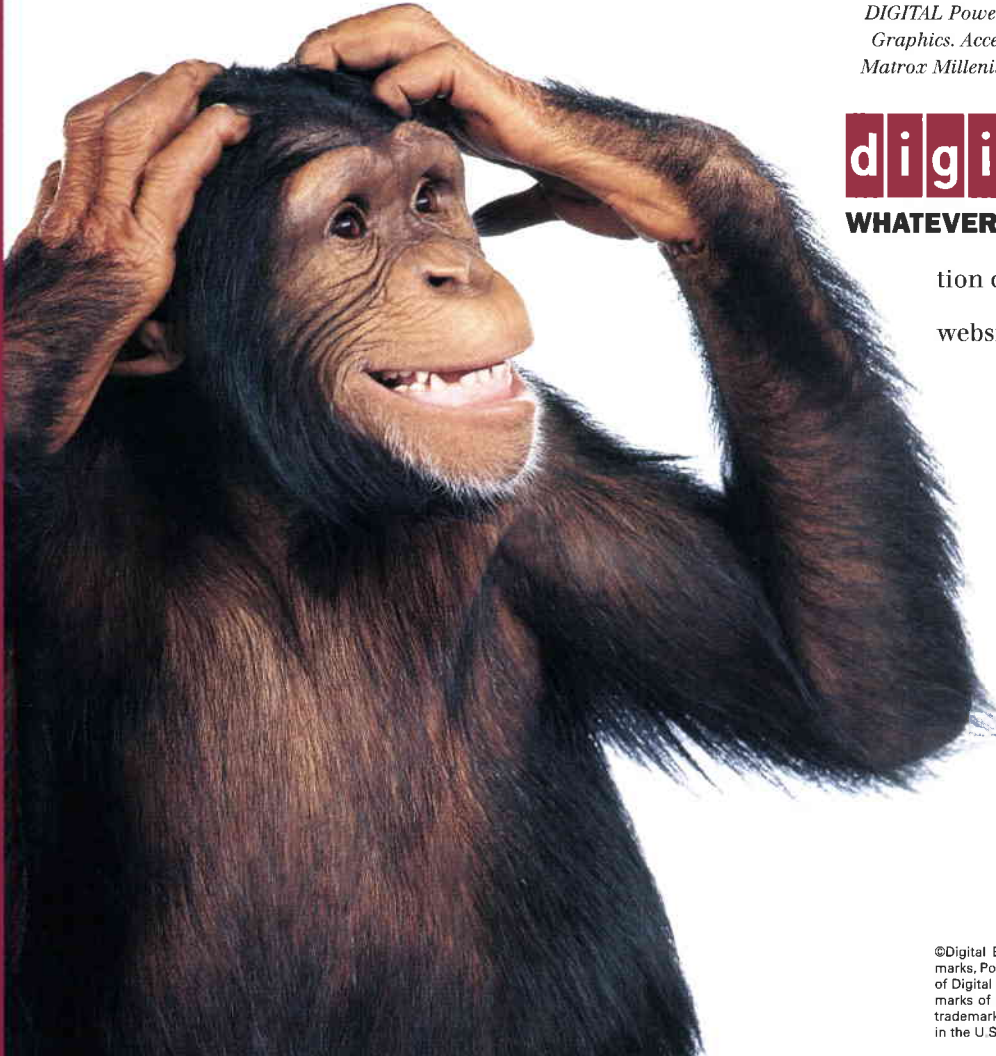

If you think fast graphics automatically means big bucks, you haven't seen the new DIGITAL Personal Workstation a-Series. Not only does this Alpha workstation run Windows NT® 3D graphics faster than any other workstation, but its price is unbeatable. For example, in the Bench95 benchmark running Pro/ENGINEER®, the DIGITAL Personal Workstation Alpha scored a record-



*DIGITAL Personal Workstation  
Intel/Alpha*

*Choice of 433 mHz of 500 mHz  
Intel/Alpha processors*

*ECC SDRAM memory 0-2MB  
L3 cache*

*5 PCI-slots  
(2PCI, 3PCI/ISA)*

*DIGITAL PowerStorm® 3D  
Graphics. AccelPro Series,  
Matrox Millennium Graphics*

setting low 56 minutes, 59% faster than the next fastest competitor for less than half the price. Our family of Intel® and Alpha platforms give you support for thousands of Win32 applications. Add to this DIGITAL's wealth of service and support which provides seamless interoperability between your UNIX® and Windows NT

**digital**™

**WHATEVER IT TAKES**™

operating systems, and you can't ask for more. For less. For more information call DIGITAL (06 - 022 75 95) or visit our website (<http://www.workstation.digital.com>).

©Digital Equipment Corporation, 1997. DIGITAL and the DIGITAL logo are trademarks, PowerStorm is a registered trademark and Whatever It Takes is a service mark of Digital Equipment Corporation. Microsoft and Windows NT are registered trademarks of Microsoft in the U.S. and other countries. PRO/ENGINEER is a registered trademark of Parametric Technology Corporation. UNIX is a registered trademark in the U.S. and other countries, licensed exclusively through X/Open Company, Ltd.

**C**ables from GORE are the life line of state-of-the-art space technology; individually designed and tested for optimal signal transmission – especially for long-term missions:

- low-loss microwave assemblies to 60 GHz
- flexible dielectric waveguides to 110 GHz
- a comprehensive selection of round, ribbon and high-voltage cables
- power and signal lines qualified to ESA/SCC 3901 / 009, 017, 018, 019 and 021

**Pit stops not included!**

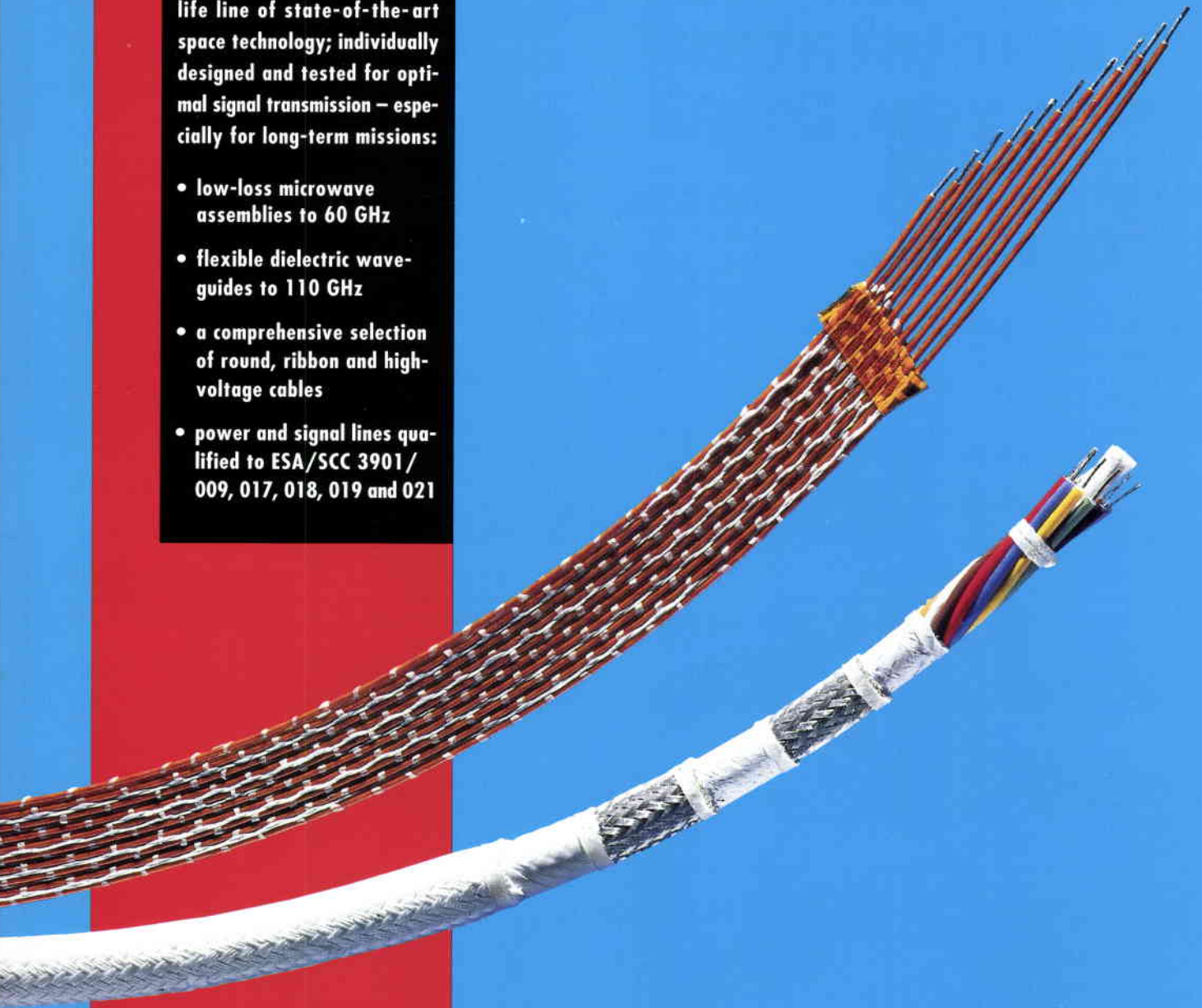

**GORE**

W.L. GORE & ASSOCIATES GmbH  
Nordring 1  
D-91785 Pleinfeld  
Tel.: (00 49 91 44) 6 01-0  
Fax: (00 49 91 44) 6 01-4 53

*The German research satellite ROSAT is equipped with Gore cables. Delicate measurements of astrophysical phenomena are performed and transmitted without compromising precision.*

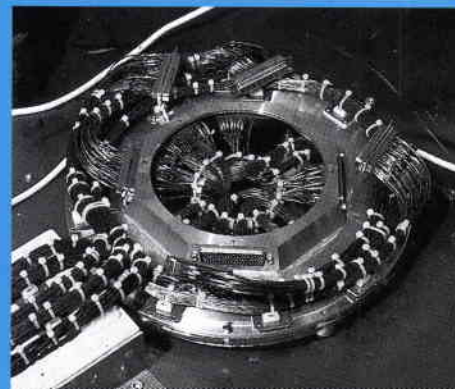



TTC TRANSPONDER

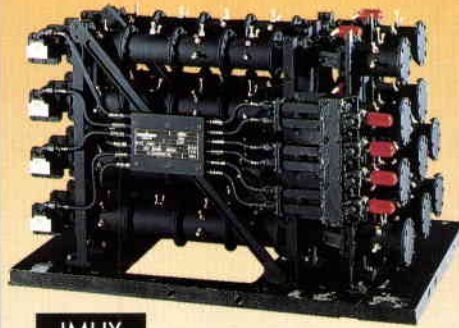

IMUX

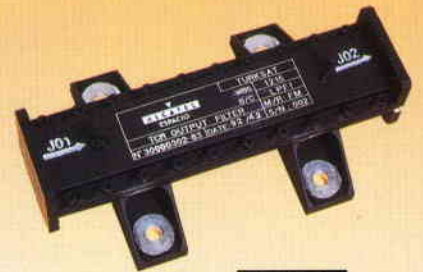

FILTERS



BPSK MODULATOR

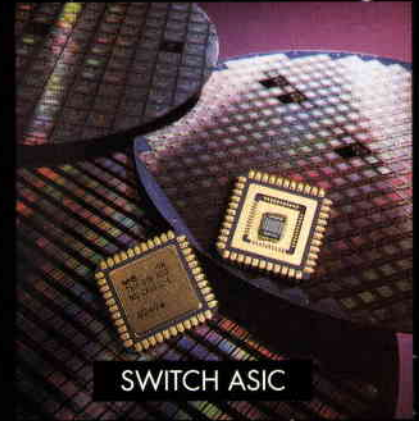

SWITCH ASIC



RTU



APMD



CDPU

# ALCATEL ESPACIO: Quality in Time.

Alcatel Espacio designs and manufactures equipment and satellite subsystems including:

- On-board Digital Equipment (Processors, Data Handling, Antenna Pointing Mechanism, etc).
- On-board Radiofrequency Equipment

(TTC transponders, Filters, Diplexers, Multiplexers, etc.)

The organization of Alcatel Espacio is focused to meet the requirements of the customer, guaranteeing in any case, Quality in Time.

ALCATEL  
ESPACIO

Alcatel Espacio, S.A. Einstein nº 7. Tres Cantos 28760 Madrid. Spain.  
Tel. (34) 1 807 79 00. Fax. (34) 1 807 79 99.

## Vers une nouvelle politique industrielle

– Session du Conseil ESA au niveau ministériel du 4 mars 1997

La dernière session du Conseil de l'ESA au niveau ministériel s'est tenue à Toulouse en octobre 1995. Il y a été demandé à l'Exécutif de revoir la politique industrielle de l'Agence et le système de calcul du barème de contributions à ses programmes obligatoires. Une résolution adoptée lors de cette session a porté sur des questions de politique industrielle dans un chapitre traitant spécifiquement des trois points suivants:

- correction des déséquilibres passés du retour industriel; dans ce point, les ministres ont apprécié les efforts déjà accomplis pour améliorer la situation et invité le Directeur général de l'ESA à prendre des mesures de nature à réduire les déséquilibres résiduels;
- amélioration des procédures d'approvisionnement; les ministres ont souligné ici l'importance de telles procédures pour améliorer le rapport coût/efficacité et la compétitivité de l'industrie européenne, et ont invité le Directeur général à avoir davantage recours dans ses relations avec les contractants aux appels d'offres concurrentiels et aux systèmes d'encouragement ou de pénalité financiers;
- revue de la politique industrielle de l'Agence; sur ce point, les ministres ont souligné l'importance de la politique industrielle pour l'avenir de l'Agence et décidé de constituer un Groupe de travail chargé d'analyser et d'évaluer la politique industrielle actuellement menée par l'Agence, de proposer des adaptations, et ont invité le Directeur général à soumettre une proposition au Conseil réuni au niveau ministériel.

A l'issue d'une année de travaux conduits par les représentants des Etats membres de l'Agence et le Directeur général afin de faire droit à ces différentes demandes, les ministres et hauts fonctionnaires représentant les quatorze Etats membres de l'Agence, ainsi que le Canada en tant qu'Etat coopérant et la

Commission de l'Union européenne en qualité d'observateur, se sont à nouveau réunis le 4 mars pour examiner les propositions soumises par le Directeur général afin d'adapter la politique industrielle de l'Agence, de liquider les déséquilibres passés du retour géographique et de réformer le système de calcul du barème des contributions aux activités obligatoires. La session était placée sous la présidence de M. Yvan Ylieff, ministre belge de la politique scientifique, qui avait déjà présidé celle de Toulouse.

M. Hugo Parr, Président du Conseil au niveau des délégués ayant tout d'abord rappelé aux





## Towards a New Industrial Policy

– The ESA Council Meeting at Ministerial Level on 4 March 1997

At the last ESA Council Meeting at Ministerial level, in Toulouse in October 1995, the Agency was asked to review its industrial policy and the system for calculating the scale of contributions to its Mandatory Programme. A Resolution adopted at that meeting addressed industrial-policy matters in a specific chapter focusing on three topics:

- correction of overall industrial-return imbalances; here the Ministers appreciated the efforts already made to take measures to reduce residual imbalances
- improvement of procurement procedures; here the Ministers stressed the impor-

tance of these procedures to the cost-effectiveness and the competitiveness of European industry, and invited the Director General to make increased use of competitive tendering and financial incentives or penalties for contractors

- review of the Agency's industrial policy; here the Ministers, underlining the importance of industrial policy to the future of ESA, decided to set up a Council Working Group to analyse and evaluate the Agency's current industrial policy and to propose adaptations, and invited the Director General to submit a proposal to Council at Ministerial Level.



*Les ministres et hauts fonctionnaires réunis du siège de l'ESA*

**The assembled Ministers and Senior Officials at ESA Head Office**



**Mr Jean-Marie Luton (left)  
and Mr Yvan Ylieff**

**M. Jean-Marie Luton et  
M. Yvan Ylieff (à droite)**

participants l'origine et le cadre des débats, M. Jean-Marie Luton, Directeur général après avoir rappelé les succès de l'ESA à ce jour, a souligné l'importance de la réforme de la politique industrielle dans le contexte général de l'évolution de l'Agence.

Ensuite, en reprenant pour l'essentiel les objectifs assignés lors de sa dernière session tenue à Toulouse:

- rentabilité accrue des ressources de l'ESA
- croissance des parts de marchés mondiaux conquises par l'industrie européenne
- mobilisation des compétences techniques et stimulation des capacités d'innovation de l'industrie européenne, en particulier dans les Petites et Moyennes Entreprises
- recherche d'un équilibre entre les intérêts des contractants principaux et ceux des sous-contractants,

le Conseil au niveau ministériel a décidé:

- de rationaliser les procédures de décision en assurant la continuité des programmes préparatoires et des programmes de développement

- de mettre en oeuvre des accords de partenariat avec l'industrie européenne pour tout ce qui a trait à sa compétitivité mondiale
- de mettre en oeuvre des mesures permettant de tirer le meilleur bénéfice du tissu industriel existant
- d'introduire la flexibilité nécessaire dans les contributions financières des compétitions entre industriels tout en respectant l'équité des retours.

Cette nouvelle politique sera progressivement mise en place pendant la période 1997 à 1999 et des mesures spéciales seront prises afin de compenser les déficits du passé enregistrés par certains Etats-membres.

Enfin, le Conseil au niveau ministériel a décidé de se réunir de nouveau en 1998 pour prendre les décisions sur les programmes futurs de l'ESA avec une vision stratégique d'ensemble incluant le rôle d'autres entités européennes s'occupant de questions spatiales.

A l'issue de cette réunion, M. Yvan Ylieff a déclaré:

*'Je suis particulièrement satisfait que nous ayons adopté une résolution qui constitue une étape importante vers une utilisation encore meilleure des investissements publics dans l'espace ainsi que du tissu industriel et du potentiel d'innovations en Europe tout en renforçant notre compétitivité sur les marchés mondiaux.'*



After a year of work by representatives of ESA's Member States and the Director General to comply with these various requests, the Ministers and senior officials representing the Agency's fourteen Member States, plus Canada as a Cooperating State and the European Commission with Observer status, met again on 4 March to discuss the Director General's proposals for the adaptation of the Agency's industrial policy, the clearance of past return imbalances, and the reform of the system for calculating the scale of contributions to the Agency's mandatory activities. The meeting was chaired by Mr Yvan Ylieff, the Belgian Minister for Science Policy, who had chaired the Toulouse meeting.

Mr Hugo Parr, Chairman of the ESA Council at Delegate Level, opened the discussion by recapitulating the background and context. Mr Jean-Marie Luton, ESA's Director General, having emphasised the Agency's successes to date, stressed the importance of industrial-policy reform in the general context of the Agency's evolution.

Endorsing the main objectives assigned at the Toulouse meeting, namely:

- to make more cost-effective use of ESA's resources
- to increase European industry's share of World markets
- to mobilise the technical skills and stimulate the innovative capacity of European industry, paying special attention to small- and medium-sized businesses
- to achieve a balance between the interests of the main contractors and those of the sub-contractors,

the Council at Ministerial Level decided to:

- streamline the Agency's decision-making procedures by maintaining continuity between its preparatory and its development programmes
- implement partnership agreements with European industry in all areas affecting its competitiveness in World markets
- apply measures designed to derive maximum benefit from the existing industrial fabric
- introduce the necessary flexibility into Member States' financial contributions to

ESA programmes, thus benefiting from competition between industrial suppliers whilst at the same time maintaining a fair distribution of returns.

The new policy will be introduced gradually over the period 1997 to 1999, and special measures will be taken to compensate for the past deficits accumulated by certain Member States.

Finally, the Council at Ministerial Level decided to meet again in 1998 to take decisions on the Agency's future programmes from the perspective of an overall strategy encompassing the roles of other European bodies involved in the space sector.

At the end of the meeting, Mr Ylieff said:

*'I am especially pleased that we have adopted a resolution making a major step towards even better use of public investment in the space sector of Europe's industrial fabric and capacity for innovation, while strengthening our competitiveness on World markets.'* ©

ESA/C-M/CXXIX/Rés.1 (Final)

## **RÉSOLUTION SUR LA POLITIQUE INDUSTRIELLE DE L'AGENCE**

(adoptée le 4 mars 1997)

Le Conseil, siégeant au niveau ministériel,

**RECONNAISSANT** que l'Agence est l'acteur qui permet à l'Europe de rester à l'avant-garde des activités spatiales par sa réputation exceptionnelle dans le domaine des missions scientifiques, des lanceurs, des vols spatiaux habités et de la microgravité, ainsi que des satellites de navigation, de télécommunications et d'observation de la Terre, et **RECONNAISSANT** en même temps que l'Agence a joué un rôle de premier plan dans le développement de l'industrie spatiale européenne,

**CONSIDÉRANT** comme capital que l'Agence continue de jouer ce rôle de premier plan dans la promotion des activités spatiales en Europe,

**RECONNAISSANT** qu'il est d'une importance extrême pour l'Agence d'aller résolument de l'avant, de façonner son avenir et par conséquent de prendre des mesures destinées à adapter sa politique industrielle afin de réagir plus efficacement aux profonds changements que connaît actuellement le contexte économique et industriel et **CONVAINCU** que non seulement ces mesures donneront à l'Agence des bases solides pour décider de ses futurs programmes et activités et les mener à bien mais qu'elles renforceront également la compétitivité de l'industrie européenne sur les marchés internationaux,

**RECONNAISSANT** que les décisions relatives à l'adaptation de la politique industrielle de l'Agence contribueront de façon significative à faire progresser l'Agence vers le vingt-et-unième siècle,

**PROJETANT** de s'orienter pour l'avenir vers un système d'approvisionnement des projets plus ouvert à la concurrence dans lequel les attentes fermes en matière de retour joueront un rôle moins prépondérant que par le passé,

ESA/C-M/CXXIX/Res. 1(Final)

**Resolution on the European Space Agency's industrial policy**

(adopted on 4 March 1997)

Council, meeting at ministerial level,

RECOGNISING that the Agency is the means of keeping Europe at the forefront of space activities with an outstanding reputation in scientific missions, launchers, manned spaceflight and microgravity, navigation, communication and Earth observation satellites and, at the same time, RECOGNISING that the Agency has played a leading part in the development of the European space industry,

CONSIDERING it essential that the Agency maintain its leading role in promoting space activities in Europe,

RECOGNISING that it is of utmost importance for the Agency to move resolutely forward in shaping its future and accordingly take steps to adapt its industrial policy for the purpose of responding more effectively to the current profound changes in the economic and industrial environment and CONVINCED that this will serve not only to provide the Agency with a firm basis on which to decide and execute its future programmes and activities but also to reinforce the competitiveness of Europe's industry on international markets,

RECOGNISING that decisions on the adaptation of the Agency's industrial policy will contribute significantly to the Agency's evolution towards the twenty-first century,

INTENDING to move for the future towards a more competitive and open system of project procurement in which fixed expectations will play a less dominant role than they have in the past,

ESA/C-M/CXXIX/Rés. 1 (Final)  
page 2

RAPPELANT l'Article VII de la Convention qui fixe les objectifs de la politique industrielle de l'Agence, ainsi que ses Annexes III et V,

VU l'intérêt qu'il a porté sans discontinuer à tous les aspects de la politique industrielle de l'Agence, et qui s'est exprimé dans les dispositions énoncées à ce sujet dans la Résolution n°1 adoptée à Rome le 31 janvier 1985, puis dans les Résolutions adoptées lors de chacune de ses sessions au niveau ministériel,

VU la Résolution relative aux décisions sur les programmes et les finances de l'Agence (ESA/C-M/CXXII/Rés. 1 (Final)) adoptée à Toulouse le 20 octobre 1995, et en particulier son chapitre III.C qui prévoit un réexamen de la politique industrielle de l'Agence,

VU la Résolution relative au mandat du Groupe de travail du Conseil sur la politique industrielle (ESA/C/CXXIII/Rés. 5 (Final)), adoptée le 14 décembre 1995, et NOTANT le résultat des délibérations de ce groupe de travail ainsi que la proposition du Directeur général relative à la politique industrielle de l'Agence exposée dans le document ESA/C-M(97)4,

SE FÉLICITANT des résultats qu'ont donnés les mesures appliquées depuis la session du Conseil de Toulouse, en octobre 1995, afin de corriger les déséquilibres du retour géographique résultant de la répartition des contrats et d'améliorer les procédures d'approvisionnement de l'Agence, et NOTANT les déséquilibres du retour persistant au 31 décembre 1996,

NOTANT la communication intitulée "L'Union européenne et l'espace : Promouvoir les applications, les marchés et la compétitivité de l'industrie" approuvée le 4 décembre 1996 par la Commission européenne,

**ESA/C-M/CXXIX/Res. 1(Final)**  
**page 2**

**RECALLING** Article VII of the Convention setting out the objectives of the Agency's industrial policy, and Annexes III and V to the Convention,

**HAVING REGARD** to the continuous interest it has taken in all aspects of the industrial policy conducted by the Agency, as expressed in the relevant provisions of Resolution No. 1 adopted in Rome on 31 January 1985 and subsequently in Resolutions adopted at each meeting at ministerial level,

**HAVING REGARD** to the Resolution concerning decisions on Agency programmes and finances (ESA/C-M/CXXII/Res. 1 (Final)) adopted in Toulouse on 20 October 1995, and in particular Chapter III.C thereof providing for a review of the Agency's industrial policy,

**HAVING REGARD** to the Resolution on the terms of reference for the Council Working Group on Industrial Policy (ESA/C/CXXIII/Res.5 (Final)) adopted on 14 December 1995 and **NOTING** the outcome of the discussions in that Working Group as well as the Director General's proposal for the Agency's industrial policy outlined in ESA/C-M(97)4,

**WELCOMING** the results brought about by measures applied since the Council meeting at Toulouse in October 1995 to correct geographical return imbalances resulting from the distribution of contracts and to improve the Agency's procurement procedures and **NOTING** the return imbalances remaining at 31 December 1996,

**NOTING** the Communication entitled "The European Union and Space: Fostering Applications, Markets and Industrial Competitiveness" approved on 4 December 1996 by the European Commission,

Chapitre I : Décisions générales

1. DÉCIDE d'engager une adaptation de la politique industrielle de l'Agence sur la base des principes définis au chapitre II et CONVIENT de ce que les règles et procédures pertinentes seront modifiées en conséquence par le Conseil lorsque commencera la préparation des décisions à venir en ce qui concerne les nouveaux programmes facultatifs.
  
2. DÉCIDE que la période 1997 à 1999 sera une période de transition durant laquelle :
  - les règles et procédures d'application des principes exposés au chapitre II seront élaborées ;
  - ces règles et procédures seront appliquées et éprouvées dans le cadre des nouvelles activités et programmes facultatifs ;
  - la situation du retour géographique dans son ensemble sera encore améliorée ;

l'objectif étant d'appliquer la politique industrielle résultant de la présente Résolution à tous les programmes et activités à compter du 1er janvier 2000 et de commencer à cette date à constituer un nouvel ensemble de statistiques de retour géographique.
  
3. INVITE le Directeur général à procéder à une revue détaillée des résultats de l'application des principes de politique industrielle pendant la période de transition, en temps voulu pour que des propositions relatives à la politique industrielle de l'Agence, à mettre en oeuvre à compter du 1er janvier 2000, soient soumises au Conseil pour décision en 1999, étant entendu qu'un rapport intérimaire sera présenté au Conseil.
  
4. INVITE le Conseil au niveau des délégués à engager un examen d'ensemble de l'évolution de l'Agence, en étroite concertation avec les entités nationales et les autres entités européennes actives dans le domaine spatial, y compris la Commission européenne, en abordant une série de questions parmi lesquelles :
  - une réactualisation de la mission de l'Agence dans les années à venir ;



ESA/C-M/CXXIX/Rés. 1 (Final)  
page 3

Chapter I: General Decisions

1. **DECIDES** to start an adaptation of the Agency's industrial policy on the basis of the principles outlined in Chapter II and **AGREES** that relevant rules and procedures shall be modified accordingly by Council as preparations begin for future decisions on new optional programmes.
  
2. **DECIDES** to establish a transition period from 1997 to 1999 during which:
  - rules and procedures implementing the principles outlined in Chapter II shall be developed;
  - those rules and procedures shall be applied and tested on new optional programmes and activities;
  - the overall geographical return situation shall be further improved;
  
- with the objectives of applying the industrial policy derived from this Resolution to all programmes and activities as from 1 January 2000 and starting a new set of geographical return statistics on that date.
  
3. **INVITES** the Director General to conduct a comprehensive review of the results of the implementation of the principles of industrial policy during the course of the transition period, in good time to put proposals to Council for decisions in 1999 on the Agency's industrial policy to be implemented from 1 January 2000, it being understood that an interim report will be presented to Council.
  
4. **INVITES** Council at delegate level to start an overall examination of the evolution of the Agency, in close consultation with national bodies and other European bodies engaged in space activities, including the European Commission, addressing a range of aspects including:

ESA/C-M/CXXXIX/Rés. 1 (Final)

page 4

- les activités spatiales futures et le rôle de l'innovation ;
- le rôle spécifique de l'Agence par rapport à celui des autres institutions nationales et européennes travaillant dans le domaine spatial et
- le rôle des instituts techniques et de recherche, des laboratoires et des universités dans le domaine des activités spatiales ;

On procédera à cet examen en s'appuyant notamment sur :

- une politique scientifique et technologique favorisant l'amélioration des connaissances humaines, l'innovation, la qualité de la vie et le développement économique d'une manière économiquement efficiente ;
- une politique industrielle visant à améliorer la compétitivité des entreprises européennes à l'échelle mondiale ;

et on évaluera les moyens nécessaires à l'Agence pour s'acquitter du rôle qui lui incombera en conséquence ;

CHARGE le Directeur général et le Président du Conseil de définir pour cet examen une procédure qui prenne en compte les travaux du Comité sur la politique spatiale dans le long terme et de faire le nécessaire en vue de soumettre des recommandations au Conseil lors de sa prochaine session au niveau ministériel prévue début 1998.

## CHAPITRE II : Principes de la future politique industrielle de l'Agence

DÉCIDE des principes ci-après afin d'adapter la politique industrielle de l'Agence en vue d'optimiser le rapport coût/résultat des programmes de l'Agence, d'améliorer la compétitivité de l'industrie européenne à l'échelle mondiale, d'assurer la participation équitable de tous les Etats membres et de bénéficier des avantages de l'appel à la concurrence :

### A. Amélioration des procédures d'exécution des programmes de développement facultatifs

- (1) Le cadre nécessaire à l'exécution d'un programme préparatoire facultatif dans chacun des secteurs de l'activité spatiale sera mis en place en vue de définir et de préparer de façon appropriée les futurs programmes de développement ; les programmes préparatoires en résultant comporteront des études de faisabilité et des études systèmes et les activités technologiques correspondantes offrant ainsi

ESA/C-M/CXXIX/Res. 1(Final)

page 4

- a renewed mission for the Agency in the future;
- future space activities and the role of innovation;
- the specific role of the Agency in relation to that of other European and national institutions engaged in space activities; and
- the role of research and technical institutes, laboratories and universities in space activities;

This examination shall be conducted, based in particular on:

- a scientific and technological policy fostering the improvement of human knowledge, innovation, quality of life and economic development in a cost-effective manner;
- an industrial policy aimed at improving the worldwide competitiveness of European firms;

and the means needed by the Agency to perform the resulting role should be evaluated;

INSTRUCTS the Director General and the Chairman of Council to define a procedure for that examination, taking into account the deliberations of the Long-Term Space Policy Committee, and to proceed with a view to submitting recommendations to the next Council meeting at ministerial level planned for early 1998.

#### CHAPTER II: Principles for the Agency's future industrial policy

DECIDES the following principles for adapting the Agency's industrial policy with a view to optimising the performance-to-cost ratio of the Agency's programmes, improving the worldwide competitiveness of European industry, ensuring equitable participation by all Member States and exploiting the advantages of free competitive bidding:

##### A. Improvement of implementation procedures applied to optional development programmes:

- (1) The necessary framework for carrying out one optional preparatory programme in each

ESA/C-M/CXXIX/Rés. 1 (Final)  
Page 5

à toutes les catégories d'industriels de nombreuses occasions d'être associées aux premières phases des programmes de l'Agence, et stimulant par là l'innovation ;

(2) On exécutera les futurs programmes de développement facultatifs de l'Agence :

- en établissant une phase de définition du projet au cours de laquelle des offres industrielles complètes et à caractère contraignant seront soumises, la sélection parmi ces offres se faisant avant le démarrage de la phase de développement ;
- en exploitant les avantages de l'appel à la concurrence, en particulier au niveau du maître d'oeuvre, et en renforçant les techniques adéquates d'analyse des coûts et d'étalonnage des performances pour obtenir le meilleur rendement de l'investissement ;
- en prenant simultanément, les décisions relatives à la phase de développement et à la phase d'exploitation, s'il y a lieu ;

B. Mesures visant à améliorer la compétitivité de l'industrie européenne à l'échelle mondiale :

- (1) Une formule de partenariat faisant intervenir l'Agence, l'industrie et d'autres parties intéressées sera définie et établie dans le cadre d'un programme approprié de l'Agence destiné à améliorer la compétitivité de l'industrie spatiale européenne à l'échelle mondiale, compte dûment tenu des formules similaires mises en place au niveau national,
- (2) Des mesures seront définies et instaurées pour faire en sorte que les technologies mises au point dans le cadre des programmes de l'Agence favorisent la compétitivité de l'industrie européenne sur les marchés commerciaux et que le choix des nouvelles technologies à mettre au point prenne en compte cet objectif en vue de faciliter leur application à de nouveaux produits et services ;

ESA/C-M/CXXXIX/Res. 1 (Final)  
page 5

field of space activity in order to properly define and prepare future development programmes shall be put in place; the resulting preparatory programmes shall include feasibility and system studies and related technology activities, thus creating wide opportunities for all types of industry to be involved in early phases of the Agency's programmes, and thus stimulating innovation;

- (2) The Agency's future optional development programmes shall be implemented:
- by setting up a project definition phase during which complete and binding industrial offers shall be made and selected before the development phase is initiated;
  - by exploiting the advantages of open competition, in particular at prime contractor level, and reinforcing appropriate cost analysis and benchmarking techniques to obtain best value for money;
  - by deciding, where applicable, on the exploitation phase simultaneously with the development phase;

**B. Actions to improve European industry's worldwide competitiveness:**

- (1) A partnership scheme involving the Agency, industry and other interested parties shall be defined and established in an appropriate Agency programme dedicated to improving the worldwide competitiveness of Europe's space industry, due account being taken of similar schemes being developed at national level;
- (2) Measures shall be defined and established to ensure that the technologies developed under the Agency's programmes benefit Europe's industrial competitiveness on commercial markets and that the choice of new technologies to be developed takes this objective into account, with a view to facilitating their application to new products and services;

ESA/C-M/CXXIX/Rés. 1 (Final)

page 6

C. Mesures visant à garantir une juste répartition des activités entre toutes les entreprises industrielles :

Conformément aux propositions du Directeur général exposées au Chapitre 3.3 du document ESA/C-M(97)4 :

(1) L'Agence garantira l'équité des procédures de mise en concurrence organisées par les maîtres d'oeuvre et la participation des autres sociétés industrielles dès les premiers stades aux travaux générés par les programmes obligatoires et facultatifs de l'Agence, et ce en instaurant les mesures suivantes :

- inclusion d'activités technologiques dans les programmes préparatoires afin de garantir une participation adéquate des contractants autres que le maître d'oeuvre
- organisation de réunions périodiques d'information technique pour les entreprises qui ne sont pas associées aux activités préparatoires ;
- obligation faite aux maîtres d'oeuvre d'inclure dans l'offre industrielle relative à la phase de développement, au moins en tant qu'option, les technologies, produits et compétences industrielles dont l'Agence a établi la liste ;
- fixation par l'Agence d'un quota d'équipements réservés à des contractants autres que le maître d'oeuvre ;
- contrôle par l'Agence durant la phase B de l'équité des mises en concurrence organisées par les maîtres d'oeuvre dans la préparation de leurs offres pour la phase de développement ;

(2) Les approvisionnements concurrentiels seront organisés de façon à ce que les soumissionnaires puissent faire des offres tirant parti de partenariats industriels pré-existants et d'autres relations de travail lorsque ces liens sont compatibles avec les objectifs déclarés de la politique industrielle de l'Agence.

(3) L'Agence fera une place spéciale aux petites et moyennes entreprises (PME) et leur accordera un accès équilibré aux actions de soutien technologique :

- une place spéciale sera faite aux PME dans le cadre de la définition du plan des actions technologiques de l'Agence ;
- les règles du co-financement des travaux de développement technologique seront adaptées à la taille des entreprises ;

ESA/C-M/CXXIX/Res. 1(Final)

page 6

C. Actions to ensure fair allocation of activities among all industrial firms:

In accordance with the Director General's proposals outlined in Chapter 3.3 of ESA/C-M(97)4:

- (1) The Agency shall guarantee fairness in the competitive bidding process organised by prime contractors and early access for other industrial firms to work generated by the Agency's optional and mandatory programmes, through implementation of the following measures:
  - inclusion of technological activities in preparatory programmes, to ensure proper involvement of non-prime contractors;
  - organisation of periodical technical information meetings for companies not involved in preparatory activities;
  - obligation for prime contractors to include, at least as an option, in the industrial offer for the development phase, the technologies, products, and industrial expertise listed by the Agency;
  - definition by the Agency of a quota of equipments reserved to non-prime contractors;
  - control during phase B by the Agency of the fairness of competitions organised by prime contractors in preparing their offers for the development phase;
- (2) Competitive procurement shall be organised in such a way that industrial bidders will be able to offer the benefit of pre-existing industrial teaming arrangements and other relationships, when consistent with the declared objectives of the Agency's industrial policy;
- (3) Small and medium-size enterprises (SMEs) shall be given within the Agency a special place and balanced access to technological support actions by:
  - granting a special place to SMEs in the definition of the plan of technological actions of the Agency,
  - tailoring the rules of co-funding of technological developments to the size of enterprises;

- le soutien technique des experts et laboratoires de l'Agence sera offert aux PME en vue de compléter les capacités techniques nécessaires au développement de leurs propres compétences.

D. Assouplissement de la mise en oeuvre des règles relatives au retour géographique global et aux contributions :

Il faudrait chercher à améliorer le rapport coût/résultat par des mises en concurrence sur la base de principes devant encore être affinés mais incluant au moins le principe combinant retour minimum garanti et ajustement des contributions pour chaque catégorie de programmes et activités de l'Agence, ce qui fournira par la même occasion la souplesse nécessaire à l'organisation de mises en concurrence et le moyen de tendre vers un coefficient de retour géographique global égal à la valeur idéale de l'unité :

- (1) Pour ce qui est des programmes et activités obligatoires, il sera garanti à chaque Etat membre et au Canada un coefficient de retour minimal de 0,9 à la fin de chaque examen formel se tenant tous les trois ans ; tout déficit enregistré à cette occasion par rapport au coefficient de retour garanti ci-dessus sera compensé au moyen de mesures spéciales au cours de la période triennale suivante. Avec cette procédure, les statistiques du retour industriel se rapportant aux programmes et activités obligatoires seront équilibrées tous les trois ans ;
- (2) Pour ce qui est des programmes préparatoires facultatifs, le retour géographique, qui ne sera pas pris en compte dans le choix des équipes industrielles, sera calculé en deux parties, correspondant aux études système et aux activités technologiques connexes ; à la fin de chaque période triennale, la partie correspondant aux activités technologiques sera rééquilibrée par un ajustement des barèmes de contribution pour la période suivante ;
- (3) Pour ce qui est des programmes de développement facultatifs, les contributions initialement souscrites par les Etats participants serviront de base à l'organisation de la procédure devant déboucher sur des offres industrielles complètes et à caractère contraignant et :



ESA/C-M/CXXIX/Res. 1 (Final)  
page 7

- offering SMEs technical support from the Agency's experts and laboratories in order to complement the technical capacities necessary to the development of their own specialty;

D. Introduction of increased flexibility in the implementation of rules pertaining to overall geographical return and contributions:

Improved performance-to-cost ratios should be sought through competitive bidding, on the basis of principles to be further elaborated but including a combination of guaranteed minimum return and adjustments of contributions for each category of the Agency's programmes and activities, providing at the same time the flexibility required for organising industrial competitions and the means of aiming for the ideal overall geographical return coefficient of 1:

- (1) As for the mandatory programmes and activities, each Member State and Canada shall be guaranteed a minimum return coefficient of 0.9 at the end of each formal review taking place every three years; any deficit registered on that occasion with respect to the above guaranteed return coefficient shall be compensated for over the following three-year period, through special measures. By this procedure, industrial return statistics for mandatory programmes and activities shall be balanced every three years;
- (2) As for optional preparatory programmes, the geographical returns, which shall not be taken into account in the selection of industrial teams, shall be calculated in two parts, corresponding to system studies and related technological activities; at the end of each three-year period, the part corresponding to technological activities shall be restored to balance through adjustment of contribution scales for the next period;
- (3) As for optional development programmes, the initial contributions declared by participating States shall be used as a basis for organising the process leading to complete and binding industrial offers, and:
  - industrial activities allocated to a participating State shall correspond to a

ESA/C-M/CXXIX/Rés. 1 (Final)

page 8

- les activités industrielles attribuées à un Etat participant représenteront au minimum 80 % du retour idéal correspondant à la contribution initialement souscrite par ledit Etat,
- au-delà du minimum de 80 %, la contribution effective dudit Etat sera ajustée en fonction des travaux attribués dans le cadre de l'offre industrielle retenue, jusqu'à 120 % au maximum de la contribution initialement souscrite par ledit Etat, étant entendu qu'aucun Etat participant ne sera tenu de poursuivre sa participation si l'enveloppe financière de la phase de développement correspondant à l'offre industrielle retenue dépasse le montant des contributions initialement souscrites,
- il sera appliqué à l'industrie un système de primes au respect des impératifs de retour géographique à l'achèvement de la phase de développement ; ainsi, l'industrie prendra en charge les conséquences des modifications intervenant dans la répartition des activités industrielles pendant cette phase dans la mesure où ces modifications sont dues à des aléas autres que des changements apportés par l'Agence.

Chapitre III : Mise en oeuvre de ces principes pendant la période 1997-1999

INVITE le Directeur général et le Conseil au niveau des délégués, pendant la période 1997-1999 :

- (a) à définir des procédures appropriées de mise en oeuvre des principes exposés au chapitre II, avec en particulier :
  - la mise en place de programmes préparatoires facultatifs ;
  - la mise en oeuvre, pour les nouveaux programmes de développement facultatifs, du découpage en phases et de procédures d'ajustement des contributions, procédures qui viseront à limiter le plus possible l'incidence de ces ajustements sur la planification budgétaire à moyen terme des Etats participants ;
  - l'élaboration de règles conçues pour assurer une participation équilibrée des PME ;
  - l'élaboration de règles applicables au programme destiné à améliorer la compétitivité de l'industrie à l'échelle mondiale ;

ESA/C-M/CXXIX/Res. 1(Final)

page 8

minimum of 80% of the ideal return corresponding to the initial contribution declared by that State,

- the actual contribution of that State shall be adjusted above that minimum of 80% in line with the work allocated in the industrial offer selected, up to a maximum of 120% of the initial contribution declared by that State, it being understood that no participating State shall be bound to participate if the financial envelope of the development phase corresponding to the industrial offer selected exceeds the sum of the initial contributions declared,
- at completion of the development phase, incentives for industry to meet the geographical return will be applied; consequently industry shall bear the consequences of modifications occurring in the distribution of industrial activities during that phase, due to contingencies other than changes introduced by the Agency.

### Chapter III: Implementation of the principles during the period 1997-1999

INVITES the Director General and Council at delegate level, during the period 1997-1999:

- (a) to define appropriate procedures for implementing the principles outlined in Chapter II, including in particular:
- setting-up of optional preparatory programmes;
  - implementation, for new optional development programmes, of the phased approach and of procedures for contribution adjustments; these procedures shall aim at minimising the impact of these adjustments on the medium-term budgetary planning of participating States;
  - rules to ensure a balanced participation of SME's;
  - rules applicable to the programme dedicated to improving industry's worldwide competitiveness;

- l'adaptation des procédures d'approvisionnement et des instruments juridiques correspondants ;

et à vérifier la faisabilité de ces procédures lors de la mise en place de nouveaux programmes facultatifs au cours de cette période ;

(b) à poursuivre l'examen des aspects ci-dessous de la politique industrielle de l'Agence, et à préparer les décisions correspondantes :

- principes applicables aux activités de l'Agence conduites sur la base d'un co-financement avec des tiers ;
- règles applicables aux apports en nature.
- revue des méthodes d'établissement des statistiques de retour industriel.

#### Chapitre IV : Mesures à prendre pour l'arrêt des statistiques de retour en cours

NOTANT qu'en dépit des mesures prises depuis la session du Conseil au niveau ministériel tenue à Toulouse en octobre 1995, le coefficient de retour global de la Suède et de la Suisse à fin 1996 demeurait en deçà de la limite inférieure de 0,96 établie en application de l'Article IV.6 de l'Annexe V de la Convention, le déficit de retour combiné associé équivalant à 33 millions d'ECU de contrats industriels, et que le coefficient de retour global de la Finlande, bien qu'il s'améliore, est lui aussi inférieur à ladite limite,

1. DÉCIDE, pour corriger les déséquilibres du retour géographique de la Suède et de la Suisse au 31 décembre 1996, afin de porter à 0,96 le coefficient de retour global de chacun de ces pays, de mettre en place des mesures spéciales pour un total de 33 millions d'ECU pris en charge par les Etats membres enregistrant un excédent de retour supérieur à 10 millions d'ECU au 31 décembre 1996, proportionnellement à l'excédent de chacun, et INVITE le Directeur général à soumettre avec diligence, fin 1997 au plus tard, des propositions d'application de ces mesures spéciales de manière à en optimiser les bénéfices pour tous les Etats membres ;

ESA/C-M/CXXIX/Res. 1 (Final)  
page 9

- adaptation of associated procurement procedures and legal instruments;

and to test the feasibility of those procedures when setting up new optional programmes during that period;

(b) to pursue the examination of, and prepare decisions on, the following aspects of the Agency's industrial policy:

- principles applicable to the Agency's activities carried out on the basis of joint financing with third parties;
- rules applicable to in kind deliveries;
- review of methods for calculating industrial return statistics.

#### Chapter IV- Measures to be taken to discontinue the current return statistics

NOTING that, in spite of the measures implemented since the Council meeting at ministerial level held at Toulouse in October 1995, at the end of 1996 the overall return coefficients of Sweden and Switzerland were below the lower limit of 0.96 established pursuant to Article IV.6 of Annex V to the Convention, the corresponding combined return deficit representing 33 million ECU in industrial contracts, and that Finland's overall return coefficient, while improving, was also below that limit,

1. DECIDES, for the purpose of correcting the geographical return imbalances of Sweden and Switzerland at 31 December 1996, in order to bring the overall return of each to 0.96, to set up special measures involving a total of 33 million ECU to be covered by Member States having a return surplus above 10 million ECU at 31 December 1996, each in proportion to its surplus, and INVITES the Director General to submit expeditiously, by the end of 1997 at the latest, proposals for implementing those special measures in a manner that will optimise the benefits for all Member States;

ESA/C-M/CXXIX/Rés. 1 (Final)  
page 10

2. DÉCIDE de clôturer au 31 décembre 1999 les statistiques du retour géographique cumulé enregistrées par l'Agence depuis 1972 et de commencer à constituer un nouvel ensemble de statistiques de retour géographique le 1er janvier 2000 de telle sorte que les principes présidant à l'adaptation de la politique industrielle de l'Agence puissent être appliqués à tous les programmes et activités sans qu'il existe une contrainte due aux déséquilibres du retour passés ;
  
3. DÉCIDE que, si le coefficient de retour géographique cumulé au 31 décembre 1999, à l'exclusion des programmes facultatifs dont les déclarations seront ouvertes à la souscription postérieurement à la présente session du Conseil, ne satisfait pas, pour un quelconque Etat membre, aux dispositions de l'Article IV.3 de l'Annexe V de la Convention, des mesures spéciales seront définies pour porter le coefficient de retour de cet Etat membre au niveau satisfaisant défini ci-dessus ; ces mesures spéciales seront prises en charge par les Etats membres ayant un excédent de retour cumulé supérieur à 10 millions d'ECU au 31 décembre 1999 ;

INVITE le Directeur général, afin de réduire le plus possible le besoin de mesures spéciales telles qu'elles sont évoquées au présent paragraphe, à prendre toutes les dispositions nécessaires au cours de la période 1997-1999 pour faire en sorte que l'attribution des contrats par l'Agence conduise, pour tous les pays, à un coefficient de retour global satisfaisant au titre de l'Article IV.3 de l'Annexe V de la Convention ;

et DECIDE :

- (a) de donner priorité, pour la période 1997-1999, au retour géographique global plutôt qu'au retour de chacun des programmes, et
  
- (b) d'instaurer des mesures spéciales devant être prises en charge par les Etats participants enregistrant un excédent de retour et approuvant ces mesures, étant entendu que ces dernières n'auront aucune incidence sur le retour industriel des autres Etats participants ; elles comprennent :

ESA/C-M/CXXIX/Res. 1(Final)

page 10

2. **DECIDES** to discontinue as of 31 December 1999 the cumulative geographical return statistics maintained by the Agency since 1972 and to start a new set of geographical return statistics on 1 January 2000 so that the principles for adaptation of the Agency's industrial policy can be applied to all programmes and activities without being constrained by past return imbalances.
  
3. **DECIDES** that if the cumulative geographical return coefficient as at 31 December 1999, excluding optional programmes whose Declarations will be opened for subscription after the present Council meeting, is not satisfactory for any Member State with regard to Article IV.3 of Annex V to the Convention, special measures shall be defined to bring the return coefficient of that Member State to such satisfactory level; these special measures shall be covered by Member States having a cumulative return surplus above 10 million ECU at 31 December 1999;

**INVITES** the Director General, in order to minimise the need for special measures as described above in this paragraph, to take all steps necessary during the period 1997-1999 to ensure that the distribution of contracts by the Agency results in all countries having an overall return coefficient satisfactory with regard to Article IV.3 of Annex V to the Convention;

and **DECIDES**:

- (a) to give priority during the period 1997-1999 to the overall geographical return rather than to the return from each programme; and
  
- (b) to set up special measures, to be covered by participating States with surplus returns agreeing to such measures, on the understanding that these measures shall not have an impact on the industrial return of the other participating States:
  - involving, in the METOP-1 development programme, 20 million ECU of industrial activities for the benefit of Italy and 2.5 million ECU of industrial

ESA/C-M/CXXIX/Rés. 1 (Final)

Page 11

- l'attribution, dans le cadre du programme de développement de METOP-1, de 20 millions d'ECU d'activités industrielles au bénéfice de l'Italie et de 2,5 millions d'ECU d'activités industrielles au bénéfice de la Suède ;
- l'attribution, dans le cadre de la participation de l'Europe au programme de Station spatiale internationale, de 40 millions d'ECU d'activités industrielles au bénéfice de l'Italie, s'insérant dans les tâches en cours d'examen avec la NASA telles que la construction de noeuds et de 3 millions d'ECU d'activités industrielles au bénéfice de la Suède.

et INVITE le Directeur général à soumettre avec diligence des propositions visant à ajouter des dispositions relatives à ces mesures dans les instruments juridiques régissant les programmes en cause.

- (c) de procéder à un premier examen de la situation en liaison avec la prochaine session du Conseil au niveau ministériel prévue début 1998 ;
4. INVITE le Directeur général à poursuivre ses efforts pour assurer au Canada un retour industriel équitable, dans la même mesure qu'aux Etats membres, étant entendu que des mesures additionnelles à appliquer au-delà de 1998 seront examinées lors des négociations devant déboucher sur la reconduction de l'Accord de coopération entre le Canada et l'Agence.
  5. CONCLUT que les principes énoncés au chapitre II et les mesures d'apurement des déséquilibres passés évoqués ci-dessus constituent une base sur laquelle de nouveaux programmes facultatifs pourront dorénavant être engagés et mis en oeuvre avec pleine exploitation des avantages de la libre concurrence, ce qui permettra d'obtenir le meilleur rendement de l'investissement tout en améliorant la compétitivité de l'industrie européenne à l'échelle mondiale, et sur laquelle ces avantages pourront être étendus à tous les programmes et activités de l'Agence à partir du 1er janvier 2000.



activities for the benefit of Sweden;

- involving, in the European participation in the International Space Station programme, 40 million ECU of industrial activities for the benefit of Italy through the activities currently under discussion with NASA, such as the construction of nodes, and 3 million ECU of industrial activities for the benefit of Sweden;

and INVITES the Director General to submit expeditiously proposals for adding provisions on these measures in existing legal instruments governing the relevant programmes;

- (c) to carry out a first review of the situation in association with next Council meeting at ministerial level planned for early 1998.

4. INVITES the Director General to pursue his efforts to ensure a fair industrial return to Canada to the same extent as provided to Member States, it being understood that additional efforts after 1998 will be part of the negotiations leading to the renewal of the Cooperation Agreement between Canada and the Agency.

5. CONCLUDES that the principles contained in Chapter II and the above measures for clearing up past imbalances establish a basis on which new optional programmes can from now on be started and implemented by exploiting the advantages of free competitive bidding, thus obtaining best value for money and at the same time improving the worldwide competitiveness of European industry, and on which those advantages can be extended to all programmes and activities of the Agency as from 1 January 2000.

ESA/C-M/CXXIX/Rés. 2 (Final)

**RÉSOLUTION RELATIVE A LA RÉVISION DU SYSTÈME  
DE CALCUL DU BARÈME DES CONTRIBUTIONS UTILISÉ PAR  
L'AGENCE POUR FINANCER LES ACTIVITÉS OBLIGATOIRES  
(adoptée le 4 mars 1997)**

Le Conseil, siégeant au niveau ministériel,

VU la Résolution ESA/C-M/CXXII/Rés. 1 (Final) adoptée à Toulouse le 20 octobre 1995, en particulier son Chapitre II, paragraphe 7, sur l'établissement d'un Groupe de travail du Conseil "chargé de revoir, dans le cadre des dispositions pertinentes de la Convention, le système de calcul du barème des contributions utilisé par l'Agence pour financer les activités obligatoires",

VU la Résolution relative au mandat du Groupe de travail du Conseil chargé de revoir le système de calcul du barème des contributions aux activités obligatoires, adoptée par le Conseil le 14 décembre 1995 (ESA/C/CXXIII/Rés. 4 (Final)), notamment la demande d'étudier les critères de définition et d'application des circonstances spéciales visées à l'Article XIII.1.b de la Convention,

PRENANT NOTE des résultats des débats du Groupe de travail du Conseil ainsi que de la proposition du Directeur général relative au système de calcul du barème des contributions utilisé par l'Agence pour financer les activités obligatoires exposé dans le document ESA/C-M(97)5,

VU l'Article XIII.1 de la Convention,

ESA/C-M/CXXIX/Res.2 (final)

**Resolution on the Review of the Agency's System  
for calculating the  
Scale of Contributions for the Mandatory Activities**  
(adopted on 4th March 1997)

The Council, meeting at ministerial level,

HAVING REGARD to Resolution ESA/C-M/CXXII/Res.1(Final) adopted at Ministerial Level in Toulouse on 20 October 1995, in particular to Chapter II, paragraph 7 thereof setting up a Working Group of Council "with the task of reviewing, within the applicable provisions of the Convention, the Agency's system of calculating the scale of contributions for the funding of mandatory activities",

HAVING REGARD to the terms of reference of the Council Working Group Concerning the Review of the Agency's System for Calculating the Scale of Contributions for Mandatory Activities adopted by Council on 14 December 1995 (ESA/C/CXXIII/Res. 4(Final)), including the request to study the criteria for definition and application of the special circumstances referred to in Article XIII.1.b of the Convention,

NOTING the outcome of the discussions in the Council Working Group as well as the Director General's proposal for the Agency's system for calculating the scale of contributions for the mandatory activities outlined in document ESA/C-M(97)5,

HAVING REGARD to Article XIII.1 of the Convention,

ESA/C-M/CXXIX/Rés.2 (Final)

Page 2

### Chapitre I

1. RECONNAÎT que, bien que des agrégats statistiques autres que “le produit national net au coût des facteurs” puissent être pris en compte, le système et les paramètres utilisés à ce jour par l’Agence conformément aux dispositions de la Convention ont permis jusqu’ici d’atteindre l’équilibre nécessaire entre le besoin de visibilité de la planification budgétaire des Etats membres et la nécessité de baser les calculs sur des données économiques comparables et fiables.
2. DÉCIDE que pour améliorer, à compter de la période triennale 1997-1999, l’actualité et l’équité globale des barèmes de contributions aux activités obligatoires, les calculs seront basés sur les taux de conversion moyens entre l’Unité de compte européenne et les monnaies nationales pour la période de 12 mois allant de janvier à décembre de l’année de référence des agrégats statistiques. Le système des coefficients de pondération décidé par le Conseil en 1987 cessant de s’appliquer à compter du barème de contributions 1997/1999 précité, il en résulte une pondération égale pour chacune des trois années statistiques d’une période triennale donnée.

### Chapitre II

RAPPELLE les dispositions de l’Article XIII.1.b de la Convention selon lequel “le Conseil peut décider à la majorité des deux tiers de tous les Etats membres, de réduire temporairement la contribution d’un Etat membre en raison de circonstances spéciales”, et, à cet égard :

1. SOULIGNE que cette possibilité est ouverte à tout Etat membre et que le Conseil doit décider, au cas par cas, des demandes formulées par les Etats membres,

ESA/C-M/CXXIX/Res.2 (final)

Page 2

### Chapter I

1. RECOGNISES that, although statistical aggregates other than the "Net National Products at Factor Costs" could be taken into account, the system and parameters used to date by the Agency in accordance with the provisions of the Convention have thus far achieved the necessary balance between the need for visibility in budgetary planning of the Member States and the requirement of basing calculations upon reliable, comparable economic data .
  
2. DECIDES that, with regard to the objective of improving as from the three-year period 1997-1999 and later the up-to-date quality and the overall equity of the scales of contributions to the mandatory activities, the calculations shall be based on the average conversion rates between the European Currency Unit and national currencies for the twelve-months period January to December of the year to which the statistical aggregates refer. The system of weighting factors decided by Council in 1987 shall cease to be applied as from the same 1997-1999 scale onwards, thus resulting in an equal weighting of all three statistical years of a given three-year period .

### Chapter II

RECALLS the provisions of Article XIII.1.b of the Convention according to which "Council may, by a two-thirds majority of all Member States, decide in the light of any special circumstances of a Member State to reduce its contribution for a limited period", and in this regard:

2. **CONSIDÈRE** que de telles décisions ne devraient être prises qu'après un examen minutieux de tous les facteurs pertinents sur le plan économique constituant les "circonstances spéciales" et ayant une incidence sur la capacité de l'Etat membre à remplir ses obligations financières en ce qui concerne les activités obligatoires,
3. **RAPPELLE** notamment que le revenu annuel par habitant d'un Etat membre, chaque fois qu'il est inférieur à une certaine somme fixée par le Conseil, comme il est dit à l'Article XIII.1.b de la Convention, est un indicateur particulièrement pertinent lorsque l'on statue sur une demande de réduction de contributions ; en outre, son évolution sera également prise en compte,
4. **DEMANDE** au Directeur général de publier chaque année, à partir de 1997, et pour tous les Etats membres, les revenus annuels par habitant et leur évolution au cours des années, ces données devant être prises en compte afin d'assurer un traitement équitable lors de l'examen des demandes de réduction de contributions.

1. **STRESSES** that this possibility is open to any Member State, and that Council should decide, on a case-by-case basis, on applications by Member States ;
2. **CONSIDERS** that such decisions should be taken after careful examination of all economically relevant factors substantiating “Special Circumstances” and having a bearing on the Member State's capacity to meet its financial obligations with regard to the mandatory activities ;
3. **RECALLS** that, amongst others, a Member State's annual per capita income, whenever it is less than an amount to be decided by Council, as provided under Article XIII.1.b. of the Convention, is a particularly relevant indicator when deciding on a request for a reduction in contributions; in addition its evolution will also be taken into account ;
4. **REQUESTS** the Director General to publish on an annual basis starting in 1997 the figures of annual per capita income, and their evolution over the years, of all Member States, so that such data can be taken into account as a means to ensure fair treatment and equity in the examination of applications for a reduction in contributions.

# Ariane-5: Learning from Flight 501 and Preparing for 502

J. de Dalmau & J. Gigou

Ariane Department, Directorate of Launchers, ESA, Paris

**Figure 1. The Ariane-501 launcher on the new pad at the Guiana Space Centre (CSG), Europe's spaceport in Kourou, French Guiana**  
(Photo. CSG for ESA/CNES)

## Introduction

In the early morning of 4 June 1996, at the Guiana Space Centre, Europe's spaceport, the countdown for the maiden flight of Ariane-5 proceeded smoothly until 7 minutes before main engine start ( $H_0 - 7$  min; Fig. 1). At this point the launch was put on hold because the strict visibility criteria for a launch were not met at the opening of the launch window (08 h 35 min local time).

As had been forecast by the local meteorological station, visibility conditions quickly improved and the ignition sequence was initiated at  $H_0 = 09$ h 33min 59s local time (= 12 h 33 min 59s UT). Ignition of the Vulcain engine and the two solid boosters was nominal, as was the ensuing lift-off (Fig. 2). The vehicle performed a nominal flight trajectory until approximately  $H_0 + 37$  s, but shortly thereafter suddenly veered off course, broke up, and exploded.

Preliminary investigation of the flight data showed:

- nominal behaviour of the launcher up to  $H_0 + 36$  s
- failure of the back-up Inertial Reference System, followed immediately by failure of the active Inertial Reference System
- swivelling to the extreme position of the nozzles of the two solid boosters and, slightly later, of the Vulcain engine, causing the launcher to veer abruptly
- self-destruction of the launcher, correctly triggered by rupture of the links between the solid boosters and the Core Stage.

The origin of the failure was rapidly narrowed down to the Flight Control System, and more particularly, to the Inertial Reference Systems, which obviously ceased to function almost simultaneously at around  $H_0 + 36.7$  s.

The self-destruction of the launcher occurred near the launch pad, at an altitude of approximately 4000 m. All of the launcher and satellite debris therefore fell back to ground east of the launch pad, scattering over an area of approximately 12 km<sup>2</sup>.

Recovery of material proved difficult, since this area is nearly all mangrove swamp or savannah. Nevertheless, it was possible to retrieve the two Inertial Reference Systems. Of particular interest was the one which had worked in active mode and stopped





functioning last, and for which, therefore, certain information was not available in the telemetry data (provision for transmission to ground of this information was confined to whichever of the two units might fail first). The results of the examination of this unit were very helpful in the analysis of the failure sequence.

An independent Inquiry Board was set up in the days following the incident, and in its conclusions one can read:

*The failure of Ariane-501 was caused by the complete loss of guidance and attitude information 37 s after start of the main engine ignition sequence (30 s after lift-off). This loss of information was due to specification and design errors in the software of the Inertial Reference System.*

The fourteen Recommendations of the Inquiry Board are listed in the accompanying panel. (see next page).

#### Technical evaluation of flight 501

A comprehensive, so-called 'level-1' assessment of the detailed telemetry data acquired during the forty seconds of flight has been carried out. Few anomalies other than that which proved fatal have been observed and they do not call for important changes to the launcher's design. Two main points are being studied – aerodynamic coupling and the blow-back of jet streams on ignition – and both are discussed in detail in the following survey of each system.

#### Booster stage

The two booster stages operated normally for 37 s. The observed pressure laws in the two boosters were, in particular, highly symmetrical. The following anomalies could, however, be noted:

- lower than predicted values in the first part of the pressure curve, but still within specification
- a greater than expected load on one of the servo-actuators of the solid-booster stage on the opening of its cut-off valve during the countdown. Suitable procedures have now been defined to eliminate this phenomenon and no hardware changes are envisaged in the short term.

#### Main cryogenic stage

The main stage and Vulcain engine functioned satisfactorily until 38 s into the flight. The ignition sequence was nominal and pressurisation of the liquid-oxygen (LOX) and liquid-hydrogen (LH<sub>2</sub>) tanks was in line with predictions. The only significant anomaly was increasing pressure fluctuations inside the

servo-actuators from H0 + 20 s onwards. The likely cause is 'buffeting', a coupling between the aerodynamic forces and the aft structure of the launcher, which affected the Vulcain engine's servo-actuators. With the explosion of the launcher, it did not, however, prove possible to obtain a complete picture of this coupling, which is by nature transient. Subsequent tests have confirmed this physical phenomenon and show that there would be no divergence even in extreme cases.

#### Vehicle Equipment Bay (VEB)

The VEB functioned normally, apart from the failure of the two Inertial Reference Systems



**Figure 2. Lift-off of Ariane flight 501; the hot jet from one of the booster flame trenches is visible in this view**

(Photo, CSG for ESA/CNES)

and inversion of the membrane between the VEB and SPELTRA (multiple-payload-carrying structure) when the VEB compartment depressurised too quickly. A simple corrective measure has since been implemented in the ventings of the upper part of the launcher.

#### Upper stage – fairing – SPELTRA – payload adapters

There is no anomaly to report here, the flight being of such short duration that these elements were not put to a representative in-flight test.

#### Electrical system

The electrical system functioned satisfactorily overall, with only small anomalies being detected in the launcher-to-ground telemetry links at lift-off.

#### Ground-to-launcher interface – lift-off – trajectory

The various umbilical connectors performed nominally and were released correctly. Launcher wobble (about the vertical trajectory at lift-off) was very slight; the wind was also very light, at approximately 1.5 m/s. There was an

## The Inquiry Board's Recommendations

- R1 Switch off the alignment function of the inertial reference system immediately after lift-off. More generally, no software function should run during flight unless it is needed.
- R2 Prepare a test facility including as much real equipment as technically feasible, inject realistic input data, and perform complete, closed-loop, system testing. Complete simulations must take place before any mission. A high test coverage has to be obtained.
- R3 Do not allow any sensor, such as the inertial reference system, to stop sending best-effort data.
- R4 Organise, for each item of equipment incorporating software, a specific software qualification review. The Industrial Architect shall take part in these reviews and report on complete system testing performed with the equipment. All restrictions on use of the equipment shall be made explicit for the Review Board. Make all critical software a Configuration Controlled Item.
- R5 Review all flight software (including embedded software), and in particular:
- Identify all implicit assumptions made by the code and its justification documents on the values of quantities provided by the equipment. Check these assumptions against the restrictions on use of the equipment.
  - Verify the range of values taken by any internal or communication variables in the software.
  - Solutions to potential problems in the onboard computer software, paying particular attention to onboard computer switchover, shall be proposed by the Project Team and reviewed by a group of external experts, who shall report to the onboard-computer Qualification Board.
- R6 Wherever technically feasible, consider confining exceptions to tasks and devise backup capabilities.
- R7 Provide more data to the telemetry upon failure of any component, so that recovering equipment will be less essential.
- R8 Reconsider the definition of critical components, taking failures of software origin into account (particularly single-point failures).
- R9 Include external (to the project) participants when reviewing specifications, code and justification documents. Make sure that these reviews consider the substance of arguments, rather than check that verifications have been made.
- R10 Include trajectory data in specifications and test requirements.
- R11 Review the test coverage of existing equipment and extend it where deemed necessary.
- R12 Give the justification documents the same attention as code. Improve the technique for keeping code and its justifications consistent.
- R13 Set up a team that will prepare the procedure for qualifying software, propose stringent rules for confirming such qualification, and ascertain that specification, verification and testing of software are of a consistently high quality in the Ariane-5 Programme. Inclusion of external RAMS (Reliability, Availability, Maintainability, Safety) experts is to be considered.
- R14 A more transparent organisation of the cooperation among the partners in the Ariane-5 Programme must be considered. Close engineering cooperation, with clear-cut authority and responsibility, is needed to achieve system coherence, with simple and clear interfaces between partners.

acceleration deficit as the launcher left the platform – 4.4 m/s rather than the expected 5.3 m/s – which persisted until about H0+26 s. Thus, after 30 s of flight, the launcher's altitude was 100 m below the nominal figure and its velocity was Mach 0.53 rather than the predicted 0.56. These figures were, however, still within specification.

On engine ignition, overfilling with water of the booster flame trenches caused a blowback of the jet streams from the solid boosters, creating some minor damage to hardware (water is injected into the flame trenches shortly before lift-off to reduce the acoustic noise level to which the launcher is subjected). A simple modification has been devised, which is to delay the moment of water injection thereby reducing the volume at the bottom of the flame trenches, which on flight 501 partially blocked the flow of booster gases.

#### Flight control

Until failure of the Inertial Reference Systems at about 36.7 s, flight control performed nominally. As soon as a specified velocity was reached at 25.7 s, the guidance function was activated and flight control reacted nominally taking into account the slight under-performance of the launcher.

#### Aerothermodynamics – depressurisation – air cleanliness

Contamination inside the fairing was about 3 mg/m<sup>2</sup> at about 37 s (specification is 2 mg/m<sup>2</sup>); it can be assumed, based on Ariane-1 measurements, that this contamination would be eliminated once a vacuum had been created in the fairing.

#### Dynamic environment

The recorded blast wave over-pressure slightly exceeded specification for the fairing and the booster pallets. External acoustic noise values were slightly higher than expected at lift-off (when they are at their maximum), but were lower than expected when at an altitude of 50 m. Values at the Main Stage tail structure were as expected.

Internal acoustic noise values were lower than expected and below the interface specification for the SPELTRA structure and Vehicle Equipment Bay. For the fairing, certain internal measurements in the 31 and 63 Hz octaves were slightly above specification.

No signs of POGO effect (resonance caused by propellant flow through the feed lines) were measured at the Main Stage. As the Upper Stage had not started its propulsive phase,

absence of the POGO phenomenon there could not be confirmed.

Vibration levels on the stages were low, the only exception being the Vulcain engine gimbal where the specification was exceeded but was still acceptable at system level. The payload interface complied with the specification but the vibration levels recorded were 70 to 100 Hz higher than expected. The mathematical models will therefore have to be re-adjusted.

#### Environmental impact of the accident

One item that was fully qualified after the very unfortunate explosion of the launcher was the safety system, as well as its forecasts and computing models (debris impact zone, cloud dispersion model, absence of air toxicity beyond the safety limits). Explosion of the launcher at 4000 m altitude is one of the most hazardous scenarios imaginable as far as ground impact and hazardous cloud pattern are concerned.

In accordance with the French and international regulations applicable to industrial installations, a very detailed risk and impact analysis had been performed during the design, construction and testing phases of the Ariane-5 facilities at the Guiana Space Centre. An environmental measurement plan had already been implemented at each of the seven full-size booster test firings performed between 1993 and 1995. With the results of these measurements, the real impact on the natural environment (atmosphere, fauna, flora and water courses) could be determined, and the mathematical models of combustion-cloud dispersion and chemical fallout could be adjusted. The combustion gases from the solid boosters during Ariane-5's atmospheric flight include 21% (by mass) hydrochloric acid, 34% aluminium oxide, and 28% carbon monoxide and carbon dioxide. The Vulcain engine of the cryogenic main stage practically ejects only water vapour.

During the measurements of the natural state of the environment close to the Kourou facilities prior to each test, it was confirmed that, as elsewhere in the Amazonian ecosystem, the aluminium-oxide content in the ground and natural waters (between 4% and 35%), and the water acidity (PH values between 4 and 6), are particularly high.

For Ariane flight 501, more than 100 sensors were installed around the launch pad and as far afield as the towns of Kourou (15 km to the southeast) and Sinnamary (25 km to the northwest). They analysed both the air (mainly

for hydrochloric acid) and the water (inside the pad's flame trenches and in the rivers). The results show that the hydrochloric-acid and aluminium-oxide fallout occurred within a 500 m radius of the launch pad. No gaseous pollution at ground level was detected by any of the measuring instruments outside the launch area. The cloud produced by the explosion and the plume of exhaust gases immediately moved parallel to the coast, and were monitored by helicopters until three hours after the accident, by which time they were several kilometres off the coast and dissipating gradually.

On the ground, several types of gases were monitored: the lift-off cloud, some still-burning solid-propellant fragments from the boosters, and the vaporisation of launcher and spacecraft propellants. These gases rose and headed towards the sea, at an altitude of more than 1000 m (Fig. 3).

### Fragment fallout and recovery

The so-called 'Internal Operations Plan' (a legally-imposed and periodically rehearsed safety plan) was initiated immediately after the launcher's explosion. Among other procedures, it triggered a computer-aided estimation of the exact debris fallout zone by the Flight Safety Team, taking into account the launcher's position and velocity at the time of the explosion, as well as the wind pattern, which varies with altitude.

Some hours after the explosion, fragment-locating operations started. The whole of the affected area was systematically photographed and mapped. The positions of all items were fixed using the GPS system and were found to be well within the pre-computed impact zone. The heaviest fragments had landed in the savannah and marshland between 1 and 2 km east of the launch pad. Lighter pieces had 'flown' for some minutes and landed further away, influenced by the mainly northwesterly wind, but did not represent a hazard (Fig. 4). Some of the solid-propellant fragments continued to burn on the ground, causing very localised savannah fires. The vegetation affected is recovering rapidly and no impact on the indigenous fauna has been detected, confirming similar observations made after the static firings of the boosters.

Fragment-recovery operations were started immediately thereafter and involved almost one hundred people (safety engineers and technicians, firemen, security guards, and legionnaires) over a period of several weeks. Helicopters and special amphibious vehicles were deployed. Priority was given to recovering first those parts relevant to the failure investigation, including the two inertial reference units and the onboard computers. Carefully respecting the safety rules (avoiding explosion, fire or release of hazardous materials), the majority of the more accessible items,

**Figure 3. The cloud produced by the explosion and the plume of exhaust gases immediately moved away, parallel to the coast, and were monitored by helicopters until three hours after the accident. By this time, they were several kilometres offshore and dissipating gradually.**  
(Source: CNES/CSG)

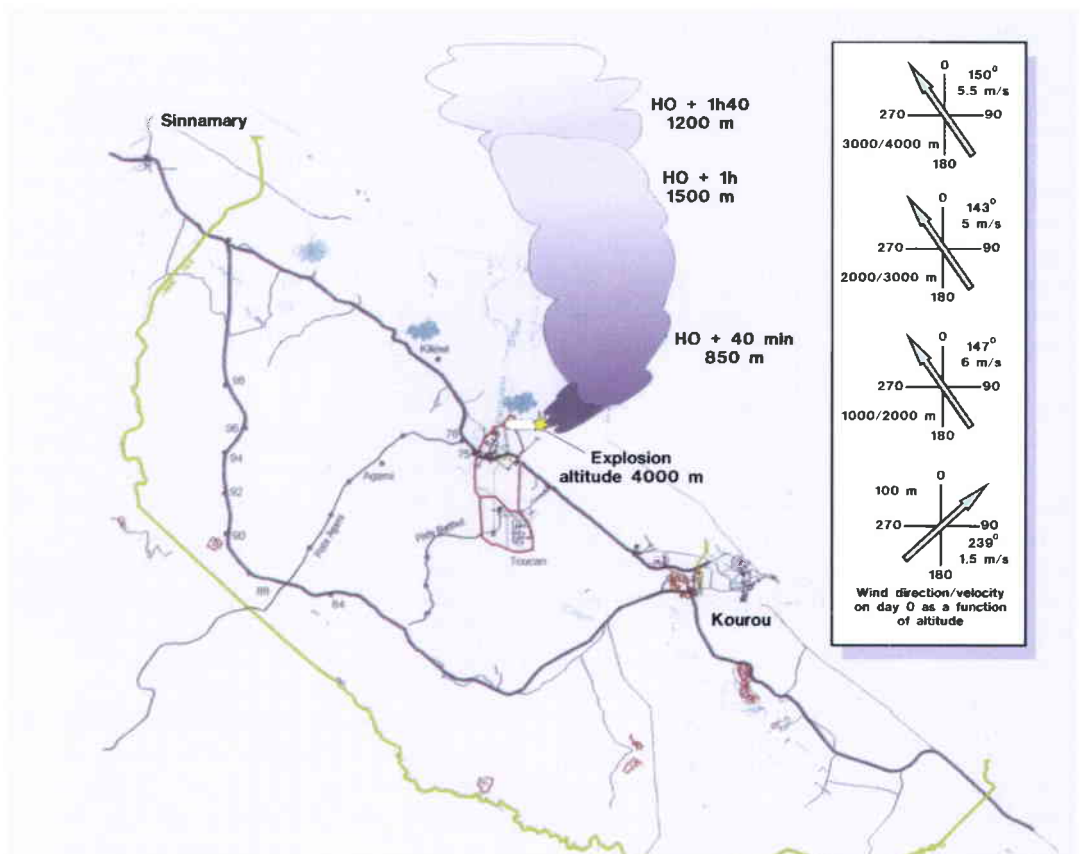
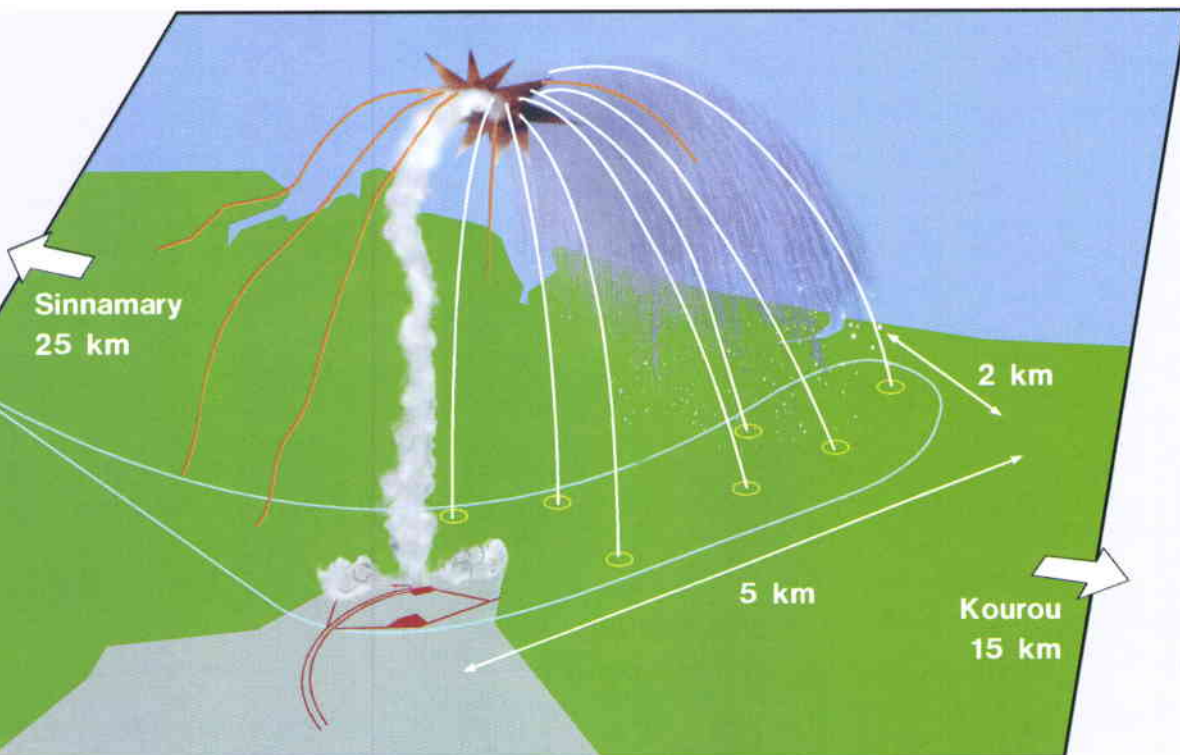

Figure 4. The fragment fallout zone shown on this drawing was well within the Flight Safety Team's estimated area. The dotted lines represent the trajectories followed by the heaviest fragments

(Source: CNES/CSG)



including the solid-propellant fragments, were also recovered as quickly as possible. Most elements of the four Cluster satellites were also recovered (Fig. 5) and returned to ESTEC in Noordwijk (NL) for inspection, but unfortunately none were still flightworthy.

**Plan of action leading to flight 502**

The main findings of the Inquiry Board show that the 501 flight failure was due to design faults in the software embedded in the Inertial Reference System (SRI):

- maintenance after lift-off of pre-launch function (alignment mode) incompatible with flight
- saturation, in this mode, of capacity to represent a variable
- shutdown of processor on detection of a malfunction.

These anomalies had not been brought to light by all of the various programme tests and reviews, which had otherwise proved effective. The ground/flight mode interface had been inadequately identified. Furthermore, testing at equipment and system levels had been insufficiently representative. However, the overall Ariane-5 architecture is not called into question.

All of the Inquiry Board's recommendations have been transformed into a plan of action comprising over 40 detailed items, classified according to the various firms and hardware items concerned. The plan's main thrusts are:

- correction of the SRI problem that led to the failure



Figure 5. Recovery work in progress at the impact site of one of the Cluster spacecraft (Photo: CSG)

- re-examination of all software embedded in equipment
- improvement of the representativeness of the qualification-testing environment
- improvement and systematisation of the flow of information: from equipment to system, on the basis of detailed nominal/failure mode behaviour, and from system to equipment, by defining in-flight use of equipment (normal and degraded trajectories).

Detailed actions prompted by the Inquiry Board's findings are summarised in the accompanying panel.

Additional actions to those prompted by the Inquiry Board's findings are also being taken:

- verification/possible improvement of all justification documents for the system, stages and their constituent parts
- setting-up of specialised audits of certain subjects
- continuation with launcher development and further qualification for elements qualified only in flight-501 configuration, taking into account the actual characteristics of the hardware used and the actual mission.

## Actions Prompted by the Inquiry Board's Findings

### *SRI*

- switch-off of alignment mode after lift-off
- no processor shutdown in flight
- testing to check possible SRI flight domain.

### *System qualification environment (functional simulation facility)*

- general improvement of representativity through systematic use of real equipment and components wherever possible
- simulation of actual trajectories on SRI electronics.

### *Programme*

- systematic critical reappraisal of all software (flight programme, embedded software, ground software interfacing with launcher)
- review of mechanisms for managing double failures (possibility of continuing mission in degraded mode where both items of equipment malfunction).

### *Improvement of overall coordination relating to software*

- treating the software embedded in equipment as separate Controlled Configuration Items and involving all programme bodies (Industrial Architect in particular) in monitoring its development (reviews, etc.)
- re-defining the rules for qualifying this software
- exhaustively cataloguing all information likely to flow through the communication bus between the onboard computer and the equipment.

### *Improved assessment of flight data*

- several modifications have been introduced into the telemetry acquisition and retrieval system.

All these actions must be completed before flight 502 in order to guarantee a successful outcome with maximum confidence.

### **Improvement of working methods**

The Inquiry Board advocated (Recommendation No. 14) a more transparent organisation, closer engineering cooperation, and clear-cut authority and responsibility among the partners in the Ariane-5 Programme.

In the past, hardware equipment was considered as a whole and treated as single Configuration Controlled Item. Thus, the embedded software was not studied in the same detail and showed up only in the functional specifications which the hardware equipment was required to meet. The detailed design and functional impact on other pieces of software elsewhere in the vehicle was insufficiently known. It was therefore decided to formally establish the role of 'Software Architect', a responsibility that has since been discharged by the Industrial Architect, given the need to understand properly how the software functions both in the electrical/computing-system environment and in the launcher-system environment. A revised Management Specification (A5-SM-0-10, industrial organisation) has been issued to strengthen the Industrial Architect's role regarding embedded software. The Industrial Architect is now involved in the reviews held at various points in the development of each software-containing component, and approves, as does CNES, its definition and qualification plan.

The software programmes embedded in the hardware equipment will also be considered as Configuration Controlled Items and, as such, the Industrial Architect is required to:

- approve their specifications
- participate in their development and qualification reviews
- approve the qualification plan
- verify the system implications of their use
- ensure that the general specifications for software are applied.

The project reviews – Preliminary Design Review, Critical Design Review and Qualification Board – also draw on outside software experts.

For the already developed Ariane-5 onboard software, the post-501 plan of action has foreseen exhaustive verification in the form of qualification reviews (after registering all software flight-domain limitations, failure modes and information likely to flow through the communication bus between the equipment and the onboard computers) in order to gain a better understanding of all possible system functioning modes.

The Industrial Architect also has overall responsibility for the Electrical and Software System (SEL), and in particular:

- the SEL qualification plan
- the SEL requirement-verification plan
- the system-level tests
- the SEL justification document (demonstrating qualification).

An exhaustive verification, involving all of the launcher's constituent hardware, of the applicability and actual application of the general system specifications has been undertaken, in order to check that no system aspect has been overlooked in developing this hardware.

The Qualification Board was given the mandate to set up specialised audit groups to study any aspect it considered critical. Each audit group is headed by a member of the Qualification Board, and draws on outside experts in the area concerned. This approach has the dual advantage of drawing together the necessary expertise and judging, in depth, the suitability of the work done and the validity of programme documentation issued.

### Development plan

As far as the aforementioned action plan is concerned, significant progress has already been made in four primary domains:

- Modifications to the Inertial Reference System have been completely defined. They include: suppression of in-flight operation of the alignment platform; masking of underflows in the mathematical processor; freezing of functional values at the last valid values in the case of processor shutdown; modification of the handling of exceptions in order to avoid processor shutdown; improvement of address contents describing failure; suppression of all functions not used during flight. All of these modifications have been coded and tested at unit level. Their validation at system level is planned using the Functional Simulation Facility.
- The Functional Simulation Facility has been completed with interfaces allowing tests to be run with: an actual Inertial Reference System's processor; an upper-stage mockup made up of its structure, engine and electrical actuators; a gyrometric platform mounted on a turntable; an attitude-control mockup and Main Stage electro-valves.
- The flight programme has been improved: analysis of redundancy logics in the Inertial Reference System has been completed, and treatment of acceleration measurements and degraded modes has been improved. An analysis of double-failure management has resulted in an improvement in flight reliability: automatic countdown hold will now be possible until  $H0 + 7$  s (instead of  $H0 - 3$  s in the past), in case an equipment fault is detected during the Vulcain ignition sequence. Analysis of functions not needed during flight has been completed.

- Software analysis at system level has been completed and has not indicated any fundamental problem. Several improvement actions have, nevertheless, been decided. In particular, the back-up onboard computer's processor will not be shut off in the event of an anomaly.

More or less independent of the flight-501 failure, further qualification is required for a number of improvements which, for schedule or other development-constraint reasons, could not be built into the 501 vehicle and are thus being introduced for the first time on flight 502. The main improvements involve:

- Lengthening of the booster nozzles by 45 cm to provide a performance increase of some 100 kg to Geostationary Transfer Orbit (GTO).
- Lightening of the upper structures compared to the 501 configuration. This modifies the distribution and intensity of load fluxes and needs mechanical testing on the ground. To ensure that a more exhaustive approach is taken at system level, the upper section is progressively tested until rupture. The test involves the Main Stage's forward skirt, the Vehicle Equipment Bay and the Storable Propellant Stage.
- To increase the operating margin of the Vulcain engine, its hydrogen-turbopump interstage diffusers have been reinforced. This modification was initially planned for later, but a series of qualification tests on this design improvement have already logged a cumulative operating time of 4700 s, equivalent to more than seven times the normal flight time.

The flight-502 Vulcain engine, with the improved hydrogen turbopump, was delivered in November 1996, and integration of the Main Stage was well underway at the time of writing (mid-December).

Mid-March 1997 will be the key date for delivery to the Guiana Space Centre (CSG) of the remaining flight-502 hardware, including:

- the Vehicle Equipment Bay, the SPELTRA (multiple-launch carrying structure) and the fairing
- the Main Cryogenic Stage and the Upper Stage, and
- the two solid-propellant boosters.

The Flight-Readiness Review will take place on 18 and 19 March, with the launch campaign planned to begin at CSG on 7 April. The Launcher Countdown Rehearsal will take place on 21 May, to be followed by the

Launch-Readiness Review on 4 and 5 July 1997.

The Ariane-502 launch date is closely linked to the calendar of the flight programme modifications, their development and, most importantly, their validation tests. Analysis of this workload is still in progress and the launch date will only be confirmed on satisfactory completion of the validation testing, but the objectives set in mid-December 1996 included a target launch date of 8 July.

**The Ariane-502 mission**

Since flight 501 did not validate the GTO mission, it has been decided to use flight 502 to qualify the launcher's nominal mission, namely a dual launch into GTO. This means that flight of the Atmospheric Re-entry Demonstrator (ARD), which cannot be launched with a standard GTO mission since it requires a specific 'en-route jettison manoeuvre' at the end of the main-stage burn, has to be postponed until flight 503. The 502 passengers will therefore be the AMSAT-P3D radio-amateur satellite and two technology-demonstration mockups.

The APEX (Ariane Payload EXperiments) configuration inside the upper part of the vehicle is shown in Figure 6. The upper mockup weighs 2000 kg and includes a 350 kg payload known as 'TEAMSAT,' which is composed of five experiments proposed by various European Universities and coordinated by ESTEC:

- Visual Telemetry System, composed of several cameras with an image compression and storage unit.
- Flux Probe Experiment, to measure low concentrations of atomic oxygen in Earth orbit which are known for their erosion effects and degradation of optical surfaces and lenses.
- Autonomous Vision System, to track and observe a non-star target for navigation and imaging purposes.
- Orbiting Debris Device, for the calibration of radar and optical instruments used for space-debris tracking, and to study surface-paint degradation.
- Young Engineers Satellite, designed to study the behaviour and controllability of a tether system in GTO, and composed of two subsatellites with masses of 120 and 20 kg, linked by a 20 km tether, to be deployed after launch.

mated to the lower mockup, weighing 1800 kg. The satellite and a Special Bearing Structure (SBS) have both been developed by the international AMSAT organisation. The SBS has been designed to carry a larger payload on its top, thereby creating a generic launcher-to-spacecraft interface adapter and separation system for payloads in the 500 to 1000 kg class as secondary passengers, but it will not be used for this purpose on Ariane-502.

AMSAT-P3D's main mission objectives are to:

- serve, throughout its more than 10 year lifetime, as an educational aid by enabling students worldwide to familiarise themselves with space techniques and communications on a first-hand basis
- establish backup communications networks over very long periods covering a large

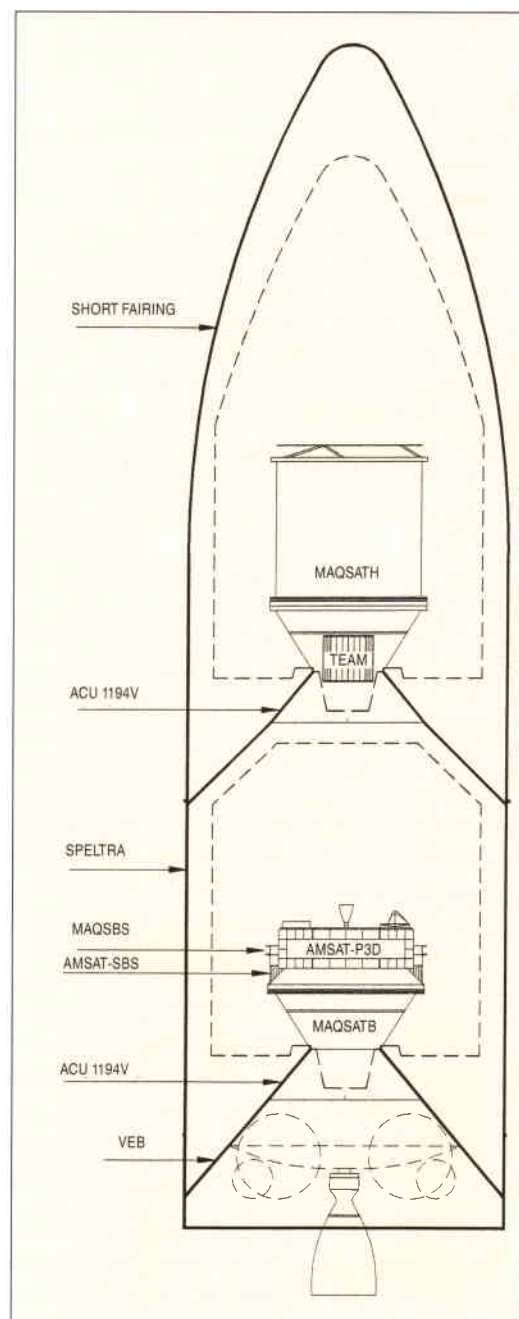

**Figure 6. The planned Ariane-502 payload configuration**

In the lower position inside the SPELTRA, the 550 kg AMSAT-P3D satellite (Fig. 7) will be



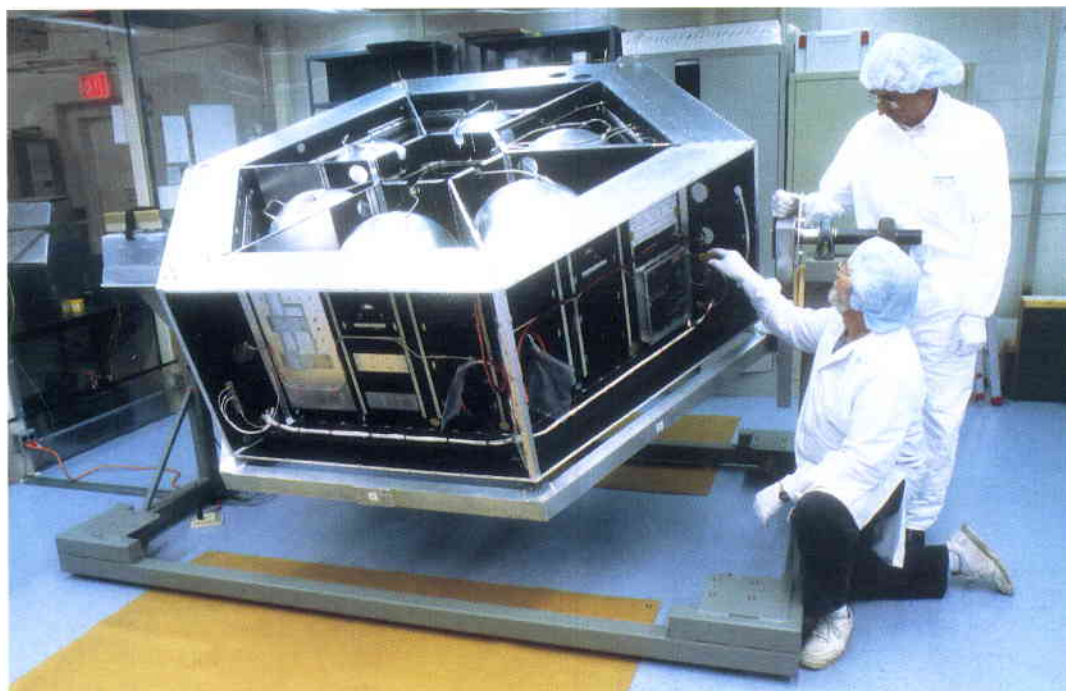

**Figure 7. The AMSAT-P3D international radio-amateur satellite undergoing final preparations in Orlando, Florida**

(Photo: L. Mulvehill/CQ VHF Magazine)

portion of the Earth, using simple and inexpensive equipment

- study the technological aspects of a multiple-access transponder and the associated operational procedures when using the Frequency Division Multiple-Access (FDMA) technique
- assess the effectiveness of a highly eccentric 16 h orbit for long-distance, point-to-point communications
- demonstrate the practicality of using GPS onboard for managing and monitoring the satellite's operation
- establish low-cost three-axis control using magnetically suspended reaction wheels.

In order to achieve the above objectives, AMSAT-P3D's final orbit will have a perigee of 4000 km, an apogee of approximately 50 000 km, and an inclination of 60 deg.

### The Ariane-503 mission

Since two successful test flights are necessary to demonstrate full qualification of Ariane-5, flight 503 will also form part of the qualification process. The planned payloads are the Atmospheric Re-entry Demonstrator (ARD) mentioned above, a technology-demonstration capsule for a future European manned space transport vehicle, and a commercial payload. The 503 launch is expected to take place approximately five months after flight 502, to allow sufficient time for a full evaluation of the 502 flight data, for the launcher's shipment to French Guiana, and for the launch campaign itself. 

## AMSAT

AMSAT is a worldwide group of radio-amateurs who share an active interest in building, launching, and then communicating with each other using non-commercial radio-amateur satellites. Since its initial founding in the USA more than 25 years ago, AMSAT has predominantly used volunteer labour and donated resources to design, construct and, with the assistance of government and commercial space agencies, successfully launch over two dozen radio-amateur communications satellites into Earth orbit. The AMSAT-P3D programme is managed by AMSAT-DL (Germany), whilst the integration and testing work is being performed by AMSAT-NA (USA). Groups in these two countries are providing the spacecraft and mission design, platform structure, and much of the spacecraft's equipment. Other hardware items (mainly transmitters and receivers) are being provided by radio-amateur groups in over a dozen countries on five continents, forming a unique international team of volunteers who make a remarkable contribution to the advancement of space communications, space education and the space sciences.

# Capsule ARD – Essai en vol de la phase terminale de la mission

**C. Cazaux & B. Tatry**

Projet ARD, ESA/CNES, Toulouse, France

L'Europe veut ainsi démontrer sa capacité de lancement, de maîtrise du guidage et pilotage pendant la rentrée et de récupération d'une capsule non habitée dans un environnement représentatif des futures conditions opérationnelles d'une capsule CTV habitée.

Préalablement au vol de l'ARD, la chaîne de parachutes destinée à freiner la vitesse de retombée de la capsule à la fin de la phase de rentrée atmosphérique et le système de flottaison ont été qualifiés par un essai en vol fonctionnel spécifique qui a eu lieu le 14 juillet 1996 et qui est décrit ci-après.

---

**Le programme ARD (Atmospheric Reentry Demonstrator) est un programme de l'ESA placé sous maîtrise d'oeuvre de la société Aérospatiale.**

**Ce programme a pour objectif d'effectuer une rentrée dans l'atmosphère avec une capsule spatiale et de la récupérer. Cette capsule a une forme type capsule Apollo, de diamètre 279 mm, hauteur 2037 mm et masse 2800 kg. L'ARD sera lancé par Ariane-5 (vol 503) sur une orbite rentrante avec une pente de rentrée voisine de  $-3^\circ$  à 120 km d'altitude, et récupéré dans l'Océan Pacifique (près des îles Christmas).**

---

L'objectif de l'essai en vol était la qualification fonctionnelle du sous-système Descente et Récupération. Ce sous-système, dont le développement a été confié à la société Alenia, avec Irvin-USA pour les parachutes, Irvin-Italie pour les ballons de flottaison et Swedish Space Corporation pour la caméra, est constitué des éléments suivants (Fig. 1):

- le parachute mortier (petit parachute éjecté au début de la séquence parachute par une charge pyrotechnique commandée par un BSA - boîtier de sécurité armement), installé dans le capot de protection et de fermeture du compartiment de stockage (canister) des parachutes, et relié à ce capot par une bride;
- le capot de protection, qui supporte le mortier, fixé à la capsule par trois boulons à

cisaillage pyrotechnique commandés par un BMS (boîtier mécanique de sécurité), et relié au parachute drogue;

- le parachute drogue équipé d'un étage de reefing, relié à la capsule par deux brides et relié aux parachutes principaux;
- les trois parachutes principaux, chacun avec deux étages de reefing, reliés à la capsule par deux brides;
- la structure cylindrique du canister qui contient les parachutes principaux et le drogue. Cette structure est boulonnée dans sa partie haute au cadre supérieur de la structure conique primaire de l'ARD. La structure canister assure une partie de l'étanchéité de l'enceinte interne de la capsule, l'intérieur du canister étant en communication avec l'espace externe par des événements situés sur le capot;
- les deux ballons cylindro-sphériques de flottaison reliés à la capsule par des brides;
- les trois bouteilles de gaz hélium servant au gonflage des ballons;
- une caméra vidéo située dans la partie supérieure du canister qui filme la séquence de déploiement des parachutes drogue et principaux et la descente jusqu'à l'amerrissage;
- une balise Sarsat pour aide à la récupération;
- des capteurs (d'effort, de contact, de température...).

Cette qualification fonctionnelle devait être réalisée dans des conditions reproduisant le plus possible les conditions réelles et dimensionnantes de la dynamique du vol de l'ARD. Les paramètres essentiels en découlant étaient:

- la pression dynamique comprise entre 5000 et 5500 Pa;
- la vitesse proche de Mach 0,8 mais ne dépassant pas cette valeur;
- l'altitude qui en résulte au-dessus de 10 km.

A partir de ces spécifications, l'essai fonctionnel a été défini. La solution retenue consistait à

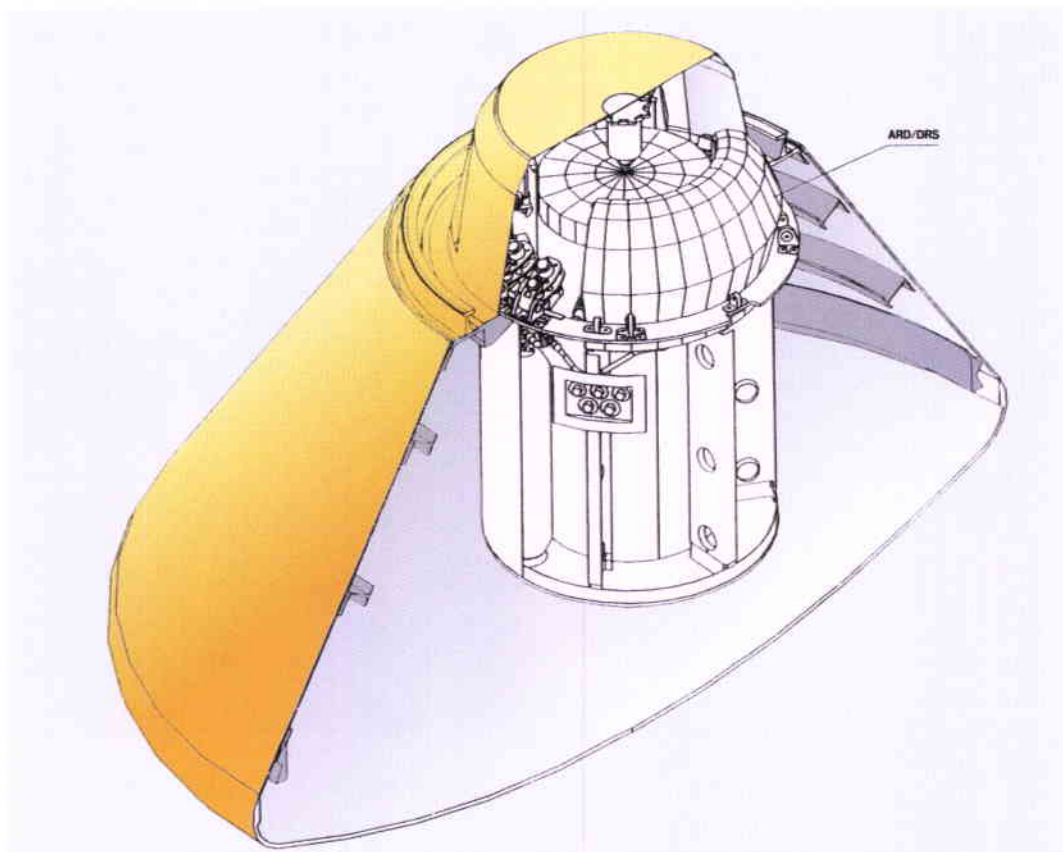

Figure 1. Le sous-système 'Descente et Récupération' (DRS) dans la capsule ARD

effectuer un lâcher d'une capsule à l'échelle 1 à partir d'un ballon stratosphérique, suivi d'une chute libre permettant d'atteindre la dynamique du vol spécifiée, suivie de la phase fonctionnelle comportant la séquence des parachutes et l'amerrissage.

Cet essai a été placé sous la responsabilité de la société Alenia, qui a utilisé les services de la base de lancement de ballons stratosphériques de l'Agence spatiale italienne (ASI) à Trapani (Sicile).

En partant des contraintes majeures de cet essai de qualification fonctionnelle, les caractéristiques et la séquence mission suivantes ont été définies :

- La capsule ARD est simulée par une maquette à l'échelle 1, avec une forme aérodynamique strictement identique au modèle de vol. Cette maquette est constituée d'une structure simple avec des poutres acier et une peau externe en résine fibre de verre; cette peau présente la forme exacte de l'ARD et assure l'étanchéité (pour la flottaison uniquement).

Cette structure accueille:

- un modèle de vol complet du sous-système Descente et Récupération (ce modèle de vol a subi préalablement à l'essai une qualification mécanique de niveau système représentant le lancement);

- un séquenceur jouant le rôle du calculateur de vol et générant les commandes des différentes séquences;
  - des capteurs supplémentaires de paramètres de vol (pressions, températures, accéléromètres, gyromètres, inclinomètres, capteurs de déplacement, micro-contacts...);
  - un enregistreur de bord à état solide et un système de télémessure bande-S pour les paramètres nécessaires à l'exploitation;
  - des batteries;
  - un système de vanne d'évent permettant d'assurer l'équilibre des pressions externe et interne et l'étanchéité après amerrissage.
- Altitude de lâcher de la capsule: entre 23 et 24 km.
  - Conditions de lâcher:
    - incidence :  $<5^\circ$
    - rotation en tangage :  $<1^\circ/\text{s}$
    - lâcher au-dessus d'une zone prédéfinie garantissant un retour de la capsule dans une zone de sécurité pour tous les cas nominaux ou dégradés de la mission.
  - Au lâcher, démarrage séquence d'essai, mise en route caméra, enregistreur...
  - Phase de chute libre permettant d'atteindre les paramètres de dynamique du vol rappelés ci-dessus.
  - La capsule ne disposant pas du système nominal de contrôle d'attitude, un dispositif de stabilisation constitué d'une masse sus-

**Figure 2. La capsule et sa masse de stabilisation en configuration de lancement (suspendues à la nacelle)**

pendue par trois élingues munies chacune d'un amortisseur est utilisé (Fig. 2). Ce dispositif est déployé dès le lancement du ballon pour atteindre sa position nominale (masse suspendue à environ 5 m du bouclier capsule). Il permet de maintenir les oscillations en tangage et lacet pendant la chute libre en dessous de 40°, compte tenu des conditions de lâcher, des dispersions sur le centrage, les inerties et les coefficients aérodynamiques, et des perturbations atmosphériques (rafales de vent). Ce système est largué par coupure pyrotechnique 0,8 s avant le démarrage de la séquence parachute (tir du mortier), déclenché par le séquenceur à un temps préprogrammé au sol de l'ordre de 50 s après le temps  $t_{\text{lâcher}}$ , ce qui correspond à une altitude moyenne théorique de 15 km.

- Tir du mortier commandé par le séquenceur embarqué à  $t_{\text{lâcher}} + 50$  s.
- Poursuite de la séquence parachute commandée par le séquenceur (séparation du capot, déploiement parachutes drogue puis principaux).
- Mise en incidence de la capsule par coupure pyrotechnique d'une des deux brides de suspension de la capsule aux parachutes principaux. Cette mise en incidence a pour but de limiter l'amplitude du choc à l'amerrissage.
- A l'amerrissage détecté par un capteur de choc, coupure pyrotechnique de la deuxième bride de suspension pour désolidariser les parachutes de la capsule et les laisser couler.
- Démarrage du gonflage des ballons de flottaison et fermeture de la vanne d'évent par commande du séquenceur.

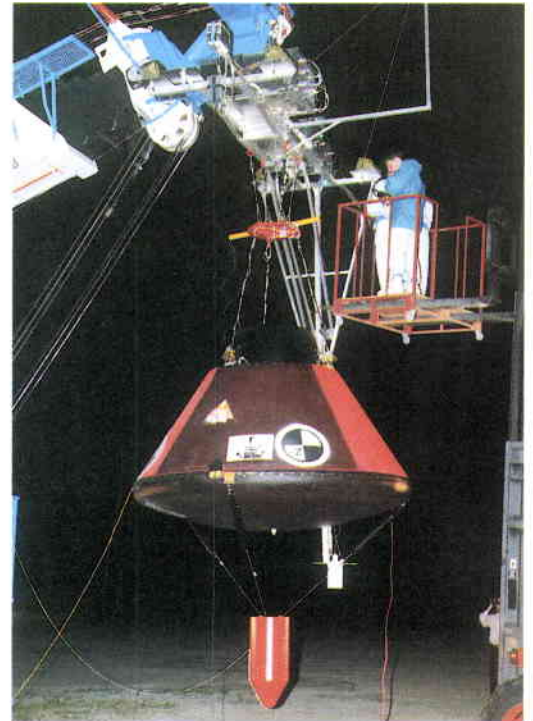

- Arrêt de l'essai en vol. La balise Sarsat autonome continue à émettre.
- Récupération de la capsule par un navire.

La mise à poste de la capsule est effectuée par un ballon stratosphérique selon une séquence adaptée au site de lancement et à son expérience passée. La base de lancement de Trapani est située à la pointe de la côte ouest de la Sicile. Pendant les premiers mois de l'été, les conditions atmosphériques offrent des vents d'altitude (au-dessus de 18 km) vers l'Ouest, donc vers la mer où une zone de sécurité peut être définie. Un ballon lancé de cette base va donc commencer une ascension avec une dérive le plus souvent vers l'Est, puis atteindra l'altitude d'inversion des vents et partira vers l'Ouest.

A l'aide des simulations effectuées avec les données statistiques de la météorologie de cette région, une enveloppe de trajectoires a été définie, permettant d'atteindre avec une bonne probabilité un point de largage de la capsule situé au-dessus de la mer et dans une zone de sécurité démarrant à 80 km environ de la côte de Trapani. Par ailleurs, dès le début de la campagne, des sondages journaliers ont donné le profil vitesse/direction des vents en fonction de l'altitude.

La configuration de lancement suivante a été retenue :

- un ballon stratosphérique rempli à l'hélium (Fig. 3), de volume 104 546 m<sup>3</sup>, avec deux manches d'évent permettant après ascension de garder une altitude constante (dans notre cas entre 23 et 24 km);



**Figure 3. Remplissage du ballon à l'hélium**

- une chaîne de vol ballon classique comprenant en dessous du ballon un parachute de secours (permettant de récupérer l'ensemble nacelle et capsule en cas de défaillance du ballon), une nacelle avec équipements TM/TC, sonde Vaisala, répondeur radar, GPS, équipement Omega, ballast réglable par TC, système pyrotechnique de séparation de la charge utile, capteurs de pression et de température, batteries...;
- la capsule maquette ARD avec son dispositif de stabilisation;
- des moyens sol:
  - la station TM/TC de la base de Trapani;
  - une station de réception TM de la capsule, installée par Aérospatiale à côté de la station ASI, pour enregistrer et visualiser en temps réel les informations de la séquence parachute .

L'ensemble de la chaîne de vol avait les caractéristiques suivantes (Figs. 4 et 5):

- longueur totale au lancement: un peu plus de 200 m
- masses:
 

ballon	928 kg
chaîne et nacelle	690 kg
ballast	480 kg
capsule + stabilisateur	2805 kg
<b>Total:</b>	<b>4903 kg</b>
- en considérant une force ascensionnelle nécessaire de 10%, la force ascensionnelle totale nécessaire était de 5393 kg, valeur qui a servi à calculer la masse d'hélium nécessaire.

La revue avant essai a été effectuée les 5, 6 et 7 juillet 1996. Les opérations de lancement du ballon ont commencé dans la nuit du 13 au 14 juillet, après quelques jours d'attente de conditions météorologiques parfaites (faibles vents au sol et vents vers l'Ouest en altitude bien établis).

Le lancement du ballon a pu être effectué le 14 juillet vers 8 heures locales. L'ascension s'est déroulée parfaitement avec une faible dérive vers l'Est, puis une dérive nominale vers l'Ouest et enfin une prise de plafond parfaite à 23 200 m, ajustée par un lâcher de ballast de 50 kg.

L'ordre de largage de la capsule a été envoyé dès que la zone de sécurité a été survolée.

La capsule a effectué une chute libre stabilisée suivie du largage stabilisateur et de la séquence parachute, puis flottaison. La capsule a ensuite été récupérée par le bateau de récupération guidé par la localisation du réseau Sarsat (FMCC-CNES à Toulouse) qui a fourni entre 11h02 et 12h58 quatre localisations très utiles.

Après retour de la capsule à Alenia (Turin) et exploitation des données TM, enregistreur et caméra embarquée, et inspection de la capsule, les résultats de cet essai de qualification sont les suivants:

- lâcher à une altitude de 23 168 m (spécification entre 23 et 24 km);

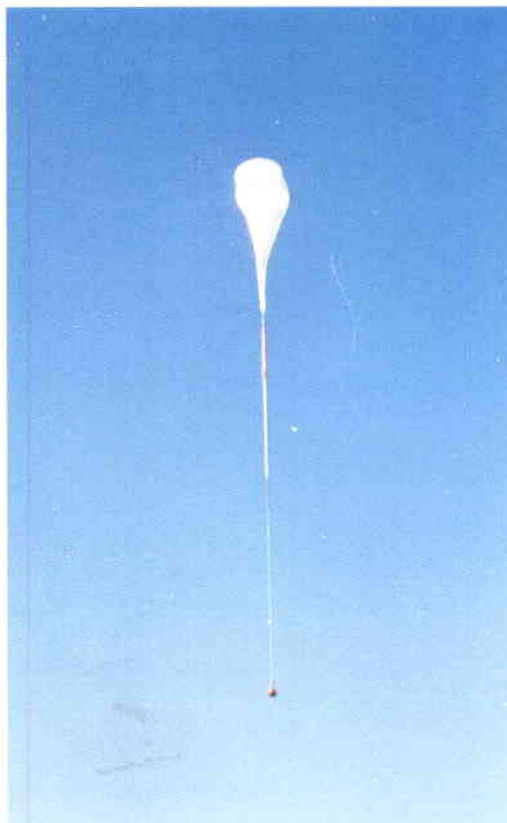
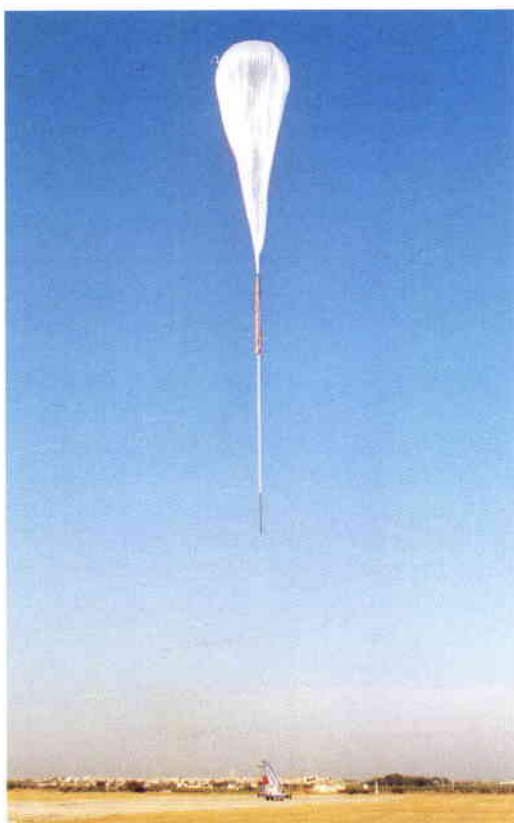

**Figure 4. Chaîne de vol accrochée à la grue de lancement juste avant lancement**

**Figure 5. Chaîne de vol au début de l'ascension**

**Figure 6. Capsule en flottaison, en cours de récupération**



- à l'instant du tir mortier ( $H = 14,7$  km):
    - $P_{dyn} = 5336$  Pa (entre 5000 et 5500 spécifiés)
    - $M = 0,75$  ( $M \leq 0,8$  spécifié)
    - rotation tangage au lâcher:  $< 1^\circ/s$  (spécification idem)
    - rotation tangage en fin de chute libre (après stabilisation) au moment du tir mortier:  $10^\circ/s$  et une incidence  $\leq 40^\circ$  (spécification  $15^\circ/s$  et  $40^\circ$ );
  - génération nominale des commandes du séquenceur et accomplissement de ces commandes;
  - séparation correcte du stabilisateur;
  - largage de la capsule et récupération dans la zone de sécurité selon les simulations avant lancement, vitesse d'impact inférieure à  $6,8$  m/s, flottaison capsule en position verticale nominale, capsule étanche (Fig. 6);
  - système de flottaison nominal (ballons gonflés, antenne Sarsat déployée et balise/flash lumineux en marche);
  - comme prévu, les parachutes, séparés de la capsule après l'amerrissage, ont coulé avant l'arrivée du bateau de récupération (élément de sécurité pour la récupération);
  - la capsule et ses équipements ont très bien supporté la mission, notamment l'amerrissage;
  - les paramètres de télémétrie ont été enregistrés à bord;
  - les images de la caméra embarquée montrent un déroulement quasi nominal des phases parachutes et flottaison,
- été prises en compte pour le modèle de vol ARD :
- cordes reefing des parachutes drogue et principaux choisies avec une résistance doublée (453 kg);
  - laçage des sacs des ballons de flottaison et des attaches du capuchon antenne Sarsat amélioré;
  - contrôles à l'intégration (orientation des ballons de flottaison) à renforcer.

L'exploitation des données du vol est en cours. Les premiers résultats indiquent:

- une charge à l'ouverture drogue de  $76$  kN environ (due à la défaillance de l'étage de reefing), contre respectivement  $41$  et  $46$  kN pour la séquence avec reefing, ce qui démontre une excellente robustesse du drogue;
- une charge à l'ouverture des parachutes principaux de l'ordre de  $94,9$  kN ( $87,5$  kN estimés) due à une défaillance du premier étage de reefing de l'un des trois parachutes. Les séquences de dereefing suivantes ont induit des charges de l'ordre de  $32,4$  et  $68$  kN, proches des valeurs estimées ( $42$  et  $68,4$  kN) respectivement;
- des vitesses de descente proches des valeurs estimées et une durée de descente totale de  $924$  s ( $930$  s estimés);
- l'adéquation des modèles de simulation utilisés.

Avec la prise en compte des modifications mineures issues de l'essai, celui-ci a été considéré comme qualifiant complètement le sous-système Descente et Récupération de l'ARD.

Les anomalies mineures rencontrées pendant l'essai ont fait l'objet de modifications qui ont

# The Monitoring of Gaseous Contaminants in Spacecraft Cabin Atmospheres

**G.B.T. Tan & C.J. Savage**

Thermal Control and Life-Support Division, European Space Research and Technology Centre (ESTEC), Noordwijk, The Netherlands

**H. Bittner**

Kayser-Threde GmbH, Munich, Germany

## Introduction

A major concern during manned spaceflight is the quality of the cabin atmosphere. In particular, the crew could be endangered by the uncontrolled accumulation of gaseous trace contaminants arising, for example, from off-gassing (from structural materials, electronic equipment or materials used in experiments, etc.), from system failures (leaks, equipment over-heating, fires, etc.), or from the crew itself (metabolic products).

---

**The accumulation of toxic or otherwise harmful trace gases in a spacecraft cabin is a very serious concern in terms of the health and safety of the crew. Although methods exist for controlling the evolution of such contaminants, techniques for monitoring the success of these methods, on board and in near-real-time, are still under development. One such technique, based on the use of FTIR interferometry, is being developed in Europe.**

**A prototype instrument has been assembled, making extensive use of 'off-the-shelf' hardware and software, and tested for its ability to detect and quantify – within a maximum period of 1 minute and in the presence of water vapour and carbon dioxide – 21 of the most frequently detected contaminants on past Shuttle and Spacelab flights. Results have confirmed that such contaminants can be detected and measured with an acceptable degree of precision.**

---

To ensure a safe atmosphere at all times, these trace gases need to be monitored and controlled so that they remain below certain safe limits. These limits are known as SMAC – Spacecraft Maximum Allowable Concentration – values and have been defined as a result of medical considerations, previous spaceflight experience and analogous terrestrial experiences such as in submarines and during saturation diving. SMAC values vary considerably according to the chemical compound considered but, within a normal atmosphere, they are typically measured in parts per million (ppm) or even parts per billion (ppb). SMAC values also vary as a function of the mission's length (time of exposure), higher

SMACs generally being tolerable during shorter missions. The ESA Atmosphere Quality Standard, PSS-03-401, contains a typical SMAC list, but these lists are continually being reviewed (extended and updated) in the light of new experience.

The strategy that has been adopted to date for the management of trace contaminants, for example in Spacelab, is basically to minimise the off-gassed products in the atmosphere by the careful selection and cleaning of materials, and to size the contamination control system with a sufficient margin to ensure that SMAC values will not be exceeded. The actual monitoring of trace gases is limited only to the most toxic or explosive ones such as carbon monoxide and hydrogen. The major atmospheric constituents, nitrogen, oxygen, water vapour and carbon dioxide, are not regarded as trace gases and are monitored by dedicated sensors.

A very similar strategy is followed for the Mir space station, although in addition air samples are taken periodically in bottles for eventual analysis on the ground. This detailed offline analysis provides trend information only and cannot support a quick response to unexpected or sudden events.

For the International Space Station (ISS), a more sophisticated trace-gas monitoring system (TGM) is required. The long duration of the mission opens the door to excessive accumulation of off-gassed products, and the ever-changing payloads increase the risk of contamination through leaks. There is also the risk of unanticipated contaminants arising from, for example, uncontrolled microbial action. Early detection, identification and quantification of the release or build-up of harmful trace gases is therefore essential to safeguard the crew's health and safety.

The TGM strategy adhered to as a baseline during the early stages of the Columbus programme was a full on-board air analysis in real time covering all imaginable compounds, both qualitatively and quantitatively. It soon became clear that the equipment needed to achieve this was going to be too big, too heavy and too costly. It was therefore decided to step back and rethink the strategy. Was it really necessary, for example, to monitor all of the 300-plus trace gases on the SMAC list? A review of the results of atmosphere quality measurements from past Shuttle and Spacelab missions supported the

### The FTIR principle

Figure 1 is a schematic of a typical FTIR spectrometer, which consists essentially of an infrared source, collimating and focussing optics, a Michelson interferometer for wavelength selection, a sample gas cell, and an infrared detector. During one measurement cycle, the 'moving mirror' is moved over a few millimetres (about 10), modulating the light from the infrared source. A plot of the intensity measured at the detector as a function of mirror position is the primary interferogram, which is the Fourier transform of the original spectrum of the light source. If a gas is introduced into the gas cell, the plot will contain the characteristic absorption features of the gas, enabling it to be identified.

Mixtures of gases can also be analysed in a similar way, but now the individual absorption features are all superimposed, resulting in very complex absorption spectra. Unravelling these spectra to identify the component gases and deduce their respective concentrations involves complicated data processing and is one of the greatest challenges of the technique.

### Requirements

Based on the results of analyses of the cabin air during several Shuttle and Spacelab missions, the decision was taken to concentrate on the 26 most frequently detected contaminants. These are listed, together with their corresponding 6-hour and 10-day SMAC values, in Table 1. Of these 26 compounds, just five proved particularly problematic for the FTIR and will need to be treated separately in most cases (e.g. for hydrogen and hydrazine) by using dedicated sensors. Detection of the remaining 21 compounds (items 1 – 21 in Table 1) therefore formed the driving requirement for the FTIR trace-gas monitoring system.

A minimum detection threshold was defined for each compound, equal to 10% of the appropriate 10-day SMAC value. In addition, measurement accuracy had to be equal to or better than 10% throughout the concentration range defined by the 10-day and 6-hour SMAC values. All of these measurements must be made taking full account of the existence of carbon dioxide and water vapour as ever-present background gases. The time to be taken for one complete measurement was set at not more than 1 minute.

At this relatively early stage of development, the stringent requirements normally associated with the engineering of flight equipment were not made directly applicable. The ultimate purpose of the development was kept continuously in mind, however, resulting in the

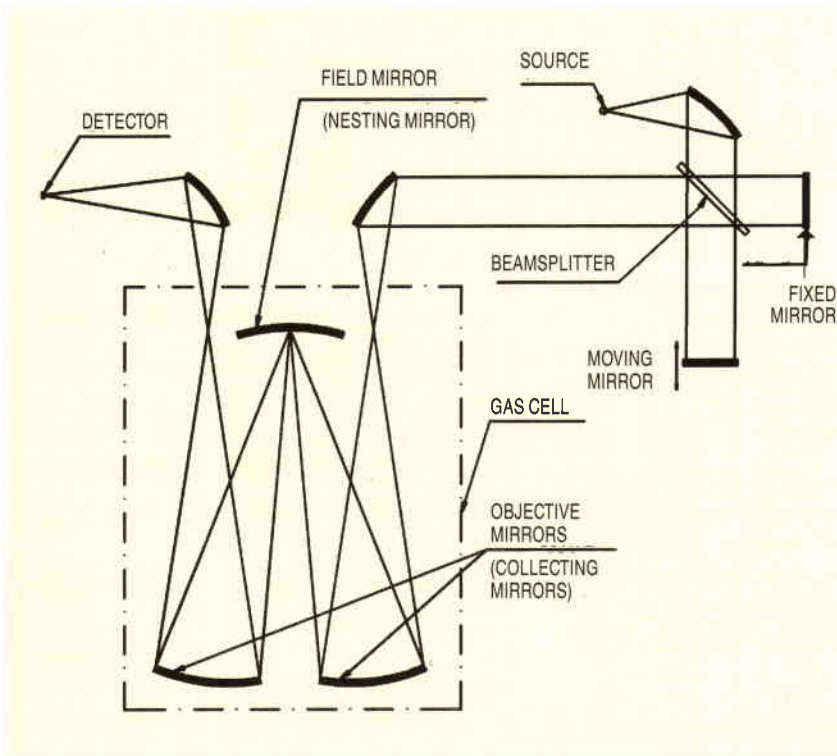

Figure 1. Layout of a typical FTIR system

view that, provided they were properly selected, the number of compounds needing to be monitored could be limited to about 20.

With this now much more manageable set of requirements, a search was made for a technique that had the potential to do the job whilst still being capable of being developed into a viable piece of space instrumentation. The Fourier Transform Infra-Red (FTIR) spectrometer was eventually chosen. The full details of the trade-off supporting this choice are beyond the scope of this article. Basically, however, most of the trace gases to be monitored are either inorganic or volatile organic compounds, the quantitative detection of which is the special province of FTIR spectrometry, a technique that also has high selectivity, adequate sensitivity and the potential to be engineered into a compact and robust instrument.



Table 1. Trace gases to be monitored

No.	Gas	Formula	10-day SMAC		6-hour SMAC	
			ppm	mg/m <sup>3</sup>	ppm	mg/m <sup>3</sup>
1	Acetone	CH <sub>3</sub> -CO-CH <sub>3</sub>	200	475	750	1780
2	Ammonia	NH <sub>3</sub>	25	18	25	18
3	Benzene	C <sub>6</sub> H <sub>6</sub>	2	7	10	30
4	Bromotrifluoromethane (Freon 13B1)	CF <sub>3</sub> Br	100	610	1000	6100
5	2-Butanone	CH <sub>3</sub> -CH <sub>2</sub> -CO-CH <sub>3</sub>	50	140	200	590
6	Carbon monoxide	CO	20	23	50	55
-	Decamethyltetrasiloxane* <sup>1</sup>	Si <sub>4</sub> O <sub>3</sub> [CH <sub>3</sub> ] <sub>10</sub>	15	115	70	480
7	Dichloromethane	CH <sub>2</sub> Cl	25	85	100	350
8	Ethanol	CH <sub>3</sub> -CH <sub>2</sub> OH	240	450	1000	1900
9	Fluorotrichloromethane (Freon/Frigen 11)	CCl <sub>3</sub> F	100	560	1000	5600
10	n-Hexane	CH <sub>3</sub> -[CH <sub>2</sub> ] <sub>4</sub> -CH <sub>3</sub>	12	43	50	180
-	Hydrogen* <sup>3</sup>	H <sub>2</sub>	3000	245	12250	1000
-	Hydrazine* <sup>2</sup>	H <sub>2</sub> N-NH <sub>2</sub>	0.004	0.005	0.015	0.02
11	Methane	CH <sub>4</sub>	5000	3280	5000	3280
12	Methanol	CH <sub>3</sub> OH	50	60	200	260
-	Monomethyl hydrazine* <sup>2</sup>	CH <sub>3</sub> -NH-NH <sub>2</sub>	0.01	0.02	0.03	0.06
13	Nitrogen dioxide* <sup>4</sup>	NO <sub>2</sub>	0.5	0.94	-	-
-	Nitrogen tetroxide* <sup>5</sup>	N <sub>2</sub> O <sub>4</sub>	0.7	1.4	3	6
14	2-Propanol* <sup>6</sup>	CH <sub>3</sub> -CH(OH)-CH <sub>3</sub>	50	120	200	500
15	Toluene	C <sub>6</sub> H <sub>5</sub> -CH <sub>3</sub>	20	75	100	375
16	1,1,1-Trichloroethane	CCl <sub>3</sub> -CH <sub>3</sub>	80	450	350	1900
17	Trichloroethylene	CHCl-CCl <sub>2</sub>	12	65	50	270
18	1,1,2-Trichlorotrifluoroethane (Freon 113)	CCl <sub>2</sub> F-CClF <sub>2</sub>	100	760	1000	7600
19-21	Xylenes* <sup>7</sup>	C <sub>6</sub> H <sub>4</sub> -[CH <sub>3</sub> ] <sub>2</sub>	20	87	100	435

1: not included due to too low a vapour pressure

3: to be detected by separate fuel-cell sensor

5: detected as NO<sub>2</sub>/N<sub>2</sub>O<sub>4</sub> equilibrium

7: three isomers: m-, o-, p-Xylene

2: not detectable within specified ranges

4: only 10-day SMAC available

6: SMAC values of 1-Propanol

selection of a particularly compact and rugged FTIR interferometer and an emphasis on robust software able to cope not only with the analytical task, but also with inherent deficiencies in the FTIR technology, such as baseline drift.

### Accuracy and precision

In quantitative gas analysis, an important issue is the quality of the measured data, i.e. to what extent are the data reliable? High precision (i.e. good repeatability) does not necessarily imply good accuracy.

'Accuracy' is the ultimate quality criterion for any measurement because it determines how close an experimentally-determined value comes to the 'true' value. The difference between the two, i.e. the 'total analytical error', can be split into two contributions, the random error and the systematic error.

'Precision' is an estimate of the effect of random errors. If systematic errors are neglected, the requirement for 10% accuracy is a requirement for 10% precision, or repeatability, of measurement. This can be interpreted (ISO 6879 and ISO/DIS 9169.4) as

the need for a measurement total standard deviation not exceeding 3.6% in the concentration range from 10-day to 6-hour SMAC values.

There are essentially three sources of random error: instrument defects ('hardware errors'), modelling inaccuracies ('software errors'), and calibration and test-gas errors ('calibration errors'). If the 3.6% standard deviation is, admittedly somewhat arbitrarily, split equally between these sources, each can contribute no more than 2.1% (in 'rms' sense). These individual contributions are discussed in a little more detail in the accompanying coloured panel (see next page).

### Instrument design

The FTIR instrument consists of a 0.5 cm<sup>-1</sup>-resolution Michelson interferometer, a multiple-reflection, variable-path-length 'White' gas cell in which the path length has been fixed at 8.94 m (equivalent to 16 passes) and an MCT (mercury-cadmium-telluride) semiconductor detector. The detector runs at a temperature of about 77 K and has its maximum sensitivity at a wavelength of 14 microns. The infrared source is a SiC

## Error Sources

### – Instrument Imperfections:

the 'allowed' 2.1% of the 10-day SMAC must be shared between instrument noise and instrument stability. Thus each can contribute no more than about 1.5% (in 'rms' sense). For example, for a typical organic compound with a 10-day SMAC value of 15 ppm, and assuming a 9-m optical path length, the implied measurement stability at a non-absorbed wavelength (a so-called 100% line) is about  $\pm 0.5\%$  in order to contribute no more than 225 ppb (1.5% of the 10-day SMAC). The above consideration assumes the use of only one spectral point for concentration determination. In fact, however, many points are used and the resulting averaging effect reduces the criticality somewhat. This is most effective in the case of the noise component, due to its relatively high frequency. The much lower frequency associated with instrument instabilities requires that special measures be taken and this is discussed further in the context of 'baseline drift compensation'.

### – Modelling Inaccuracies:

for the analytical software, the standard deviation should be better than 2.1%; model inaccuracies tend to be more systematic than random in character.

### – Calibration and Test-gas Errors:

the uncertainty in composition of calibration and test gases introduced by the mixing processes must not introduce an error contribution exceeding 2.1%.

glowbar working at a temperature of 910 K. The typically-achieved peak-to-peak signal-to-noise ratio (SNR) is about 500, and the stability of the instrument, measured in terms of the stability of the 100% line, is about 3%.

The instrument is shown schematically in Figure 2. Figure 3 is a photograph taken from above the instrument showing, from top to bottom, the interferometer, gas cell (left) and transfer optics (right), and liquid-nitrogen-cooled MCT detector (bottom right).

The flow-chart for a single measurement is illustrated in Figure 4. With the air sample in the gas cell, the primary interferogram data are recorded. After computation of the absorption spectrum via Fast Fourier Transform (FFT) analysis followed by reference-background division and logarithm computation, the concentrations of individual gases are evaluated by Partial Least Squares (PLS) multivariate analysis. The method employs a 'comb function' to systematically eliminate saturated or ambiguous regions of the spectrum from consideration, in order to cope with overlapping gas spectra and the spectral interference from the ever-present water vapour and carbon dioxide.

### Baseline drift compensation

Instrument instabilities are caused mainly by changes in source temperature or by changes in the alignment of the interferometer. They are

manifested mainly via a drift in the 100% transmission line, the so-called 'baseline'. In the prototype instrument, the drift was a few percent over longish time periods and had to be compensated for. Instead of making a baseline correction by pre-processing and explicit fitting of baselines, an implicit baseline-drift compensation was included in the model's construction and calibration process.

### Testing

The test results are summarised in Table 2 and Figures 5(a)–(d). Table 2 shows the accuracy achieved in the form of the standard deviation, and also lists the deduced detection limits calculated on the basis of the standard deviation for a 'zero-concentration' measurement (in accordance with ISO 6879 and ISO/DIS 9169.4).

### Tests with synthetic mixtures

Tests were performed with 100 different synthetic gas mixtures. Table 2 (columns 3 & 4) lists the final results in terms of Standard Error of Prediction (SEP) – essentially, standard deviation – determined at the 10-day SMAC. The results have to be compared with requirements (cf. 'S/W errors': SEP52.1% of 10-day SMAC which is consistent with the required overall precision of 10% of 10-day SMAC). It can be seen that the required standard error criterion is met for all gases. The three most difficult gases, toluene (2.07%), benzene (1.95%) and NO<sub>2</sub> (1.73%), are just within the requirements. Benzene is interfering with carbon dioxide, toluene is interfering with several other gases, and NO<sub>2</sub> is interfering with water. This interference has two effects: it lowers the effective signal-to-noise ratio due to overlapping, leading to larger SEPs, and it generates non-linearity effects due to insufficient resolution.

### Tests with real mixtures

Testing with real gas mixtures was limited to the five compounds plus background gases (water and carbon dioxide) listed in Table 3. These gases are all among those for which real reference spectra were measured, thus ensuring that the calibration was as accurate as possible for these tests.

Fifteen mixtures were made in order to test the system's overall analytical capability. The concentrations of the different gases in each mixture are shown in Table 3. The first four constituents and water were liquid when injected into the gas cell, whilst the methane and carbon dioxide were injected as gases. To minimise the uncertainty in the concentrations of the different gases, a liquid mixture of the

above-mentioned (liquid) constituents was injected, instead of injecting small individual volumes of the pure liquids themselves. The amounts of liquid injected typically had relative standard deviations of less than 1%. The gases, methane and carbon dioxide, were injected with separate gas syringes.

The results of the tests with real gas mixtures are shown in graphical form in Figures 5(a)–(d). The measured concentrations are compared with the reference (known) concentrations for four stable gases in the mixtures: benzene, 2-butanone, trichloroethane, and methane. Methane and water appeared not to be stable, due almost certainly to adsorption in the gas cell, and were disregarded. The solid line in each figure is the ideal line. In all cases, each of the fifteen gas-mixture measurements is actually represented by a cluster of four points, which are almost on top of each other and are the results of two 1-minute and two 5-minute measurements.

In general, there is good agreement between measured (predicted) and reference (known) concentrations. However, how reproducible the measurements are, in statistical terms, is better seen in Table 2. The SEP values in column four (measurements on real gas mixtures) for the compounds flagged with a single asterisk show only the results of instrument noise, baseline drift and some interference from nearby spectral lines, since their concentrations were zero in the gas mixtures concerned.

When the results are compared with the requirements – the SEP for synthetic testing to 2.1%, the SEP for real gas testing to 3.6%, and the detection limit to 10%, all of the 10-day SMAC – all are compliant except those for benzene and NO<sub>2</sub>. From Figure 5b it can be seen that the smooth curve-fitting for benzene exhibits significantly larger deviations than appear among the groups of four measurements at each concentration. This can be explained by a nonlinear interference from carbon dioxide. In the case of NO<sub>2</sub>, the high SEP is explained by interference from water. In both cases, the effect results from deviations from Beer's Law. A dedicated nonlinear-modelling exercise for these two compounds was successful in reducing the SEP for benzene from 3.3% to 2.2%, and that for NO<sub>2</sub> from 6.2 to 3.4%.

In an attempt to improve the performance still further, the effects of increased measurement time and refinements in baseline-drift compensation have been investigated. It was

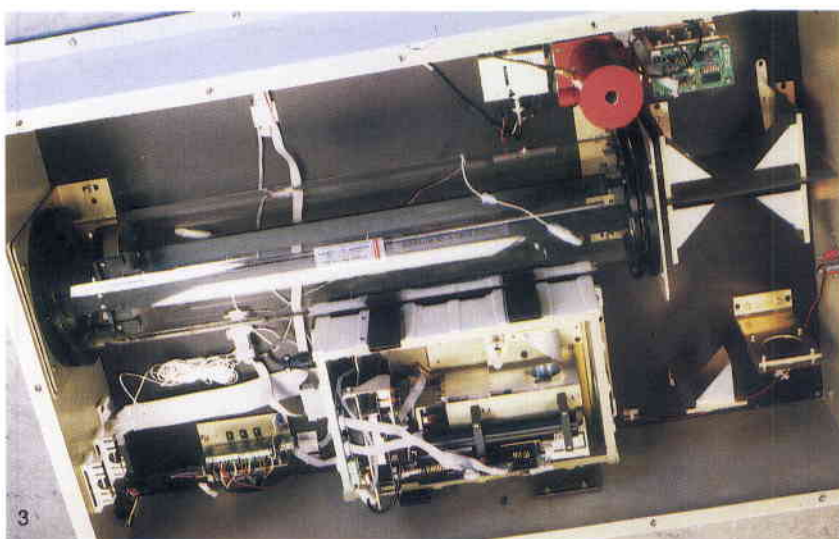
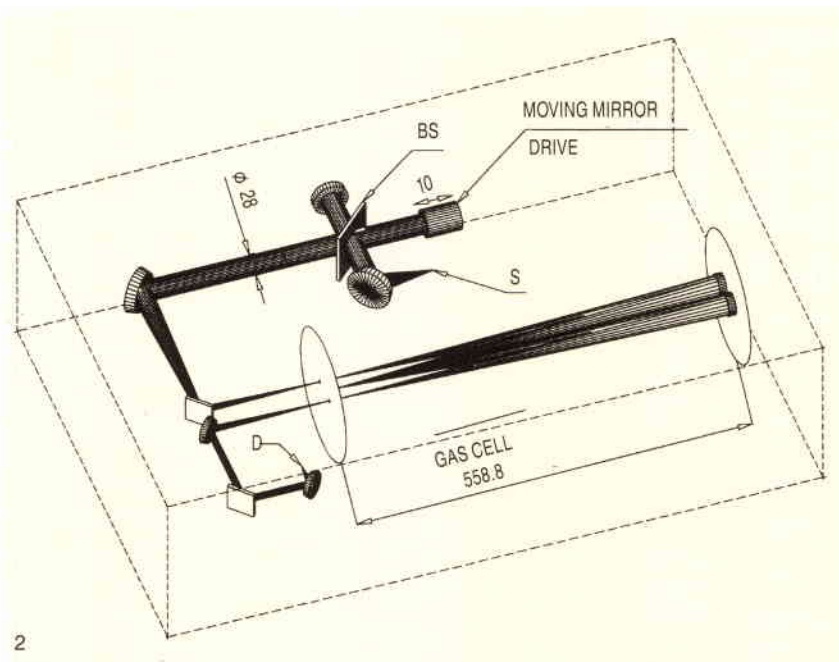

Figure 2. Schematic of the FTIR instrument:

- S = infrared source
- D = detector
- BS = beam splitter

Figure 3. The FTIR prototype

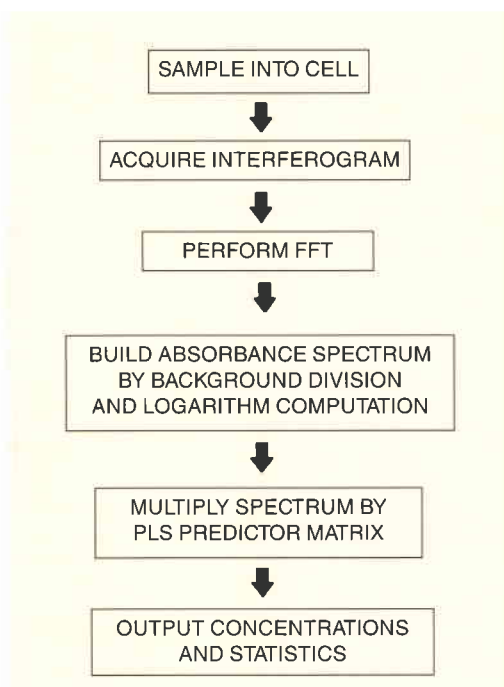

Figure 4. Measurement flow and data treatment

Table 2. Results of model testing with synthetic- and real-gas mixtures (1 min acquisition time)

No.	Gas	Standard Error of Prediction (Synt.)		Standard Error of Prediction (Real)		Detection Limit	
		ppm	% of 10-day SMAC	ppm	% of 10-day SMAC	ppm	Rel. to Req.
1	Acetone*	1.38	0.69	0.99	0.50	2.3	0.12
2	Ammonia*	0.10	0.41	0.13	0.54	0.31	0.12
3	<i>Benzene</i>	0.04	1.95	0.066	3.3	0.15	0.77
4	Freon 1381*	0.17	0.17	0.15	0.15	0.34	0.034
5	<i>2-Butanone</i>	0.44	0.88	0.79	1.6	1.8	0.37
6	CO*	0.01	0.06	0.017	0.085	0.039	0.020
7	Dichloromethane*	0.073	0.29	0.15	0.62	0.36	0.14
8	Ethanol*	0.31	0.13	0.44	0.18	1.0	0.043
9	Freon 11*	0.34	0.34	0.36	0.36	0.83	0.083
10	n-Hexane*	0.06	0.50	0.31	2.6	0.71	0.61
11	<i>Methane</i>	1.50	0.03	8.2	0.16	19	0.038
12	<i>Methanol**</i>	0.06	0.12	8.4	17	-	-
13	Nitrogen dioxide*	0.009	1.73	0.031	6.2	0.072	1.4
14	Isopropanol*	0.50	1.01	0.40	0.80	0.93	0.19
15	Toluene*	0.42	2.07	0.50	2.5	1.2	0.58
16	<i>1,1,1-Trichloroethane</i>	0.06	0.08	0.14	0.17	0.32	0.040
17	Trichloroethylene*	0.03	0.28	0.040	0.33	0.093	0.077
18	Freon 113*	0.15	0.15	0.26	0.26	0.61	0.061
19	m-Xylene*	0.11	0.53	0.079	0.40	0.18	0.092
20	o-Xylene*	0.09	0.47	0.086	0.43	0.20	0.10
21	p-Xylene*	0.05	0.27	0.10	0.51	0.24	0.12
22	<i>Carbon dioxide</i>	40.00	1.00	22	0.56	52	0.13
23	<i>Water vapour**</i>	34.80	0.13	6200	23	-	-

Gases involved in the mixtures are in italics.

\* Estimates for standard error (real), and detection limit based on zero-concentration measurements only.

\*\* Estimates for detection limit are not meaningful because of depletion due to gas-cell adsorption.

Table 3. Concentrations [ppm] of the constituents of the test mixtures according to the injected amounts

Mixture No.	2-Butanone	Methanol	1,1,1 - Trichloroethane	Benzene	Methane	Carbon Dioxide	Water Vapour
1	92.26	42.05	53.11	0.48	511	1014	4998
2	26.70	52.28	8.48	1.49	1217	2534	4998
3	65.42	66.78	13.70	4.21	1012	1517	7997
4	56.48	77.72	19.91	2.49	751	2017	7942
5	56.33	88.64	19.45	0.52	590	1012	5998
6	103.33	92.23	8.43	2.65	529	1512	5998
7	75.98	100.01	28.53	3.88	588	2009	6984
8	28.69	33.97	11.70	5.22	507	2517	6984
9	75.76	76.83	24.81	4.91	907	1007	4998
10	103.91	53.50	15.48	0.97	667	2007	4998
11	48.10	207	59.91	4.20	484	3992	4929
12	59.53	237	41.83	0.27	1001	3396	9996
13	12.47	193	57.33	8.80	643	2997	13419
14	24.18	226	72.02	2.56	821	1498	12050
15	5.96	225	49.95	0.23	1000	484	15062

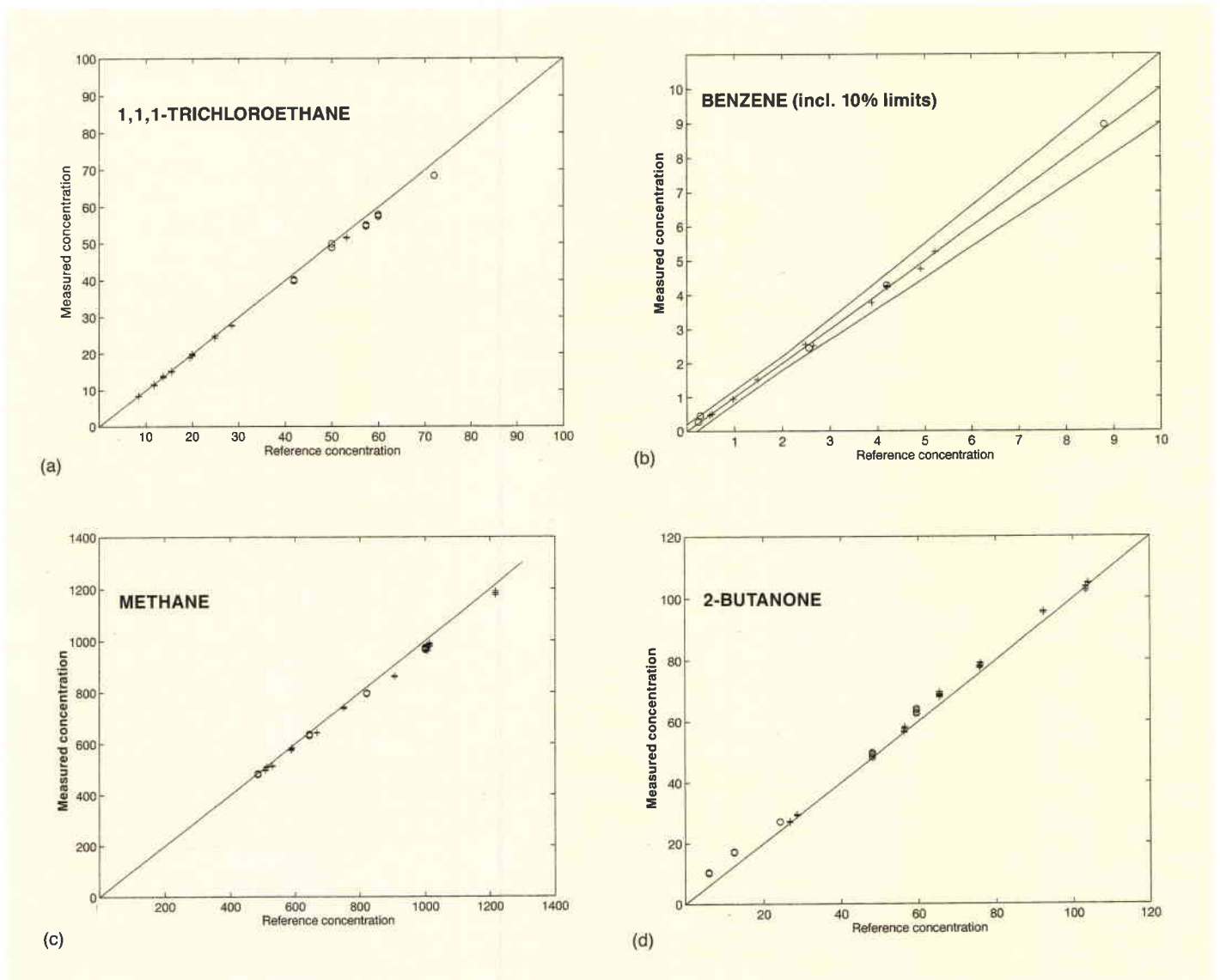

found that increasing the measurement time from 1 to 5 minutes resulted in an insignificant improvement. In the case of baseline-drift compensation, the spectra have been evaluated using background spectra obtained in two different ways. 'Measured background' means that each absorption spectrum has been calculated with a background measured a few minutes prior to measuring the spectrum. 'Common background' means that all the spectra have been calculated with one single background obtained earlier. This corresponds more closely to what will happen in practice in space, where the background will be measured only once per week or once per month. The common background in our case has been generated by taking an average of previously-measured backgrounds.

The test results showed that the baseline drift compensation was successful. In fact, the results showed that the use of 'common background plus baseline-drift compensation' typically produced better results than use of 'measured background'.

### Conclusion

A prototype trace-gas monitor (TGM) based on FTIR technology has been developed to enable the quality of spacecraft cabin air to be monitored on board in near-real-time. The instrument makes extensive use of 'off-the-shelf' hardware and software and has demonstrated its ability to measure, reliably, at concentrations below 10% of 10-day SMAC values and in the presence of water vapour and carbon dioxide, the 21 trace contaminants most frequently found in the cabin air after Shuttle and Spacelab missions.

Further work will focus on refining the hardware and extending the library of detectable compounds.

**Figures 5 a–d. Results of system performance tests (concentration in ppm volume)**

# The ATV Rendezvous Pre-development (ARP) Project

## M. Cislighi

ATV Division, ESA Directorate of Manned Spaceflight and Microgravity, ESTEC, Noordwijk, The Netherlands

## M. Lellouch & J.M. Pairot

Matra Marconi Space, Toulouse, France

### 1. Introduction

ESA's contribution to the International Space Station (ISS) was decided in October 1995 by the ESA Council meeting at Ministerial Level in Toulouse (F). One of the main elements of that contribution is the development of the Automated Transport Vehicle (Fig. 1), an unmanned, Ariane-5-launched vehicle that will perform regular reboost/refuelling and payload supply/removal missions to the ISS.

---

**ESA's Automated Transfer Vehicle (ATV) is being designed to rendezvous and dock fully automatically with the Service Module of the International Space Station (Russian segment). Since 1994, therefore, the Agency has been engaged in the pre-development of automated rendezvous technologies, which are still a novel area of expertise for European space industry. This work, currently being performed within the framework of the ARP (ATV Rendezvous Pre-development) project, will lead into and be finalised within the ATV Development Programme proper.**

**This article provides an overview of the ARP project, the activities of which are split in two main phases focussing respectively on the 'long-range' rendezvous leg, based on relative-GPS techniques, and on the final 'short-range' leg, based on measurements with a laser rendezvous sensor that is also being developed within the ARP. The project involves several ground simulation campaigns, as well as three flight demonstrations being performed in cooperation with NASA.**

**The ARP System activities are under the Prime Contractorship of Matra Marconi Space (F), the ARP Rendezvous Sensor development is the responsibility of DASA Jena Optronics (D), and the ARP GPS Receiver is being procured from Laben (I).**

---

More specifically, the ATV's primary role will include:

- performing rendezvous and docking with the ISS Service Module, using the same port as the Russian Progress vehicle
- remaining attached to the Station for pre-determined periods during which such tasks as the transfer to the Station of pressurised cargo items and propellant for

ISS refuelling, the raising of the ISS's orbit ('reboosting'), and the loading of ISS waste items, will be performed

- de-docking from the ISS to perform a destructive re-entry.

Clearly, therefore, complete mastery of automated rendezvous technologies is an absolute must if the ATV is to be capable of fulfilling these highly demanding mission objectives. Three essential benefits of the Automated Rendezvous Pre-development (ARP) project to the ATV's development proper are therefore:

- minimising the ATV development risks
- convincing the ISS partners of ESA's ability to perform automated rendezvous operations
- contributing to securing the overall ATV/ISS development, verification and validation process.

It will also be possible to reuse the ARP results in other future ESA projects calling for automated rendezvous capabilities.

### The ARP Project

The development, verification and validation of the ATV's automated rendezvous capability will be a progressive process of verification and validation based on the three main stages of the ARP Project (Fig. 2)

- (i) Designing and developing a prototype of the ATV's automated Rendezvous Control (RVC) system, using relative-GPS techniques for the so-called 'long-range' leg of the rendezvous manoeuvre (until approx. 250 m from docking), and a laser Rendezvous Sensor (RVS), also developed within the ARP, for the final 'short-range' leg.
- (ii) Verifying the onboard control functions, the GOAS (Ground Operator Assistant System) functions, and the RACSI (Remote ATV

Control System at ISS) functions in closed loop with the verification simulators.

(iii) Validating the verification simulators by comparison with the results of flight demonstrations and with the results of already validated simulators and simulation models.

The ARP outputs intended to be used directly or indirectly in the ATV's development are:

- the design, development and validation of the prototype RVC System
- the design, development and validation of the Rendezvous Ground Simulator (RVGS)
- the design, development, manufacture and pre-qualification of the RVS (optical laser sensor).

It is crucial to maintain the tightest possible interfacing between the ATV and ARP projects, in order to:

- allow the ARP to take into account as early as possible the evolving ATV requirements and concepts, thereby increasing the likelihood of correct anticipation of the ATV developments proper
- allow the critical ARP results to be fed into the ATV's development as soon as they become available.

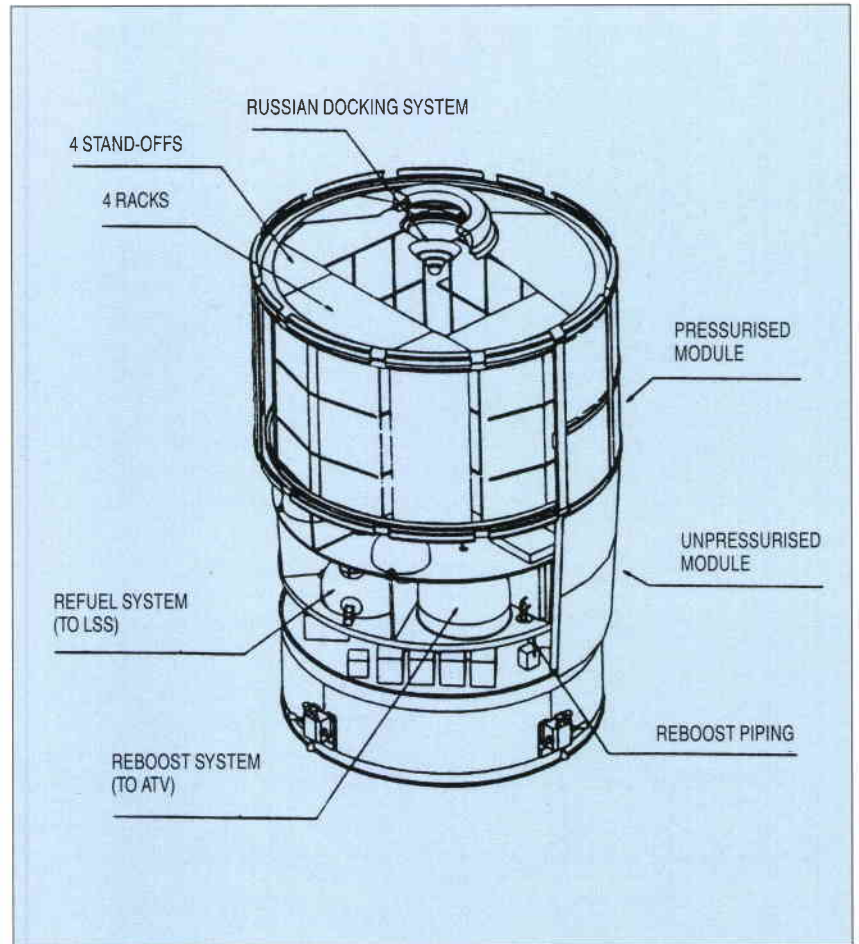

Figure 1. The ATV (Phase-B configuration)

In practice, ATV/ARP coherence is ensured via joint reviews and phased milestones, under the

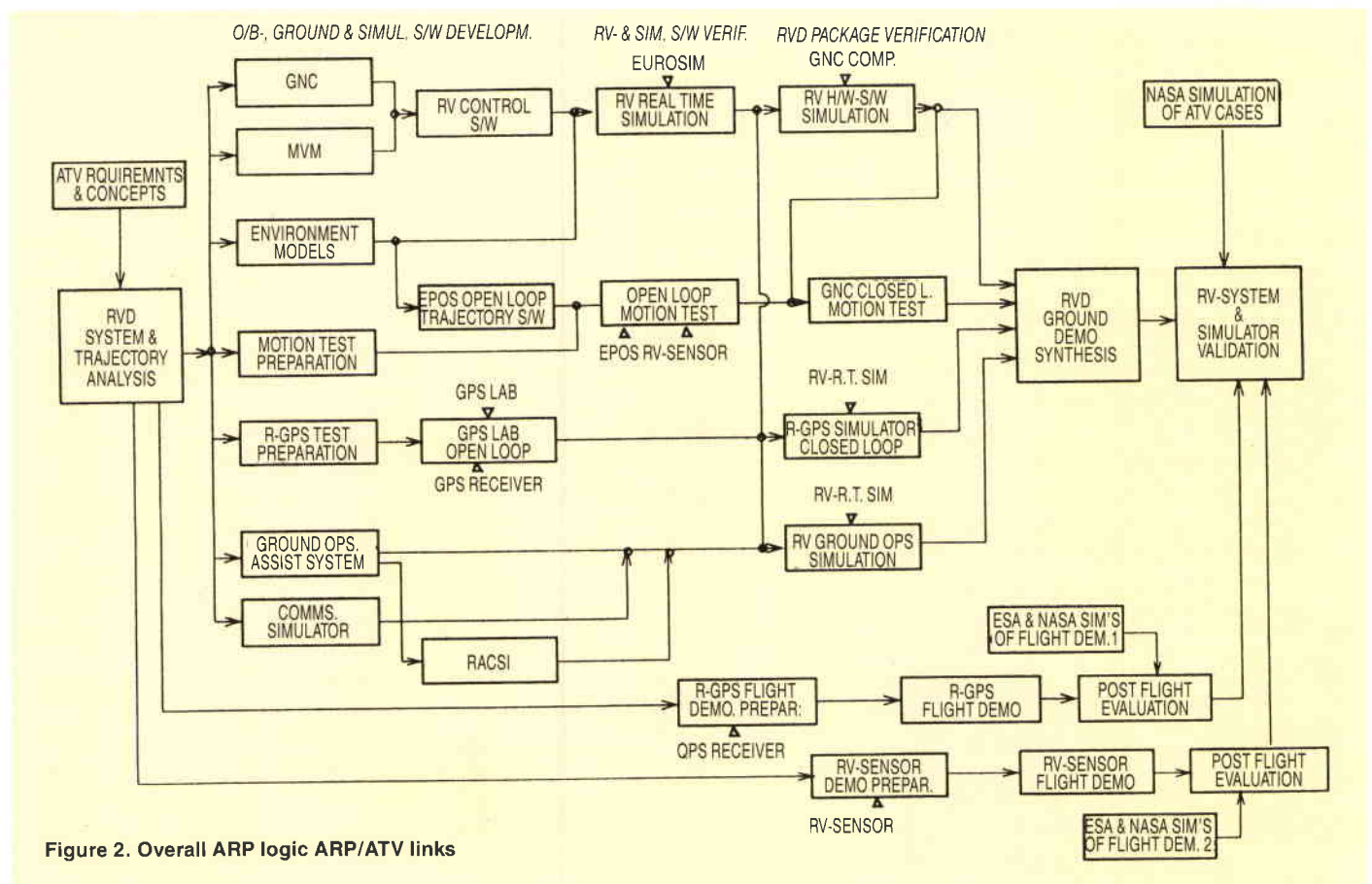

Figure 2. Overall ARP logic ARP/ATV links

close monitoring of the ESA management common to the two projects.

Typical ATV inputs to be used for the ARP include, for example, the mission scenario, the approach strategy, the trajectory design, the operations concept, as well as the overall ATV system-design concepts, including those for propulsion, data management, communications, ground control, etc.

On the other side, typical ARP outputs to be provided to the ATV include, for example, detailed trajectory-analysis results, detailed rendezvous system-analysis results, detailed rendezvous-related algorithms, detailed environment-modelling algorithms for the ATV spacecraft and the space environment, results of closed-loop real-time simulations of the prototype rendezvous control software, etc.

### Implementation

From the implementation standpoint, the ARP is subdivided into three strongly inter-related contracts:

- *The ARP Kernel*, in the charge of Matra Marconi Space (MMS, France), in turn leading a broad consortium of European firms. It covers all the system-level activities relating to the design, development and validation of the automated rendezvous technologies for the ATV, including the ground simulations and orbital flight demonstrations.
- *The ARP Rendezvous Sensor (RVS)*, in the charge of DASA Jena Optronics (DJO, Germany). It covers the development of the laser sensor to be used for the short-range leg of the ATV rendezvous manoeuvre.
- *The ARP GPS*, in the charge of Laben (Italy). It covers the procurement and adaptation of the GPS receiver to be used as a basis for the ARP activities associated with the long-range leg of the ARP rendezvous manoeuvre.

This distribution of responsibilities not only meets ESA's geographical-return constraints, but also ensures the widest possible dissemination of the resulting knowhow within the space industries of the participating ESA Member States.

The three flight demonstrations (discussed below in more detail) are based on flight opportunities offered by NASA as one of the major elements of the overall Inter-Agency ISS Cooperation Agreements. In addition, dedicated agreements have been reached between ESA and the German National Space Agency (DARA) for the utilisation by ARP of the Orfeus-Spas satellite (FD1) and of the

MOMSNAV experiment (FD2 and FD3). Finally the Russian part of FD2 and FD3 has been implemented by means of a commercial agreement with the RSC Energia company. ESA is directly responsible for the technical management of these components of the ARP project, and as a result ESA's role within ARP is not limited to the 'institutional' function of customer, but it is rather that of a 'Super-Prime Contractor'. This adds another element of interest to the ARP project from the management standpoint.

Part 1 of the ARP activities (pre-developments for the 'long-range' rendezvous leg), initiated in mid-1994, will be completed by summer 1997. The first ground simulation campaign within this slice of the project (GPS open-loop) was performed during the summer of 1996. Part 2 of the work (the 'short-range' rendezvous leg) was started in the spring of 1996 and will continue until the first half of 1998.

### The ARP Kernel

The prototype of the ATV RV Control System being elaborated within the ARP Kernel consists of:

- a. the ATV onboard component including:
  - Mission and Vehicle Management (MVM) functions
  - Navigation function (R-GPS and RVS navigation)
  - Guidance function
  - Control function
  - Thruster Management Function (TMF) and also includes the high- and low-level FDIR software.
- b. the ISS onboard component (Remote ATV Control System on ISS, or RACSI) which will allow the Station's crew to monitor and control safety-critical vehicle and trajectory data.
- c. The ground component (Ground Operator Assistant System, or GOAS) including:
  - RV Mission Monitoring Module
  - RV Equipment Monitoring and FDI Module
  - Strategy Evaluation and Planning Module
  - Immediate Intervention Module
  - Supervision and Commanding Modules

plus a Communication Simulator allowing the GOAS to interface with the onboard components of the RVC System.

The resulting RVC System prototype will be capable of real-time running. The ATV onboard part will be implemented on an ATV-like processor, and it will be connected to hardware models of the RV Sensor and of the GPS Receiver.



Then the ARP Kernel activities include the design, development and validation of the RV verification facility (RVGS), to be used first within the ARP itself and then provided to the ATV as a validated framework for further RV verification test campaigns. The RVGS will be based on the simulation environment provided by Eurosim (ESA's real-time simulation software platform), and it will comprise the following elements:

- software models simulating the effects of environment, vehicle dynamics, and sensor/actuator equipment on the ATV RV manoeuvre (see Fig. 3)
- the General Service Software (GSS), emulating the ATV target computer environment, and providing the various interfaces between Eurosim, the RVS, the GPS Receiver and the RVC prototype software
- hardware elements to be connected to Eurosim, such as the emulated ATV computer on which the RVC prototype software will be run.

For system-verification purposes, the RVGS is also used with real hardware in-the-loop (RVS and GPS Receiver), in conjunction with the following additional verification facilities:

- The European Proximity Operation Simulator (EPOS), located at DLR, Oberpfaffenhofen (D). This facility allows the testing of an RV Sensor by reproducing the relative motion between chaser and target vehicles from 25 m until contact, as well as the associated illumination conditions (both features to be validated by ARP).
- The GPS Laboratory, at ESTEC (NL), which

allows one or two GPS Receivers to be operated by reproducing the RF signal that the Receiver would obtain from its antenna(s) when used under the simulated orbital conditions, including the environmental disturbances (subject of ARP validation).

The ARP Kernel design and development tasks will then be completed by a large number of ground simulation campaigns in combination with the three flight demonstrations mentioned earlier.

#### The ARP RVS

For the last portion of the automated rendezvous manoeuvre, from a range of few hundred metres until physical contact between the docking systems of the ATV and the ISS Service Module, a sensor capable of providing the GNC with high-accuracy relative navigation data is needed. Since no RV Sensor with the required characteristics was available, ESA decided to undertake development of this key item within the framework of the ARP.

The ARP RVS is being developed by DASA Jena Optronics, using an earlier technology development by DASA/MBB as a starting point. It works according to the following basic principles:

- a laser beam (905 nm wavelength) is emitted from the RVS installed on the forward section of the ATV
- this beam is reflected by a dedicated target pattern (composed of six retro-reflectors, see Fig. 4) installed near the docking port of the ISS Service Module

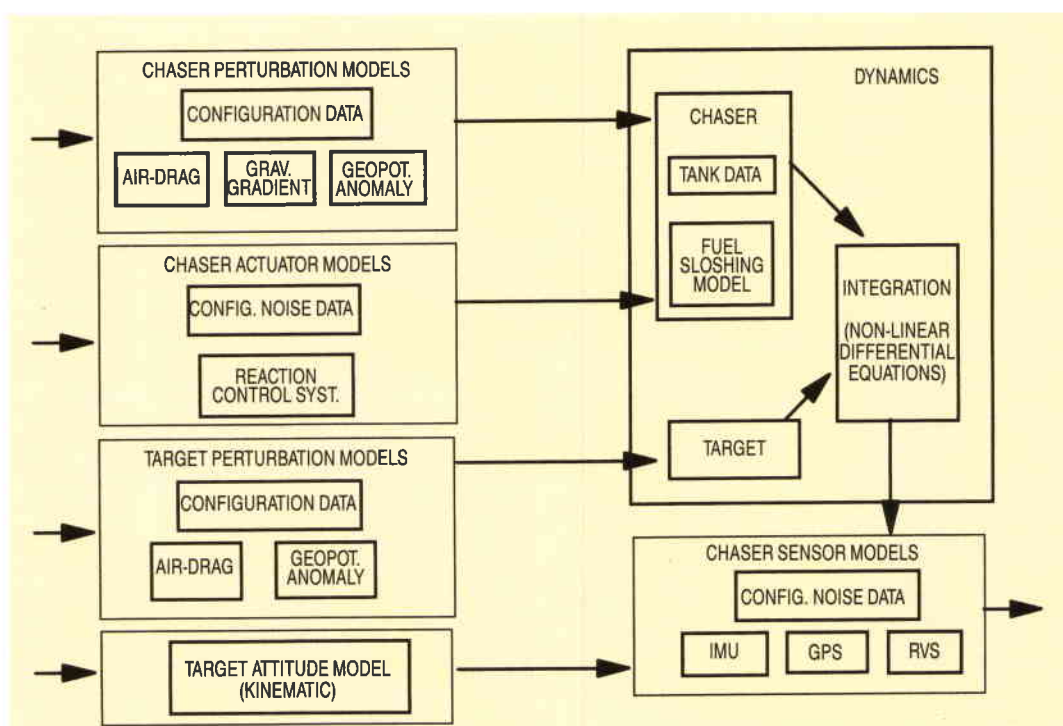

Figure 3. RVGS software model architecture

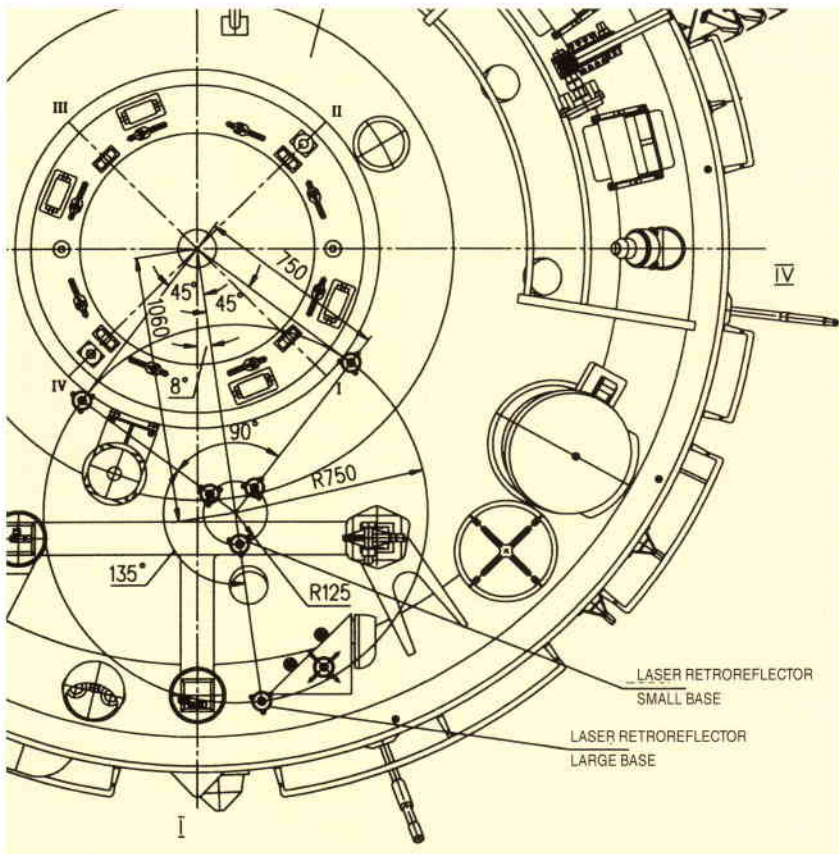

Figure 4. RVS target pattern on the ISS Service Module

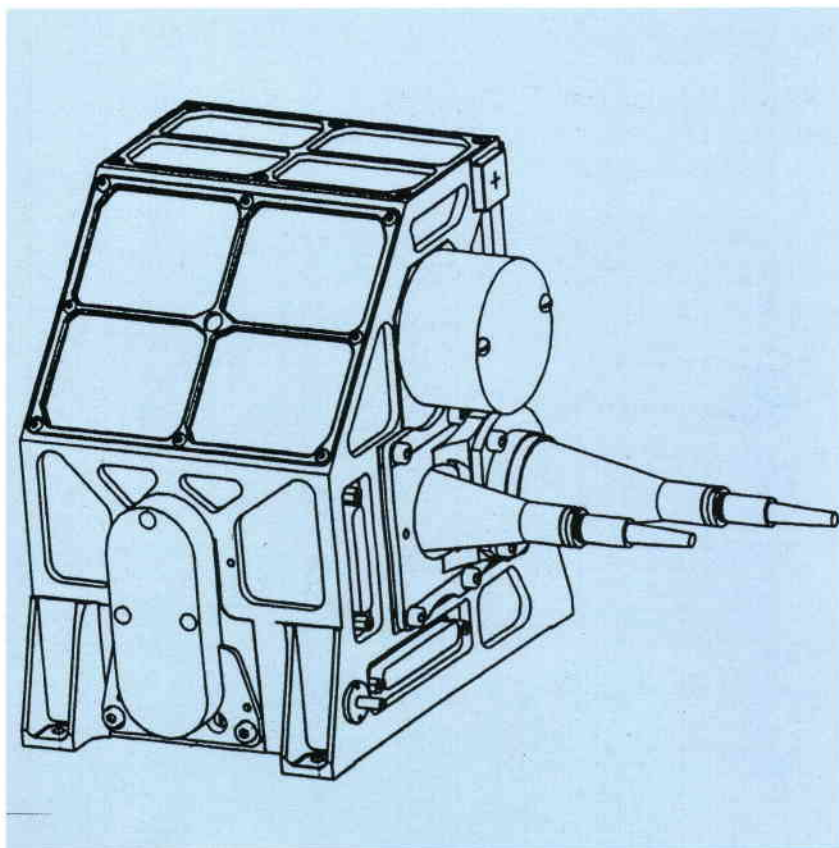

Figure 5. The ARP RV sensor head

- the reflected beam is detected by the RVS on the ATV, and then processed to provide the necessary data to the onboard navigation function (range and range rate, line-of-sight angles and their rates, and for the last 40 m also relative attitude angles and their rates).

The RVS consists physically of two separate units, the Sensor Head (sketched in Fig. 5) and an Electronics Unit. Two models of the ARP RVS will be delivered: a development model for the ground simulations and a protoflight model for the flight demonstrations.

Because of its working principle, RVS performance could be sensitive to parasitic illumination effects as well as the relative motions of the two vehicles. Given that the safety of both the chaser vehicle and the target vehicle and its crew is critically dependent on the RVS working correctly throughout the approach, its validation represents a major contribution to the validation of the ATV's complete automated RV System. Two flight demonstrations and several ground simulations in a realistic environment, in both open- and closed-loop modes, are therefore planned, all of which will make use of real RVS hardware.

#### The ARP GPS

Relative navigation using GPS receivers has not yet been applied operationally in any space project, although several features of the 'long-range' leg of the ATV RV System rely heavily on the expected performance of this method of navigation.

One major unknown is the multi-path effect, but synchronisation-error and selective-availability effects are also not yet well-mastered. The ARP objective of securing the specification on the Relative-GPS navigation performances is therefore of primary importance for validating the overall automated RV System design for the ATV. Its validation also will be pursued within ARP by performing three flight demonstrations and several ground simulations, in both open- and closed-loop modes, making use of real GPS hardware.

ESA is procuring the two ARP GPS Receivers (one flight model and one development model for the ground tests) from Laben (I). The unit selected is derived directly from the Tensor Receiver, jointly developed by Laben and Loral (USA) for a commercial application (56 satellites of the Globalstar constellation). It is a continuous-tracking, nine-channel system composed of two Receiver Processing Units (redundant RPUs), up to four patch antennas (for attitude determination – not needed for

ARP), and up to four pre-amplifiers (in a stack). In particular, each RPU weighs 1.8 kg and comprises an RF section, a digital section (based on a C-MOS ASIC for signal processing and a RAD-6000 micro-processor), and a DC power-supply section. The external data interface is via RS 422.

The ARP GPS software has been modified to allow direct output of the so-called 'raw data' (pseudo-range, carrier cycle count, pseudo-range rate), which are then processed by the R-GPS navigation algorithms predeveloped by the ARP Kernel. The overall architecture of the ARP GPS is shown schematically in Figure 6.

### Automated RV validation (ARP)

The ultimate objective of ARP is to validate a number of items which will then represent the basis for the automated rendezvous of the ATV, where validation means 'proving that a given item behaves as expected when exercised in the real environment'. Such complex validation objectives can be subdivided into three main groups:

#### Validation of RV concepts, specific equipment and related models

Proper validation of R-GPS and RVS-based navigation technical elements is essential, due to their novelty. They include RVS performance validation, RVS navigation-concept validation as well as RVS equipment (and measurement environment) modelling for the 'short-range' RV leg, and GPS receive performance validation, R-GPS navigation-concept validation as well as GPS measurement-system modelling for the 'long-range' RV leg.

The ARP Flight Demonstrations will be the essential contributors to these validation steps.

### Validation of other models

This group includes the validation of software models necessary for representing the 'external world' for the RVC system. They consist of:

- equipment (gyros, Earth and Sun Sensors, thrusters)
- environment and perturbations (air drag, geopotential field, fuel sloshing, plume impingement)
- dynamics (position and attitude motion integration)
- spacecraft models (geometry, mass/inertia, target kinematic characteristics)

for which a validation process needs to be established, including comparison and parallel activities with NASA (see later) and, when possible, use of Flight Demonstration outputs. Full validation of the items in this group will only be possible within the ATV framework.

### Validation of tools and facilities

This group includes the part of the RVGS residing in the Eurosim facility, as well as the other system verification facilities (i.e. Eurosim connected respectively to EPOS and GPS Lab.). The ARP validation activities are expected to demonstrate their suitability for later use by the ATV. In particular, they should provide the necessary that the software models included in this group do indeed provide a correct representation of the RVC external environment when they are connected together.

### Cooperation with NASA

Substantial benefits in the model-validation domain are expected from cooperative activities with NASA. In practice, it is envisaged to perform: (a) documentation exchange and comparison analysis at 'equation level', and (b)

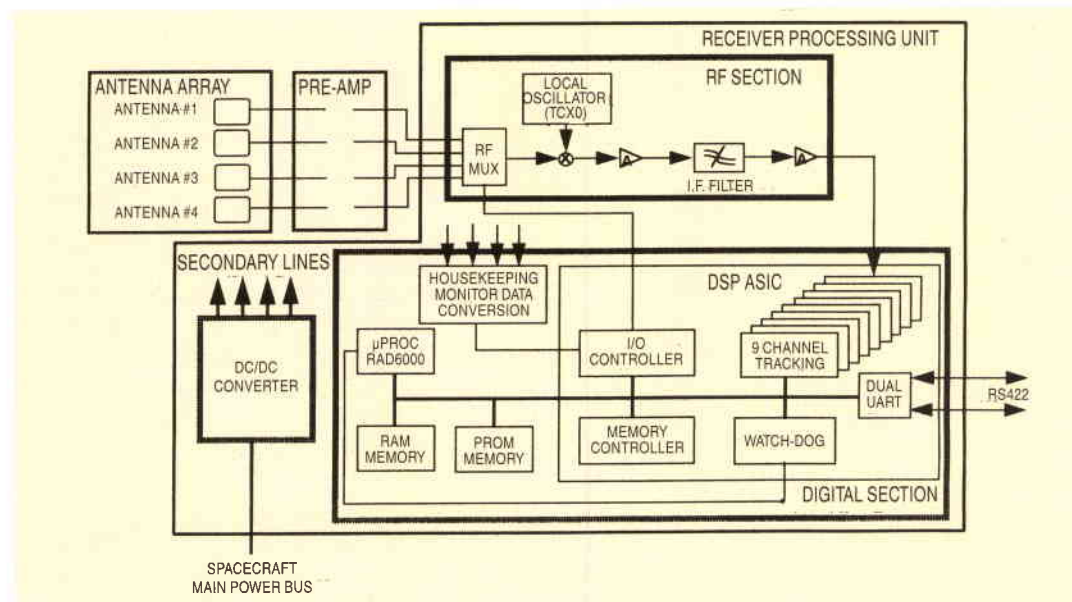
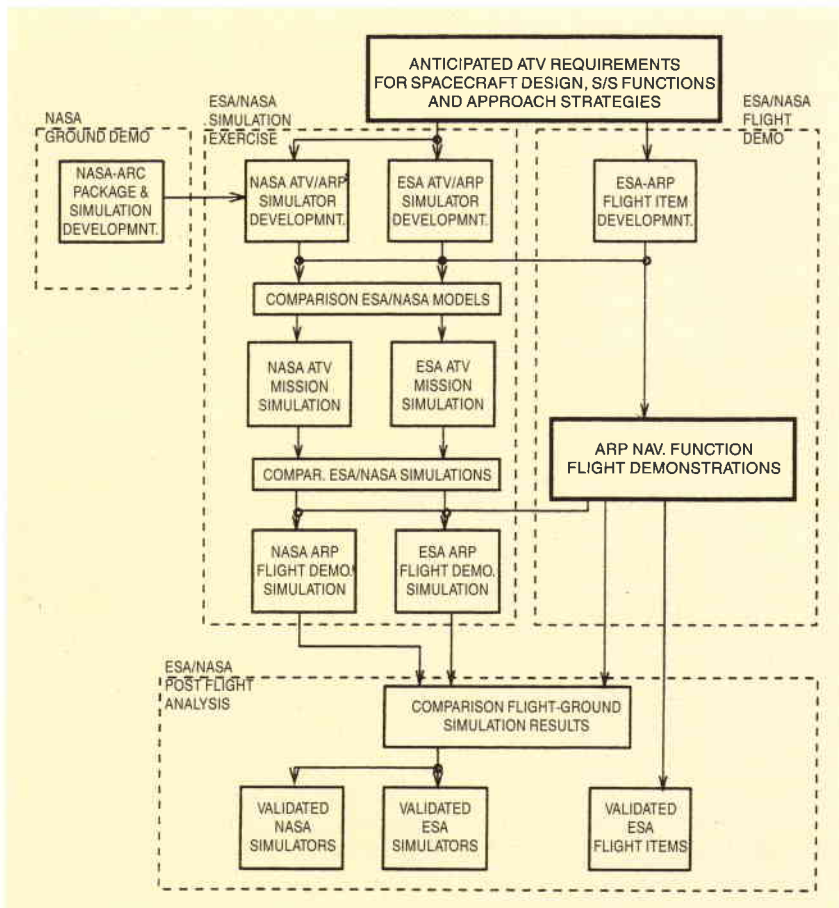

Figure 6. ARP GPS architecture

parallel open-loop simulation runs of respective model algorithms on similar input files. The basic objective of this work is to establish confidence in, or at least assess, the representativeness of the physical behaviours being modelled. The global logic of such activities is represented in Figure 7.

The only ground simulation campaign so far completed is the GPS Open-Loop Test



**Figure 7. ESA/NASA model-validation logic**

Campaign, conducted by the ARP Kernel Prime Contractor (MMS) at the ESTEC GPS Laboratory, with the support of the ARP GPS Contractor (Laben). The specific objectives of this campaign were:

- identification of GPS Receiver functional behaviour and characteristics
- assessment of the GPS Software Model's representativeness, and
- preliminary validation of the R-GPS navigation algorithms with actual data.

Four series of tests representing various mission profiles – no movement, circular orbit, ATV orbit and ISS orbit for a V-bar approach – have been run, with the following preliminary results:

1. A thorough identification of GPS Receiver functional behaviour and characteristics has been performed, allowing complete

understanding of the GPS/Navigation interface mechanism. In addition, recommendations for improving some GPS Receiver outputs have been issued.

2. The GPS Software Model has been thoroughly validated either via direct comparison with the GPS Receiver or via the R-GPS algorithms. Some minor differences have been detected, but they do not affect the navigation performance results obtained so far.
3. Good R-GPS navigation algorithm behaviour was observed. In particular, the filter was capable of rejecting most of the unexpected GPS Receiver outputs without having a significant effect on the R-GPS navigation performance. Preliminary results in this respect indicate that the relative orbital state-vector estimation performance is in the order of 2 m in position and 0.01 m/s in velocity (three-sigma values).

### Flight demonstrations

#### Flight Demonstration 1

ARP Flight Demonstration 1 (Fig. 8), a Relative-GPS experiment, was performed during a Space Shuttle flight (STS-80) between 19 November and 4 December 1996. The NASA vehicle deployed DARA's Orfeus-Spas satellite, which carried the ARP GPS Receiver. A second GPS Receiver, supplied by NASA, was mounted on the Shuttle. The latter also carried a NASA-supplied optical sensor to track a retro-reflector mounted on Orfeus-Spas, in order to acquire 'true' data in parallel with the R-GPS measurements.

The experiment was performed during both the deployment and retrieval of Orfeus-Spas by the Shuttle. During these periods of about 45 min and 8 h, respectively, the two spacecraft were oriented so as to allow simultaneous zenith-pointing of the antennas of both GPS Receivers. The GPS measurements (raw data) gathered during the experiment were recorded for offline post-processing, which is about to commence at the time of writing.

In addition, data output from the GPS System satellites (Navstar) during the flight demonstration were recorded by ground-based stations equipped with GPS receivers (task coordinated by ESOC), to get the support of differential-GPS techniques for the determination of Best Estimated Absolute Trajectory (BEAT) and Best Estimated Relative Trajectory (BERT).

#### Flight Demonstrations 2 and 3

Flight Demonstration 2 (FD2) consists of a Relative-GPS and an optical Rendezvous Sensor experiment, to be performed during

Shuttle flight STS-84, scheduled for launch on 15 May 1997. During this mission, the Shuttle will rendezvous and dock with the Russian station Mir. The ARP GPS Receiver will be installed on the Shuttle, while the second set of GPS Receiver measurements will be delivered by DARA's MOMSNAV experiment already installed in Mir's Priroda module. The ARP RVS will also be installed on Shuttle; its target pattern will consist of three retro-reflectors already mounted on the Mir Docking Module. Similar to FD1, 'true' data will be available from the NASA TCS aboard the Shuttle.

This experiment will also be performed during both the Shuttle's approach to and departure from Mir. The GPS and RVS measurements gathered will again be stored onboard for later post-processing (Fig. 9).

ARP Flight Demonstration 3 (FD3) will be a reflight of FD2 on Shuttle flight STS-86, scheduled for launch on 18 September 1997. It will represent the ideal opportunity to refine and improve the learning obtained from FD2, to fine-tune the experiment if required, and to correct for any unforeseen occurrences during the earlier flight.

From the R-GPS validation standpoint, FD2 and FD3 will represent a step forward with respect to FD1 because they will not take place in the near-ideal, unobstructed Shuttle/Orfeus-Spas environment, but in a scenario much more representative of the real ATV/ISS rendezvous, thereby generating more valuable information with respect to multi-path effects, shadowing, etc.

**Conclusion**

The ESA Automated Rendezvous Pre-development (ARP) project is designed to help European Industry master the automated rendezvous and docking technologies that are crucial to the success of the ATV missions to the International Space Station. It will generate important products to be used in the ATV's final development, including the prototype Rendezvous Control System, the Rendezvous Ground Simulator and the Rendezvous Sensor, and will validate them by means of three flight demonstrations and several ground simulation campaigns.

In addition to its direct exploitation of these ARP products, the ATV project will also benefit from the specialised knowhow accumulated by the various industrial teams throughout Europe involved in the ARP.

The planned Protoflight Mission to conclude the ATV development and verification process

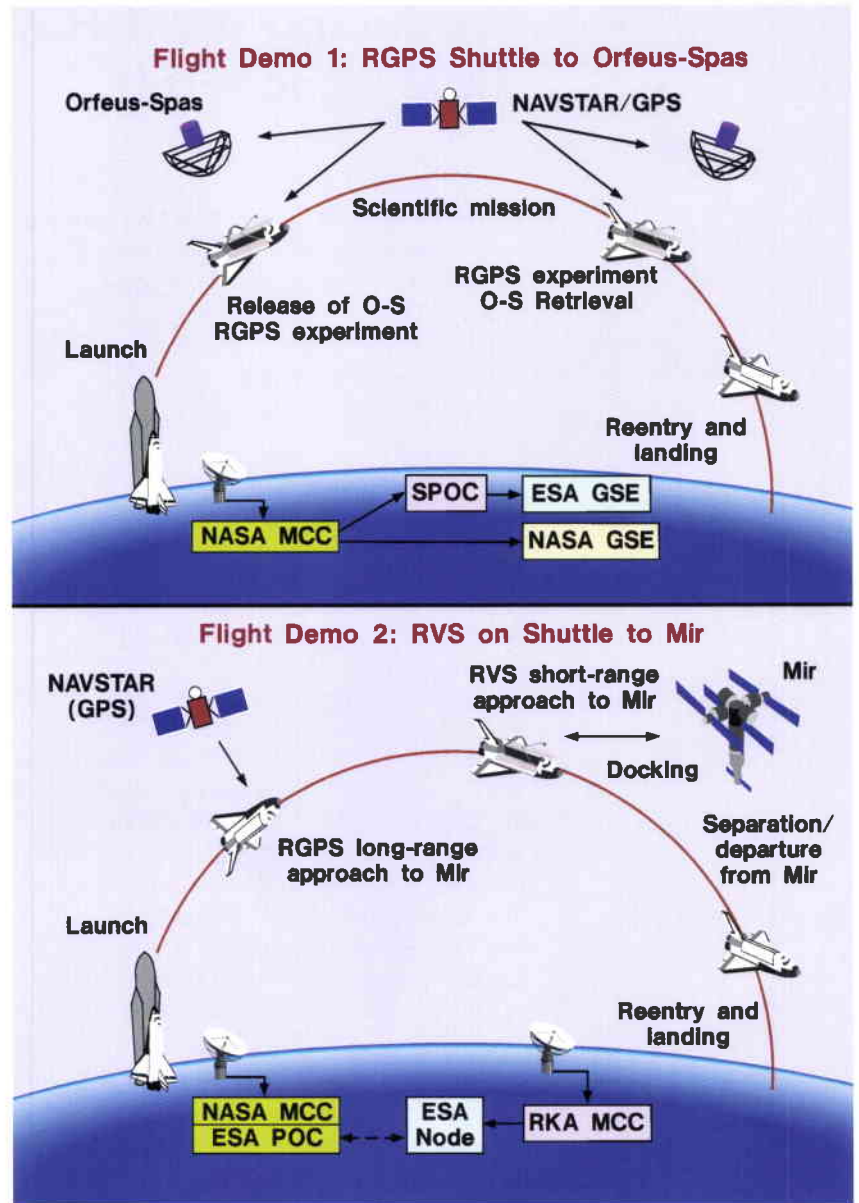

Figure 8. Overview of Flight Demonstration 1

Figure 9. Overview of Flight Demonstration 2

will serve as the final demonstration of the ATV's ability to perform automated rendezvous and docking with the ISS Service Module.

**Acknowledgements**

The authors would like to acknowledge contributions from colleagues involved in the ARP activities, in particular U. Thomas, W. Fehse and D. Paris (ESA), G. Limouzin and D. Thomas (Matra Marconi Space), K.H. Kolk and B. Möbius (DJO), and G. Adami (Laben).

# Producing the X-Ray Mirrors for ESA's XMM Spacecraft

**D. de Chambure, R. Lainé, K. van Katwijk, J. van Casteren & P. Glaude**

XMM Project Team, ESA Scientific Projects Department,  
ESTEC, Noordwijk, The Netherlands

## Introduction

The X-ray Multi-Mirror Mission (XMM) is the second 'Cornerstone' project of ESA's Horizon 2000 Long-Term Science Programme. This spaceborne observatory, due for launch in August 1999 by an Ariane-5 vehicle, has been designed as a high-throughput X-ray spectroscopy mission covering a broad energy range (0.1 – 10 keV). The payload will consist primarily of three telescopes, developed under direct ESA contract by a consortium of European firms (led by Media Lario, Bosisio Parini, Como, Italy), each with specific technical expertise in telescope manufacture. This approach of direct management by ESA was implemented in order to maintain the greatest possible flexibility in seeking solutions to the very considerable technical challenges inherent in the XMM mission.

---

**The XMM satellite project has passed an important milestone with the Mirror Module's successful qualification review being held at ESTEC last October. This is therefore an opportune moment to present the developmental status of this challenging programme, this being the first time that such a large series of high-quality optics has had to be produced: more than 250 X-ray-quality mirrors with a total surface area of 200 m<sup>2</sup> and a surface micro-roughness of better than 0.5 nm.**

---

The optics for each telescope (hereafter referred to as a Mirror Module, or MM) are made of 58 nested Wolter-1 grazing-incidence mirrors, chosen to maximise the effective collecting area within the allocated volume. This highly nested design calls for the manufacture of a large number of X-ray-quality mirror shells. In the early 1990s, therefore, a parallel development programme was conducted using two potentially interesting technologies: CFRP epoxy replication and nickel electro-forming. In 1993, based on the X-ray testing of several individual mirrors, nickel electro-forming technology was selected for the production of XMM's mirrors. Despite its lightness, the CFRP technology showed micro-roughness drawbacks, leading to unstable X-ray performance in vacuum.

Early in 1995, two MM demonstration models, each consisting of several X-ray-quality nickel mirror shells (ranging from the smallest to the largest) integrated onto a representative support structure, were built to validate the manufacturing and integration aspects of XMM mirror development. The test results obtained (a Half-Energy-Width resolution of better than 10 arcsec at 1.5 and 8 keV) confirmed that the nickel mirror technology was indeed able to fulfil the technical requirements of the XMM telescopes.

At that point, however, the production yield ratio of high-quality mirrors was insufficient for manufacturing the 253 shells (total of 200 m<sup>2</sup> of optical surface) needed for the MM qualification- and flight-model production phases. A special programme was therefore initiated early in 1995 in order to deepen our understanding of the manufacturing processes and hence the yield ratio of the mirror-shell production process. By February 1996, this programme had led to the manufacture and on-time delivery of the MM qualification model and, after optical and environmental testing, the MM was pronounced qualified in October 1996.

## The Mirror-Module Development Programme

The overall industrial organisation for the MM development programme is shown in Figure 1. The ESA XMM Project Team, located at ESTEC, is responsible for the management of the MM's development, design, manufacture and testing. It is advised in this task by the XMM Telescope Advisory Group, led by Dr. B. Aschenbach from MPE-Garching (D) who was a key member of the Rosat project.

The project schedule for MM manufacture and testing (Fig. 2) shows their early delivery compared with the spacecraft itself, which is necessary for the timely testing and calibration of the scientific instruments, namely the European Photon Imaging Camera (EPIC) and the Reflection Grating Spectrometer (RGS).

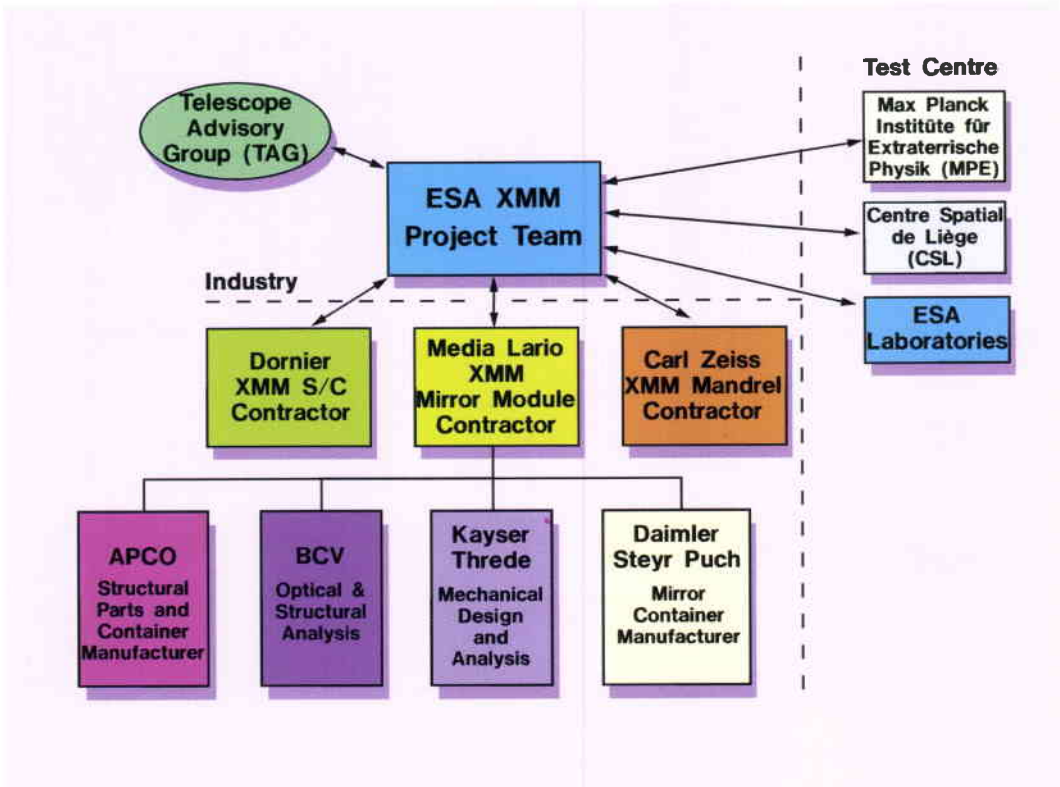

Figure 1. The XMM industrial organisation

The overall XMM development plan called for eight Mirror Module models:

- A Qualification Model (QM). This is equivalent to the Flight Model in that it has 58 mirrors, but only 21 are of X-ray quality. The QM was delivered in March 1996.
- Three Structural/Thermal Models (STMs), which are almost identical to the Flight Models in having 58 mirrors, but not of X-ray quality, used for environmental and alignment verification at spacecraft level. The STMs were delivered between

September and December 1996.

- Three Flight Models (FMs), plus one flight-spares. Two of these FMs have already been delivered.

**The XMM Mirror-Module's design**

The three Mirror Modules (Fig. 3), representing the heart of the XMM payload, are a major technological challenge, each consisting of 58 nested mirror shells bonded onto a spider (spoked-wheel) support structure. These grazing-incidence telescopes (Wolter-1 type) are designed to operate in the X-ray energy range 0.1 – 10 keV, with a focal length of 7.5 m

Figure 2. The baseline development schedule for the Mirror Modules

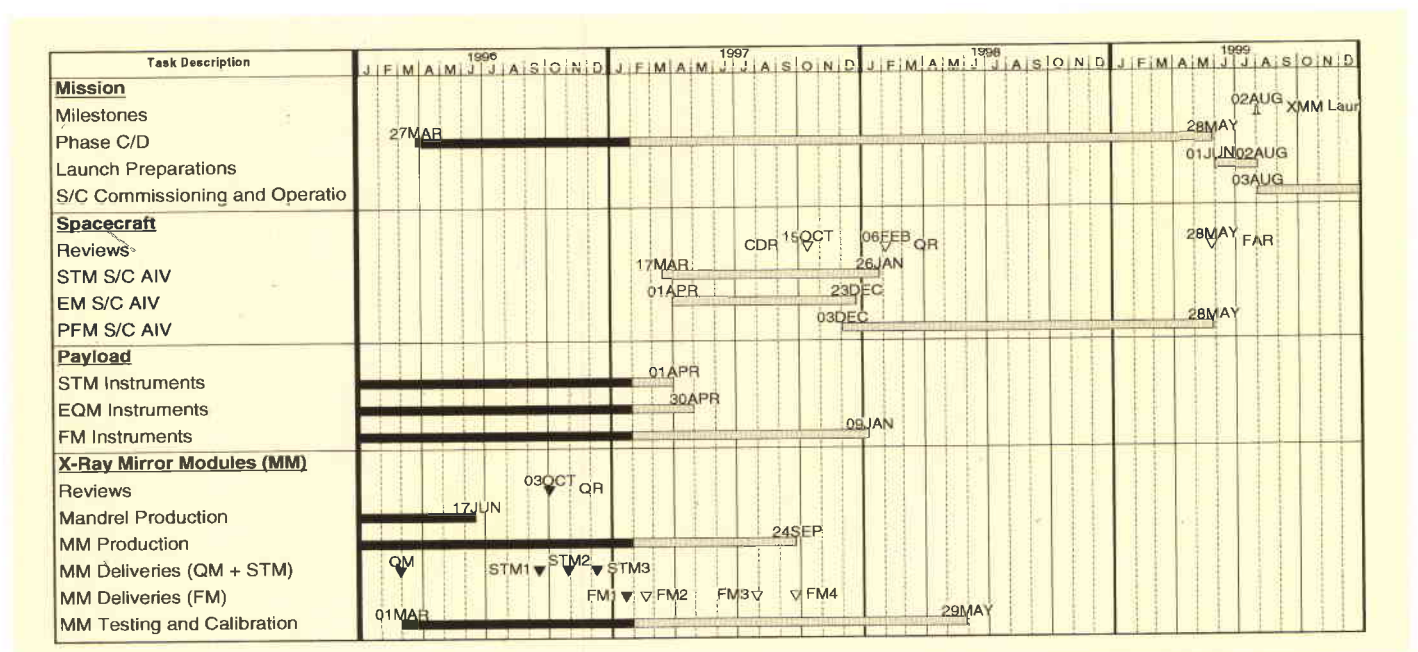

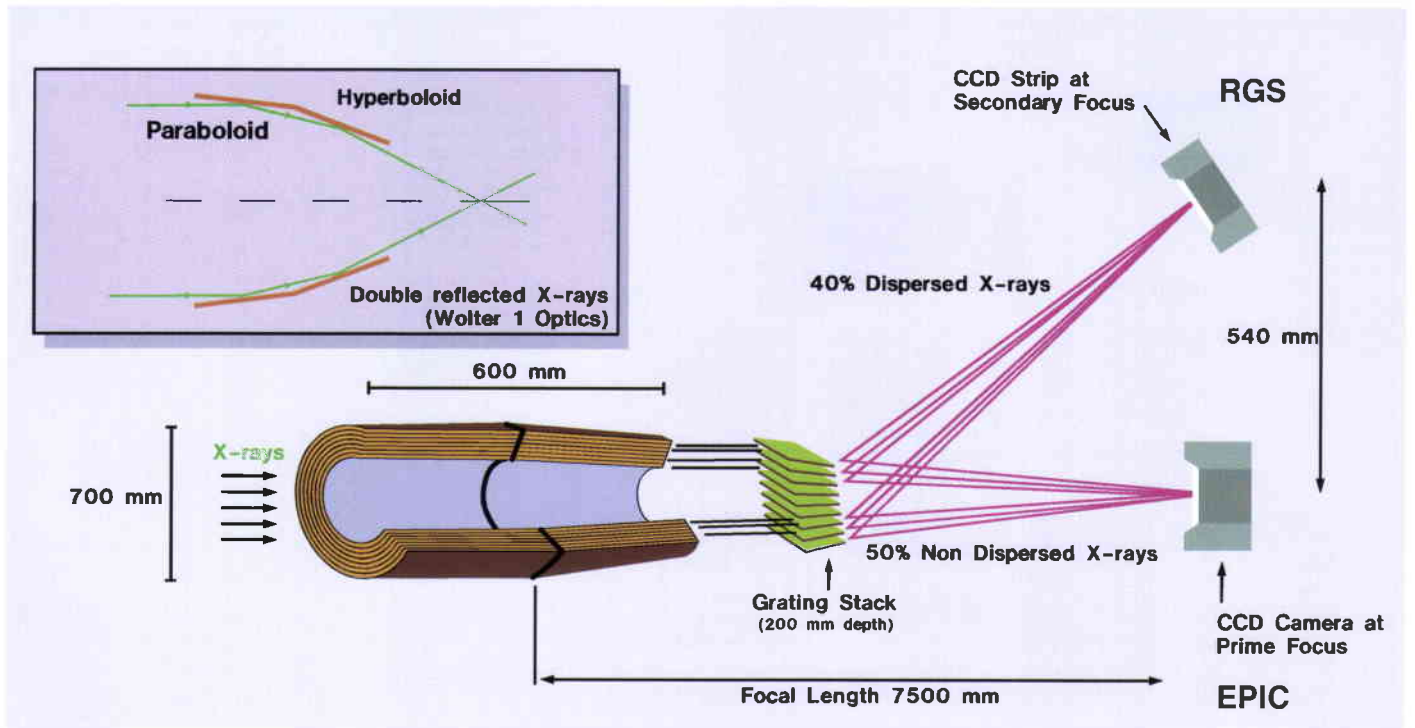

**Figure 3. Optical design of the XMM Mirror Module**

and with resolutions (Half Energy Width) of 20 and 30 arcsec at 1.5 and 8 keV, respectively. The average grazing angle of the X-rays ranges from 20 arcmin for the smallest mirror to 40 arcmin for the largest.

Each mirror is a thin monolithic nickel shell which is shaped to a paraboloid surface in front and an hyperboloid surface at the rear. Incoming X-rays are reflected at grazing angles first from the paraboloid and then from the hyperboloid before converging to the focus.

The 58 mirror shells, with diameters of between 306 and 700 mm and a height of 600 mm, are mounted in a confocal and coaxial configuration. The thicknesses of the mirror shells range from 0.47 to 1.07 mm, in linear proportion to their diameters. The masses of the smallest and largest shells are 2.35 and 12.30 kg, respectively. The reflective surfaces

of the shells are coated with a 250 nm layer of high-purity gold.

The 58 mirror shells are glued at their entrance plane to the 16 spokes of a spider (spoked wheel) which is made from Inconel (Fig. 4). This material was chosen because its thermal-expansion coefficient is close to that of the electrolytic nickel used for the mirrors themselves (confirmed by tests in ESTEC's Mechanical Systems Laboratory). The spider is connected to the XMM spacecraft platform via an aluminium Mirror Interface Structure (MIS, Fig. 4), which consists of a double conical surface reinforced by stiffeners, and an interface ring.

To minimise mechanical deformation of the mirrors and therefore optical degradation during final assembly, the flatness of the mounting interface between the spider and the MIS (a surface with an inner diameter of 740 mm and an outer diameter of 770 mm) needs to be better than 5 microns. The MIS serves the following functions:

- supporting a grating assembly, with a mass of 60 kg, on the back side (on two of the three Mirror Modules)
- attaching an 'electron deflector' right behind the mirrors to divert the soft X-rays that will otherwise will be seen as stray light in the detector
- providing attachment for the optical baffle and the X-ray baffle at its entrance, and for the thermal baffle at its exit, and last but not least
- interfacing with the XMM spacecraft platform.

*Table 1. Main characteristics of the XMM Mirror Module*

Focal length	7500 mm
Resolution Half Energy Width	16 arcsec (0,1–10 keV)
Full Width Half Max,	8 arcsec (0,1–10 keV)
Effective area	1475 cm <sup>2</sup> at 1,5 keV 580 cm <sup>2</sup> at 8 keV
Outermost mirror diameter	700 mm
Innermost mirror diameter	300 mm
Mirror length	600 mm
Minimum packing distance	1 mm
Number of mirrors	58
Mirror Module mass	425 kg



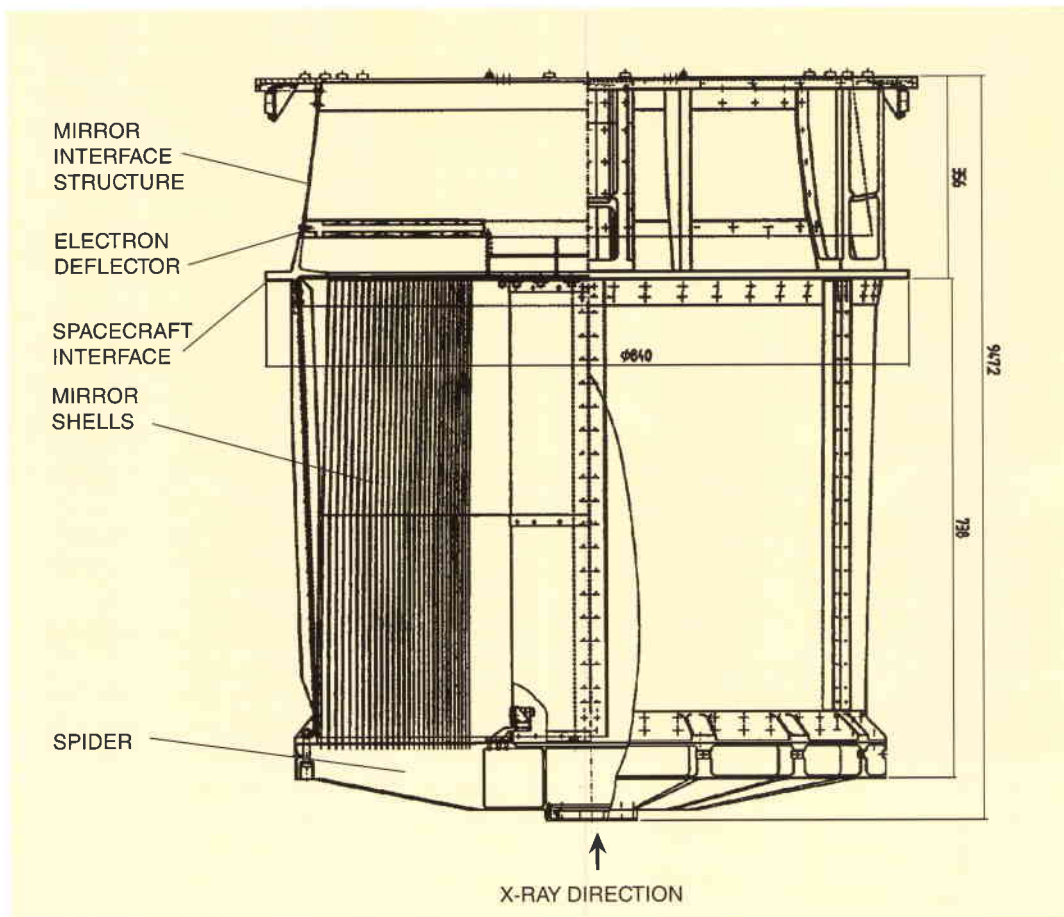

Figure 4. Mechanical design of the XMM Mirror Module

Heaters and thermistors, mounted on the spokes and the outer ring of the spider, provide the thermal control needed to maintain the Mirror Module at  $20 \pm 2^\circ\text{C}$  with transverse and radial gradients not exceeding  $2^\circ\text{C}$ .

The production of the spiders, which are machined from solid blocks of Inconel by wire electro-erosion (Fig. 5), and the aluminium-alloy MIS is contracted to APCO (CH). Given the size of the MIS components and the high accuracy required, and due to the rivetted/glued structure, heat treatment has to be introduced just before the final machining in order to eliminate residual stresses.

#### Manufacture and integration of the mirrors

Mirror-shell manufacture is based on a replication process, which transfers a gold layer deposited on the highly-polished master mandrel to the electrolytic nickel shell, which is electro-formed on the gold layer. The process is fairly conventional but is complicated here by the tight tolerances required and the inherent flexibility of the elements.

The production of the necessary 58 master mandrels has been contracted to Carl Zeiss (D). They are double-conical aluminium blocks coated with Kanigen nickel and then lapped to the exact shape needed, and finally super-polished in several cycles (Fig. 6) to a surface roughness of better than 4 angstrom.

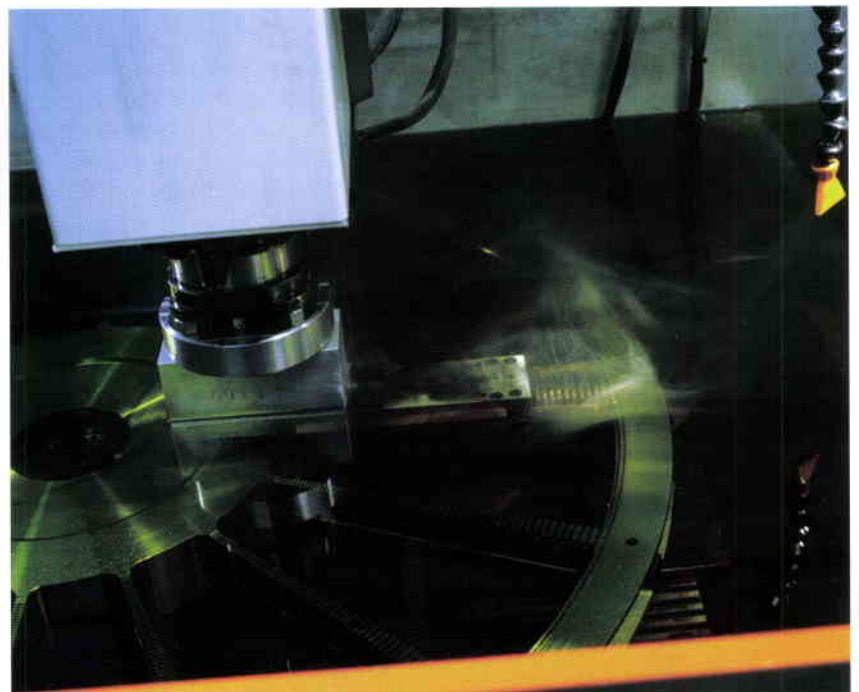

Figure 5. Electro-erosion of the spider

The lapping and polishing cycle typically takes about 10 to 12 weeks. The Kanigen nickel (8–10% phosphor content), deposited by electroless plating, has been selected for its hardness (necessary for good polishing), high adhesion to the aluminium, and low porosity.

The most critical steps in the manufacturing process remain the production of the mirror



**Figure 6. Mandrel super-polishing in progress**

shells (Fig. 7) and their integration onto the spider, both of which are performed at Media Lario (I).

The mirror-shell production is divided into nine main steps:

- after verification of its surface roughness, the mandrel is thoroughly cleaned
- a reflective gold layer (thickness 0.25 microns) is evaporated under vacuum onto the mandrel (deposition from a single source on a rotating mandrel by Joule-effect heating)
- the gold-plated mandrel is prepared for

**Figure 7. The mirror manufacturing and integration process**

- electro-forming, involving the mounting of 'extension plugs' and Viton rings at both of its ends and installation in a support frame that holds it during electro-forming
- the gold-plated mandrel is coated with nickel in an electro-forming bath (nickel sulphamate) with a deposition rate of about 10 micron/h and at a temperature of 50°C
- immediately after the electro-forming process, the inner side of the mandrel is cooled to a temperature of 10°C with liquid nitrogen
- the mirror (nickel) and the mandrel (aluminium) are separated by the difference in thermal expansions of the materials and by the difference in adhesion of the gold layer between the Kanigen nickel of the mandrel and the electrolytic nickel of the mirror (i.e. the gold layer follows the nickel mirror)
- once separated, the mirror is carefully removed with a highly accurate guidance system
- small holes are drilled near the edge of the hyperboloid segment of the mirror for the attachment of a suspension system
- the optical quality of each mirror shell is assessed by geometrical and by micro-roughness measurements.

The mirror-shell integration is performed in a Vertical Optical Bench (VOB), working from the smallest to the largest, with visible light (632 nm), in the following steps:

- each mirror shell is tilted at one end by vertical forces using an actively controlled suspension system

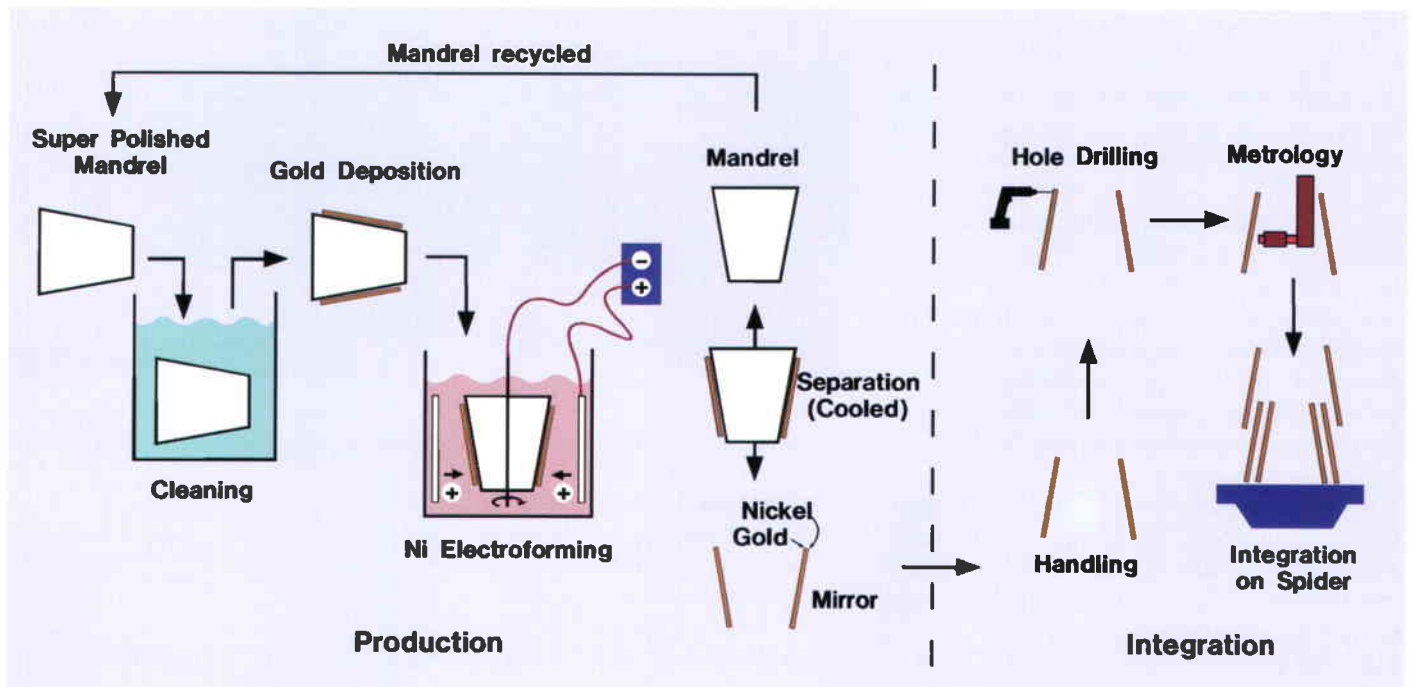



**Figure 8. Mirror Module integration in progress, with 30 (left) and all 58 (right) mirrors in place.**

- the mirror is then laterally and vertically adjusted in the corresponding grooves of the spokes of the spider
- the mirror is bonded in two steps onto the spider using epoxy glue
- the optical performances of the glued mirror are verified and compared with those in free-standing conditions.

The total production time for one mirror, from the cleaning of the mandrel to its integration, including all verifications, is about 12 days. After the integration of all 58 mirrors (Fig. 8), and before the MM's shipment in an ultra-clean transport container to the testing facilities, integration is completed by the mounting of the MIS on the spider, the wiring of the electrical harness, and the adjustment of the alignment optics. To maintain the necessary high reflectivity, the particulate and molecular cleanlinesses of the mirrors have to be maintained (at 300 ppm and  $2 \times 10^{-7}$  g/cm<sup>2</sup>, resp.) until the end of the mission lifetime.

The mirror activities at Media Lario occupy an area of more than 3000 m<sup>2</sup> and employ about 45 persons. The metrology and integration activities are performed in temperature-controlled class-1000/100 clean rooms, which are about 10 m by 10 m and 6 m high. Six electro-forming baths (Fig. 9), two Vertical Optical Benches, two ultrasonic cleaning lines and two vacuum gold-deposition facilities have had to be built and operated simultaneously to maintain the required production rate.

### Mirror technology development

Early in 1993, one of the first strategic decisions taken was to enforce a Total Quality Management system compliant with ISO 9000 standards in order to progress the nickel technology from an 'art' to an industrial production process, with the help of an external

quality-control firm (Bureau Veritas). Each step in the manufacturing flow was therefore systematically and critically reviewed and every major parameter identified and monitored. Thereafter, all manufacturing procedures were validated and configured to ensure good repeatability, reliability and traceability of results. In parallel, the personnel were specially trained and safety precautions were introduced to further stabilise the processes.

To help achieve these goals, metrology equipment and software prediction tools were developed for measuring the geometry (roundness and axial profiles) and the surface quality (roughness) of the mirror shells and for characterising their X-ray optical performances. Also, several specialised items of equipment were developed to monitor the surface quality of the mandrels, including:

- a high-precision 3-D machine (Carl Zeiss UPMC 1200) equipped with an optical sensor system with an absolute accuracy of better than 1 micron
- interference contrast microscopes (Promap

**Figure 9. The electro-forming baths**



512) on special mounts to allow easy access to the insides of the optical elements, with an amplitude accuracy of better than 0.1 nm.

- a polarimetric interferometer (Zeiss Nomarski) with a spatial resolution of better than 1 micron.

Experience showed that the geometry and surface quality of the master (i.e. the mandrel) can be transferred at least ten times to the electrolytic nickel shell without major degradation occurring. This means that theoretically mirror shells with an optical resolution of 5–6 arcsec (HEW) can be made, corresponding to the mandrel quality. In practice, however, this is thwarted by the relatively high adhesion coefficient between the gold layer of the mirror and the Kanigen nickel of the mandrel, and by the mechanical deformations of the electrolytic nickel layer of the shells. In other words, the mirror is a very flimsy shell and its overall shape is strongly affected by the way in which it is supported.

Most of the problems encountered during mirror development were associated with the gold plating, the nickel electro-forming, and the release, handling and integration of the mirror shells.

#### Gold plating

Some problems were encountered in getting the gold layer to separate from the Kanigen nickel of the mandrel. These were overcome by modifying the design of the gold-plating chamber and by improving the gold-plating procedure itself.

#### Nickel electro-forming

Some analyses and a dedicated metrology test campaign revealed that the mandrel was deformed at its edges during the mounting of the electro-forming tools (Fig. 10).

The observed 'trumpet' deformations could result in a loss in optical resolution (HEW) of about 10–20 arcsec. This required a redesign of the electro-forming bath and the associated tools, including deleting the conical mounting of the central shaft and replacing it by flat fixations at both ends of the mandrels, and changing the fixing-bolt position in order to reduce to a minimum the bending moment deforming the mandrel.

Cross-sectional cuts of several mirrors also showed that their thicknesses increased axially towards the edges by up to 20% of the nominal value. Similarly, the circumferential distributions at the edges showed deformations of up to 5%, despite the rotation of the mandrel in the nickel

electro-forming bath. With the help of modelling tools developed by ESTEC's Mathematics and Software Division, part of the bath geometry was modelled and the electrical field and current density were computed. As a result of the ensuing modifications to the design of the electro-forming tools, the excessive edge thickness was reduced to 5–10% and the variation in circumferential thickness was reduced to less than 0.5%.

#### Mirror-shell internal stress

Axial-profile measurements performed on the mirrors with the 3-D measuring machine indicated some very local deformations of 10–20 microns amplitude (propagating on 10% of the mirror surface) that were almost identical at both edges of the mirrors. After some investigations, these were traced to internal stresses in the mirror shells, leading to internal moments that show as radial displacements at the free edges.

Considerable effort was therefore devoted to monitoring and controlling these stresses using 'bent-strip' test samples and chemical analysis



Figure 10. A gold-plated mandrel ready for electro-forming

(liquid chromatography and atomic emission spectrometry) of the nickel electro-forming bath. These data, combined with axial profile measurements on the mirrors, allowed the internal stress to be satisfactorily controlled through a careful balancing of:

- the ease of release of the mirror (too low an internal stress risks nickel solution infiltration between the mirror and the mandrel, while too high a stress leads to a difficult release and mirror deformation)
- the stability of the bath (i.e. chemical

composition)

- the deposition rate for the mirrors (linked to current density and hence internal stress).

### Mirror-shell release

This is definitely one of the most critical operations of the whole manufacturing process. The problems of distortions at the mirror edges due to excessive axial forces, and of adhesion between the mirror and the mandrel were encountered at the outset. This led to the complete redesign of the release stand, including the environmental control and the highly accurate guidance system to lift the mirror from the mandrel. The manufacturing procedure itself was also reworked with improved monitoring of several key parameters, and the final mirror-release step was also refined (Fig. 11). As a result of these efforts, final mirror quality was substantially improved.

### Mirror-shell integration

Testing on various mirror shells both at Media Lario and in ESTEC's Metrology Laboratory showed that the best way to obtain an optimum and repeatable mirror shape was to suspend a mirror shell at its exit plane (opposite to the integration side) using torsion-free wire. Given the design of the spider with 16 spokes, it was decided to suspend the mirror using 16 equally spaced hooks, placed in small holes drilled at the hyperboloid edge (exit plane) of the mirror and located in the shadow of the spokes of the spider to avoid optical-beam vignetting during subsequent mirror integration on the Vertical Optical Bench (VOB). The specially developed, actively controlled suspension system consists of 16 independent adjustable 'hanging devices' mounted symmetrically on a support ring.

As shown in Figure 13, this system allows the correction of the mirror shell's shape, and thus the optimisation of its optical performance, by changing the axial load distribution on each of the 16 'hanging devices'.

In most cases, equal load distribution to within an accuracy of 2% is sufficient for the production of an optimum mirror shell.

In parallel, given the recurrent earlier problems (glue spills, poor wetting on spider and mirror surface, mirror displacement during injection), a series of tests were performed to investigate the injection technique, bonding strength and curing properties of the glue used in integrating the mirrors with the spider. These tests led to the following three-stage bonding procedure:

- cleaning of the surfaces to be glued



Figure 11. Mirror shell during release

- pre-glueing to fix the mirror's position
- final glueing (Fig. 12) using a dosimeter to permanently bond the mirror in the grooves of the spider.

### Mirror-shell production quality

The excellent results of this whole production-improvement programme are represented in the plots of mirror-shell optical performance versus development time presented in Figure 14. They show a production yield ratio of better than 80% after just a few months, which was the original goal. Also worthy of note is the fact that the performances of the large and small mirrors are almost identical despite the greater flexibility of the large ones. The second plot shows that the integration procedure (bonding) does not introduce any optical degradation.

Figure 12. Mirror shell in the process of final glueing



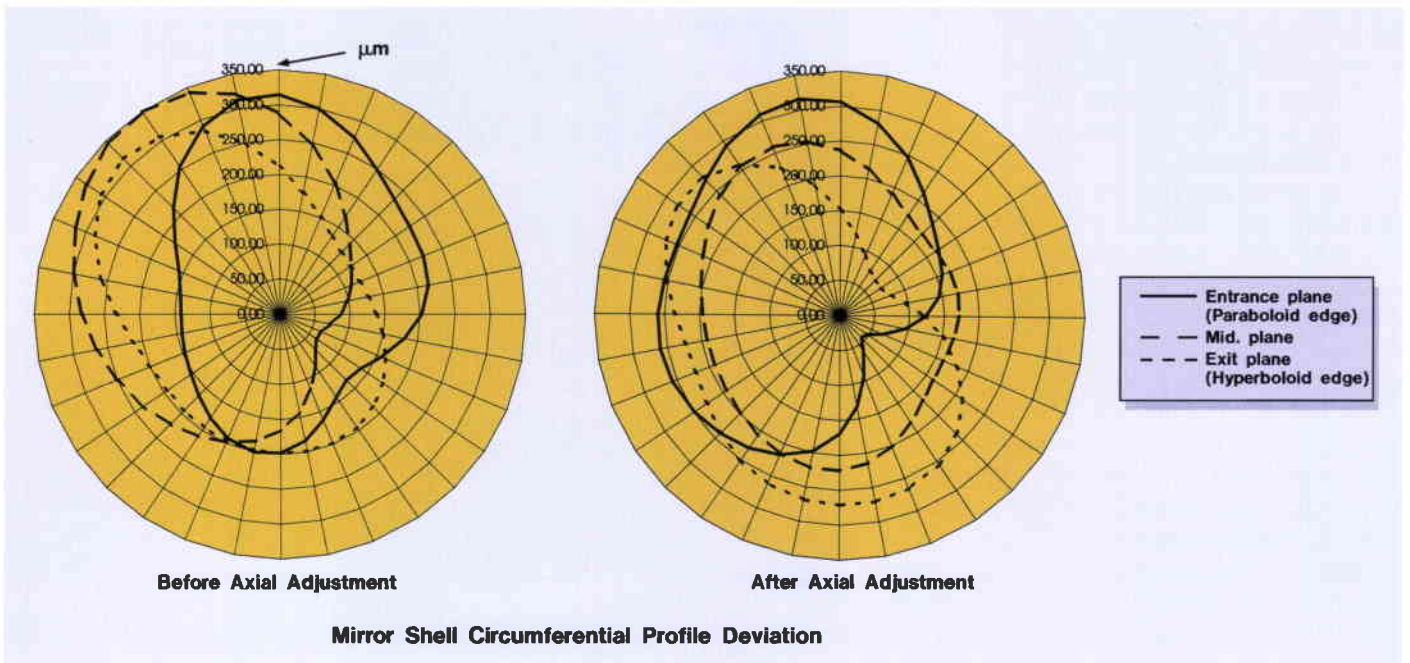

Figure 13. Mirror-shell shape correction through axial force distribution adjustment

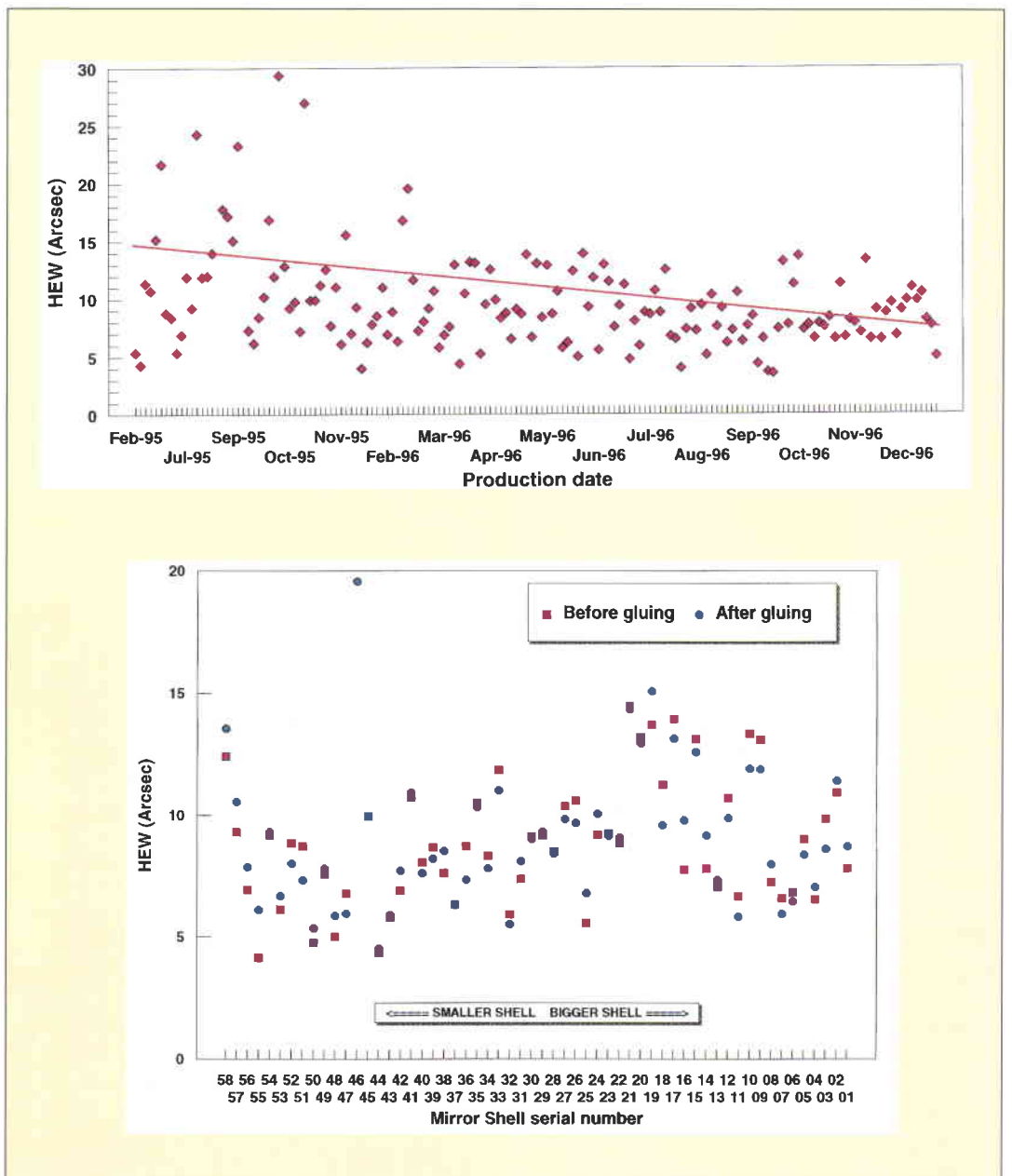

Figure 14. Mirror-shell production quality

### Optical and environmental testing of the Mirror Module

After its delivery to ESA, the qualification model of the XMM Mirror Module, containing 21 X-ray-quality mirrors and 37 dummy mass-representative mirrors, was optically, mechanically and thermally tested between March and September last year at two test centres in Europe: the Max-Planck Institute's (MPE) X-ray facility (Panter) at Neuried in Germany, and the Centre Spatial de Liège (CSL) in Belgium (Fig. 15).

The qualification programme included:

- X-ray optical tests at MPE
- UV optical and X-ray reflectivity testing followed by vibration tests at CSL
- UV optical and X-ray-reflectivity testing followed by thermal-vacuum tests at CSL
- UV optical and X-ray-reflectivity tests at CSL (including thermo-optical and stray-light tests)
- X-ray optical tests at MPE.

Their purpose was to demonstrate that the Mirror Module was meeting its performance requirements under simulated environmental conditions at least as severe as those to be expected during the service lifetime of the XMM spacecraft.

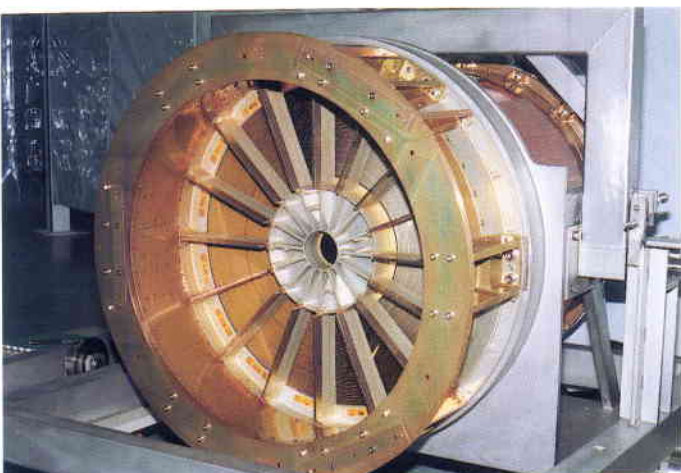
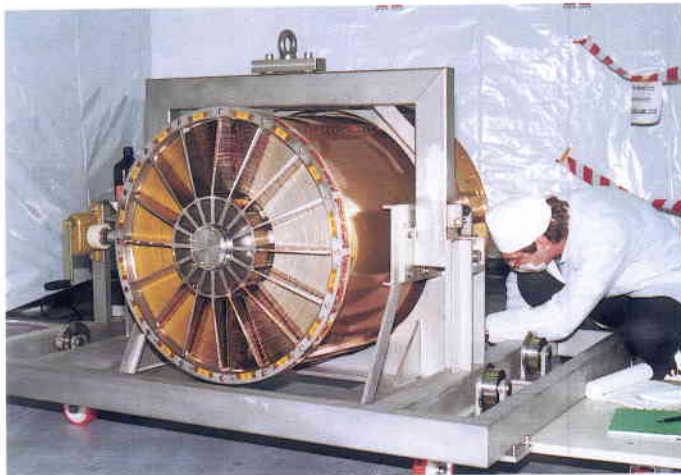

## Test Facilities

The Max-Planck Institute (MPE) X-ray vacuum test facility (Panter) consists of a source chamber and an instrument (detector) test chamber connected by a 130 m-long tube. The instrument chamber (13 m long and 3.5 m in diameter) is equipped with an optical bench on which the XMM QM Mirror Module was mounted. The qualification Mirror Module (Fig.16) was tested in full illumination at X-ray energy levels of 1.5, 4.5 and 8 keV with two different detectors: the Position-Sensitive Proportional Counter (PSPC) developed by MPE for the Rosat satellite, and a Charge-Coupled Device (CCD) camera.

The Centre Spatial de Liège (CSL) is an ESA-coordinated facility which provided the following test facilities for the XMM Mirror Module programme: the Extreme Ultraviolet Vertical (EUV) facility (Focal X), a thermal-vacuum test chamber (Focal 2), and a shaker for vibration testing. The Focal X optical facility provides a vertical collimated beam with a full aperture at 30 and 58 nm and several X-ray channels (pencil beam and collimated beam for reflectivity and scattering measurements). This large facility (4 m diameter and 10 m high vacuum chamber) was specially built for XMM under the leadership of the XMM Project Team and ESTEC's Testing Division.



Figure 15. Focal-X facility of Centre Spatial de Liège (CSL) with the qualification-model Mirror Module inside ready for testing

Figure 16. The qualification-model Mirror Module (above left: general view; below left: exit plane) ready for X-ray testing in MPE's Panter facility

Table 2. X-ray image quality of the QM Mirror Module at best focus

Test		Before environmental test			After environmental test		
Detector	Performance	1.5 keV	4.5 keV	8 keV	1.5 keV	4.5 keV	8 keV
CCD camera	FWHM	9.6"	not done	10.2"	10.5"	not done	10.9"
	HEW	17.1"	not done	14.5"	17.8"	not done	15.3"
PSPC	HEW *	16.8"	16.7"	< 15"	17.3"	19.1"	14.7"
* PSPC intrinsic resolution subtracted	W90 effective area	110" <sup>2</sup> 253 cm <sup>2</sup>	216" <sup>2</sup> 179 cm <sup>2</sup>	290" <sup>2</sup> 96 cm <sup>2</sup>	120" <sup>2</sup> 249 cm <sup>2</sup>	193" <sup>2</sup> 175 cm <sup>2</sup>	236" <sup>2</sup> 93 cm <sup>2</sup>

Table 3. Image quality of the QM Mirror Module at best focus from CCD measurement at CSL

Pre-vibration		Post-vibration		Post thermal	
FWHM	HEW	FWHM	HEW	FWHM	HEW
11.9"	20"	10.8"	19.6"	9.6"	20.6"

**Optical results at MPE and CSL**

The image-quality figures for the qualification-model Mirror Module are summarised in Tables 2 and 3.

All of the X-ray and UV measurements – resolution, focal length, and X-ray reflectivity – made at MPE and CSL before and after the environmental tests were identical to within the measurement accuracy of the facilities, indicating that there had been no optical degradation of the qualification-model MM due to that testing (Fig. 18).

Performance at 8 keV is better than at 1.5 keV because of the lower effect of the large mirror

size at this energy level, and because of the better quality of the inner mirror shells.

The effective area is 15% lower than the theoretically achievable value, due not to the reflectivity of the mirrors (better than 95% of the theoretical value), but to the geometrical constraints of the Panter facility (finite source distance) vis-a-vis the geometry of the mirrors.

The UV results (HEW, FWHM) are slightly worse than for X-rays. The most probable cause is near-edge mirror deformation which cannot be detected in the Panter facility (finite source distance).



Figure 17. Artist's impression of the XMM spacecraft, with its three X-ray telescopes (courtesy of Visulab)



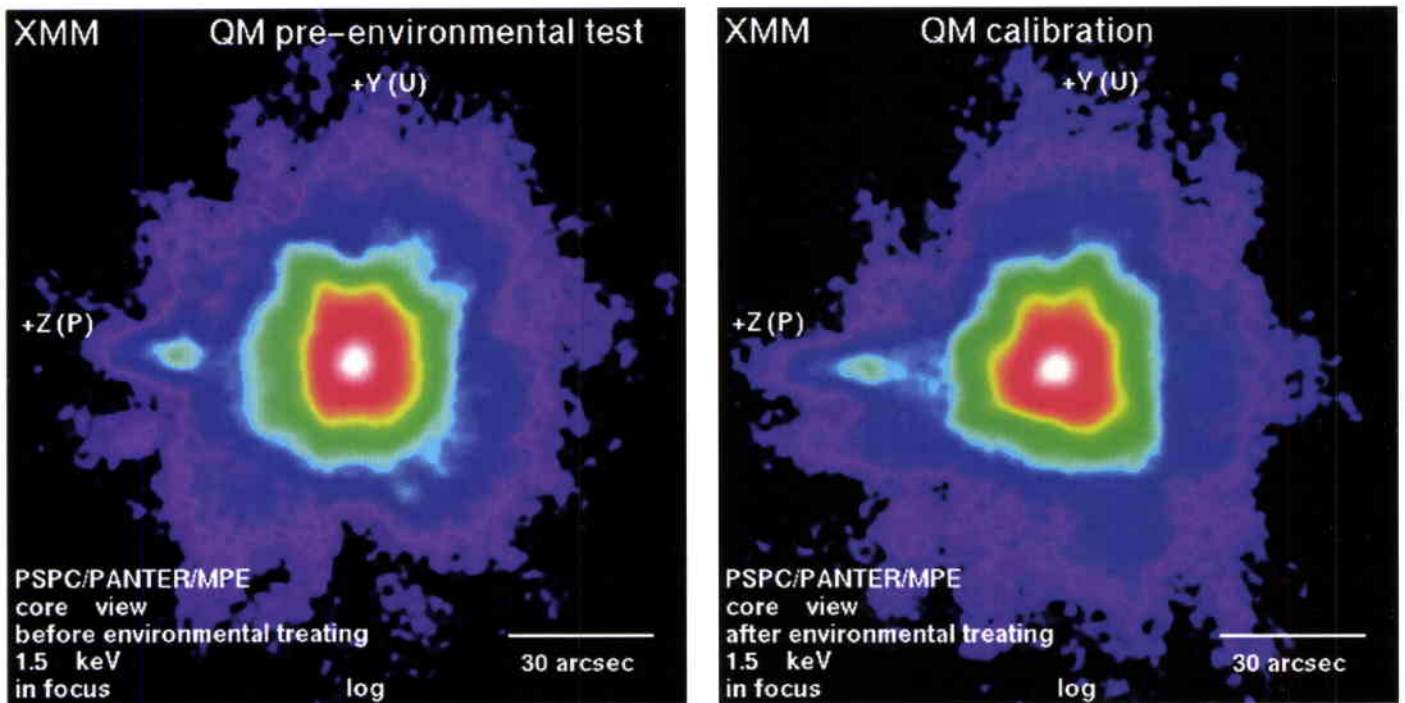

The tests were completed by optical tests performed with various thermal gradients applied to the Mirror Module. All of these tests confirmed the limited sensitivity of the Mirror Module to any radial or axial thermal gradients.

### Conclusion

The development work on XMM's X-ray mirrors is well on track to achieve the performance goals that have been laid down. The continuous efforts undertaken under direct ESA management to improve both the quality and consistency of the mirrors have clearly been successful:

- the optical quality of the mirror shells is well within specification and stable
- the qualification-model Mirror Module has been delivered on time and has a resolution performance consistent with the 20 arcsec in-orbit requirements
- the vibration and thermal tests on the qualification-model Mirror Module showed no signs of optical performance degradation or structural-integrity problems.

Flight-model Mirror Module production has now been started as planned: two will be delivered early in 1997 and the remaining ones should be delivered by mid-1997 for acceptance and calibration testing. Current predictions are that the flight-model Mirror Modules will be of even higher quality than the qualification models.

Based on current knowledge, the metal electro-forming technology can certainly be further improved to deliver lightweight thin mirrors with still better resolutions than those required for XMM. Possibilities to be explored

include the electro-forming of nickel alloys or other metals with better mechanical properties than pure nickel. The current state of the XMM X-ray mirror technology is already good enough to ensure the feasibility of missions like XIUS.

### Acknowledgement

We would like to take this opportunity to congratulate the industrial team on the excellent results achieved so far, especially Dr. H. Rippel and G. Grisoni of Media Lario, D. Kampf of Kayser-Threde, W. Egle of Carl Zeiss, and A. Pugin and C. Jabaudon of APCO.

The members of the Telescope Advisory Group, Dr. B. Aschenbach and Dr. H. Bräuninger of MPE-Garching, Dr. P. de Korte of the Netherlands Space Research Organisation, Dr. R. Willingale of the University of Leicester, Dr. O. Citterio from Brera Astronomical Observatory and the many participating ESA personnel are also thanked for their continuous support.

The contributions by A. Hawkyard in the early phase of the mirror development effort are also gratefully acknowledged. ©

**Figure 18. X-ray focal image of the QM Mirror Module (at 1.5 keV) before and after environmental testing (courtesy of MPE-Neuried)**

## Atlas of Images of the Nucleus of Comet Halley

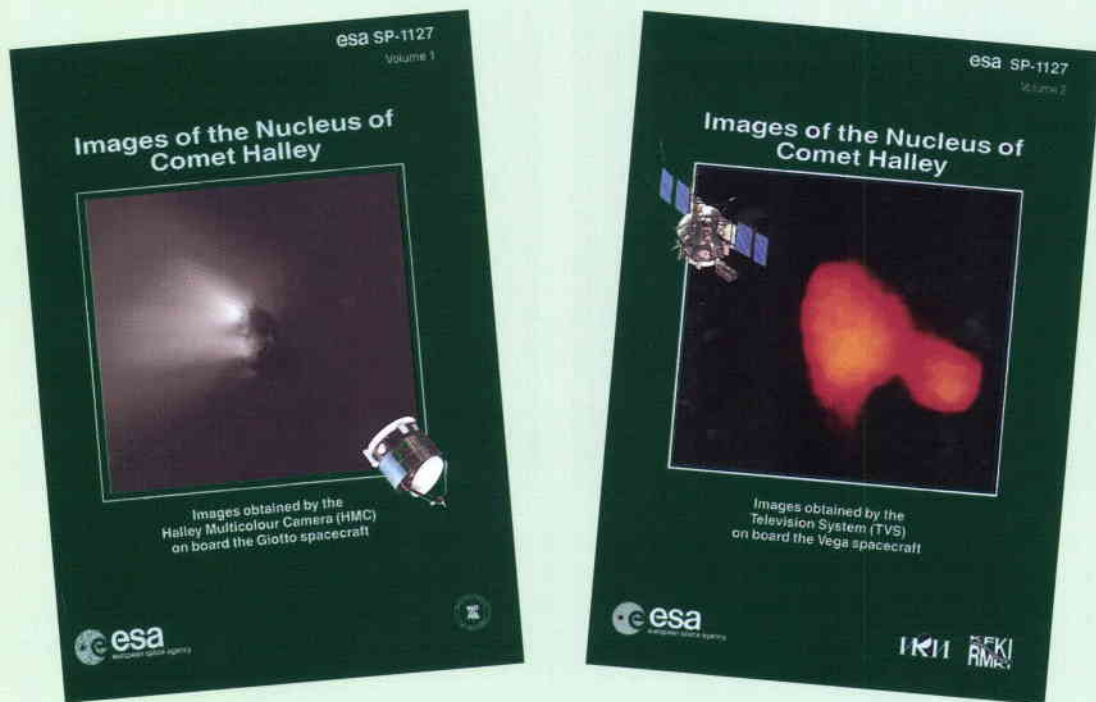

Apparitions of Comet Halley have been recorded regularly in history since 240 BC, but it was not until its 1066 AD apparition that it was first depicted visually, and then only in a very stylistic manner. The first accurate scientific drawing of Comet Halley was made in 1682 by Hevelius. Further drawings with increasing detail were made during the 1759 and 1835 apparitions, and the first photographic plates were made during Halley's return in 1910. By the time Halley next returned in 1985/6, space flights to comets were possible and it was met by an armada of five spacecraft, three of which – Giotto, Vega-1 and Vega-2 – carried high-resolution cameras. These images revealed the existence of a cometary nucleus for the first time.

Volume 1 of this Atlas is devoted to the images obtained by the Halley Multicolour Camera (HMC) aboard ESA's Giotto spacecraft. It includes a brief description of the project, an account of the image processing and calibration procedures, and a summary of the scientific results to facilitate interpretation of the images.

In Volume 2, the consecutive sequences of images obtained by the imaging experiments aboard the Russian-led Intercosmos spacecraft Vega-1 and Vega-2 are presented and the most important scientific results obtained from these images are described.

ESA SP-1127

Volume 1: 252 pages

Volume 2: 254 pages

Price (both vols.): 100 Dutch Guilders

Available from: ESA Publications Division  
(Order Form inside back cover of this Bulletin)

# The Evolution of ESA's Spacecraft Control Systems

**A. Baldi, M. Jones, J.F. Kaufeler and P. Maigné**

Flight Control Systems Department, European Space Operations Centre (ESOC), Darmstadt, Germany

## What is a spacecraft control system?

A spacecraft control system is used to operate a spacecraft from the ground. The more general term 'Mission Control System' (MCS) is commoner these days and will be used throughout this paper. The MCS covers the needs of the whole mission, including support to preparing operations, in addition to the spacecraft operations themselves; it can also cover the ground-system operations.

---

**ESOC first developed a reusable spacecraft control infrastructure back in 1974 and this article traces the development of the Agency's spacecraft control system technology since then, through several, ever more advanced generations of infrastructure:**

- the Multi-Satellite Support System (MSSS)
- the Spacecraft Control Operations System (SCOS), which itself exists in two generations, SCOS-I and SCOS-II.

**The process of implementation and upgrading has been more evolutionary than revolutionary, but the advances within each generation and from one generation to the next have nevertheless been considerable.**

---

The MCS consists of a computer system connected to one or more ground stations, which are responsible for communication with the spacecraft. Via these ground stations, the MCS receives telemetry data from the spacecraft, which it uses to monitor the spacecraft's health. The MCS controls the spacecraft by sending it telecommands, which are in effect instructions to the spacecraft. An MCS thus operates on the same principles as a process control system, in which the process is monitored via readouts from sensors and controlled via commands to the process. The telemetry data contain so-called 'house-keeping' parameters; typically these are regularly sampled onboard the spacecraft to provide information about its subsystems. These parameters can contain analogue values, e.g. battery charges and currents, temperatures of particular components, or

binary values, e.g. an on/off indication for an onboard experiment.

The classical core functions of a Mission Control System are:

- Monitoring of telemetry parameters to check that they are either within certain ranges – 'limits checking' – or that they have certain expected values – 'expected status checks'; this monitoring can also include computation of 'derived parameters' from raw telemetry parameters.
- Commanding of the spacecraft; typically, the sending of a command will involve Pre-Transmission Validity (PTV) checks to verify that the command is permitted, and Command Execution Verification (CEV) to ensure that the command has been executed properly onboard. Such checks are typically made by examining telemetry parameters, e.g. to be sure that a heater has been turned on following a switch-on command. Commands may be sent manually or automatically. In manual commanding, the spacecraft controller will send commands from an application called the 'manual stack': this is, in effect, a list of commands prepared on a special display which are sent by 'popping' them off the top of the stack. In automatic commanding, a schedule of commands (in effect a list with times assigned) is sent automatically by the system.
- Filing of all telemetry and telecommand data in history files, for later analysis or display.
- Displays of data to operations staff (displays either in real time or retrieved from files); classical types of display are:
  - Alphanumeric Displays (ANDs): basically these consist of lists of parameter names and their values arranged in columns. Parameter values can be displayed in raw (i.e. as in the telemetry data) or calibrated form (i.e.

- converted into engineering values, e.g. volts, degrees Celsius,...)
- Graphical Displays (GRDs): these are basically strip-chart plots of a parameter against time, or one parameter against another.
- Alarm facilities to draw the attention of operations staff to anomalies: typically an out-of-limits or another type of failed check will result in an audible and visible alarm, which requires explicit acknowledgement by the operator.
- Security facilities, to prevent unauthorised external access to the system and to control access to the various functions of the system within the control team; the limiting of access to commanding functions is a typical example.
- Facilities to set up and maintain the spacecraft database, which describes the characteristics of the telemetry data, telecommand and other mission data. These are often referred to as 'mission-preparation facilities'.

The above description is somewhat simplified, but covers the basic principles.

One of the challenges of building a Mission-Control System is to provide the above functions in a user-friendly and easily configurable way. In addition, performance and reliability are big challenges:

- Performance is important for a number of reasons. During the Launch and Early Orbit Phase (LEOP), typically 12 to 15 operator positions have to be supported, and users require a good response at their work stations at all times. More complex

spacecraft can have in the region of 6000 or more parameters to be regularly monitored or computed, which implies quite a heavy work load. On missions with limited ground-station contact, it may be necessary to uplink a long schedule of commands within a matter of minutes.

- Reliability is important since the system must not be susceptible to major failures. Basically this is because full control of the spacecraft is needed during critical phases, such as during the deployment of solar arrays in the LEOP when the necessary operations have to be completed within a few orbits otherwise the mission may be lost. Recovery times are typically requested to be in the order of a few minutes, possibly with no interruption of certain key functions (e.g. telemetry monitoring).

### The Multi-Satellite Support System (MSSS) MSSS first generation

The very first reusable MCS was the first-generation MSSS put into service for the first time in 1976, for the Geos-1 scientific satellite mission.

With the processing powers of conventional computers at that time, the functions and performances required could not be provided by a single unit but had to be distributed over several computers. A combination of Siemens-330 minicomputers (front-ends) and CII-10070 (back-ends) mainframes was employed, using the architecture shown in Figure 1.

This network of computers was expensive and to be cost-effective had to be able to support

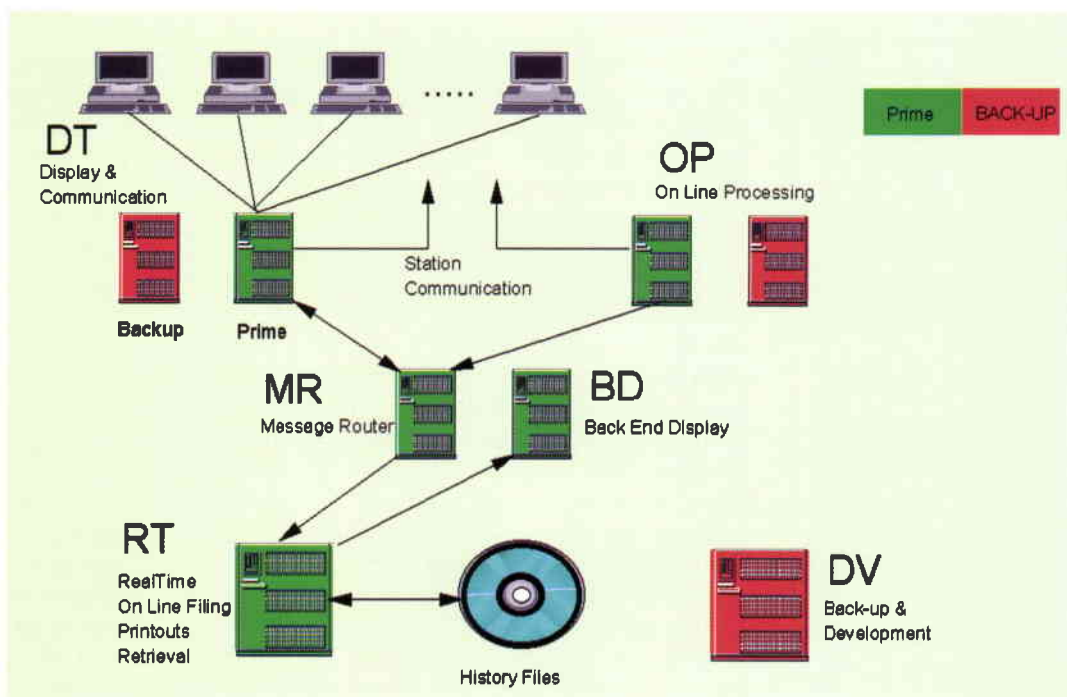

Figure 1. The first-generation MSSS

several missions in parallel. To achieve this it was decided the software should be data-driven, by files describing the spacecraft characteristics and the configuration of the control system itself.

The first MSSS was made up of the following computers:

- The On-line Processing front-end, which received telemetry from the ground stations and processed it for monitoring purposes before transferring it to the DT and RT computers.
- The Display Terminal front-end (DT), which drove single-screen user displays equipped with standard functional keyboards.
- The Message Router, which was intended to make the various hardware (backup) reconfigurations transparent.
- The Real-Time back-end (RT), which filed all data routed from the Message Router, serviced data-retrieval requests and performed daily printouts. It also held the spacecraft database and its associated maintenance software. The Development back-end (DV) was the RT's backup and in nominal operation was used as a development and maintenance computer.
- The Back-end Display computer, which was the backup for the Message Router, but was also the relay for retrieval requests issued from Display and Terminal front-end.

Because of the limitations of the computers of that time (the Siemens 330 had only 64 kbytes of main memory!), the system had to be written in assembly language to achieve efficiency and

compactness. The communication techniques were engineered in-house. Consequently, the system was expensive in terms of testing and maintenance effort. The system was able to support a total telemetry rate of 60 kbit/s for three to four spacecraft concurrently, with up to 15 single-screen displays.

### MSSS second generation

Given the complexity of the above system, and the advent of much more powerful computers, it was decided in the late 1970s to use a single computer to host all of the MSSS software. This had the advantage of simpler software and a simpler backup procedure. Because missions were still being operated using the existing system, however, the move to the new system was made in two steps:

- replacement of the CII computers by much more powerful SEL/Gould 32/77 machines, replacing the RT and DV machines and resulting in the so-called 'interim MSSS', which went into operation in 1979, and
- migration of the tasks of the various peripheral computers to the SEL/Gould, to produce an MSSS fully resident on the SEL/Gould computers, which was completed in 1984; this resulted in the second generation of MSSS, known as MSSS-A (Fig. 2).

At the completion of each step, the old system and the new system were run in parallel on currently operational missions, thereby allowing extensive testing of the new system and building user confidence.

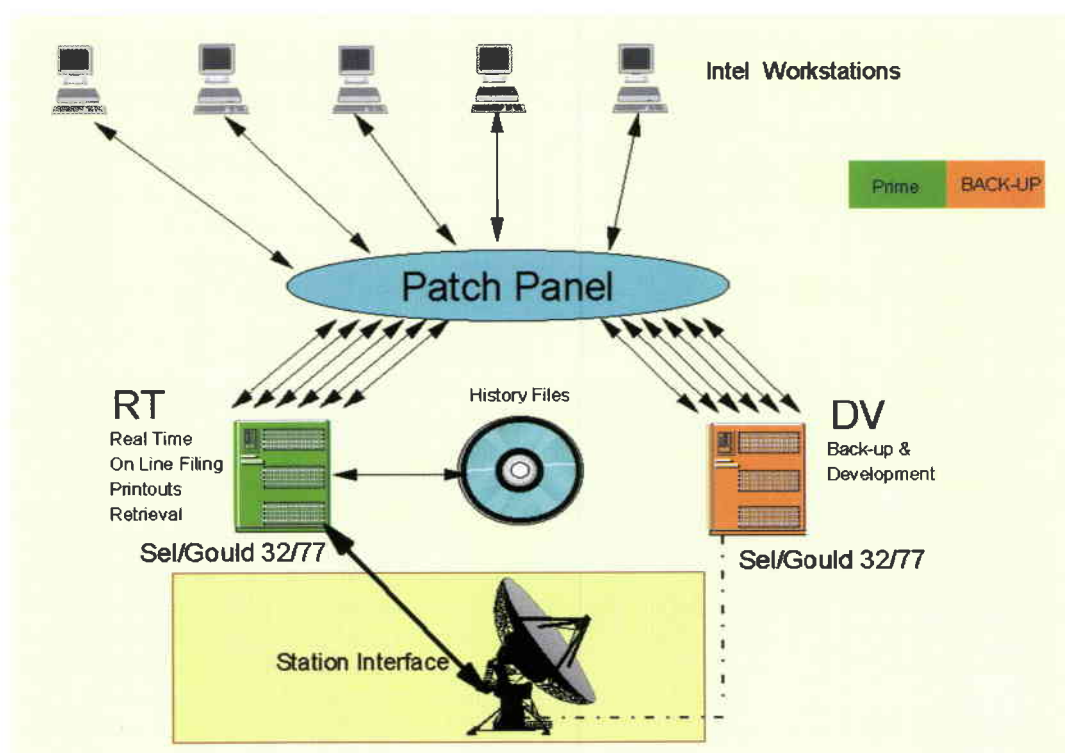

Figure 2. MSSS-A

The final MSSS-A shown in Figure 2 heralded another interesting advance in that it used a three-screen work station based on an Intel microprocessor, replacing the 'dumb' terminals commonly in use at that time. Much of the screen data presentation processing was performed on these work stations, thereby relieving the host application of the burden of formatting the screens. These Intel work stations were connected to the host with a serial V24 interface via a switch panel, thus allowing reconfiguration of work stations between host computers.

The performance of MSSS-A was much better than the first-generation MSSS. In particular, it was able to support simultaneous operation of up to 14 three-screen work stations (a circa three-fold improvement). The overall telemetry rate supported was still about 64 kbit/s.

### Advances of MSSS

#### *The spacecraft database*

Undoubtedly, the towering achievement of MSSS was its development of the concept of a spacecraft database (although it was not called that at the time), whereas earlier ESOC control systems had all been mission-specific. MSSS made extensive use of 'table-driven' techniques to define the telemetry and telecommand characteristics of the missions. This included the specification of length and type of parameters, essential for an infrastructure usable for different spacecraft. In effect, it used data-description techniques when such approaches were little known. The contents of the various displays and other system parameters were also defined in the database, laying the foundations for the concept of a Mission Information Base containing all static mission data. In practice, the first MSSS 'database' was a simple sequential text file (it was originally a card file!) which was then converted into tables that could be used efficiently at run-time.

#### *Other MSSS advances*

These included:

- The establishment of new display and user-interaction techniques, in particular form-filling techniques and function keyboards, both of which were unusual at the time. They reduced the volume of instructions to be entered via the usual QWERTY-type keyboard, thereby increasing user comfort and reducing data-entry errors.
- Achievement of state-of-the-art performance for that time, through a careful mapping of tasks onto a distributed system.

The advances of the second generation, MSSS-A, were:

- the hardware environment was more homogeneous and simpler
- all the software was written in a high-level language (Fortran)
- the use of the custom 'Intel' work stations off-loaded data presentation from the central host computer, thereby greatly increasing the number of user screens/displays which could be supported.

The first two points made the system easier to maintain. The simpler configuration and use of the switch panel to interconnect work stations made recovery from host-computer failures faster and easier.

### SCOS-I

In 1984, ESOC had to decide which MCS infrastructure should be used for the Hipparcos, Eureka, and ERS-1 missions. The needs of these missions, with their demanding mission-specific tasks and higher telemetry rates, could not be accommodated with an MSSS-A configuration, even by running it in a single-spacecraft mode. In addition, Eureka had adopted new packet-telemetry and telecommand standards which were not supported by MSSS.

The concept of a single hardware configuration to be shared between different missions (like MSSS) was abandoned because of the sharp fall in the cost of computer hardware. In addition, there would have been difficulties in running such different missions on a single computer configuration. This led to the idea of using a dedicated hardware configuration for each mission. Each such dedicated hardware configuration took the form of a redundant pair of DEC/VAX computers – a real-time (RT) computer and a backup and development (DV) machine. The power of the VAX was dependent on the load profile of the particular mission. The approach was thus a centralised one and a new infrastructure called the 'Spacecraft Control and Operation System' (SCOS) was implemented to support this new approach.

### SCOS-A

The initial implementation of SCOS – the DEC/VAX resident part eventually became known as SCOS-A – re-used the Intel-based work stations since these were a relatively recent investment at the time SCOS-A development began (1984). SCOS took over the user requirements of MSSS. However, for financial reasons no generic telecommand system was developed, but care was taken to allow for easy interfacing of telecommand-related applications. Schematically, the hardware configuration for each mission (Hipparcos, ERS-1 and Eureka) was similar to

that depicted in Figure 2, with the SEL/Gould machines replaced by machines of the DEC/VAX series. Of course, the SCOS-A software system running on each such configuration was completely different.

**SCOS-B**

Between 1989 and 1991 the (by then) obsolete Intel work stations were replaced with off-the-shelf SUN work stations. ESOC developed Intel emulation software to retain full compatibility with the existing host-resident applications to allow 'plug-compatible' replacement of the Intel work stations. The software on the SUN was referred to as SCOS-B. The implementation on the SUN side was done in Ada and C under SunOS, the standard SUN operating system at that time. SCOS-A (DEC/VAX part) and SCOS-B (SUN part) together form what is known today as SCOS-I.

A later development was the use of the network TCP/IP communications protocol to replace the serial V.24 interface connecting the work stations to the host computer, which also involved modifications on the host (SCOS-A) side. This permitted interconnection of the VAX and the SUN work stations using a Local Area Network (LAN), thus making the patch panel used on MSSS-A and the initial SCOS implementation obsolete. The result was even easier switching of the work stations between host computers. Figure 3 shows a complete SCOS-I set-up for several missions, including the common operations LAN (OPSLAN). The OPSLAN is itself redundant (although this is not shown in Fig. 3).

SCOS-B was used for ERS-1, ERS-2, ISO, and was also prepared and validated for the Cluster mission. It is also planned to be used for the Envisat and XMM missions.

**Advances of SCOS-I**

SCOS-A advances were:

- Handling of both packetised and fixed-format telemetry. While packetised telemetry is a major benefit for the overall space and ground system, it represents a considerable increase in complexity for the ground system, which has to handle multiple packet types and formats. It also has to deal with a number of associated problems, such as handling parameters which are repeated in packets of different type, derived parameters calculated from raw parameters originating in packets of different type, etc. This aspect of SCOS-A was thoroughly validated by the Eureka mission.
- Use of a commercial relational database system (ORACLE) as a basis for building source database editors to support mission preparation. This gave powerful tools both for consistency-checking the spacecraft database and for preparing searches and reports on it.

SCOS-B made the key advance of using the X11 protocol, which enables applications to make use of modern WIMPS (Windows, Icons Mouse Pop-Up Menus) and Graphical User Interface (GUI) techniques. This in turn permitted: many more displays than the physical number of screens on a work station, via for example overlapping windows; use of

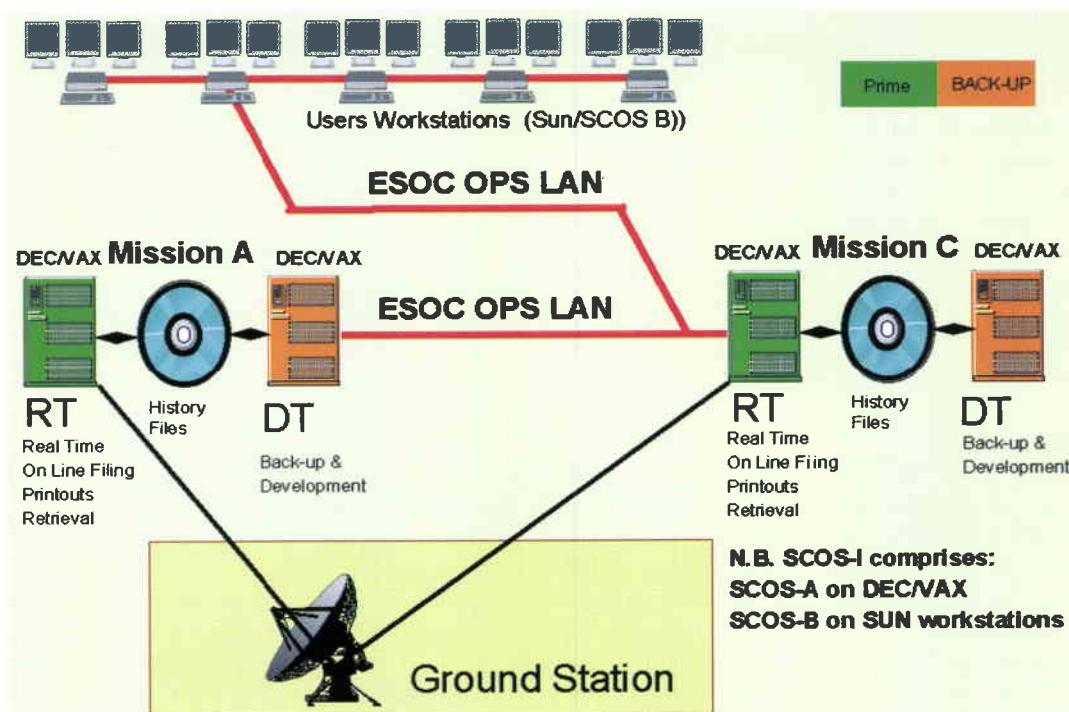

Figure 3. SCOS-I

mouse as an alternative to the keyboard; and the use of menus to start/stop/control applications. It also permitted a new kind of 'mimic' display, consisting of a schematic representation of a spacecraft subsystem that can be driven by the actual values of telemetry parameters, e.g. switches can be shown whose settings react to on/off parameters in the telemetry. The example shown in Figure 4 is, in fact, taken from a later infrastructure, SCOS-II, but the mimics on both systems are very similar.

In conclusion, the major advances of SCOS-I were both functional and technological:

to particular hardware platforms and their vendors

- simplify maintenance and operations by using a compatible, homogeneous set of hardware: previous infrastructures used a mixture of platforms from different manufacturers (e.g. DEC, SUN on SCOS-I)
- provide the means of building systems which can be easily scaled to different missions or mission phases, e.g. by adding work stations (MSSS-A and SCOS-I were centralised and the number of work stations that could be added was limited by the power of the central host computer)
- allow easier re-use or customisation of the

Figure 4. Example of a mimic display

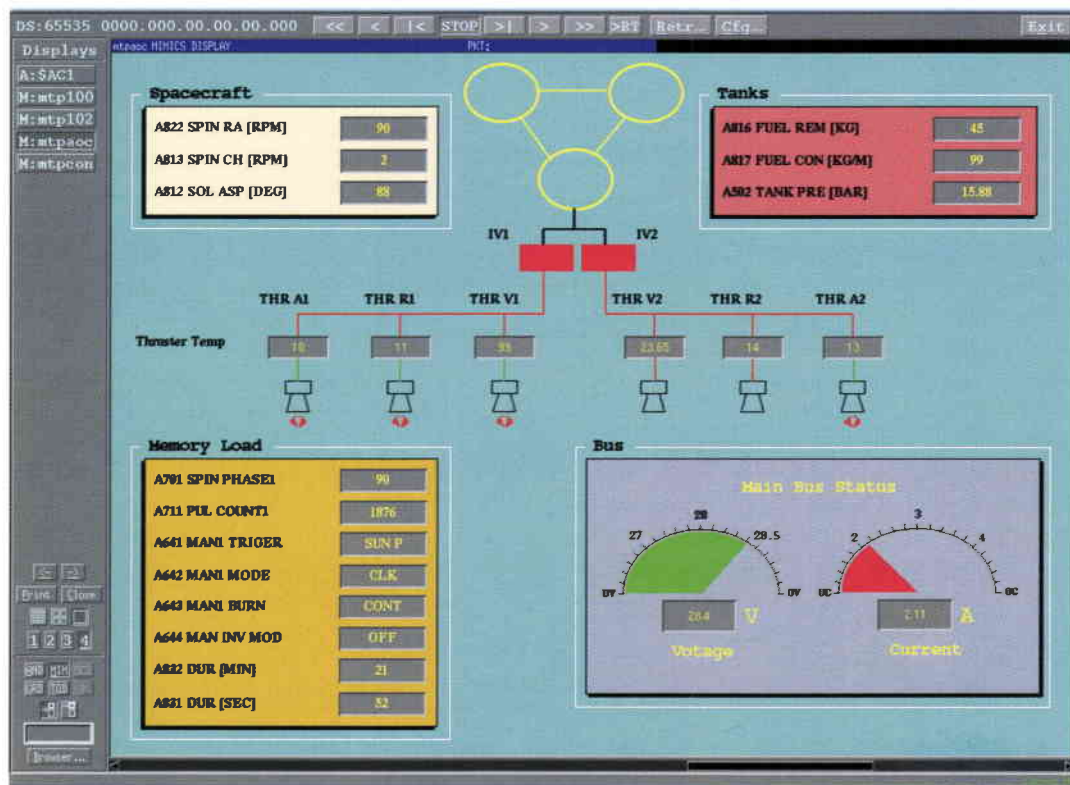

functional in terms of the handling of packet telemetry, and technological through the use of more powerful computers, the use of a commercial database system for maintenance of the mission database, the introduction (in SCOS-B) of modern work stations and the X11 protocol to provide modern WIMPS/GUI interfaces, and finally the introduction of the TCP/IP protocol and LAN technology,

**SCOS-II**

**Aims**

The development of SCOS-II began in 1992 and is intended as a completely new replacement of SCOS-I, which it was foreseen would become obsolete in the late 1990s. Its aims are to:

- achieve vendor independence: previous infrastructures were based on vendor-specific operating systems which were tied

infrastructure. SCOS-I is implemented in Fortran using functional decomposition design methods, but this technology is not best suited for reusable software and the Information Technology industry is increasingly moving towards more modern languages such as C, C++ and JAVA

- reduce the amount of software to be implemented by using industry standards and Commercial-Off-The-Shelf software (COTS).

**SCOS-II approach**

SCOS-II addresses these points as follows:

- To achieve vendor independence, it uses UNIX System V, Release 4, which is supported by a large number of vendors. The current choice of operating system is Solaris 2.x, which is UNIX System V, Release 4 compliant.



- SCOS-II uses a homogeneous network of UNIX work stations (presently SUN).
- SCOS-II achieves scaleability through the use of a distributed architecture, as discussed later; it is flexible and permits the building of systems ranging from compact single-work-station systems to large multi-work-station systems.
- SCOS-II is implemented using object-oriented techniques, which permit better reuse by means of its property of inheritance. The chosen implementation language is C++.
- Industry standards used include TCP/IP, X11 and OSF/MOTIF. A number of COTS

be distributed flexibly according to mission needs. With SCOS-II, each user work station will typically run one or more telemetry-processing tasks and the associated displays, so there is little or no interference between clients. Tasks such as commanding, retrieval, archiving, etc. can be similarly distributed. The client mission examples shown in Figures 7 and 8 represent two extreme cases, an extended distributed configuration and one on a single work station.

**Advances of SCOS-II**

In its present implementation, SCOS-II has monitoring facilities equivalent to or better than

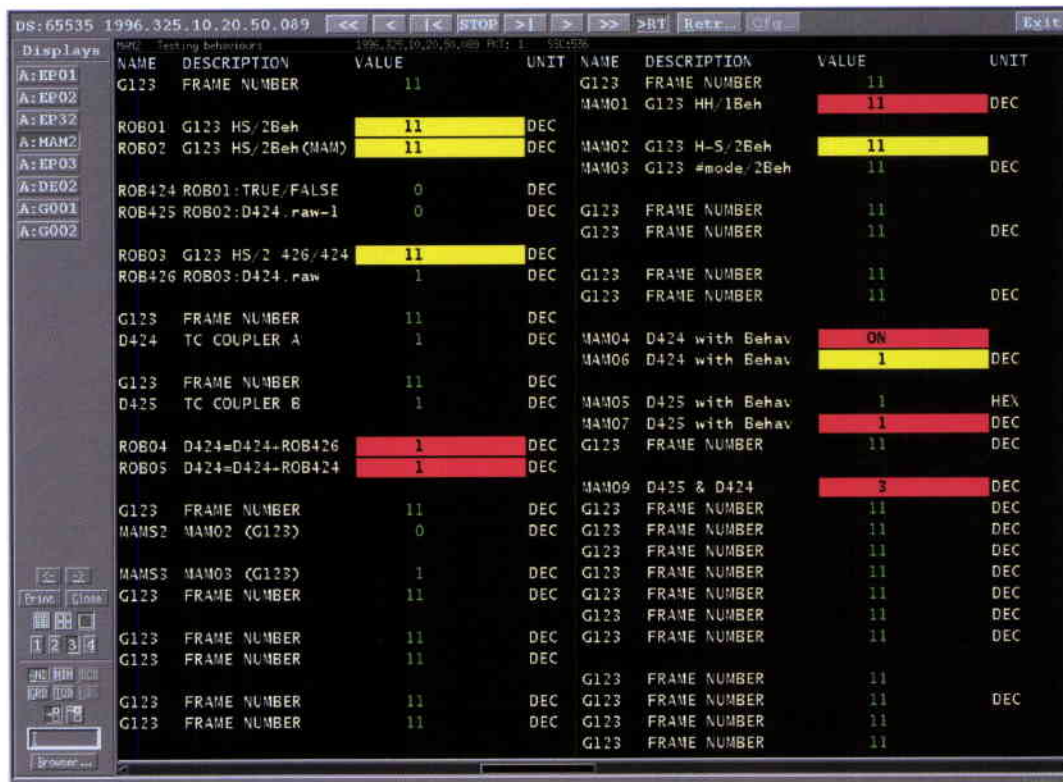

**Figure 5. The SCOS-II 'display container' concept**

packages are used, most notably ILOG VIEWS for building MMIs and ctreesPLUS (from Faircom Corporation) for file management.

**SCOS-II system architecture**

SCOS-II achieves scaleability by devolving processing to the user work stations as far as possible. This is achieved by: (a) broadcasting telemetry data to all user work stations (rather than making point-to-point transfers to all work stations, i.e. one transmission on the network replaces  $n$ , where  $n$  is the number of work stations); (b) providing data caches at each work station, so that the user work station can normally get data from its local cache, thereby reducing network loading.

SCOS-II is based upon the client-server paradigm, allowing client and server tasks to

those of SCOS-I (see below for the advanced features). It has an incomplete telecommand subsystem; despite this, elements of its telecommand facilities have been successfully customised and extended for its three client missions.

A selection of SCOS-II's advances are:

- The display area, called the 'display container' (Fig. 5), can hold as many individual displays as the user wants to configure (subject to the load capacity of the workstation), with simple navigation (e.g. clicking on the buttons).
- The general SCOS-I database approach is retained, with translation of an ORACLE source database into efficient run-time form. Improvements have been made in that: (a) the database has been reorganised ('normalised') so that the power of the

- ORACLE tools can be used for consistency-checking, thereby reducing the amount of custom code to be written, and (b) the run-time 'database' is a persistent object store, which allows online changes.
- A powerful telemetry query display is provided: by simply clicking on the parameter name in a dialogue box, it will display all of the information known about that parameter, e.g. its value, limits and validity. This can include both dynamic information (e.g. value, validity) and static information (e.g. limits, calibration data, etc.). Figure 6 shows an example of a

telemetry query display in which limits have been selected.

- Instantaneous switching between prime and backup components can be effected by a simple mouse click. In the event of failure of one server, the data can be re-routed to the relevant tasks on the client machines, without any need to re-start them.
- A generic On-Board Software Maintenance (OBSM) facility, to permit packaging and transmission of software and other data (onboard images) to onboard computers, and to dump and compare downlinked images.

ID	LO	HIGH	VALUE	APP CRIT	CRIT VAL	NUM VIOL	MAX VIOL	TOOL STATE
EPG123	6	9	14	T	0	1		HIGH
EPG123	3	12	14	T	0	1		HIGH HIGH

Figure 6. The SCOS-II telemetry query display

The performances achieved using recent releases of SCOS-II are good. For the Huygens mission, for example, playback data rates of 120 packets/second have been achieved on a SUN Sparc 20 work station (about double that for the Eureka SCOS-A system), this enhanced performance resulting from the combination of the new hardware and the SCOS-II approach. At the same time, SCOS-II is still a young system and there are areas where further optimisation is needed.

#### SCOS-II client missions

The current client missions are SOHO, Huygens and the LEOP (Launch and Early Orbit Phase) of the Meteosat Transitional Phase (MTP) spacecraft. Also, the Envisat OBSM system will be based on the SCOS-II OBSM, while its spacecraft control system is based on SCOS-I.

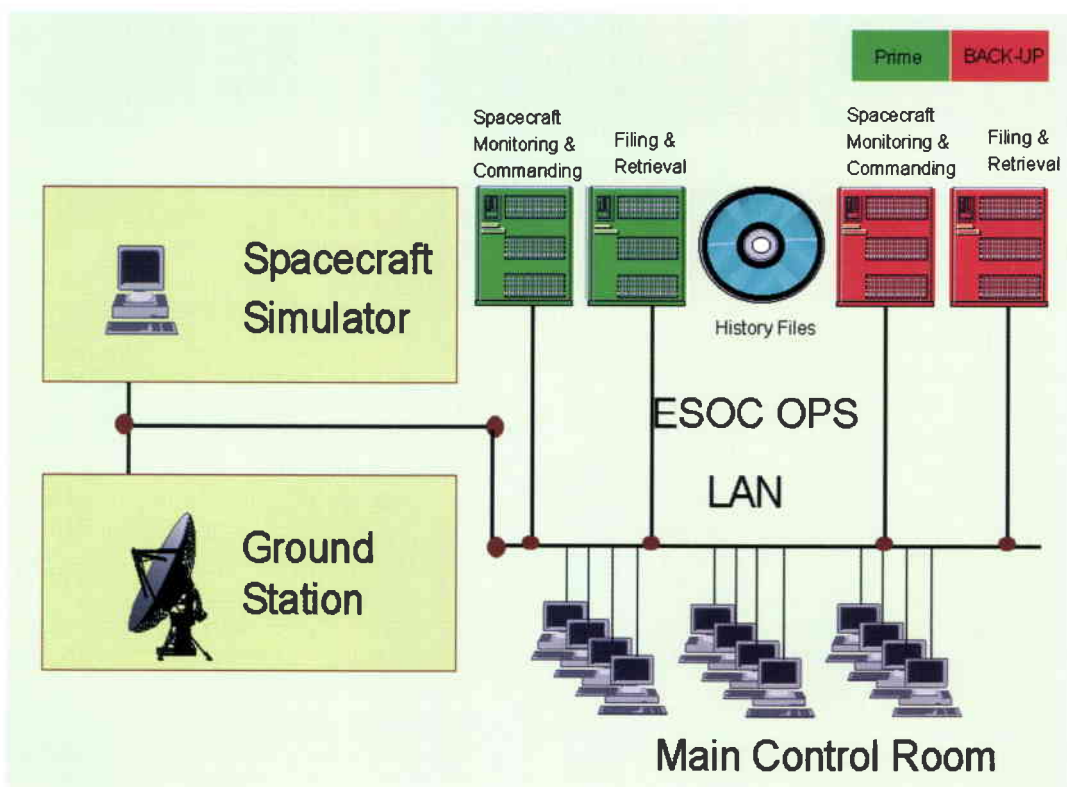

Figure 7. The MTP SCOS-II configuration

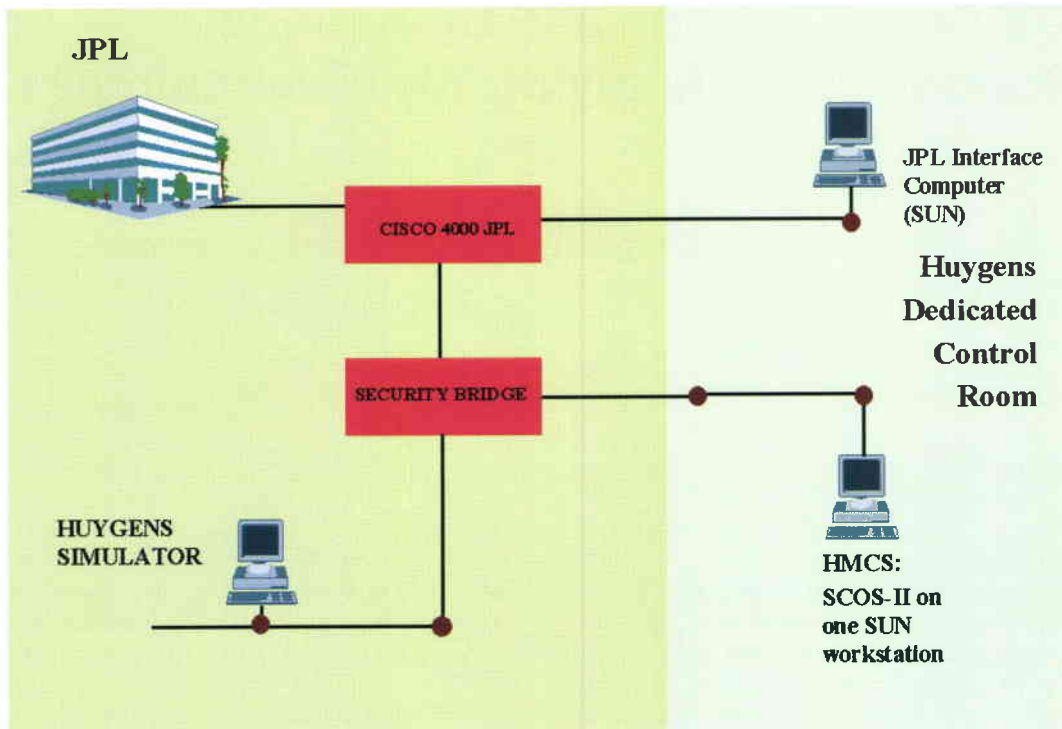

Figure 8. The Huygens SCOS-II configuration

For the SOHO project, SCOS-II has been used since the satellite's launch (in November 1995) to complement the nominal control system, primarily in the area of historical telemetry data retrieval and monitoring. This system was set up at the control centre (at a non-ESA site, namely Goddard Space Flight Center, Maryland, USA) at very low cost and at short notice (about two months).

The MTP LEOP, scheduled for September 1997, will involve a total of 11 client workstations and two servers, one dealing with centralised-type tasks (limits checking) and the other handling retrievals (so that heavy retrievals use will not affect the rest of the system). This fully distributed configuration is shown in Figure 7.

SCOS-II will be used to support the Huygens Probe for the joint NASA/ESA Huygens/Cassini mission. This deep-space mission to study Saturn's moon Titan is due for launch in late 1997. The control system has recently been successfully tested in an on-ground System Validation Test with the Probe (Fig. 8).

### Conclusions

This brief summary has shown that, over more than 20 years, ESOC has undertaken six major implementations or upgrades of its MCS infrastructure. The MCS architectural concept has changed considerably during this period, starting with a distributed architecture (MSSS first generation) and then moving to an essentially centralised architecture (MSSS-A, SCOS-A/B), SCOS-II, the successor to SCOS-A/B, returned to a basically distributed

approach, although not the rigid one of the MSSS first generation. In fact, it permits any chosen degree of distribution, since the mapping of tasks on the network is flexible, varying from a non-distributed 'SCOS-in-a-box' approach to the highly distributed approach of the MTP LEOP configuration. It has come to be recognised, however, that even in a distributed implementation, certain tasks have still to be centralised (e.g. limits checking, telecommand transmission).

It is interesting to note that the overall process of implementation and upgrading has been more evolutionary than revolutionary. For example, SCOS-I took over the centralised architectural concept of MSSS-A and initially it even used the same work stations. SCOS-I also re-implemented the MSSS spacecraft database concept using modern database technology, and implemented packet telemetry. SCOS-B pioneered the use of SUN work stations including the TCP/IP and X11 protocols, and introduced modern WIMPs techniques into the ESOC operations community. In this way, SCOS-I helped prepare for SCOS-II. We believe that today's SCOS-II will help keep ESA at the forefront of the technology that it led with the initial MSSS implementation. ©

# On-Board Training and Operational Support Tools Applying Web Technologies

**J. Auferil & L. Bessone**

European Astronauts Centre (EAC), ESA Directorate of Manned Spaceflight and Microgravity, Cologne, Germany

## Introduction

In preparing for the operation of the International Space Station (ISS), new approaches to astronaut on-board training are being considered. Emerging computer technologies like multi-media (usage of graphics, photographs, animation, sound and motion video) and the World Wide Web, together with the use of equipment simulators and the innovative application of instructional methodologies, are key elements in these new developments.

**A computer-based training and failure-diagnosis system has been developed at the European Astronauts Centre in the context of the Mir missions. It makes extensive use of Web technologies to provide a novel and valuable environment in which astronauts can train themselves not only to carry out nominal/routine in-orbit procedures, but also to cope with non-nominal mission scenarios, in readiness for the International Space Station era.**

Mir 97, the 20-day German mission to the Russian space station Mir, scheduled for February 1997, is to be the test-bed for the Modular On-board Training Environment (MOTE), a series of experiments comprising an integrated training system that includes: a nominal-mission training lesson, a facility simulator, a non-nominal-mission training lesson, and a failure-diagnosis system. The facility chosen for these these training elements is the TITUS furnace, designed for conducting material-science experiments aboard Mir.

## The Modular On-board Training Environment (MOTE)

MOTE is the result of the integration of three originally self-standing elements:

- TITUS furnace emulator
- nominal-operations courseware
- non-nominal-operations courseware and a trouble-shooting tool.

### TITUS furnace emulator

This is a high-fidelity simulation of the TITUS furnace, which receives commands from the facility-control software (TITAN, developed by DLR's Microgravity User Support Centre in Cologne, Germany) and generates responses and experiment data just like the real facility. The emulation provides a point-and-click interface to allow the astronauts to visualise, navigate around and interact with the furnace's exterior and interior. Using this emulation environment, the astronaut can perform the furnace procedures for the electrical installation and run the experiments. This includes such mechanical operations as connecting cables, installing experiment probes, opening and closing hatches, and actuating switches.

The emulator was developed by VEGA Space Systems Engineering GmbH, located in Darmstadt, Germany.

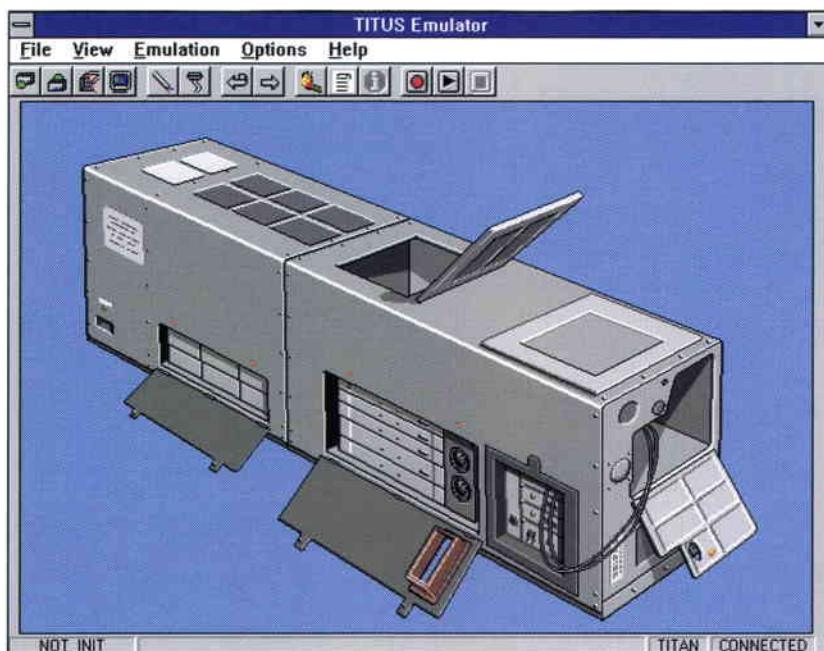

Figure 1. The facility emulator screen

**Nominal-operations courseware**

This element trains the astronaut to perform nominal operations on the TITUS furnace, e.g. starting and shutting down the facility, loading and removing samples, loading an experiment run, starting the run and monitoring its progress. Much of the courseware is orientated towards the facility-control software. During the course of the experiment, some of the training material will be uploaded from the ground using Web technology.

The experiment was developed by the German Aerospace Research Establishment (DLR), located in Cologne, Germany.

**Non-nominal-operations courseware and trouble-shooting tool**

This courseware and trouble-shooting tool is used by the astronauts to identify the causes of failures in the TITUS furnace and to train in how to resolve them. It also provides instructions for a previously untrained-for maintenance activity on the furnace (tube heater cleaning operation).

This tool has been developed by EAC itself.

**The MOTE architecture**

Whilst the above-described experiments will be performed in three separate sessions on-board (see below), their integration allows each of the components to make use of the other two. This interaction between components is illustrated in Figure 4.

The MOTE system, which runs under the Windows NT 3.51 operating system on the Mir 97 laptop (a 75 MHz 486 with 32 MB of RAM), contains the following software components:

**1. Web-based courseware**

This includes both nominal- and non-nominal-operations lessons, a typical lesson being based on:

- *Instructional material:* A set of lesson pages (HTML documents) containing text, graphics, animations and links to other pages
- *A lesson engine:* a program that is loaded when the lesson is called and which provides all of the elements necessary for the lesson's execution, including the user interface, page navigation, progress and contextual information, glossary of terms, etc. The lesson engine has been programmed in Javascript, a scripting language that is embedded in an HTML document and executed by a Web browser when received.

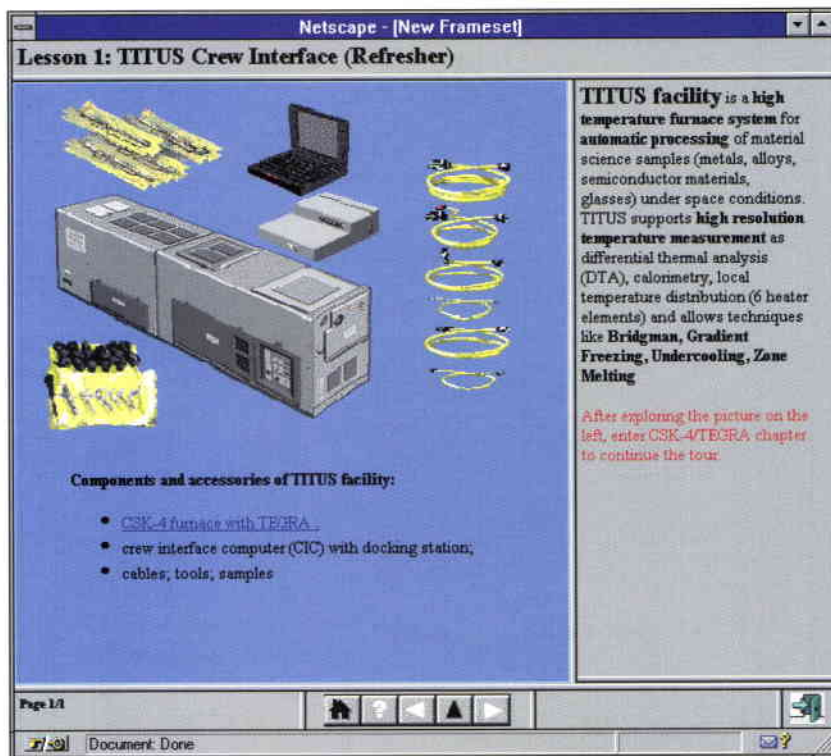

**Figure 2. Nominal-operations courseware screen**

**2. Web-based trouble-shooting**

The trouble-shooting engine is a Javascript-based program that contains all the components of the failure-diagnosis system (user interface, failure symptoms and failure estimations, symptom selection mechanism, estimation mechanism). The tool dynamically generates failure estimations and presents available reference material and non-nominal-operation courseware.

**3. Web server**

This off-the-shelf application gathers and distributes the above-described elements –

**Figure 3. Non-nominal-operations courseware screen**

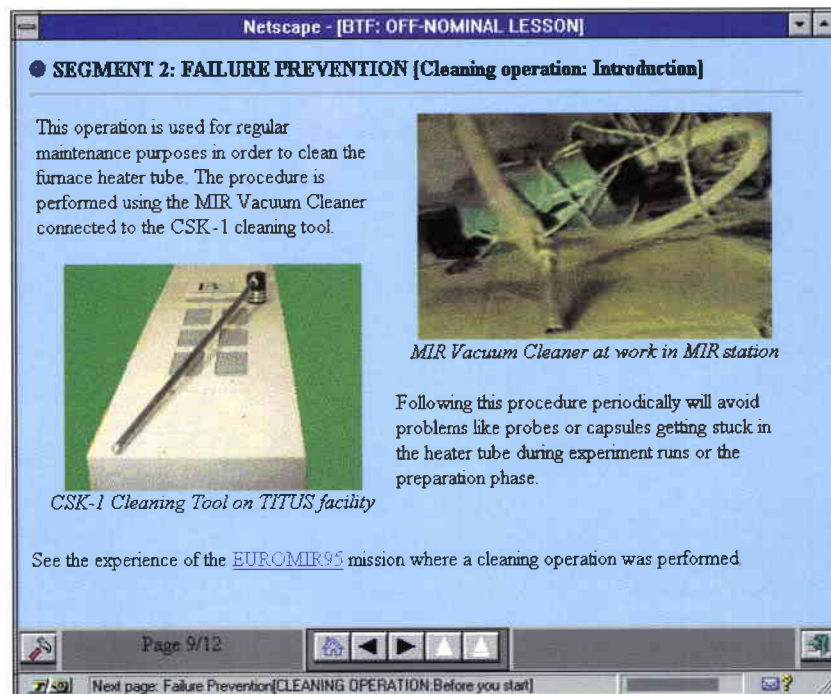

lesson pages, lesson engine, trouble-shooting engine – when requested by Web browsers. In addition, a Web server can receive data coming from a Web browser and process it by executing a server-side application (CGI script).

**4. Web browser (Netscape 3.0)**

This commercial off-the-shelf application requests data from the Web server and processes it when received. Different actions will be performed by the browser based on the nature of the incoming data: a Javascript-based lesson or trouble-shooting engine will be executed; an HTML-based

lesson page will be displayed on the screen; and a facility/control-software emulation session will be started when an emulation script is received.

**5. Facility-control software (TITAN)**

This application provides the user interface for the complete control and monitoring of the TITUS furnace. With TITAN, users can define automated procedures to operate the furnace and subsequently load them in to be executed.

**6. Facility emulator (TITUS furnace emulator)**

This application can be run in stand-alone mode or can be controlled via the facility-control software, whereby the emulator substitutes for the real facility. In addition, both the emulator and the facility-control software can be controlled by scripts launched by both the nominal- and non-nominal-operation courseware.

**7. Scripting Helper Application Engine (SHAPE)**

SHAPE provides the interface between the courseware, facility emulator and the facility-control software. It allows authors to create scripts that can be launched from an HTML link in the courseware and execute the emulator and/or the control software. These scripts can be used to run a simple animation of a procedure in the emulator, or to ask the astronaut to perform a complex task (with guidance and help between each step) using the emulator and/or the control software, allowing the astronauts to continue only when they have performed it correctly.

**Figure 4. MOTE system components**

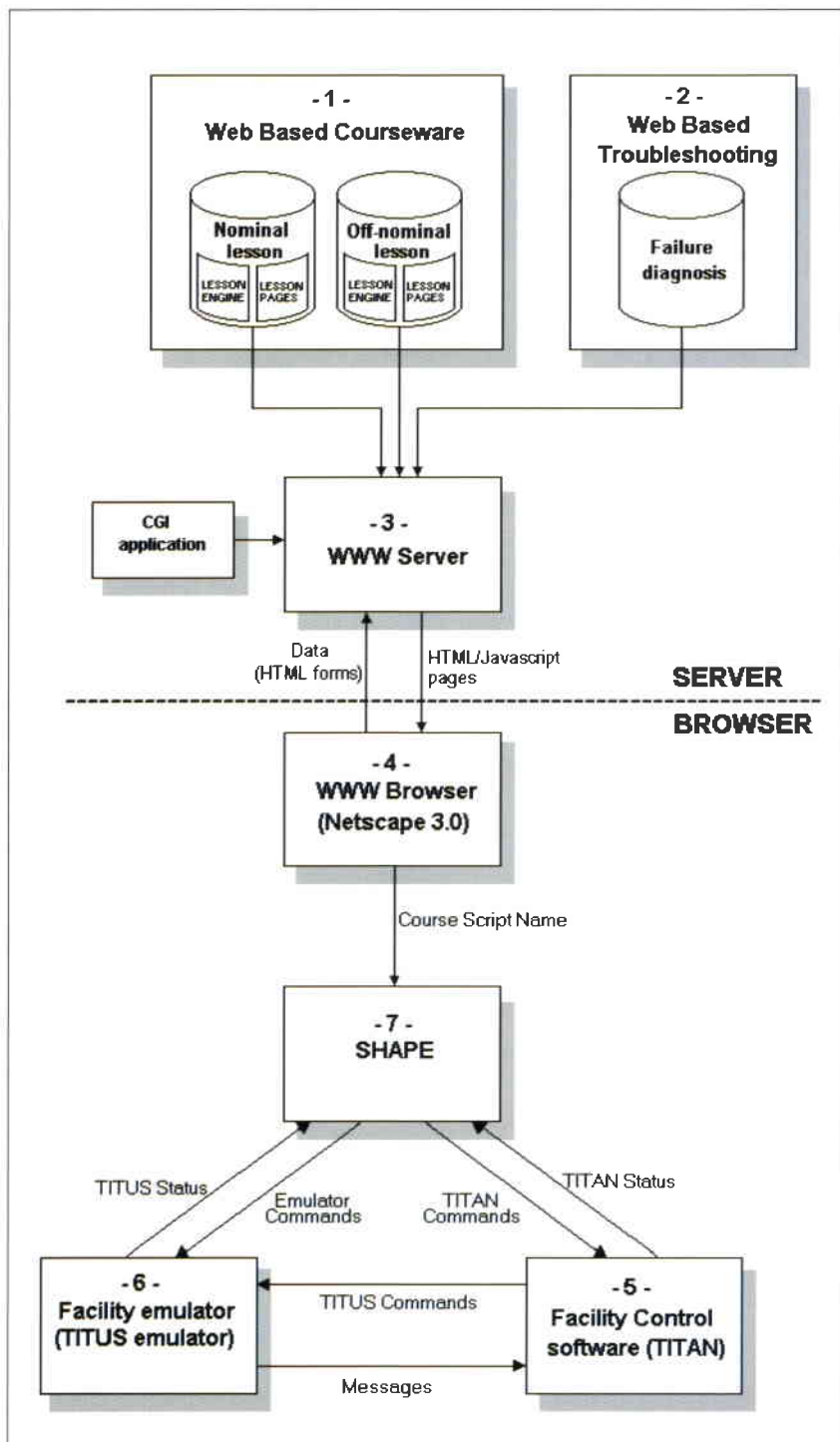

**Web-Based Training**

Computer-Based Training (CBT: training delivered on a computer) is rapidly taking advantage of all of the emerging technologies in the form of Web-Based Training (WBT), an innovative approach in which the WWW is the vehicle for delivering training. An increasing number of organisations, universities and industrial corporations have already chosen WBT to implement their training strategy due to its many advantages, which can be summarised as follows:

**Time- and place-independence**

Users can access the training system whenever and wherever they want. A team of trainees can be brought together from around the globe, and/or instructors can coordinate instruction with colleagues from other locations. All of this provides a new scenario for collaborative training which is difficult to implement using instructional settings other than WBT.

# The World Wide Web (WWW)

The WWW (or Web, for short) is a wide-area client/server architecture for exchanging hypermedia information across the Internet network. In this distributed environment, the information is transferred between Web servers (information providers that store and distribute WWW documents) and Web browsers (client applications such as Netscape™ or Mosaic™ that retrieve and display these data).

Web pages (WWW documents) are formatted in HTML (HyperText Markup Language), which consists of a set of tags to create hypermedia documents i.e. multimedia pages containing text, graphics, sound and video, that include hyperlinks (clickable areas on the screen linking to other documents).

Figure 5 shows an example of the interaction between Web servers and browsers. A user in Computer-A accesses a Web page which is served by Computer-B. The loaded Web page can contain hyperlinks to other pages that may be in the same Web server or anywhere else on the Internet. 'Navigating' through the WWW, information is accessed in a non-linear way, unlike 'traditional' book-like documents where the text must be read sequentially (from top to bottom).

A special feature of the WWW is that it is a heterogeneous, flexible environment; i.e.

- Different available communication protocols can be used to retrieve documents over the network, including: FTP (File Transfer Protocol), SMTP (Simple Mail Transfer Protocol), and HTTP (HyperText Transfer Protocol), the latter being specifically designed for the transmission of WWW documents between Web servers and browsers.
- Platform independence: Several operating systems (UNIX, OS/2, Windows 3.1/95/NT, Macintosh) have their own version of a Web browser. This means that it does not matter which platform is used to generate the HTML documents, or the environment where the Web server resides – the information is equally accessible by a Web browser.

## Evolution of WWW

Since its birth in the late 1980s at CERN (European Centre for Nuclear Research), the WWW has become tremendously popular and has evolved quickly, adopting new technologies along the way. The most significant ones include:

- Helper applications  
A helper application is an external program that can handle a specific type of file (e.g. an MS Word document) that the Web browser is not able to 'understand' by itself. These external applications are not integrated into the Web browser program and therefore require a new window to be opened when launched (data cannot be embedded in the HTML page).

**MOTE uses this feature to run SHAPE as an external (helper) application when an emulation script is received by the Web browser.**

- Plug-in technology  
Like helper applications, plug-in technology extends Web-browser compatibility with new types of data; the difference is that plug-ins are dynamic software modules that are completely integrated into the browser program. A plug-in allows the information to be presented as a part of a larger HTML document (e.g. multi-media animations or videos). Since their introduction, a growing number of independent software developers are creating new plug-ins to make Web browsers compatible with their own applications.
- Server-side processing  
CGI (Common Gateway Interface) technology allows the Web server to process information coming from the browser, dynamically create an HTML page, and send it back to the client, thereby adding more interaction between Web servers and browsers. CGI programs are located on the server side and can be written in several programming languages.

**In MOTE, a CGI Perl script stores information that the browser sends to the server (questionnaire responses).**

- Client-side processing  
Languages like Java or Javascript represent the next logical step in the WWW's evolution. In the past, a Web browser was only able to display incoming information from Web servers (and eventually send information by using forms). With Java, client-side applications are embedded in the HTML document and, once loaded in the Web browser, are executed using the client's own computer processing power. The result is more dynamic and interactive Web pages and optimisation of data transfer between server and client.

**The lesson and trouble-shooting engines used in MOTE make use of this technology.**

- Virtual reality  
VRML (Virtual-Reality Modelling Language) has become the standard language for the representation of three-dimensional virtual worlds within the World Wide Web. With VRML-enabled Web browsers, users can author and view interactive 3D scenes that include text, pictures, animations, sound and video. Moreover, the same world can be 'interacted with' by multiple users located at different sites.

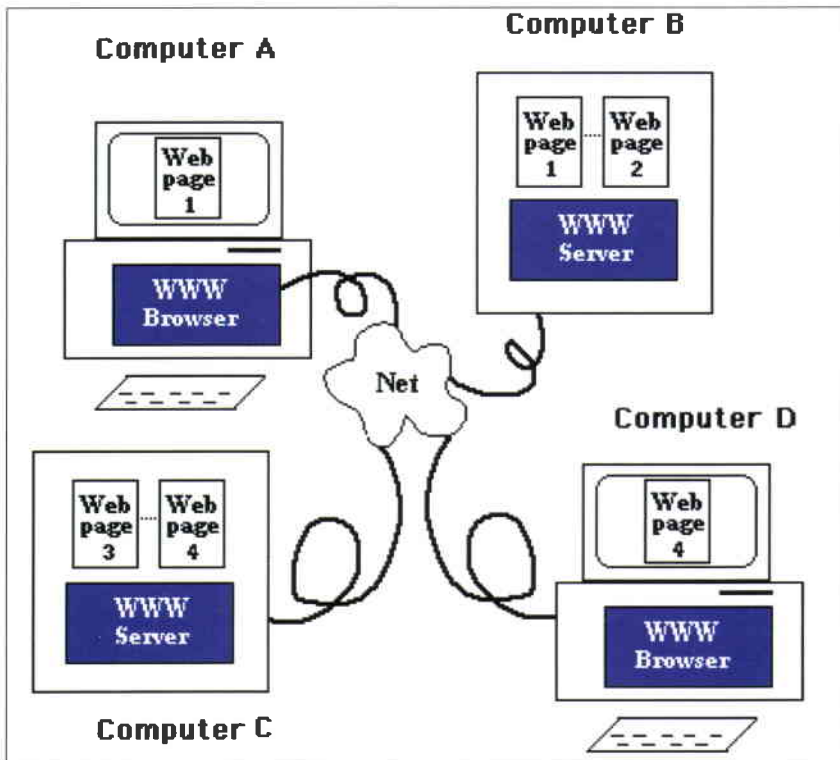

Figure 5. Example of the interaction between Web servers and Web browsers

**Multi-platform capabilities**

The WWW is platform-independent by nature in that the browsers are developed for the different platforms but making use of the same data formats and protocols. Users at different locations can be using different systems (operating systems, computers) without affecting training efficiency and performance.

**Easy updating of instructional material**

Updating Web-based instructional material (Web pages) is easier and quicker – and therefore cheaper – than other kinds of delivery support (e.g. CD-ROM). On-line access minimises redundancy of information, in that the lesson contents are stored on a reduced number of Web servers, and consequently also the effort spent on updating.

Figure 6. Example scenario for WBT

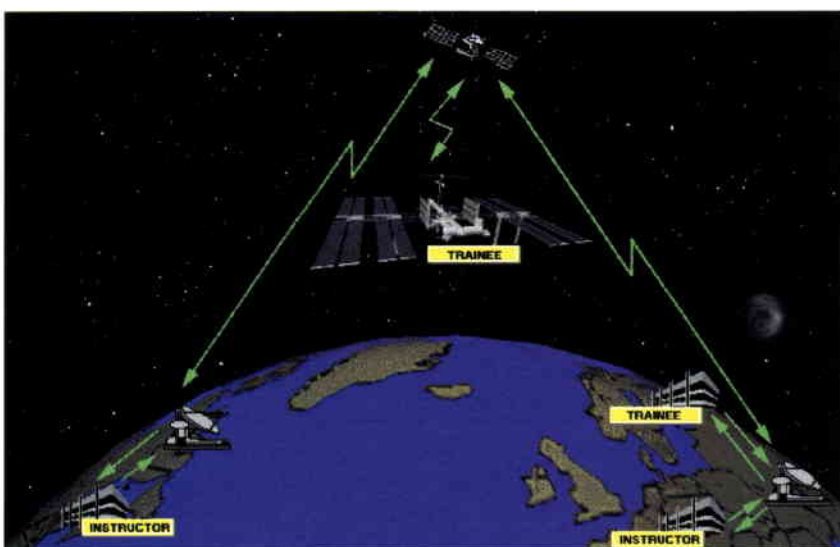

**Interactive environment**

A good application of multi-media and instructional methodologies results in highly interactive user interfaces that enhance training efficiency. A networked environment adds the possibility of interaction between users (instructor – trainee, trainee – trainee, and instructor – instructor).

**Performance control**

Web technologies allow the immediate monitoring of trainees' activity (logging access, training-session performance, test evaluation). This can only increase feedback and improve the quality of training.

**Use of existing tools**

An Internet-based environment such as WBT provides a number of utilities that complement the training activity, including: use of e-mail, BBS (Bulletin Board Systems) or WWW itself to search for additional information, and real-time conferencing (text or video based).

On the other hand, the current state of development of such a new technology also has disadvantages:

**Limited bandwidth**

A growing number of WWW users, the use of memory-intensive data (sound, motion video, sophisticated graphics), and the limited bandwidth of the Internet connections results in slower performance. For this reason, today's Computer-Based Training platforms that require high multi-media capabilities are based on stand-alone platforms and CD-ROM media delivery. Meanwhile WBT developers are combining techniques like data compression, efficient Web page design, and server/client-side programming to cope with this limitation.

Advances in computer network technology and improved bandwidth will result in capabilities for better multi-media access. Already available WWW-based features like 3D virtual reality, animations, conferencing, and real-time audio and video will be powered with these improvements.

In this direction, the Internet-II project (a recent agreement between several US universities, supported by the US government and industry) will be developed to exploit the capacity of broadband networks to support multi-media communications, real-time collaboration, and other functions that can advance distance education. The network is expected to be developed over the next 3 to 5 years.



## Security

Being a worldwide public network, the Internet allows the sharing of information among users distributed around the world. This feature can also be seen as a disadvantage when the information must be protected against misuse and unauthorised access.

The use of Intranets (private networks contained within an enterprise using Internet protocols) is common among organisations which want their information secured against external intruders. Large enterprises allow connection beyond the Intranet to the Internet through firewalls (servers that have the ability to screen messages in both directions so that company security is maintained). Another safety strategy is the use of 'tunnelling' protocols that allow the creation of a secure network through 'tunnels' over the public Internet.

## Poor authoring environments

Today's authoring environments for WBT are currently far less evolved than those provided for multimedia CBT, but this is changing very rapidly. Authoring software for WBT is currently following two approaches:

- The first approach is that followed by companies and research organisations which develop WBT courseware using the WWW as a scenario. They employ WYSIWYG HTML editors (Web-page designers that do not require knowledge of HTML) and client/server programming (i.e. CGI, Java and Javascript applications).
- The second approach is being followed by CBT/multi-media-experienced companies that already have powerful authoring environments. By developing interfaces between these applications and the WWW (using plug-in technology), they solve the problems of authoring and Web delivery concurrently.

We will now move on to analyse some of the special requirements imposed by the new International Space Station (ISS) distributed and on-board training scenarios, and then show how Computer-Based Training, and in particular Web-Based Training, are well-suited to meeting these requirements.

## Training in the ISS era

The International Space Station (ISS) Programme is a joint effort involving five international partners: NASA, RSA, ESA, NASDA and CSA. A primary purpose of the Station is to provide a permanent low Earth orbit research facility with which to perform microgravity experiments in a variety of

disciplines: life sciences, materials science, technology, etc.

During the Station's planned operational lifetime of some 15 years, its on-board science facilities will be used continuously in orbit by scientists and astronauts for long periods of time. It will also be the focus of activity for thousands of researchers across the world who will monitor and operate experiments from the ground.

Thus, the personnel involved in ISS training activities span a wide range of cultures, locations and individuals: astronauts (payload specialists, mission specialists), ground-based scientists and ground support personnel must know how to perform the experiments for a particular mission and be familiar with the on-board and on-ground facilities. The training materials required to achieve this can include simulators and Computer-Based Training that will be used at different locations around the world many times. The multi-national nature of the ISS means that the different individuals involved in training (subject-matter experts, scientists, instructors, astronauts) and the training material can be located in different countries.

WBT appears to be an ideal training instrument in such a distributed environment.

## In-orbit/On-Board Training (OBT)

Once fully operational, the ISS will host from three to six people at a time, a typical astronaut mission lasting from 3 to 5 months in orbit. In this scenario, crew members will combine station maintenance tasks with the development of research activities, and will eventually have to deal with non-nominal situations (due to unexpected experiment results, changing environments or facility malfunctions with different potential hazard levels).

Although most on-board activities will be the subject of pre-flight training, On-Board Training will still play a key role in many cases:

- *Proficiency/refreshers training:* In the context of a long-duration mission, OBT must be applied to maintain astronaut skills in terms of theoretical/practical knowledge of systems and payloads, immediate/automated response in emergency situations, and proficiency training for psycho-motor skills for robotics, EVA and time-critical tasks.
- *Non-nominal situations and malfunctions:* Training is needed for activities not easily practised on the ground in normal gravity, such as emergency egress (fire,

- contamination), hatch opening/closing, or moving large masses during IVA/EVA.
- *Just-in-time training*: This covers tasks requiring little or no previous training and/or knowledge. Here, most objectives can be accomplished with training just prior to or during the execution of a given task. This approach will be targeted primarily at low-criticality, low-complexity, non-safety-related, and unforeseen in-orbit tasks.
  - *Handover training*: Task-specific training will be required for shift or flight-crew handovers.

#### **On-Board Training applying WBT**

WBT is especially well-suited for implementing certain types of on-board training – proficiency training, refresher training, training on non-nominal situations and malfunctions – benefiting from both CBT and Web technologies. To justify this claim, we must address key requirements that the ISS framework will present:

##### **Req. 1: Flexibility (easy updating of training and reference material)**

The available computer-based material developed to train ISS crew members will evolve continuously as more experience is gained in the use of the Station. New lessons (nominal and non-nominal) will be identified and developed continuously and existing lessons will be subject to revision. The same logic can be applied to systems and payload reference information. In a Web-based environment, this updating is immediate.

##### **Req. 2: On-ground/on-board common information**

The sharing of information between ground-based personnel and crew members not only avoids data inconsistencies and facilitates updating, but also improves communication between the different users. Assistance during training is optimised when both the instructor and the trainees have exactly the same information on the screen. The same situation occurs when using any kind of software application that may require supervision or support from a remote expert.

##### **Req. 3: On-ground/on-board common user interface**

OBT is best achieved when the trainee is already familiar with the training environment. WBT has been presented in this context as a suitable element with which to train ISS on-ground personnel (including astronaut pre-flight training). Its extension to on-board training means that crew members

will not need to adapt to a new training environment.

##### **Req. 4: Access to ground-based scientific information**

Accessing ground-based scientific material and communication with ground-based scientists will be common requirements for ISS crew members. The WWW provides an integrated environment in which the worldwide scientific community can communicate and share information (e-mail, file transfer, Web access).

##### **Req. 5: Integration of training with on-board operational environment**

WWW applications are already present on millions of computer desktops distributed around the world. The computer industry is evolving very quickly towards an integrated platform where all software applications are structured on a WWW foundation. Training and operational support tools are no exception and their level of integration with the WWW will increase in the coming years.

##### **Req. 6: Platform independence**

The worldwide community that is contributing (and will contribute) to the ISS project is a very heterogeneous one. Taking advantage of its inherent multi-platform capabilities, the WWW allows users to design, develop and deliver training regardless of the operating system or computer used.

##### **Req. 7: High level of security**

The operationally controlled environment of a Space Station requires a high level of access and security control that MUST be enforced. A great deal of effort has to be devoted in order to foresee controlled, monitored updating of onboard electronic information. Whilst this implies an additional effort in the development phase, it will guarantee that information exchanges with the Station are free from the hazards of unforeseen and unplanned communication.

Web-Based Training, despite its current limitations (Internet's limited bandwidth presently being the most prevalent), meets the requirements presented above, making it a very valuable candidate for both ISS on-ground and on-board training.

##### **Mir 97 on-board experiment: a WBT test case**

One of the European Astronauts Centre's contributions to the Mir 97 mission is an on-board training experiment consisting of a non-nominal-operations lesson and a trouble-shooting tool, as mentioned earlier in this article. The goals that led to the

development of this experiment were:

- the validation of CBT as a suitable tool for supporting astronauts during long-duration missions
- the validation of the ability of computer-based tools to provide operational support to astronauts in non-nominal situations
- the testing of these capabilities on a manned spaceflight mission in preparation for the International Space Station
- the promotion of the World Wide Web as a tool for delivering on-board CBT for manned spaceflight
- the promotion of the use of integrated training environments where facility emulators are used, together with nominal- and non-nominal-operation courseware and failure-diagnosis tools.

### Experiment execution

The software will be uploaded to Mir via Soyuz TM-25 at the start of the Mir 97 mission. The experiment itself is scheduled for flight day 10 and has five phases divided over two sessions: an on-board session comprising failure presentation, failure identification, presentation of failure solution and questionnaire, and a later post-flight session:

- *Phase 1: Failure presentation (on-board, approx. 10 min)*

The astronaut is confronted for the first time with a non-nominal situation which involves a TITUS furnace failure. The scenario is presented in the form of a description and does not involve the real facility.

- *Phase 2: Failure identification (on-board, approx. 15 min)*

A trouble-shooting session is started in which the astronaut can look for symptoms presented in a structured list, select the ones matching the failure and request a diagnosis. The system will provide a list of failure estimations (sorted by probability) with possible causes, required actions and reference material. One of the elements available in the reference material is in fact a link to a non-nominal-situation lesson that provides all information necessary to cope with the failure.

- *Phase 3: Presentation of failure solution (on-board, approx. 25 min)*

A non-nominal lesson starts loading the lesson engine, which provides the lesson user interface and contains the lesson structure. Using the navigation bar and lesson hyperlinks, the user will access the instructional material in order to understand what caused the failure, how to solve it and how to avoid it in the future.

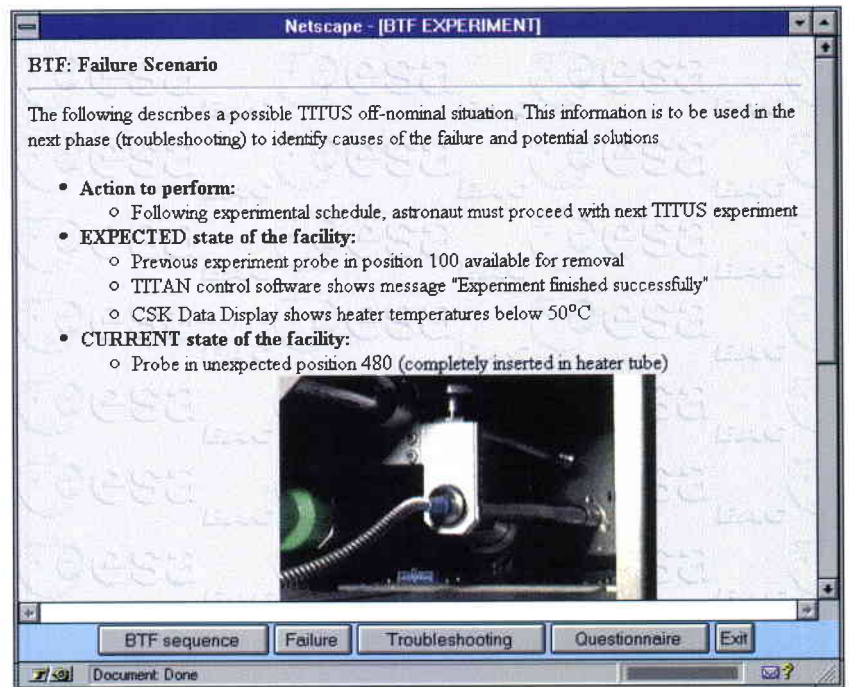

- *Phase 4: Experiment questionnaire (on-board, approx. 10 min)*

The astronaut is asked to complete a questionnaire about the experiment itself (trouble-shooting tool, lesson layout, navigation concept).

- *Phase 5: Post-flight session*

The astronaut performs the non-nominal procedure to solve the problem (the ground-engineering model of TITUS facility is used here) and provides more detailed feedback about the overall failure-recovery environment.

**Figure 7. Failure presentation**

**Figure 8. Trouble-shooting session**

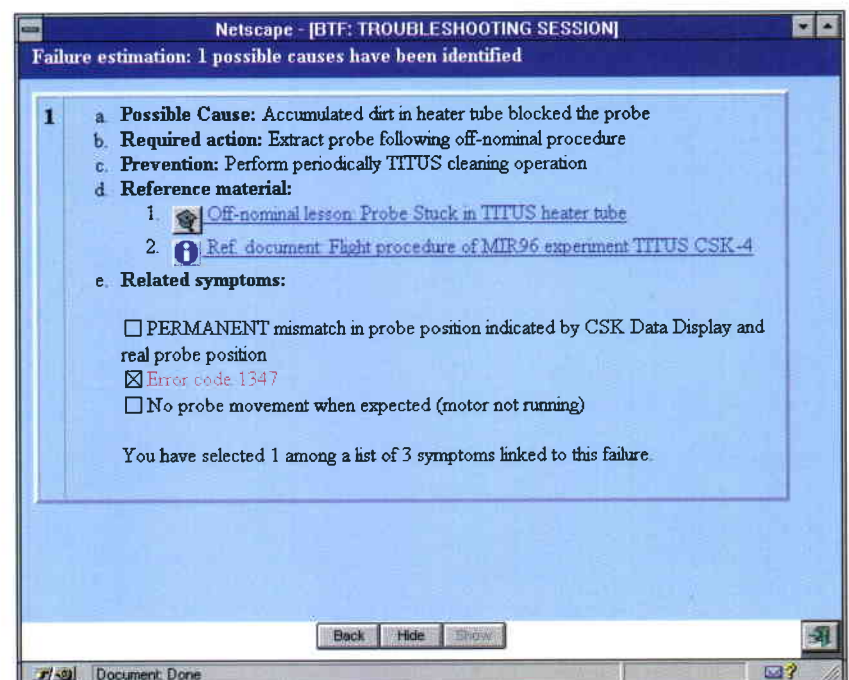

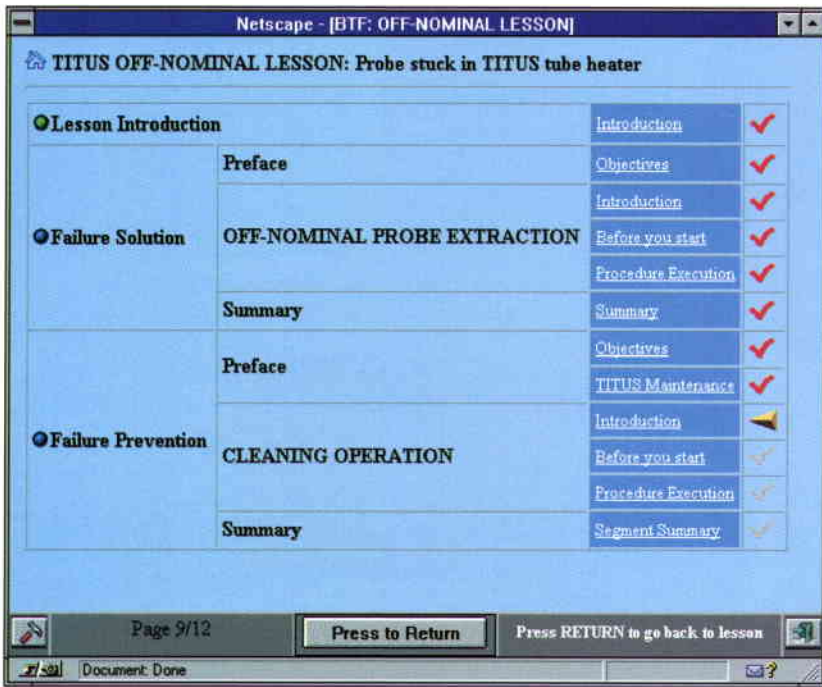
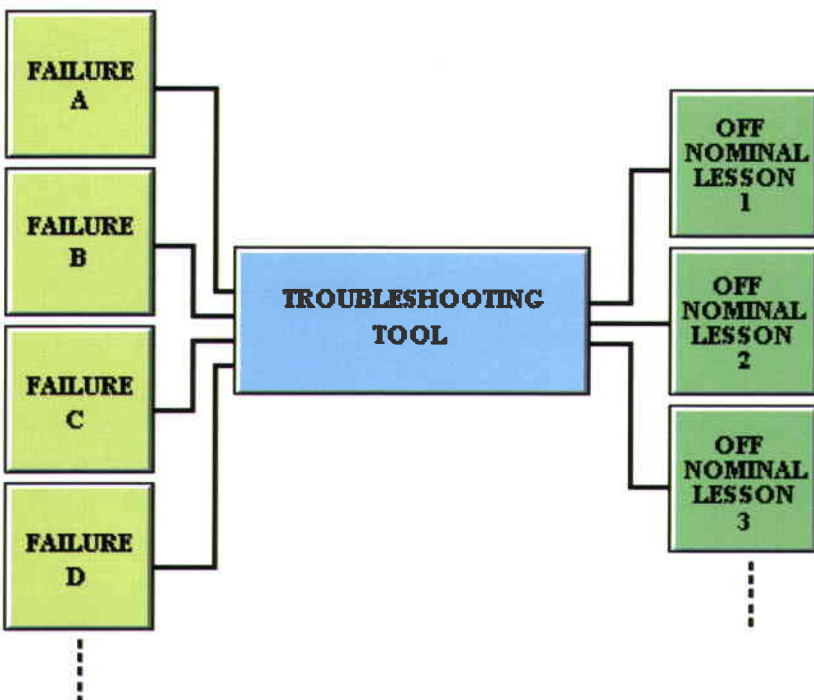

Figure 9. Non-nominal-operation lesson (table of contents)

**Main experiment features**  
*Web-Based Training*

The information used in the experiment is provided by a Web server and accessed and displayed by a Web browser. All the elements have been developed using Web technologies (HTML, Javascript, CGI). However, in the on-board environment, the experiment itself is not integrated on a computer network (server and browser are in the same machine) because of the station's limited resources in terms of available computers and ground connections.

Figure 10. Experiment architecture  
N failures, 1 trouble-shoot, and M lessons



*Modularity*

The main elements of the experiment (failure presentation, trouble-shooting and non-nominal lesson) are completely independent modules that are interconnected. The system can grow, adding new failure scenarios, and non-nominal lessons will trouble-shoot the connection between them.

*Computer-Based Training standards*

The non-nominal-situation lessons (two have been developed for the experiment) are designed in a modular fashion, with the instructional material (lesson pages) independent from the 'lesson engine' (lesson layout, navigation mechanism, tools), thereby facilitating updating and the creation of new lessons. The design of the lesson user interface and the lesson structure is based in current CBT guidelines (NASA standards) that have been carefully reviewed and adapted.

**Experiment development**

*Web browsers/servers employed*

The experiment is based on the popular Web browser from Netscape™, taking advantage of the new features included in its latest version (3.0, released in August 1996 and available on 16 different platforms). On the server side, the EMWAC (European Microsoft Windows NT Academic Centre) HTTP server provides all of the information requested by the browser. The experiment has been developed in a networked environment and successfully tested using Netscape 3.0 for the following three platforms: Windows 3.1/95/NT, Macintosh and UNIX.

*Trouble-shooting implementation*

The 'trouble-shooting engine' is a piece of software completely programmed in Javascript (object-based scripting language embedded in a HTML page), and takes advantage of the new features present in its latest version (included in Netscape 3.0). It performs the following tasks:

- definition of all data structures (tables) with failures, symptoms, estimations and relations between them
- provision of a user interface to allow trouble-shooting (display/selection of failure symptoms and failure estimations)
- diagnosis of possible failures based on user-selected symptoms and presentation of failure estimations sorted by probability (this is done by scanning the relational symptom-failures tables)
- generation of HTML pages 'on-the-fly' that contain hyperlinks to non-nominal lessons and/or reference material (e.g. 'Mir 97 flight procedure for TITUS facility').

### Non-nominal lesson implementation

As previously mentioned, the non-nominal lesson is based on two modules: the instructional material (lesson pages) and the lesson engine:

- the lesson pages are formatted in HTML version 3.0 and make extensive use of Netscape™ frames (a recent extension of HTML that makes it possible to divide Web pages into multiple, independent, scrollable regions); to create these pages, the 'HTML Assistant Pro 2' authoring tool has been used
- the lesson engine, like the trouble-shooting engine, has been programmed using Javascript; it provides contextual information to guide the user during the course of a training session.

### Future improvements

The implementation of an interface between engines and external databases will increase modularity and flexibility, allowing the trouble-shooting engine to be independent of actual symptoms, failures and estimations, and the lesson engine to be independent of lesson structure and content. It will also allow the dynamic updating of trouble-shooting and lesson elements by different users.

New elements can be added to the lesson engine to improve lesson layouts and hence training efficiency, e.g. a graphical representation of the overall lesson and the trainee's position therein at any given time.

The trouble-shooting engine can be improved by the inclusion of more 'intelligent' diagnosis methodologies (e.g. use of neural-network technology, assigning dynamic weights to symptoms or groups of symptoms when related to different failures and assigning thresholds to estimations that will only be activated when a given number of associated symptoms are selected).

Tutor support and communication between users can be upgraded by the inclusion of a type of Bulletin Board System (BBS) in the lesson environment to allow users to exchange messages at any time.

The development of an authoring environment that allows one to easily define and include new lessons and non-nominal scenarios will complement the lesson/trouble-shooting engines, allowing the system to grow with contributions from different lesson authors.

### Conclusion

Web-Based Training is an emerging multi-media, distributed, interactive, platform-

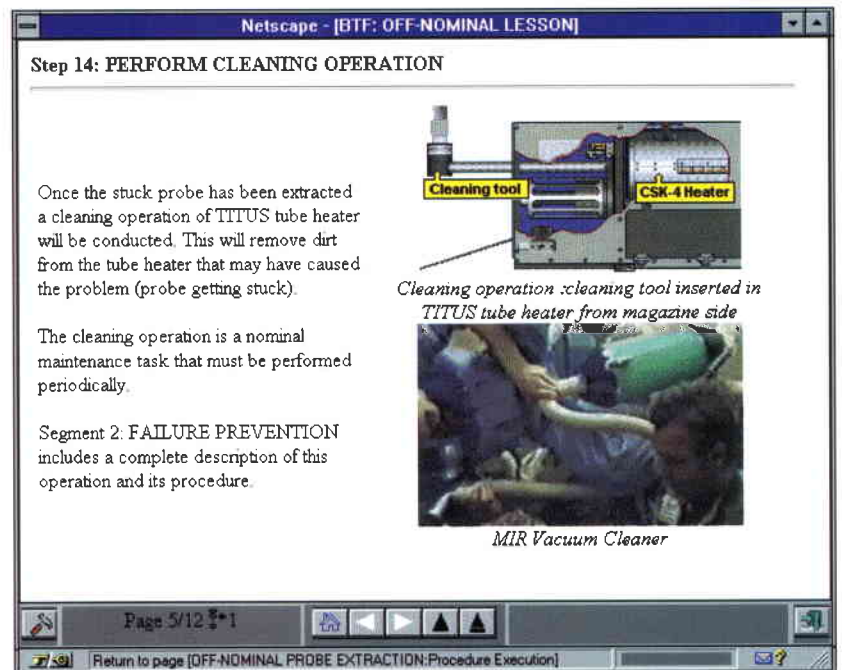
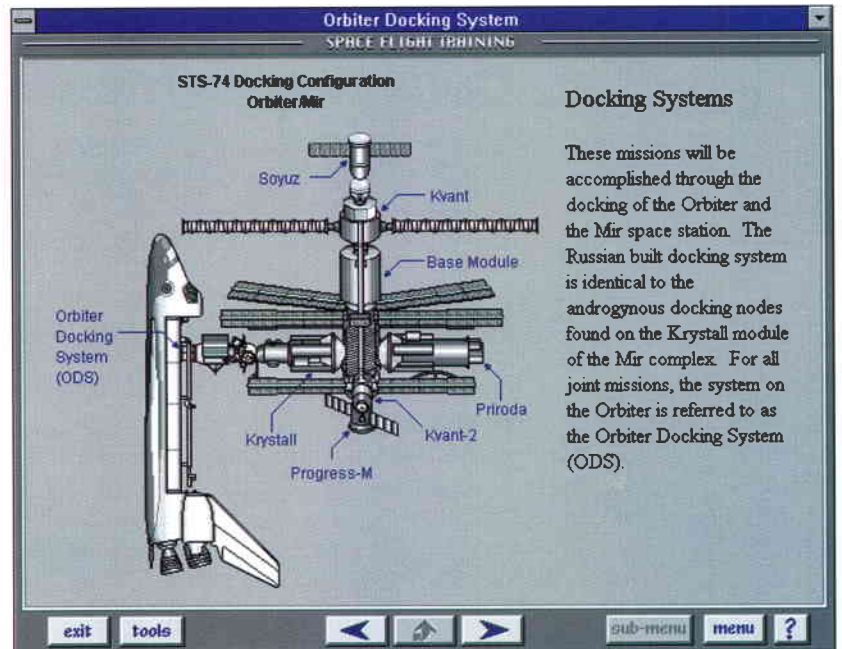

independent technology for the preparation, delivery and implementation of training in a distributed and heterogeneous environment.

In this article, we have shown how Web technologies can be applied to a Space Station on-board facility to provide an integrated operational support environment that the astronauts and ground personnel can use cooperatively to cope effectively and efficiently with both nominal and non-nominal mission situations.

### Acknowledgement

The authors would like to thank A. Pidgeon, R. Henderson and W. Peeters for their kind support during the preparation of this article. ©

Figures 11a,b. A NASA CBT lesson page and an EAC experiment lesson page

# Serving the Earth-Observation Community: The CEOS Dossier

## L. Fusco

ESA Remote Sensing Department, ESRIN, Frascati, Italy

## S.G. Ansari

ESA Informatics Department, ESRIN, Frascati, Italy

## B. Bizzarri

Scientific Adviser to the EUMETSAT Director, Rome, Italy

### Introduction

One of the most visible outputs of CEOS activities in the last years has been the production and publication of the so-called 'CEOS Dossiers'. Produced on paper and distributed to all CEOS members, the aim has been to set out CEOS's current and future plans and their relevance to user needs (particularly those of the CEOS Affiliate representing the users).

---

**Set up during 1996, the CEOS Database on User Requirements and Space Capabilities was implemented to serve, in the first instance, the Task Force for Planning and Analysis, which was created under the auspices of the Committee for Earth Observation Satellites (CEOS). Its purpose was to analyse user requirements and assess to which extent current and planned Earth observing systems from space can meet them. The database is now available to support further CEOS initiatives and the Earth-observation community.**

---

The task of updating the Dossier Volume A (Satellites, Missions) and Volume B (Affiliate Requirements), both dated September 1994, has been considered a high-priority activity. This was a prerequisite in enabling the CEOS Plenary Task Force on Planning and Analysis, chaired by Bizzarro Bizzarri, to analyse whether available instruments can meet the requirements of the user community well into the next decade.

ESA initiated the CEOS Dossier Project in 1996 to implement a database on user requirements and space capabilities that would allow the Task Force members to share and update information on-line.

### The system objectives

The implementation of the CEOS Dossiers on-line database falls under the responsibility of the team handling the CEOS InfoSys at

ESRIN. The initial objectives have been to:

- complete the information for Satellite Mission and Instrument capabilities as expressed by space agencies
- complete the information for the Affiliate Member user requirements as expressed by the CEOS Affiliates
- provide the CEOS Task Force with a working environment which includes a set of functions allowing it to carry out its tasks under restricted database access
- publish an updated version of the CEOS Dossier on a periodic basis.

In particular, it has been important to provide an overall system to the Task Force in order to share the maintenance of the on-line information and to facilitate the authorisation of its validity prior to its publication.

### The system features

Based on the ORACLE Database Management System, the CEOS Dossier is a World Wide Web interface with an access-control mechanism. Each member has a user name and password that allows:

- access to the contents of the database
- hyperlinks to external information leading to a better integration of available resources
- online updating of all the information stored
- graphical display of two- and three-dimensional plots
- export of analysis tables to a spreadsheet.

The completeness of information is based on a five-level structure introduced and agreed upon by the Task Force and maintained by each CEOS space agency (Figure 1):

- *Level 1*: agency description and directory of agency's satellite/instrument programmes
- *Level 2*: programmatic features of satellites (and satellite series)

- Level 3: satellite description (orbit, communication and instrumentation information)
- Level 4: instrument description (measurement objectives, spectral characteristics, general and operational features)
- Level 5: instrument performance in terms of geophysical parameters.

The Affiliate programmes' user requirements are organised in terms of parameters as a function of applications. At present about 50 applications are stored covering the Affiliates: WMO, WCRP, GCOS, IOC, IGBP, ICSU, UNFP, UNOOSA, and the European Commission programmes, using over 90 geophysical parameters (e.g. temperature profile, sea-surface temperature). Requirements and instrument performances for each of these parameters are expressed in terms of horizontal and vertical resolution, accuracy, observing cycle, delay in availability, and confidence level.

**Visualisation and export tools**

The CEOS Dossier has several powerful features. It not only allows updates to be made on-line, but also permits basic analyses of application requirements. This is facilitated by the introduction of a graphical package directly interfaced to the database, which displays two- and three-dimensional plots (Figure 2). The user may choose to plot from a list of geophysical parameters, for any combination of horizontal and vertical resolution, accuracy, observing cycle, and delay availability.

**Next step**

The CEOS Dossier development was completed in November 1996 and was demonstrated at the CEOS 10th Plenary Session, on 13-15 November 1996, in

LEVEL 1 Agency	ESA (European Space Agency)
LEVEL 2 Satellite programmes Satellite series	ERS Programme
LEVEL 3 Single-satellite programmes Satellites developed in cooperation with a leading Agency	ENVISAT-1 MSG-1 (with EUMETSAT) METOP-1 (with EUMETSAT)
<b>Instrument programmes</b>	
LEVEL 4 Instruments flown on satellites of another Agency	SEVIRI (on MSG-1) GERB (on MSG-1) GRASS (on METOP-1) GOME-2 (on METOP-1) ASCAT (on METOP-1)
LEVEL 5 Instruments not yet allocated to a specific satellite	ALADIN ATLID PRISM MIMR Rain Radar Cloud Radar MASTER SOPRANO
Instruments developed in cooperation with a leading Agency	

Canberra, Australia. During 1997, the system will go on-line to allow all CEOS Members and Affiliates to update and validate the information that it carries. It is intended to produce a limited paper copy of the Dossier and to make the electronic browser publicly available for the entire Earth-observation community to consult. It is also intended to integrate the information in the Dossier with other Earth-observation information systems – notably CEOS Infosys and CEOS IDN – to increase the added value of the service.

**Figure 1. The ESA entry, based on the five-level structure defined for space agencies**

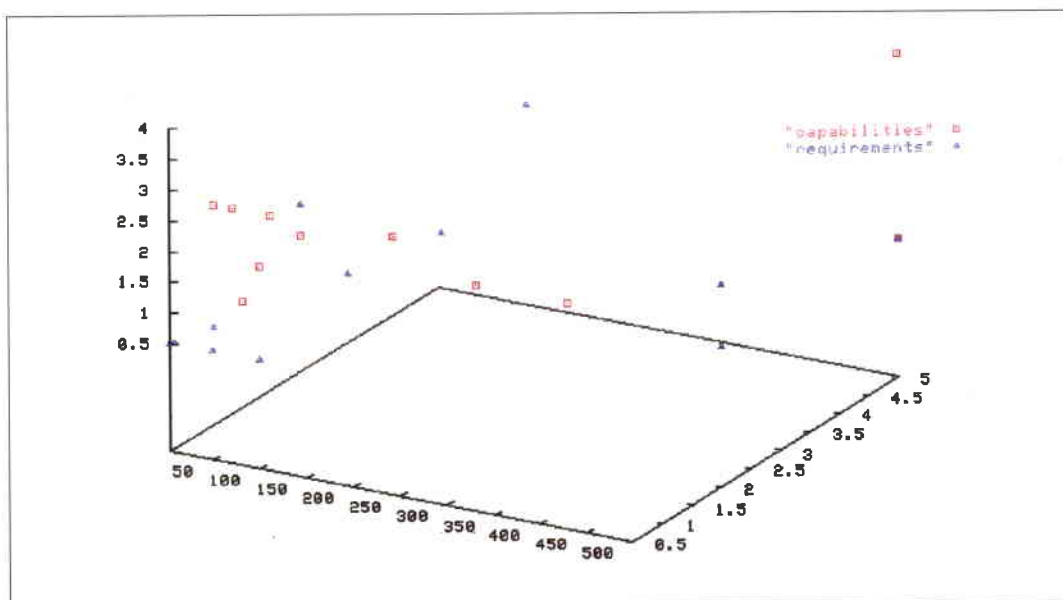

**Figure 2. An example of a two-dimensional plot of Temperature Profile: horizontal and vertical resolution versus accuracy**

# International Cooperation In Space – Developing New Approaches\*

## G. Gibbs

Head of Washington Office, Canadian Space Agency, Washington DC

## I. Pryke

Head of ESA Washington Office, Washington DC

Realising that we are at a unique point in history that offers unique opportunities to exploit space through renewed international cooperation, the International Activities Committee (IAC) of the American Institute for Aeronautics and Astronautics (AIAA), in 1991, initiated the organisation of a series of workshops on International Space Cooperation. To date three such workshops have taken place. The first two, in 1992 and 1994, were held in the USA, exclusively under the auspices of the AIAA. Although each of these workshops, which were by invitation only, included sixty experts from some fifteen countries, the AIAA decided the subject warranted even greater international exposure. Consequently, the third workshop, held in May 1996 at ESRIN in Frascati, Italy, was co-organised with the Confederation of European Aerospace Societies. Preliminary planning for the next workshop, which will be held in Banff, Canada at the end of January 1998, is underway.

The format for all workshops has been similar. The invited participants, drawn primarily from the international space sector, provided viewpoints from government, industry and academia. Participants divided into working groups mandated to address specific topics. The outcome of their deliberations has been documented in workshop reports\*\*, and are centred around a series of findings and recommendations. These workshops have proved themselves to be a valuable forum for reassessing approaches to international space cooperation. They have highlighted what we did right, and wrong, in the past and how we should proceed in the future. As was deduced from the second workshop, international cooperation is now a necessary strategy for achieving many of the goals currently under consideration by the space community.

This article provides a comprehensive assessment of the results of the three workshops held to date and provides some insight into the future direction for international cooperation in space.

\* The authors are co-Chairs of the AIAA-IAC International Space Cooperation Workshops Committee, responsible for the follow-up of past workshops and planning for the next in the series.

\*\* A limited number of the Workshop Reports are available from the AIAA.

To request copies please contact:

Mireille Gerard

AIAA

1801 Alexander Bell Drive, Suite 500

Reston, VA 22091, USA

Fax: (703) 264-7551 — E-mail: [custserv@aiaa.org](mailto:custserv@aiaa.org)

## Introduction

On 21 January 1985, while introducing a Senate Joint Resolution relating to NASA and Cooperative Mars Exploration, Senator Spark Matsunaga stated that:

'At a certain point, anything other than international exploration of the cosmos... will cease to make any sense at all...we must develop policies that respond to the unfolding realities of the Space Age, that move out to meet it on its own uniquely promising terms'.

In the years that followed there was a radical restructuring of the international political landscape, coupled with an explosion of technological capabilities around the world and a growing realisation of the benefits that space technology could provide. This created an environment that was conducive to enhanced international space cooperation.

With this situation in mind, the International Activities Committee of the American Institute of Aeronautics and Astronautics, in the first half of 1991, decided to study the feasibility of organising a workshop on 'guidelines for international co-operation'. The outcome of this study was a go-ahead from the Committee at its January 1992 meeting, for the planning of such a workshop, to be held at the earliest in the September/October 1992 time frame. It was recognised, however, that a single three-day workshop would not be able to cover all aspects and areas of cooperation, or provide all 'solutions'. It was therefore also agreed that this workshop would be the first in a series that would have as its focus 'International Space Co-operation'. As a result of this decision, three workshops have been organised and carried out to date, and a fourth is in the early planning stage.

The first workshop took place in December 1992, in Hawaii, and was entitled *Learning*



from the Past, Planning for the Future. Its primary objective was the development of recommendations, relating to co-operation, in five areas. These were Space Science, Space Exploration, Space Applications, Supporting Infrastructure, and Policies and Approaches (which dealt with cross cutting issues).

The second workshop held in December 1994, again in Hawaii, sought to build on the output of the 1992 workshop event by focusing on the implementation of diverse cooperative endeavours. Its overall theme was *Getting Serious About How*. Working group deliberations were narrowed somewhat in an attempt to determine how, in five specific areas, international cooperation projects might be developed, approved, funded and implemented. The areas, selected for their diversity in technical and political complexity, and varying time scales were, Global Space Systems Services, International Cooperation for Peacekeeping, Cooperative Human and Robotic Exploration of Space, International Cooperation in Space Transportation and Solar Power to Earth.

As planning for the third workshop began, it was decided that inkeeping with the international nature of the activity, international co-sponsorship and a non-USA venue would be sought. This resulted in the workshop being jointly sponsored and organised by the AIAA and the Confederation of European Aerospace Societies and being held in May 1996 at ESA's ESRIN facility in Italy. This time the theme was *From Recommendations to Action*, heavy emphasis being placed on the planning of specific, cooperative, near-term activities. Its working groups had mandates that required them to focus on specific international cooperation objectives and determine the political, managerial and financial processes by which they could best be accomplished.

As the first in a planned series, Workshop 1 was a learning experience for the IAC, not only in terms of the findings and recommendations developed by the individual working groups, but in terms of workshop organisation itself. The overall format of dividing participants into working groups to address specific topics, while providing plenary sessions at which everyone could observe and comment on each other's activities, worked well and has been adopted, with minor modifications, in subsequent workshops. The achievement of consensus within working groups, while desirable, is not a requirement, alternative viewpoints on a specific topic offering useful insights on the issues being addressed. Groups are not required to produce reports

following a rigid common format, thereby increasing the potential for creative thought.

Attendance is by invitation only and has involved, in each case, around sixty experts drawn primarily from the space sector. Participants at each workshop have come from more than a dozen countries and have represented various elements of government, industry and academia.

The results of the workshop deliberations have been developed into a series of reports that have been disseminated worldwide. The 'target audience' has included government decision makers, senior industry and space-agency officials, and other individuals involved in the development of space policy and the implementation of space-related projects.

We will attempt below to summarise the results of each workshop and to discuss, where appropriate, the broader implications of the insights generated as regards the future direction(s) of international cooperation in space. In an article of this length, it is not possible to discuss all of the findings and recommendations developed by each working group. We have therefore selected just a few of the more important ones for review here. Readers are invited to obtain copies of the workshop reports in order to review the working-group deliberations in more detail in areas they find interesting.

### **Workshop 1: Learning from the Past, Planning for the Future**

The overall objective of the first workshop was to develop recommendations for future international space cooperation based, in part, on past experience. Five working groups were established representing major areas of space activity. The key 'findings' and 'recommendations' of each group are summarised below.

#### **Space Science**

*The 'success story' of international cooperation in space is exemplified by space science.*

Space scientists are working in virtually all countries of the world, regardless of the existence or size of space organisations in those nations, and have been involved in international cooperation at all levels. This fact, combined with a common set of goals and objectives, and the modular, incremental and continuing nature of projects, has led to space science becoming a model for international cooperation.

The working group felt, however, that impediments do exist to the success of future cooperation, particularly due to insufficient communication among potential partners concerning their respective project-selection processes. It was therefore recommended that:

*National space agencies should share information with each other on their processes for selecting and funding prospective space-science projects.*

*The working group felt strongly that no single structure, governing international cooperation in this area, should be imposed. They urged a minimum amount of bureaucracy and a maximum amount of flexibility in approaches to space-science cooperation.*

### Space Applications

*The opportunity to develop international cooperative ventures, in space applications of existing and evolving technology, has never been better.*

There are a variety of space applications that, if developed cooperatively, could benefit all nations, both individually and collectively, particularly the less-developed countries.

*Currently the most promising area for enhanced cooperation between governments is the monitoring of the Earth's environment.*

The global nature of the environmental problem and the economic and social consequences have already received the attention of top-level government officials. However, the international mechanisms necessary to coordinate current satellite-systems utilisation and future systems design, and also the efficient gathering and distribution of data, are lacking.

The working group therefore recommended that:

*To further promote cooperation in Earth environmental monitoring, the Committee on Earth Observation Satellites (CEOS) and its Affiliate Members should encourage the establishment of a public and private sector data-users coordinating mechanism.*

Such a mechanism could be used to provide satellite operators with a unified set of data requirements, developed by users, to help in the design and operation of future Earth-observation systems.

A further important recommendation was that:

*The appropriate existing international mechanisms should be used to explore the expansion of other space-application concepts that have high potential for success and contribute to other global needs.*

Where such mechanisms do not exist, they should be established. Such concepts could include telecommunications, satellite navigation and disaster mitigation.

### Space Exploration

*It is unlikely that, in the near term, any government or group of governments will undertake large, costly, long-term space-exploration projects, involving a human return to the Moon or a human expedition to Mars.*

This fact had been demonstrated by the failure of the US Space Exploration Initiative to garner the necessary political, budgetary and public support.

Furthermore, given budgetary pressures worldwide, it was considered unlikely that any such large-scale human exploration effort would be undertaken, in the future, on anything but an international basis. However, the world's space-faring nations had not identified a common goal for space exploration and had limited experience in joint efforts of this kind.

The group therefore recommended that:

*Heads of space agencies of space-faring nations should establish a common international 'cooperative strategy' for space exploration, and continue the dialogue on potential robotic and human exploration projects.*

The group was also of the opinion that when such projects are implemented in the future, they must be truly international with each partner being given the opportunity to contribute elements critical to mission success.

### Space Infrastructure

*The world's space infrastructure resources are not being optimally utilised.*

Despite the abundance of satellite capabilities and supporting space infrastructure around the world, the group considered that there had been insufficient attempt to take advantage of this tremendous worldwide investment made by many nations, though there had been some notable exceptions such as the Halley's Comet

spacecraft armada. Major future space missions, such as a return to the Moon by humans, might be enhanced or their cost reduced if there is international cooperation on the required infrastructure. There was no coordinated, multinational mechanism in place to ensure the optimum utilisation of the world's space infrastructure resources as a means of addressing current and future global challenges.

The group therefore recommended that:

*Space-faring nations work to establish an international mechanism to review the current capabilities of existing and planned space systems.*

The said nations should also:

*Recommend ways to work together cooperatively, where possible, to establish and maintain the space infrastructure necessary to achieve mutual long-term mission objectives.*

## Policies and Approaches

*The development and implementation of international space policy needs to be elevated to a higher level of political attention.*

*Cooperation in space science, space applications and space exploration can serve as a powerful counterbalance to the forces dividing the peoples of the world. A higher political visibility would enhance the significance of space in strengthening relationships among nations, as well as provide the political underpinning for a strong vibrant space agenda for global space projects in the twenty-first century.*

The working group therefore recommended that:

*The policy advisors and heads of space agencies of space-faring nations should stress the value of international space cooperation in support of domestic, economic and political objectives, to their heads of government.*

They, the advisors and agency heads, should recommend that their government heads work towards lessening and eventually removing the most serious impediments to international space cooperation. In addition, a dialogue should be engaged towards establishing common policies and strategies for implementing cooperative objectives. These actions should be taken in the context of assessing policy in sensitive areas, including

licensing, technology transfer, general commerce and trade issues, and adding international space cooperation as a specific focus to their agenda.

The group also considered that:

*Continuing the 'business-as-usual' approach to international space cooperation will hinder the efficient attainment of space applications or exploration objectives, will cost individual nations more than necessary, and will delay achievement of essential missions of benefit to everyone.*

'Business-as-usual' in international cooperation can be described as:

- (i) the lack of common goals, focus, coordination, and integrated planning
- (ii) level or declining space budgets, and
- (iii) mostly national or bilateral projects subject to the leadership initiative of a single country.

They, the working group, specifically recommended that:

*Existing forums on international space cooperation, such as the United Nations Committee on the Peaceful Uses of Outer Space and the Space Agency Forum, should explore how their roles could be enhanced to address international space-project selection and coordination deficiencies identified in the workshop report.*

If existing forums were to prove to be inadequate for this purpose, the creation of a World Space Conference or an international inter-agency coordinating group, as an augmentation to existing forums, could be considered.

## Workshop 2: Getting Serious About How

While the first workshop focused on broad approaches to international cooperation in space activities, the second focused on 'how' to implement certain cooperative endeavours. These were chosen because collectively they covered the spectrum of space cooperation in terms of political or technical complexity and time frame. The following paragraphs outline the key results of the deliberations of each of the working groups.

### Global Space Systems Services

*Today the need for global space systems services in telecommunications, remote sensing, and navigation is growing. These services are becoming accessible to all nations*

*and are increasingly commercial and international.*

The working group addressed the question of whether these services were being fully utilised in a global public-service context and, if not, how they could be used. It is evident these could, in addition to their private-sector service, provide a public service by supporting public safety, disaster warning and relief, peace-keeping, search and rescue, telemedicine and education services.

The working group recognised that many of these services have been made available, through private investment, for commercial purposes. However, these systems are not operating to their full commercial potential because of less than optimum orbital slots and frequency-spectra allocations. Working group members suggested that a trade-off was possible. For example, a condition for more optimum allocations (licensing criteria) could be a requirement to provide a 'public service'. The systems are designed, or could be designed, with minimal incremental cost, to provide public services in addition to their primary commercial service.

The working group concluded that professional organisations and public-service entities worldwide should collectively address the questions raised above with regard to determining the public-service needs. Thereafter, appropriate regulatory organisations should be enjoined to review and consider improved orbit and frequency allocations in return for enhanced public service.

#### **International Cooperation for Peacekeeping**

*Peacekeeping operations around the globe, ranging from crisis prevention to crisis monitoring to crisis resolution, are increasingly international. Precedent-setting discussions conducted during the workshop indicate that opportunities may now exist for cooperatively using national space assets for multinational peacekeeping operations in ways that have never been done.*

The subject of International Cooperation for Peacekeeping was the most politically complex of the projects reviewed at the Second AIAA Workshop. In their paper at the 46th International Astronautical Congress, the working group co-Chairs Messrs. Fuhrman and Wild stated that: 'the discussions that took place during this conference (second workshop) were precedent-setting. This conference was the first occasion for

representatives from major space-faring nations to engage in an open and far-ranging dialogue on space cooperation for peacekeeping, covering the broad array of mutual assets that might be involved in cooperation and the breadth of issues that will have to be addressed'. Further, they wrote that they were 'surprised at the scope of issues on which the participants were able to agree'.

The group recommended that:

*The principal providers of military, civil, and commercial space capabilities should establish an international forum to investigate the feasibility of improved use of current and future space systems for peacekeeping operations. The United States and Russia, as two of the key providers of existing space capabilities, should take the initiative to invite the other providers and other users to participate.*

#### **Cooperative Human and Robotic Exploration of Space**

Due to the important role that international cooperation must play in space exploration, and the results of the Space Exploration Working Group during the first workshop, the topic was again addressed during the second workshop. The working group was tasked with reviewing and building on the findings and recommendations from the first workshop.

The working group defined space exploration as human and robotic activity beyond Earth orbit (both low-Earth and geosynchronous), such as exploration of the Moon and Mars. The group concluded it was unlikely that a country or group of countries would, during the next ten to fifteen years, make a commitment to a single, long-term, large-scale space-exploration initiative. So, until such a commitment is possible, exploration is likely to focus on robotic missions rather than on human spaceflight. The working group considered that:

*For the foreseeable future, large-scale, long-duration space exploration initiatives should be addressed as evolutionary in nature, consisting of a series of interlinked, but programmatically independent phases. Each phase must be justifiable on its own merits.*

The group observed that since the maturing of the space programmes in Europe, Japan and elsewhere means that these countries are setting their own long-term space agendas and are not waiting for the space superpowers to take the lead, these agendas should be coordinated. However, the working group found that:

*Coordination of national agendas does not require a single overarching rationale. Different countries will follow their own rationales for engaging in exploration missions.*

In the longer term, human exploration missions beyond low Earth orbit probably will require an integrated, cooperative approach among several nations because of their magnitude. The group, recognising the International Space Station is precedent-setting, postulated that its success or failure will have significant repercussions for future international cooperation in space projects.

### **International Cooperation in Space Transportation**

*Availability of efficient, low-cost, reliable space transportation will play a pivotal role in the successful accomplishment of future space missions.*

The working group concluded that truly low-cost space transportation will most likely only result from market need ('market pull'). It is unlikely that low-cost access to space will become available from the private or public sectors in the expectation that a market will develop ('market push'). As they stated in their report: 'such an investment by industry or government would require a leap of faith, and this is unlikely'.

The advent of Solar Power to Earth (see next section) would provide the required market pull since, to be economic, the construction of the

necessary space infrastructure will require access to space at a cost of between \$100 and \$500 per pound. It is only at the low end of the range that Solar Power to Earth would be competitive with terrestrial energy sources – for as long as they last. No longer considered so fanciful, space tourism may be another 'market pull' for low-cost space transportation.

The working group recognised that the current activity and focus of effort in space transportation is technology development. The group concluded that ways must be found to reduce technology-transfer barriers and encourage international cooperation in the development of space-transportation systems. Additionally, for success, future actions should involve cooperation at three levels, namely: industry – industry, industry – government and government – government. The problems associated with technology transfer, trade issues and national security exist, but these should not be considered as major inhibitors to progress in the single most important requirement to expand our space endeavours – low-cost access to space.

In summary, the working group found that in the current global fiscal environment, it is unlikely any single nation or regional organisation can afford to develop a commercially viable new space transportation system, be it expendable or re-useable; international cooperation on a large scale would be required to develop launchers that provide low-cost access to space.

**Participants in the AIAA/CEAS International Workshop on Space Cooperation held at ESRIN, 26-31 May 1996**



## Solar Power to Earth

*Provision of clean, low-cost energy is an environmental, economic and international imperative.*

*An international body needs to be formed and tasked with responsibility of determining the feasibility of a space-based solution for the collection and distribution of solar power to Earth.*

The modern concept for supplying Earth with abundant clean energy imported from space was first articulated in 1968. Since then, many studies and technology demonstrations have been conducted, principally in France, Russia and Japan, and the results have persuaded many that this concept is the enabler for a sustainable energy future.

Solar Power to Earth is becoming technically feasible, but there is a considerable spread in the projected global needs for energy. Some projections of the Earth's future energy sources indicate that only coal, solar (including wind) and nuclear sources will serve past the middle of the next century. Solar Power to Earth has the potential for solving our energy requirements. Perhaps the most significant inhibitor for Solar Power to Earth is the cost of access to space.

Solar Power to Earth advocates understand the technical, programmatic and social complexities associated with providing this source of energy, and consequently the group recommended:

*A programme of demonstrations and pilot operations is the best way to advance understanding and acceptance. This is particularly true in the area of the safety of the wireless power transmission. Although studies uniformly find no significant biological effects, studies alone are insufficient. Demonstrations and extended pilot operations will be necessary to convince the public that space solar-power systems are both technically feasible and environmentally safe.*

*Governments and industry in all interested countries should support the development of programmes and fundamental technologies for space solar power to Earth.*

### Workshop 3: From Recommendations to Action

For the third workshop, the working groups were presented with more narrowly defined mandates. Three of the four were charged with developing plans for specific projects, while the

fourth dealt with broader issues of international space cooperation. In view of the approach, the working group outputs were not developed in the form of findings and recommendations per-se.

Predictably this workshop produced many practical approaches for the topics under discussion. The key results of the individual working groups are provided in the following paragraphs.

### Criteria for International Space Cooperation

Departing from normal practices of reporting working-group deliberations, this group took a novel approach by developing a 'Handbook for International Space Cooperation'. It is expected that this handbook will be extensively used for testing whether a planned project would lend itself to, or benefit from, international cooperation.

Bilateral and multilateral initiatives have, at one time or another, been established in most space disciplines. However, whether international cooperation is appropriate for specific projects depends on many factors. The handbook describes criteria that can be used by governments and industry to evaluate the utility of international partnerships in a proposed programme. The application of these criteria provides a methodology for the systematic assessment of each potential partner's viewpoint with respect to domestic interests and material benefits of international implementation.

Two groups of criteria were developed to evaluate whether international cooperation should be pursued for cases of government-to-government cooperation, multi-government to multi-industry cooperation, and industry-to-industry cooperation. These are:

#### Group I: National Interests

- Foreign policy
- National constraints
- International treaties and less formal agreements
- Programme scale
- Programme stability
- Programme risk
- Management regime of partnership
- Confidence in partnership.

#### Group II: Material Benefits

- Financial
- Industrial developments
- Access to expanded knowledge and skills base
- Access to benefits of space (products/services/infrastructure)
- Niche capabilities.

The handbook provides a rationale for each of the criteria and describes how to apply it in an evaluation. By running two test cases, the working group confirmed the validity and applicability of the approach developed.

### **Using Space Assets for Disaster Management**

Space assets have historically been developed for a select group of user communities, generally for military or scientific applications. The 1990s have seen this focus broaden to much larger communities, a trend that is likely to increase as new commercial applications are brought into the market.

At present, no mechanism exists to allow efficient and simple access to these resources by the disaster-management community, nor is there any clear articulation of the specific needs of the disaster-management community, which would enable the owners of space assets to develop resources that cater to these needs.

The working group suggested that, to facilitate dialogue between users and service providers, an organisation should be established responsible for researching the disaster-management community's needs and applications of existing assets, and for suggesting new applications. Such an organisation would also allow economies of scale and rationalisation of current space-asset use. Furthermore, the working group postulated that if structured as a value-added service provider, such an organisation could even be a business, marketing services to governmental and non-governmental disaster managers throughout the world.

The working group's report provides a practical action plan to promote the use of space assets for disaster management. It includes the establishment of points-of-contact to promote awareness-related activities and help promote limited pilot projects for testing and learning purposes.

### **International Cooperation for Space Transportation**

The Space Transportation Working Group continued the work started at the second workshop. The group acknowledged the work of the private sector in expanding available launch services and achieving modest reductions in launch costs (or at least holding them steady). However, it is apparent that to achieve an order-of-magnitude reduction in launch costs, multi-national government – industry partnerships and large investments are required.

It was concluded that up to 50% cost reductions are desired by traditional users, and that to cause a dramatic expansion of space activity cost reductions by a factor of ten or more are necessary. Technologies that permit an order-of-magnitude cost reduction are almost in hand, while some technologies that could result in two to three orders-of-magnitude reductions have already been identified.

The Space Transportation Working Group report established a sound rationale for international cooperation to aid in achieving the required cost reductions. Also, the group established the need and framework, as well as the pre-conditions, for such international cooperation. The most significant pre-conditions were identified as:

- The terms of multilateral cooperation should support industrial, national and regional policies for independent access to space.
- Successful multilateral cooperation in government-supported programmes can be enhanced by striving for equal status among stakeholders, with effective representation in the decision process and without assertions to pre-eminence.
- Multinational cooperation must allow partners to pursue their national economic policies, e.g. market competitiveness.
- National policies to encourage commercial international cooperation and technology-sharing as a means to enable further reduction of the cost of access to space.

To achieve these pre-conditions and to align participants for a significant increase in international cooperation with the objective of achieving low-cost access to space, the involved governments must review the appropriate elements of their respective policies and take appropriate actions. The recommended actions are as follows:

- Move from a focus on bilateral agreements which restrict market freedom to multilateral agreements which facilitate a free market, with a goal of no agreements restricting a free market.
- Implement the Missile Technology Control Regime Agreement in a way which achieves both non-proliferation goals and encourages a free market.
- Eliminate overly restrictive barriers to the exchange of data necessary to facilitate international cooperation, for example through pre-approved protocols.

It is clear that the opportunities for international cooperation in space transportation, especially with an initial priority of technology development for advanced or alternative

technologies, are enormous and the payoff for all involved will be great.

### International Space Station Utilisation Strategy

The successful implementation of the International Space Station, as the largest science and technology project in history, will deeply influence all future internationally cooperative projects. It is of crucial importance, therefore, that the immense capabilities of the Space Station be utilised to the fullest, not only by scientists, but also engineers and entrepreneurs worldwide.

It is not far-fetched to consider the Station as the first concerted step towards making space a common working place and future home for many humans, leading even to colonisation – within current lifetimes – of the Moon and Mars.

However, the range of opportunities offered by the Space Station must be broadcast much more widely to the individuals, institutions and private-sector organisations who could contribute to, and benefit from, the Station's unique environment of microgravity, extremely low vacuum conditions, and orbit permitting unequalled vision and measurements of the Earth, the Solar System and the cosmos.

To help ensure maximum use of the Space Station, the Space Station Utilisation Working Group recommended that the Space Station Partners establish a:

- Multi-National Space Station Utilisation Promotion Initiative (office), staffed by a small group of experienced professionals, with the objective of augmenting the individual efforts of the Partners in:
  - promoting and coordinating Space Station utilisation
  - broadening the scope of scientific and technology disciplines represented
  - seeking and encouraging private-sector investments in entrepreneurial ventures.

Also, the working group recommended that:

- Steps be taken by the Space Station Partners to encourage and facilitate entrepreneurial ventures that provide privately-funded facilities or services supporting Space Station use and growth.

### Conclusion

In this paper, we have endeavoured to provide an overview of the results of the three workshops held to date. Any single workshop cannot, however, be considered a success if its only result is the publication of a report or the identification of the need for a further

workshop. (To quote from the first workshop report: 'The workshop was not an end in itself, merely the initiation of a process of new thinking concerning where we have been and where we are going on international space cooperation').

Fortunately, as regards the current series, this is not the case. Workshop activities have resulted in on-going initiatives being established in a number of areas relating to international space cooperation. To highlight three examples:

- The recommendation of the Space Applications Working Group of Workshop 1 concerning 'the establishment of a public- and private-sector data users coordinating mechanism' is being implemented under the guidance of certain members of the Committee on Earth Observation Satellites (CEOS).
- When the US and Russian governments initiated a dialogue on the potential for cooperation in the military space arena, the initiative and the contribution of Workshop 2's Working Group on International Co-operation for Peace-keeping was acknowledged as having provided a valuable impetus to the activity.
- Workshop 3, which took place earlier last year, has already resulted in:
  - the publication of a 'Handbook for International Space Cooperation', which was produced by the working group that addressed 'Criteria for International Space Cooperation', and
  - the establishment of a coordinated effort by 'points of contact' involved in the implementation of the initial phases of the plan developed by the working group on Using Space Assets for Disaster Management.

Immediately after the second workshop, the AIAA-IAC established a Follow-On Action Committee (FOAC) tasked with promotion and, where practical, the implementation of the output from the workshops and the planning of the next workshop in the series.

Planning for the fourth workshop is underway. It has been agreed that the venue will be Banff, Canada and that it will take place at the end of January 1998. Candidate topics for working-group deliberations are being reviewed both in terms of their individual importance and their potential contribution to the workshop series as a whole. It is hoped that a preliminary announcement can be circulated to potential participants in mid-1997. ©



# Use of Space Technologies for Major-Risk Management

**G. Naja**

Directorate for Strategy, Planning and International Policy, ESA, Paris

## Introduction

Since 1987, the Council of Europe has been administering an intergovernmental agreement concerning the management of natural and technological hazards, known as the 'EUR-OPA Major Hazards Agreement'. This Open Partial Agreement on the prevention of, protection against, and organisation of relief in the event of major natural and technological disasters was

---

**The application of today's and tomorrow's space technologies for the support of environmental risk management has huge development potential. In addition to the indisputable social and economic advantages, it has two very important inherent characteristics: firstly, it results from an independent initiative originating from outside the space world, responding to specific needs defined by the users (the civil-protection authorities); and secondly it does not require the development of new systems, at least in the short- or medium term, as it is based essentially on the coordinated, optimised exploitation of existing and already planned space systems.**

---

adopted on 20 March 1987 by the Council's Committee of Ministers. A Coordinating Group set up under the terms of the Agreement is charged with conducting a multidisciplinary study of the scope for cooperation in coping with natural and technological disasters, including the organisation of relief, training and research based on a network of specialised centres.

The signatories to the EUR-OPA Agreement include Western European countries (France, Belgium, Italy, Spain), Eastern European countries (Russia, Belarus, Georgia, Lithuania) and North African countries (Algeria and Morocco). Austria, Germany and Switzerland have observer status, and international organisations such as UNESCO, the Commission of the European Union and the Red Cross are also involved.

Back in 1994, these signatories requested that a study be made of the potential of space technologies for improving hazard prevention

and emergency assistance, and ESA was asked in May that year to provide technical support to this study. A preliminary study was performed between May and September 1994 for two examples – chemical and seismic risks – using data from existing Western European and Russian satellites as a basis.

It consisted of:

- analysing the needs associated with these two areas of risk, with a view to identifying the potential contribution that space technologies could make
- making an inventory of the available satellite resources both in Western Europe and the Russian Federation that would be able to contribute to meeting these needs.

The results of this study led to three main conclusions:

- Space technologies – mainly Earth observation, meteorology, navigation and telecommunications – can indeed play a useful role in the monitoring, detection and management of major hazards by providing the authorities and operators responsible for risk management with reliable global information on short time scales. For instance, observation satellites contribute to the evaluation of emergency situations; data collection and location satellites contribute to the monitoring of potentially dangerous zones; navigation satellites support the organisation of rescues; meteorological satellites provide data for the forecasts that are so critical when assessing the evolution of major catastrophes; space telecommunications networks complement or even replace ground infrastructures damaged or destroyed during a catastrophe.
- Space technologies *complement* existing ground-based and airborne equipment.
- To be easily exploitable, satellite systems must not require significant changes in the existing decision-making channels specific to each country.

These preliminary conclusions were sufficiently encouraging for ESA to propose to continue the study and to extend it to cover other types of risks and to set up a number of demonstration projects.

A Resolution to this effect was presented to the ministerial meeting on the EUR-OPA Agreement on Major Hazards held in Brussels on 6 October 1994 and was unanimously adopted. With this Resolution,

*'the Ministers request, in view of the importance which they attach to the potential contributions of space technology for major risk management, the continuation of the prospective study undertaken on the use of space technology for the purpose of risk management, concerning monitoring, navigation, telecommunications as well as data collection and transmission'.*

This request by the EUR-OPA signatories was presented to the ESA Council in December 1994 and a set of actions was mapped out for the following year:

- continuation and extension of the preliminary study
- creation of a steering committee, composed, inter alia, of representatives of the European Commission, civil protection authorities, the Secretary of the EUR-OPA Agreement, and ESA

- preparation of a report to be presented in 1996 to the next meeting of the EUR-OPA Agreement and to the relevant ESA Delegate Bodies.

#### **Continuation and extension of the study**

The extended study on the use of space technology for the management of major disasters was divided into four phases:

- The first phase consisted of identifying all of the needs related to the management of major hazards, and was performed by the companies Tractebel (B) and Geste (F).
- The second phase was aimed at complementing the inventory of relevant satellite resources available or planned within 'greater Europe' and was undertaken as an internal ESA activity.
- The third phase of the study consisted of comparing the needs identified within Phase 1 with the available and planned resources identified within Phase 2. Compliance between needs and resources was analysed for each type of risk and an optimal space-based system was defined based on user needs, operational constraints, and associated costs. This third phase, conducted under two parallel contracts with Alcatel Espace (F) and Nuova Telespazio (I), was completed in June 1996.
- The fourth phase of the study consists of evaluating the impact, on the prevention

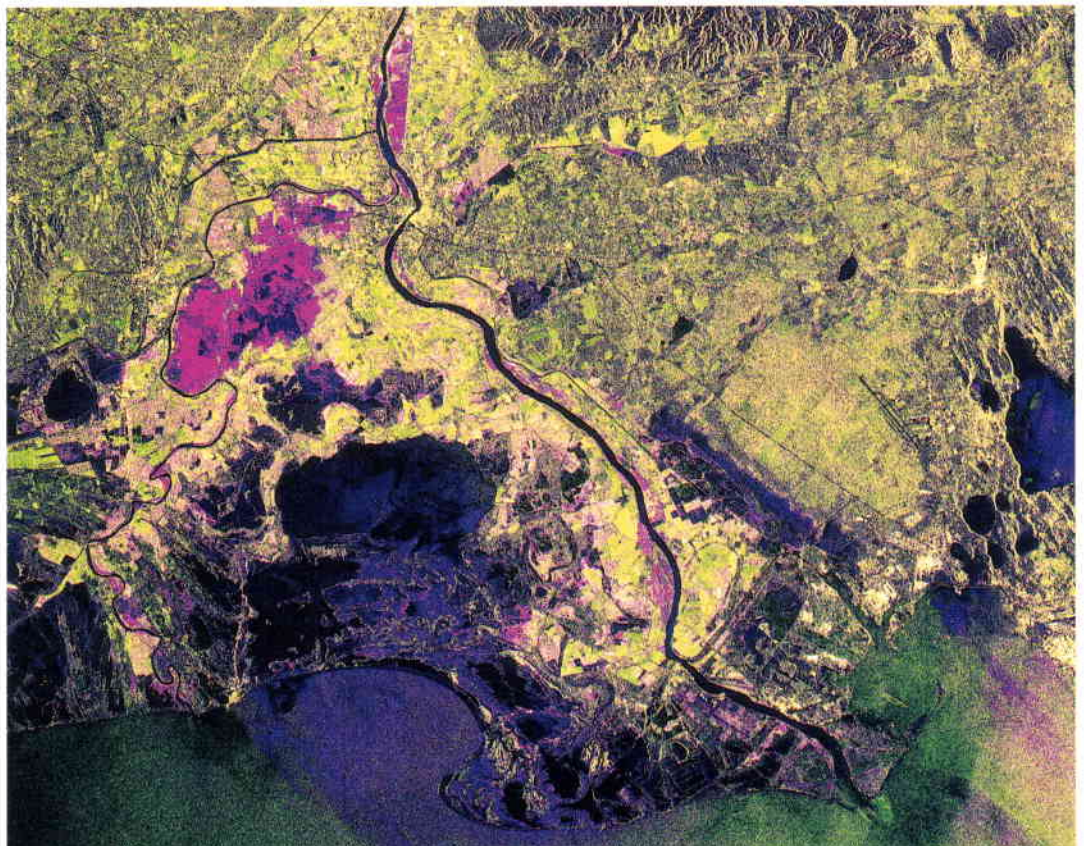

**Figure 1. ERS-1 Synthetic Aperture Radar (SAR) fast-delivery image of the Rhône Delta flooding in January 1994**

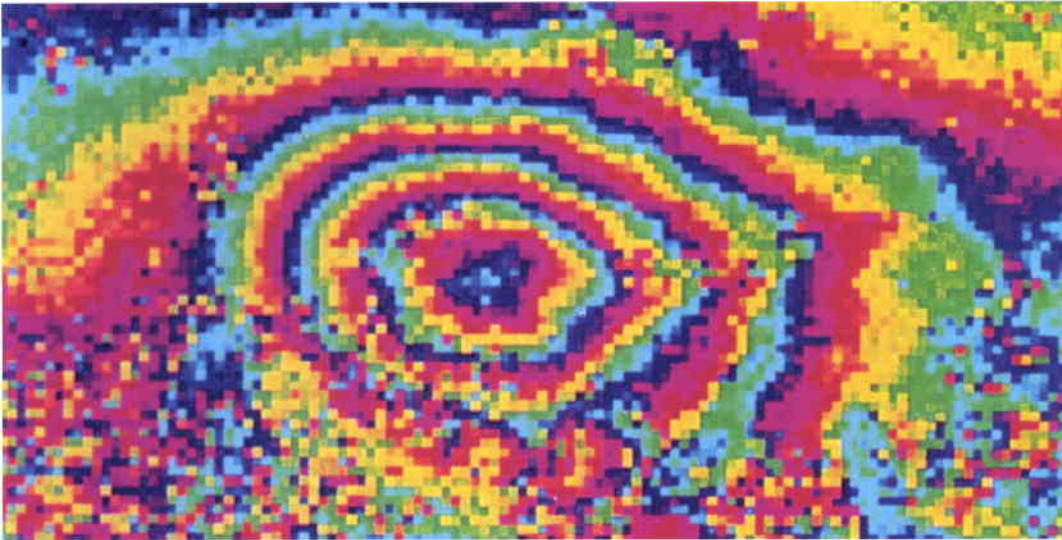

**Figure 2. Interferometric ERS image of an earthquake zone in California's Mojave Desert. The four concentric fringes in the centre are a map of terrain movements with a maximum value of 112 mm in the direction of the satellite (upwards with 23 degrees inclination). This movement is interpreted as an aftershock measuring 5.1 on the Richter scale, which was registered on 4 December 1992, 159 days after the main earthquake. The diameter of the outermost ring is 5 km. Such measurements of terrain displacements with millimetre precision, directly from space and with a minimum of ground surveying, have many potential risk-management applications.**

(Image courtesy of D. Massonet et al., CNES & CNRS).

and management of major hazards, of the space systems and associated ground facilities defined within Phase 3, in cooperation with civil protection organisations. This will be achieved mainly through small pilot projects, two of which, focussing on flood plains and earthquakes, have just been started in January 1997.

### The Phase 1 results

During Phase 1 user needs in terms of spacebased resources and/or products were identified for six major risk areas: forest fires, earthquakes, floods (flood plains, torrential floods, snow melt), transportation of dangerous materials, and nuclear and chemical accidents. Accidents that have occurred recently in greater Europe were studied and analysed, workshops were organised by the civil-protection authorities involved in the management of these accidents, and a questionnaire was widely distributed and the replies were synthesised. The resulting user needs were then classified for each of the three phases of the catastrophe, namely prevention, crisis and post-crisis.

The main needs during the prevention phase were identified in terms of models (e.g. hydrological), risk area cartography and vulnerability maps. There is also a generic need for routine monitoring and basic weather forecasting.

The major needs during the crisis period were identified as alert monitoring (i.e. with increased frequency), cartography of the damage and high-quality weather forecasting. It was also felt necessary to have models simulating the disaster with real data for comparison with the prevention models. The management of the logistical support needed and the rescue effort itself can also be supported by space technologies.

The important needs during the post-crisis phase are those related to damage assessment, and most importantly, the feeding back of disaster data into existing models, in order to improve both their reliability and accuracy.

The main conclusions from this first study phase were that:

- Many countries have the same needs and wishes in terms information and services. There is also a shared feeling that risk management could be improved and that space technologies can contribute to that improvement.
- The data acquired should be transmitted to those responsible operationally in a format fully adapted to their needs, through existing organisations and channels.
- Cost will be a key issue in the use of space systems for risk management.
- Efficient use of space technologies for risk management will require an education and training effort as well as the availability of teams expert in the technical and scientific fields specific to the risk involved.

### The Phase-2 results

This phase, aimed at establishing an inventory of available and planned space resources in greater Europe, was performed as an internal ESA activity. An ESA-prepared questionnaire was addressed to the national space agencies, to Inmarsat, Eutelsat, Eumetsat and to the private European satellite operators (SES, Hispasat, etc.).

The main conclusions that could be drawn from this inventory exercise were that:

- Present space systems can already service a large number of potential risk-management applications, particularly in the fields of communications, meteorology,

**Figure 3. Oil spills, like this one from the wreckage of the tanker Aegean Sea near La Coruña in Northern Spain on 3 December 1992, provide spectacular examples of the disaster-management capabilities of ERS-1. This multitemporal image shows the full extent of the marine pollution on 13 December 1992 (dark green) and what was still left three weeks later, on 2 January 1994 (lighter green).**

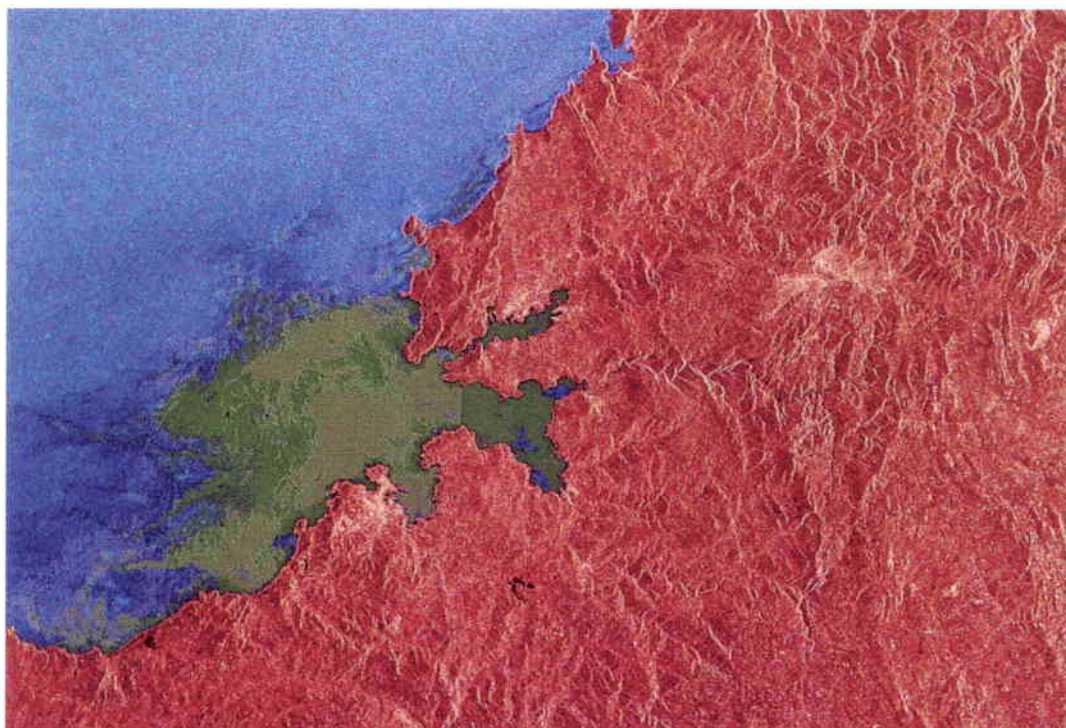

navigation and data collection. Earth-observation satellites already provide a vast quantity of imaging data in different spectral bands and with a variety of spatial resolutions. There are presently some limitations in this context in that, in the warning and crisis phases, products are required within very short time frames.

- Future space systems will cover an even larger number of applications. Global communications systems will facilitate the exchange of information between the risk-management authorities and the operations teams in the field. Future meteorological products will provide improved land-surface and cloud-cover maps. Commercial Earth-observation systems with high spatial resolution will both improve the product quality and ease the data-distribution situation.

### **The Phase-3 results**

The objectives of this phase were to consolidate and possibly complement the user needs identified in Phase 1, validate the space resources identified in Phase 2, and evaluate the match between these needs and existing and planned space resources.

Three scenarios were defined in which space resources are increasingly used for risk-management support, for which a space-based service system was also proposed. The overall findings of this phase were then validated by conducting five practical case studies. Four additional types of risk – volcanic eruptions, storms, droughts and

pipeline accidents – were also evaluated during Phase 3 in prevention, crisis, and post-crisis terms.

The user needs expressed in the ESA interviews conducted during Phase 1 were translated into real technical characteristics (parameters) during this phase to allow easier comparison with space-resource capabilities, both present and future, in the five domains of meteorology, data collection and localisation, navigation, telecommunications, and Earth observation.

Compliance between user needs and available technologies was analysed for three scenarios:

- *Scenario 1:* Making use of currently existing space resources.
- *Scenario 2:* Making use of existing and planned space resources.
- *Scenario 3:* Making use of existing/planned resources and proposing new space-based services.

The overall finding was that *existing* space-based resources can cover approximately 60% of foreseen user needs (the exact percentage varying according to the exact nature of the risk/resource: meteorological, communications, observational, etc.). Taking into account *planned* space-based resources, the degree of compliance rises to approximately 80%.

Some parameters, especially in the field of Earth observation, are technically but not operationally compliant, which could be

improved by better data handling and delivery. Some others, in that same field, cannot be obtained successfully due either to poor spatial resolution (e.g. water temperature or topographic height) or inadequate current knowledge (e.g. soil moisture).

In the field of meteorology, the current non-compliance is due to the inability to satisfy very localised needs covering areas of just a few kilometres. Some parameters, such as frozen soil depth, cannot be obtained from space using available or currently planned techniques. The main shortfalls during the prevention and crisis phases are the lack of risk-area cartography and models, and of accurate local weather forecasts. Coverage is better for flood plains and snow-melt flooding than for torrential floods. For volcanoes, however, only 10% of today's needs can be covered from space, although this figure improves to 80% when already planned future space resources are taken into account. As far as forest fires are concerned, almost 60% of needs are covered by current resources, improving to more than 80% with planned resources. The non-compliant items are mostly in the crisis phases, for alert monitoring and damage cartography.

The degree of compliance also varies with the type of space resource. For instance, current meteorology resources can cover about 80% of the needs, the only ones that cannot be covered being those on a very local scale. Current telecommunications and localisation systems can already fully cover user needs. Existing data-collection systems can meet 50% of user needs, but this can be improved to 80% with planned systems. Current Earth-observation systems can cover about 45% of today's user needs, which could be improved to almost 80% with a radar satellite constellation.

The overall conclusion to be derived from Phase 3, therefore, is that there is still a real need to bridge the gap between the space data and service providers on the one hand and the 'users' – civil and governmental authorities involved in risk management – on the other.

These authorities need to be both informed and convinced of the usefulness of space techniques for supporting risk management. The feeling that 'space is expensive' needs to be mitigated by reducing the cost of space data and services through the centralised provision to operators of high-quality space data products and services for risk-management applications.

These improvements could be brought about by developing a Space Information Service System, which would firstly educate those involved in risk management in the potential of space-based solutions, and secondly would ensure the timely availability of the space products needed for risk prevention and management in the various disciplines.

#### **Follow-on activities**

Based on the success of the small demonstration projects that ESA conducted during Phase 3, to convince the civil protection agencies and governmental authorities of the usefulness of space techniques for dealing with major catastrophes, there is a need for other small short-term pilot projects providing concrete results directly usable by such authorities. The two pilot projects on floods and earthquakes that have been started in January 1997 have as their objective the setting up and testing, for both real and simulated hazard cases, a service providing users (i.e. authorities in charge of risk management) with Earth-observation-derived products with the shortest possible delay. For the flood pilot project, for instance, which will be performed in cooperation with French, Spanish and Italian civil protection agencies and with the support of the Russian Ministry of the Environment (Emercom), three flood-prone areas (plains) in France, Italy and Spain for which some data already exists, such as digital terrain models or hydrological maps, will be selected.

When a catastrophic event – real or simulated – occurs, the user will then have a point of contact which will activate an 'emergency cell'. This cell will ascertain which satellite may have acquired relevant data at the time of the event, procure the data, interpret it and provide the user as quickly as possible with a readily exploitable product. This product, for instance a flood-extent map or an assessment of the vulnerable areas, may be produced by combining the satellite data with existing data from other sources. An important output from this project will also be the feedback obtained from the lessons learnt during the real or simulated crisis, in order to identify where the existing infrastructures and services can be further improved.

An important aspect in the context of these projects is that the driver must be the requirements expressed by the civil-protection authorities, and not the absolute capabilities of the space techniques themselves. ©

# Focus Earth

## ERS Watches Mount Pinatubo

**J. Lichtenegger & G. Calabresi**

ERS Exploitation Section, ESRIN, Frascati, Italy

The island of Luzon with its capital Manila has been struck by two major disasters already this decade: the earthquake in July 1990 and the eruption of Mount Pinatubo in June 1991. The volcanic event in particular is still on people's minds, as every year, during the season of tropical rain storms, the pyroclastic material accumulated on the flanks of the mountain is flushed down towards the rich agricultural land, covering it with metres of fine ash. Lahars are also visible on spaceborne SAR images, like those from the ERS satellites that provide a weather-independent monitoring tool.

The ERS-1 SAR image shown here is a composite of three acquisitions during 1993: 25 July displayed in green, 29 August displayed in red and 3 October displayed in blue. The most colourful part of the image is the plain of Pampanga Province, with the volcanic cone of Mount Arayat in the centre. In the right lower corner, a part of the city of Manila is visible. To the right, one can see hills consisting of tertiary sediment, whilst all mountains to the left are of volcanic origin. Pinatubo is situated to the left, close to the edge of the image; its crater, containing a small lake, is typical. Built-up areas are clearly visible throughout as bright patches, and they also stretch along the main interconnecting roads.

Different colours in the plain indicate different crops: rice fields appear in dark green, sugar cane in green-yellowish hues, and swamp areas in magenta. Just above the volcanic cone of Mount Arayat, patches of intense red, yellow and blue tones are visible: these are plantations of water melons and sugar cane. The large river bed close to this zone appears bright in the image because of the high density of small corrugated-iron-roofed houses built in a zone of fruit-tree orchards.

Although only the eastern slopes of Pinatubo are visible, major land destruction occurred in the valleys and in the coastal plain towards the South China Sea. All rivers originating from the hills surrounding the volcano show enlarged dark-magenta river beds. This is evidence of the presence of mud flows (lahars) that, on their way to the sea, destroyed bridges and power lines, covering the soil with a several-metre-thick layer of white mud. In particular, the northerly running O'Donnell River shows these characteristics. But the other rivers also, such as the Sacobia River which destroyed the USA's Clark Air Base, are clearly discernible to the left of the image's centre. Further down are the Pasig River (see also Fig. 4) and the Gum Ain River (Figs.1 and 2), both of which are also affected by lahars.

If one compares the survey map made in 1991 by the Philippine Institute of Volcanology and Seismology with the ERS images of 1993, the changes that have occurred from one year to the other are remarkable. The ERS SAR picks them up easily thanks to its frequent revisit cycle.

### Acknowledgement

The contribution of Dr. Giovanni Rantucci, who made available his report 'Geological Disasters in the Philippines', as well as maps that were used to refine the image interpretation, is gratefully acknowledged.



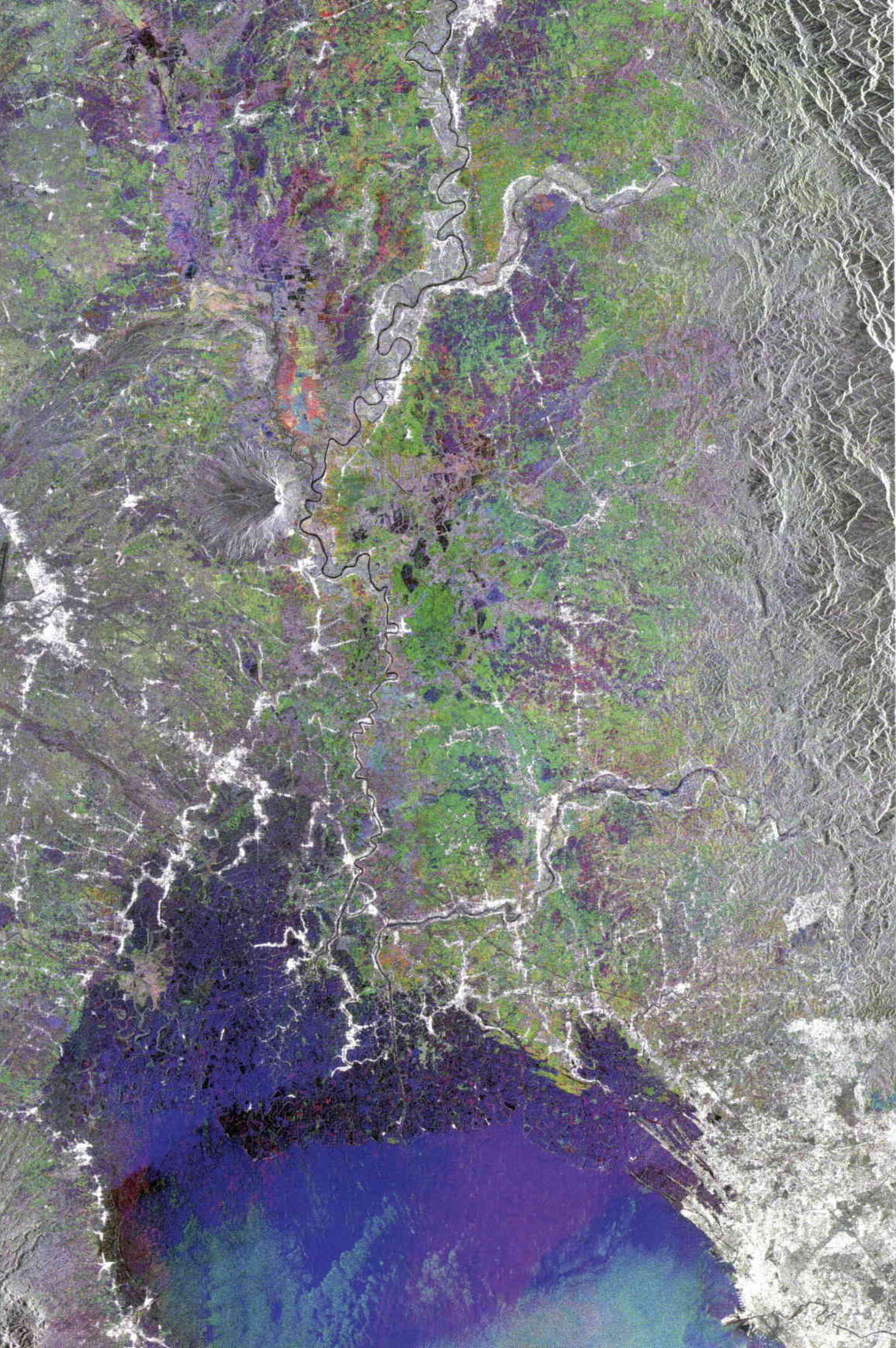

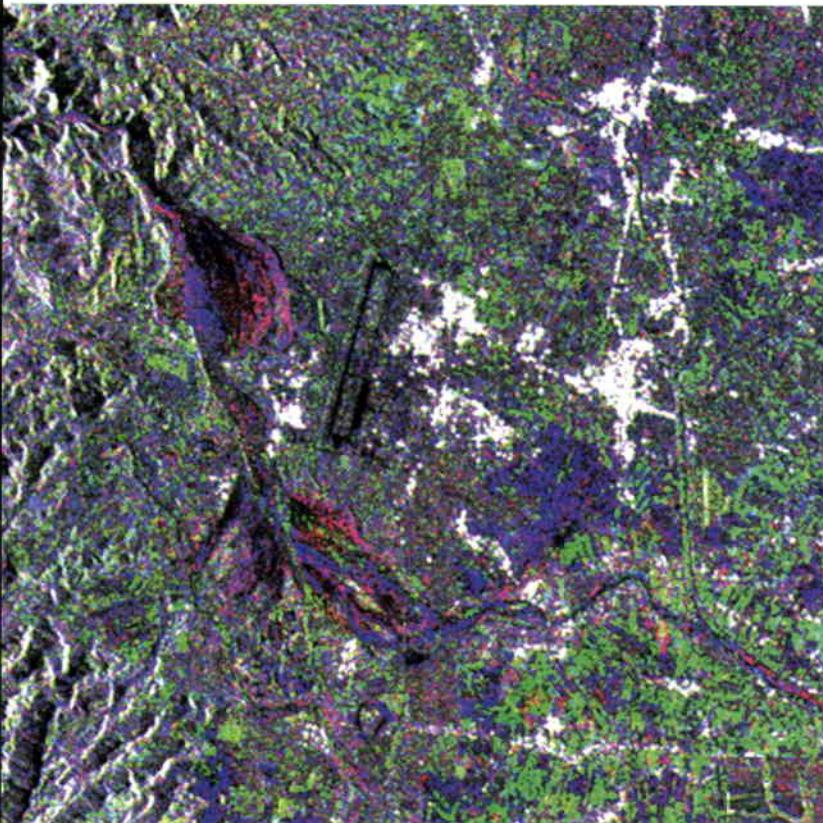

1

Figure 1. Image section near the town of San Jose with the Basa Air Base (lower left in the overview image). The large dark and coloured areas are lahars of 1991 reactivated during the 1993 rainy season. However, the deposits in the prolongation of the runways appear much wider with respect to 1991.

Figure 2. Shrimp farms near the shore in Manila Bay. The very fine network of ponds including the many isolated houses and small settlements are sharply imaged with the ERS SAR. Near the inlet of the Gum Ain River (right), the damage caused to a large number of ponds by the mud flows is evident and the fragile separation dams have disappeared.

Figure 3. A Bacolor taxi-driver desperately digs out his only resource. Some palm trees seem to have survived in the several-metre-deep lahar deposit (photo taken in April 1996).

2

4



Figure 4. In 1995 the town of Bacolor was hit by a lahar directed by the Pasig River bed. All of the houses, including the church, were partially or fully engulfed by the mud. In the background, one can see already repaired power lines (photo taken in April 1996).



3

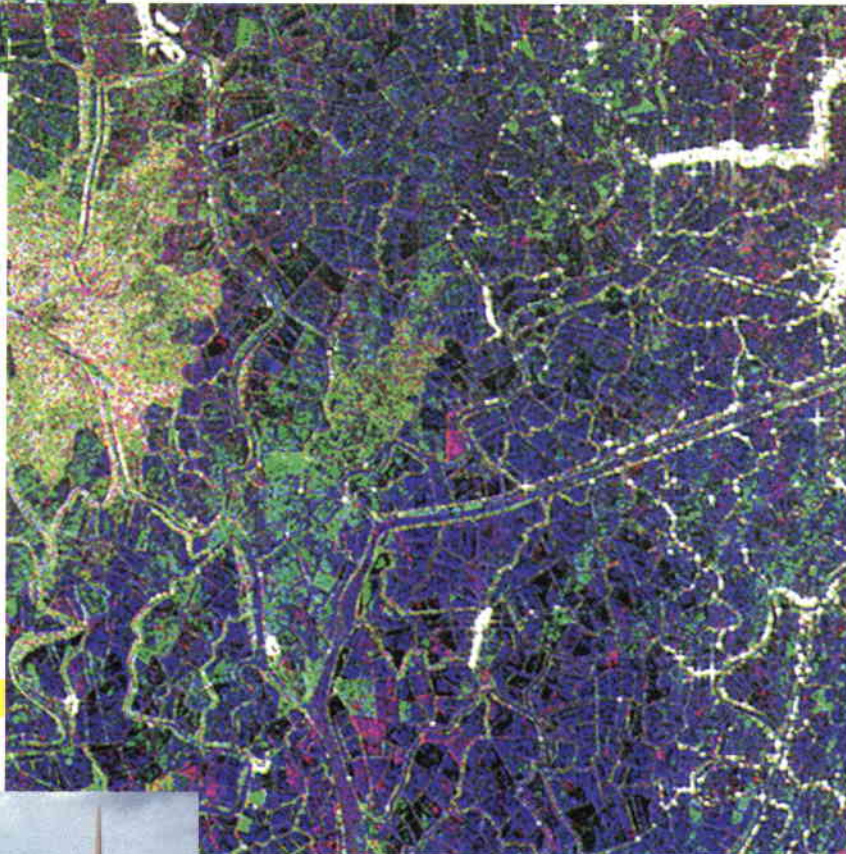



# Programmes under Development and Operations

## Programmes en cours de réalisation et d'exploitation

### In Orbit / En orbite

	PROJECT	1995		1996		1997		1998		1999		2000		2001		COMMENTS										
		J	F	M	A	M	J	J	A	S	O	N	D	J	F		M	A	M	J	J	A	S	O	N	D
SCIENCE PROGRAMME	IUE	[Main Development Phase]												TERMINATED SEPT 1996												
	SPACE TELESCOPE	[Operations]																								LAUNCHED APRIL 1990
	ULYSSES	[Operations]																								LAUNCHED OCTOBER 1990
	ISO	[Main Development Phase]	[Operations]																							LAUNCHED NOVEMBER 1995
	SOHO	[Main Development Phase]	[Operations]																							LAUNCHED DECEMBER 1995
APPLICATIONS PROGRAMME	MARECS - A	[Main Development Phase]												RE-ORBITED AUGUST 1996												
	MARECS - B2	[Main Development Phase]												LEASED TO INMARSAT												
	METEOSAT 4 (MOP-1)	[Main Development Phase]												LIFETIME 5 YEARS												
	METEOSAT 5 (MOP-2)	[Main Development Phase]												LAUNCHED MARCH 1991												
	METEOSAT 6 (MOP-3)	[Main Development Phase]												LIFETIME 5 YEARS												
	ERS - 1	[Main Development Phase]												HIBERNATION SINCE JUNE '96												
	ERS - 2	[Main Development Phase]	[Operations]																							LAUNCHED APRIL 1995
	ECS - 1	[Main Development Phase]												LAUNCHED JUNE 1983												
	ECS - 4	[Main Development Phase]												LAUNCHED SEPT. 1987												
	ECS - 5	[Main Development Phase]												LAUNCHED JULY 1988												

### Under Development / En cours de réalisation

	PROJECT	1995		1996		1997		1998		1999		2000		2001		COMMENTS										
		J	F	M	A	M	J	J	A	S	O	N	D	J	F		M	A	M	J	J	A	S	O	N	D
SCIENTIFIC PROGRAMME	CLUSTER/PHOENIX	[Main Development Phase]	[Operations]																							PHOENIX LAUNCH DEC. 1977
	HUYGENS	[Main Development Phase]	[Operations]																							LAUNCH OCTOBER 1997
	XMM	[Main Development Phase]	[Operations]																							LAUNCH AUGUST 1999
	INTEGRAL	[Main Development Phase]	[Operations]																							LAUNCH APRIL 2001
	ROSETTA	[Main Development Phase]	[Operations]																							LAUNCH JAN. 2003
COMM. PROG.	DATA-RELAY SATELITE (DRS)	[Main Development Phase]												LAUNCH TO BE DECIDED												
	ARTEMIS	[Main Development Phase]												LAUNCH EARLY 2000												
EARTH OBSERV. PROGRAMME	EARTH OBS. PREPAR. PROG. (EOPP)	[Main Development Phase]																								
	ENVISAT 1/ POLAR PLATFORM	[Main Development Phase]												LAUNCH MID-1999												
	METOP-1 PREP. PROG.	[Main Development Phase]																								
	METEOSAT TRANSITION PROG.	[Main Development Phase]	[Operations]																							LAUNCH JULY-SEPT 1997
MANNED SPACE PROGRAMME	MSG-1	[Main Development Phase]	[Operations]																							LAUNCH OCTOBER 2000
	COLUMBUS (COF)	[Main Development Phase]	[Operations]																							LAUNCH NOV 2002
	ATV	[Main Development Phase]	[Operations]																							LAUNCH APRIL 2002
	ERA	[Main Development Phase]	[Operations]																							LAUNCH NOV 1999
	DMS (R)	[Main Development Phase]	[Operations]																							LAUNCH APRIL 1996
	ARD	[Main Development Phase]	[Operations]																							LAUNCH UNDER REVIEW
	MICROGRAVITY	[Main Development Phase]	[Operations]																							
	EUROMIR-E	[Main Development Phase]	[Operations]																							LAUNCH AUGUST 1997
LAUNCH PROG.	ARIANE 5	[Main Development Phase]	[Operations]																							FIRST LAUNCH MAY 1996
	ARIANE-5 EVOLUTION	[Main Development Phase]	[Operations]																							FIRST LAUNCH END 2002

■ DEFINITION PHASE

■ MAIN DEVELOPMENT PHASE

▲ LAUNCH/READY FOR LAUNCH

■ OPERATIONS

■ ADDITIONAL LIFE POSSIBLE

▼ RETRIEVAL

## Cluster

Integration of the spacecraft known as 'Phoenix', which relies on spare units from the original Cluster programme, is progressing according to plan. The subsystem and payload units have been delivered and are in the process of being functionally tested at Dornier's (D) premises. The spacecraft will be transported to IABG (D) at the end of March for the environmental test programme. It will then be delivered by mid-1997, ready for a potential launch at the end of the year.

The two options for a complete Cluster recovery mission, called Cluster-II, are still being studied. At the ESA Science Programme Committee's (SPC) November meeting, authorisation was given to put before the Agency's Industrial Policy Committee (IPC) a proposal to procure three new spacecraft based on the original Cluster specifications. These three spacecraft, which together with Phoenix make up Option 1 for Cluster-II, would be ready for launch by mid-2000. Option 2 comprises simpler spacecraft carrying essentially the same payload as Cluster, but capable of being launched more cheaply into a direct polar orbit. The SPC will discuss both options at its February 1997 meeting.

## Huygens

Flight-model Probe acceptance testing has continued, in accordance with the programme designed to demonstrate the integrity of the Probe's design and construction. The last of the severe environmental tests — acoustic noise and vibration — have been completed without mishap, permitting electrical functional testing to continue without delay. A number of specific tests on experiment units, subsystem units and modules have also been carried out, and there have also been specific activities for the exchanging of hardware items.

Currently, the Probe is assembled in the 'entry-module configuration' and is undergoing the first part of the system-level electro/mechanical compatibility testing programme. The EMC testing, which was halted during the Christmas vacation period, has been resumed early in January.

Everything now appears set for a successful Flight Acceptance Review in March, with the launch campaign planned to start at the beginning of April.

## XMM

The main development phase (Phase-C/D), with Dornier (D) as Prime Contractor, is advancing as planned with the good development of the flight-model units, some of which have already been delivered. Production of the four flight-model Mirror Modules is also progressing according to plan, with deliveries of mirrors of good quality. By the end of 1996, the first Mirror Module had been almost fully integrated, and production of the second Module was proceeding well in parallel.

In order to ensure the maximum scientific return from the XMM mission, it has been decided to implement a so-called 'X-Ray Baffle' on the spacecraft. This will have no impact on the overall production schedule.

Manufacturing and testing of the engineering qualification models of the experiments is still in process. The grating spectrometer and one of the X-ray cameras have been successfully tested with the mirror qualification model in the PANTER facility (D). The mirrors for the optical monitoring telescope have been polished.

The development of the Ground Segment at ESOC in Darmstadt (D) has been progressing according to plan, and definition of the technical interfaces with the Ariane launcher for the planned highly elliptical orbit is almost complete.

---

*Production of an XMM flight-model mirror shell, with a gold-plated mandrel being prepared for nickel electro-forming*



## Integral

The spacecraft main-development-phase (Phase-C/D) activities were kicked-off in October, with the closure of all points raised during the Preliminary Design Review. Following further internal reviews, successful negotiations and official approval from the Agency's Industrial Policy Committee, the contract with Alenia (I), the Prime Contractor, was signed in Paris on 6 November. The final negotiations and contract signatures with the subcontractors are in process and are expected to be completed in the second quarter of 1997.

The payload instruments are progressing. A joint ESA/CNES task force has conducted a detailed review of the Spectrometer's schedule and its interfaces to the spacecraft development schedule. Workarounds have been identified and better synchronisation has been achieved such that the overall mission plan remains unchanged.

## Rosetta

Evaluation of the industrial offers for the Prime Contractorship for Rosetta has been completed and Phase-B is due to start at the beginning of March. The overall system design will then start to be refined and frozen so that procurement specifications for the main sub-contractors can be issued as soon as possible. The Preliminary System Requirements Review will be held by the last quarter of 1997 with the major sub-contractors under contract.

The technical definition of the Orbiter's payload is progressing satisfactorily and will lead to the Experiment Conceptual Design Reviews (ECDRs) to be held between March and May 1997. Final confirmation of the funding of the selected payload by the ESA Member States is expected at the February 1997 meeting of the Agency's Science Programme Committee (SPC).

Due to the uncertainty about the availability of resources, both technical and financial, it has been decided to amalgamate the two Surface Science Packages (SSPs) into one slightly larger Lander which can meet most of the scientific requirements. Due to this late re-definition, the status of the SSP is not as

mature as that of the rest of the Orbiter payload. However, a crash-action is underway to define the interfaces sufficiently to start the industrial Phase-B and hold the ECDR in May 1997.

Ground-segment definition is progressing satisfactorily and it has been decided to augment the ESA ground-station complement with a 32 m-dish Deep-Space Terminal in the Southern Hemisphere. This station will also be used for other ESA missions. The Invitation-to-Tender for this new terminal has been issued and the industrial procurement is planned to start in the second half of 1997.

*Artemis structural model during vibration testing at ESTEC*

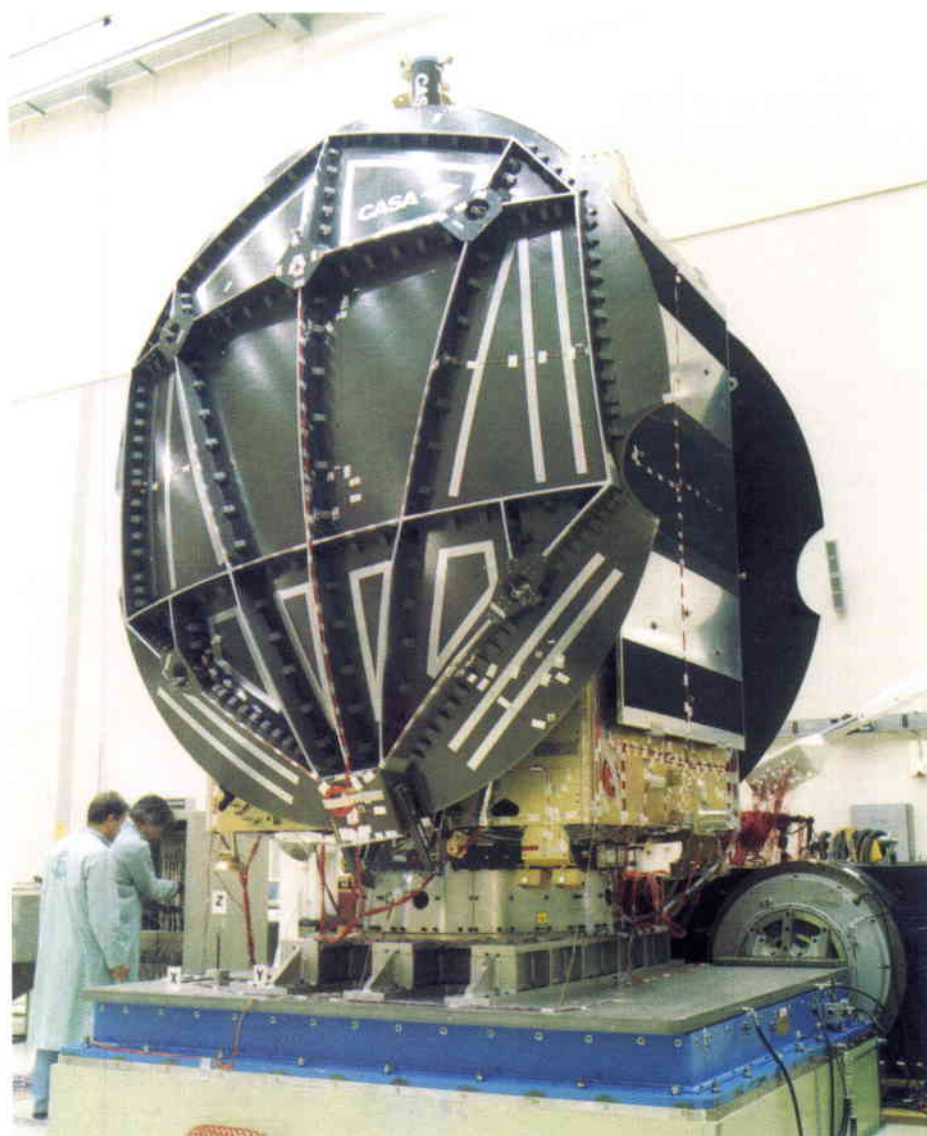

## Artemis

### Satellite

The Artemis satellite structural model is now at ESTEC undergoing environmental testing. Acoustic testing has been successfully completed and vibration testing is underway.

The satellite engineering model is fully integrated in the Alenia (I) facility in Rome ready for electrical system testing to start.

Integration of the flight-model satellite has started with installation onto the structure of propulsion and thermal-control equipment. Delivery of other flight equipment is underway and is planned to be completed during the next few months.

Under a Memorandum of Understanding which is being agreed with the Japanese Space Agency (NASDA), Artemis will be launched on the HII-A vehicle and in return Artemis data-relay capacity will be made

available to Japanese satellites. As a result of this agreement, the launch of Artemis has been rescheduled for winter 1999/2000.

#### Ground segment

A review of the design of the ground segment for operating the Artemis satellite has been completed successfully and the full implementation phase has started.

#### Silex LEO terminal

The Silex LEO terminal has been fully integrated and its environmental testing is underway. Delivery for integration on the French Spot-4 spacecraft is planned for February 1997.

## EOPP

#### Future programmes

The four missions for Phase-A study recommended to the Earth-Observation Programme Board were unanimously endorsed, namely:

- the Gravity and Steady-State Ocean Circulation Mission
- the Atmospheric Dynamics Mission as an experiment utilising the International Space Station
- the Earth Radiation Mission, and
- the Land Surface Processes and Interaction Mission.

Unfortunately, formal approval for the Phase-A mission studies can not be obtained until the necessary subscriptions to the next five-year slice of EOPP have been secured.

#### Campaigns

Activities are limited to the last three campaigns supported by EOPP, namely EMAC, POLRAD and INDREX. All are now in their data-evaluation phases.

## Polar Platform/Envisat

The Polar Platform/Envisat-1 mission is the most challenging ESA has ever undertaken in the field of Earth Observation. It will not only provide continuity for space-acquired ocean, land and ice data from ERS-1 and ERS-2, but will also gather information on atmospheric constituents and Earth-surface features that will be

invaluable for environmental research and applications purposes.

The instrument payload is a combination of six ESA-developed instruments (EDIs) and three Announcement of Opportunity Instruments (AOIs).

Envisat-1 is foreseen to be launched in mid-1999 by an Ariane-5 into a Sun-synchronous, near-polar orbit in which it will circle the Earth some 14 times per day. The mission is expected to provide continuous global data for at least five years.

#### Envisat-1 system

The Critical Design Reviews (CDRs) of the various Envisat subsystems are proceeding according to plan. In particular, all instrument CDRs and the Flight Operations Segment (FOS) CDR were completed before the end of 1996. The Polar Platform CDR is planned to be held in parallel with the Envisat Mission and System (EMS) CDR, starting in mid-February.

The work of the Data Policy Working Group is progressing and its recommendations are expected early in 1997

regarding, in particular, the conditions of the Announcement of Opportunity for Scientific Data Exploitation and Pilot Projects, and the more general policy for data-product distribution to users.

Significant progress has been achieved in the detailed definition of the data products and corresponding processing algorithms for all of the Envisat instruments. A comprehensive status report was presented to Programme Participant representatives (DOSTAG) at the end of October.

#### Polar Platform (PPF)

Following the successful execution of the acoustic, shock and modal-survey tests, the Polar Platform structural-model activities were put on hold awaiting availability of the Hydra Test Facility at ESTEC at the end of the year.

The engineering-model (EM) Payload Module started its integration at Matra

*Structural model of the Polar Platform (PPF) in the Hydra Test Facility in January 1997*



Marconi Space in Bristol (UK), with the assembly of the EM Payload Equipment Bay (PEB) delivered by DASA/Dornier (D) and the Payload Carrier manufactured by CASA (E). Thereafter, integration of the EM instrument models has started and will continue over the next few months. The MIPAS instrument has already been successfully integrated.

The flight-model PEB is being integrated at DASA/Dornier, where most flight units are already available.

The proto-flight Service Module integration has been completed and acceptance testing is in progress. The next major test, the thermal-balance/thermal-vacuum test, was scheduled to take place in the ESTEC LSS facility in December.

The Ariane-5 Launch Service Agreement (LSA) has been concluded with Arianespace.

#### **Envisat-1 payload**

Development of the Envisat payload instruments has been progressing well. The MTSR, MIPAS, SCIAMACHY and GOMOS engineering models have been delivered to the PPF Prime Contractor, Matra Marconi Space in Bristol (UK), for integration with the EM Polar Platform. Delivery of the engineering model of the RA2 instrument was planned for December.

Work is also progressing well on the instrument flight models (FM), for which most of the subsystems and equipment units are in manufacturing and testing.

After a lengthy evaluation and careful screening, the flight-model Charge-Coupled Devices (CCDs) for the MERIS and GOMOS instruments have been selected. In both cases, excellent performances have been secured for these components which are a vital part of these instruments.

#### **Envisat-1 ground segment**

The Payload Data Segment (PDS) industrial-contract negotiations have been finalised and the contract was signed on 9 December.

The Flight Operation Segment (FOS) Critical Design Review, which is currently in progress, is aimed at demonstrating the completeness and coherency of the documentation, the interfaces and the

corresponding developments. Two development activities are still to be kicked-off in 1997: the development of the FOS Mission Planning System and the Kiruna TTC Station upgrade.

## **Meteosat Second Generation**

The SEVIRI (Scanning Enhanced Visible and Infra-Red Imager) telescope and scan assembly has been re-designed, the telescope has undergone a Preliminary Design Review (PDR), and its engineering-model and mechanical/thermal-model equipment manufacture has been released. The Scan Assembly PDR is now planned for early 1997, with the SEVIRI schedule remaining on a critical path.

The combined contract for MSG-1 and MSG-2/3 between ESA and Aerospatiale was signed in October 1996. This signature was preceded by the ESA and Eumetsat agreement that ESA should act as the procurement agent for MSG-2/3 on behalf of Eumetsat, which is fully financing these two recurrent models.

The launch of MSG-1 remains scheduled for October 2000, with MSG-2 to be launched in 2002 and MSG-3 to go into storage in 2003.

## **METOP**

The METOP Phase-B was successfully completed with the System Requirements Review held in November/December 1996. The definition of the design and implementation of the satellite is fully ready for the start of the main development phase (Phase-C/D).

Payload definition has been finalised, with the selection of the GOME instrument from ERS-2 as the ozone-monitoring instrument on Metop-1 and -2 and the alternative ImS instrument now proposed for flight on Metop-3.

The preparations required within Eumetsat, and ESA approval of the combined EPS/METOP programme, are currently in a final stage. A small number of important issues remain to be resolved, however, before this approval can be realised.

If the ESA Programme is agreed, advance industrial activities could start in the first quarter of 1997, with the full Phase-C/D kick-off anticipated towards the end of the year.

## **Meteosat**

The Meteosat Transition Programme (MTP) spacecraft has been fully integrated and all the major environmental tests will be performed in early 1997 and then the final performance tests will be carried out in preparation for the flight-readiness review in May. Launch on an Ariane-4 vehicle is anticipated in the July to September time frame. This MTP spacecraft will be the last of the Meteosat Operational Programme (MOP) design to be launched.

Once launched, the MTP spacecraft will be operated by Eumetsat to provide the regular weather pictures over Europe currently being provided by Meteosat-5, with Meteosat-6 as the in-orbit spare. Both of these spacecraft were provided under ESA contracts.

## **ERS**

ERS-2 has continued to meet the routine mission requirements with high availability of all instruments. ERS-1 is now in hibernation after five years of operation and, having exhibited little performance degradation, is serving as a back-up.

## **Euromir-E**

After the highly successful Euromir missions in 1995 and 1996, ESA has now reached an agreement with the Russian partners on additional post-mission activities. This Euromir-E (Extension) programme will involve two Russian cosmonauts aboard Mir providing support for several ESA experiments on the station during the second half of 1997. The planned investigations are based on re-runs of about 15 Euromir 95 experiments exploiting existing ESA hardware on board.



# ARIANESPACE

## The world's space transportation company

Arianespace is tying together telecommunications networks with satellite operators and constructors as partners and customers. These global networks support direct television broadcasting, offer enhanced meteorological capacity, make it easier to observe the Earth and open the way to space-based scientific programs. With the arrival of Ariane 5 alongside Ariane 4, Arianespace is not only gaining greater launch capacity but also making its complete service even more adaptable and readily available. By placing at least ten satellites in orbit every year, Arianespace is making space work to make life easier for everyone.



**The world's first commercial space transportation company**

Arianespace, boulevard de l'Europe, BP 177, 91006 Evry Cedex, France. Tél. +(33 1) 60 87 60 00  
Arianespace, Inc., 700, 13 th Street, N.W., Suite 230 Washington, D.C., 20005 U.S.A. Tel. +1 (202) 628-3936  
Arianespace Tokyo, Hibiya Central Building 1-2-9, Nishi-Shimbashi-Minato-ku, Tokyo 105, Japan. Tel. +81(3) 3592-2766  
Arianespace, Shenton House # 25-06, 3 Shenton Way, Singapore 058805

## In Brief

### HST Faint-Object Camera Unmasks 'Cosmic Gamma-Ray Machine'

The European Space Agency's Faint Object Camera on the Hubble Space Telescope has identified a neutron star, the smallest and densest type of star that exists, lying approximately 3000 light-years away in the southern sky. It is 100 million times dimmer than faint stars seen with the naked eye. Thus the Faint Object Camera is living up to its name by revealing objects in the Universe close to the limit of visibility.

The new-found neutron star is the visible counterpart of a pulsating radio source, Pulsar 1055-52. It is a mere 20 km wide. Although the neutron star is very hot, about a million degrees centigrade, very little of its radiant energy takes the form of visible light. It emits mainly gamma-rays, an extremely energetic form of radiation. By examining it at visible wavelengths, astronomers hope to figure out why Pulsar 1055-52 is the most efficient generator of gamma-rays known so far, anywhere in the Universe.

The Faint Object Camera found Pulsar 1055-52 in near-ultraviolet light at 3400 angstroms, a little shorter in wavelength than the violet light at the extreme of the human visual range. Roberto Mignani, Patrizia Caraveo and Giovanni Bignami of

the Istituto di Fisica Cosmica in Milan, Italy, report its optical identification in the 1 January 1997 issue of *Astrophysical Journal Letters*. The object's formal name is 'PSR 1055-52'.

#### Evading the glare of an adjacent star

The Italian team had tried since 1988 to spot Pulsar 1055-52 with two of the most powerful ground-based optical telescopes in the Southern Hemisphere: the 3.6 m Telescope and the 3.5 m New Technology Telescope at the European Southern Observatory in La Silla, Chile. Unfortunately, an ordinary star 100 000 times brighter lay in almost the same direction in the sky, separated from the neutron star by only a thousandth of a degree. The Earth's atmosphere defocused the star's light sufficiently to mask the glimmer from Pulsar 1055-52. The astronomers therefore needed an instrument in space and the Faint Object Camera offered the best precision and sensitivity to continue the hunt.

Devised by European astronomers to complement the American wide-field camera on the Hubble Space Telescope, the Faint Object Camera has a relatively narrow field of view. It intensifies the image of a faint object by repeatedly accelerating electrons from photo-electric films, so as to produce brighter flashes when the electrons hit a phosphor screen. Since Hubble's launch in 1990, the Faint Object Camera has examined many different kinds of cosmic objects, from the moons of

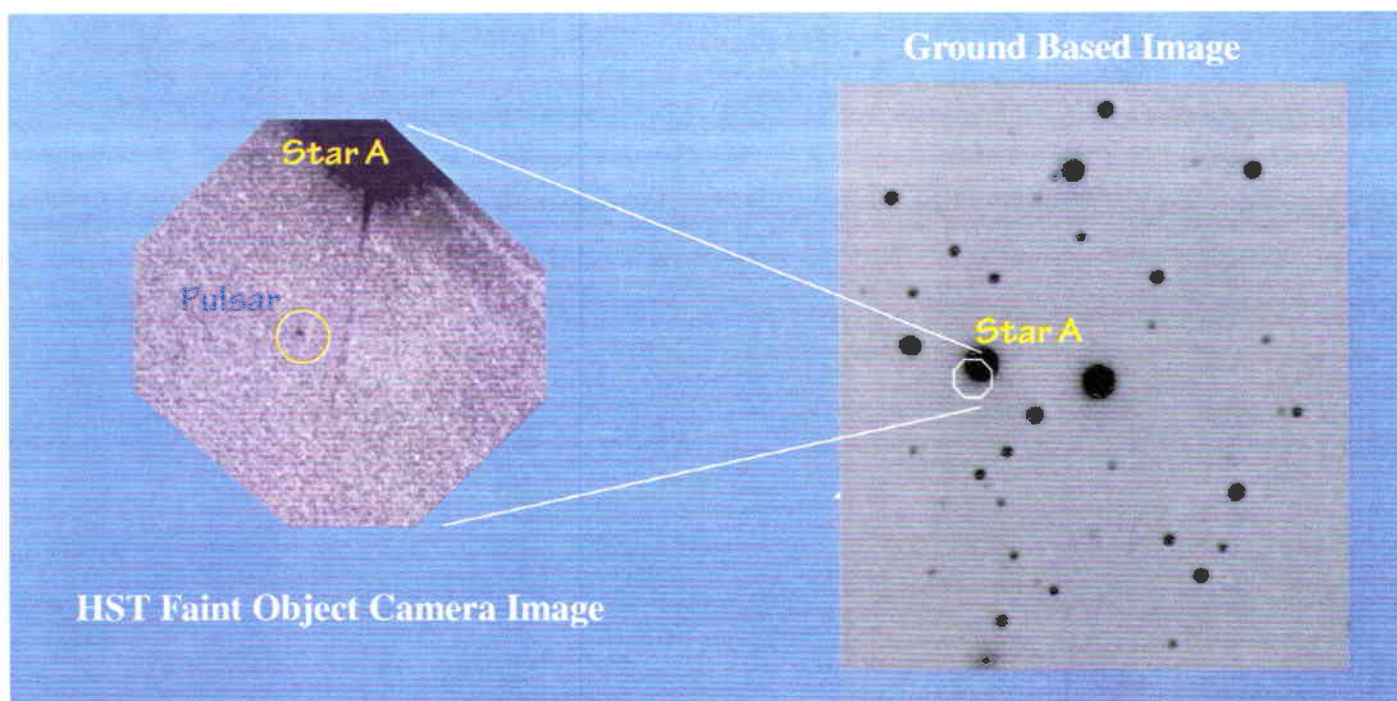

Jupiter to remote galaxies and quasars. When the Space Telescope's optics were corrected at the end of 1993, the Faint Object Camera immediately celebrated the event with the discovery of primeval helium in intergalactic gas.

In their search for Pulsar 1055-52, the astronomers chose a near-ultraviolet filter to sharpen the Faint Object Camera's vision and reduce the adjacent star's huge advantage in intensity. In May 1996, the Hubble Space Telescope operators aimed at the spot which radio astronomers had indicated as the source of the radio pulsations of Pulsar 1055-52. The neutron star appeared precisely in the centre of the field of view, and it was clearly separated from the glare of the adjacent star. At magnitude 24.9, Pulsar 1055-52 was comfortably within the power of the Faint Object Camera, which can see stars 20 times fainter still.

'The Faint Object Camera is the instrument of choice for looking for neutron stars', says Giovanni Bignami, speaking on behalf of the Italian team. 'Whenever it points to a judiciously selected neutron star it detects the corresponding visible or ultraviolet light. The Faint Object Camera has now identified three neutron stars in that way, including Pulsar 1055-52, and it has examined a few that were first detected by other instruments'.

### Mysteries of the neutron stars

The importance of the new result can be gauged by the tally of only eight neutron stars seen so far at optical wavelengths, compared with about 760 known from their radio pulsations, and about 21 seen emitting X-rays. Since the first pulsar was detected by radio astronomers in Cambridge, England, nearly 30 years ago, theorists have come to recognise neutron stars as fantastic objects. They are veritable cosmic laboratories in which nature reveals the behaviour of matter under extreme stress, just one step short of a black hole.

A neutron star is created by the force of a supernova explosion in a large star, which crushes the star's core to an unimaginable density. A mass greater than the Sun's is squeezed into a ball no wider than a city. The gravity and magnetic fields are billions of times stronger than the Earth's. The neutron star revolves rapidly, which causes it to wink like a cosmic lighthouse

as it swivels its magnetic poles towards and away from the Earth. Pulsar 1055-52 spins at five revolutions per second.

At its formation in a supernova explosion, a neutron star is endowed with two main forms of energy. One is heat, at temperatures of millions of degrees, which the neutron star radiates mainly as X-rays, with only a small proportion emerging as visible light. The other power supply for the neutron star comes from its high rate of spin and a gradual slowing of the rotation. By a variety of processes involving the magnetic field and accelerated particles in the neutron star's vicinity, the spin energy of the neutron star is converted into radiation at many different wavelengths, from radio waves to gamma-rays.

The exceptional gamma-ray intensity of Pulsar 1055-52 was first appreciated in observations by NASA's Compton Gamma Ray Observatory. The team in Milan recently used the Hubble Space Telescope to find the distance of the peculiar neutron star Geminga, which is not detectable by radio pulses, but is a strong source of gamma-rays. Pulsar 1055-52 is even more powerful in that respect. About 50% of its radiant energy is gamma-rays, compared with 15% from Geminga and 0.1% from the famous Crab Pulsar, the first neutron star seen by visible light. Making the gamma-rays requires the acceleration of electrons through billions of volts. The magnetic environment of Pulsar 1055-52 fashions a natural gamma-ray machine of amazing power. The orientation of the neutron star's magnetic field with respect to the Earth may contribute to its brightness in gamma-rays.

Geminga, Pulsar 1055-52 and another object, Pulsar 0656 + 14, make a trio that the Milanese astronomers call 'The Three Musketeers'. All have been observed with the Faint Object Camera. They are isolated, elderly neutron stars, some hundreds of thousands of years old, contrasting with the 942 year-old Crab Pulsar, which is still surrounded by dispersing debris of a supernova seen by Chinese astronomers in the 11th Century. The mysteries of the neutron stars will keep astronomers busy for years to come, and the Faint Object Camera on the Hubble Space Telescope will remain the best instrument for spotting their faint visible light.

An image is available of: (i) PSR 1055-52 as seen by ESA's Faint Object Camera on HST, and (ii) the same region of the sky seen by the European Southern Observatory's New Technology Telescope, with the position of PSR 1055-52 indicated. It can be found on the World Wide Web at:

<http://ecf.hq.eso.org/stecf-pubrel.html>

## Czech Republic and ESA Sign Cooperation Agreement

The Minister for Education, Youth and Sports of the Government of the Czech Republic, Mr Ivan Piliip, and ESA's Director General, Mr Jean-Marie Luton, have signed a Cooperation Agreement concerning the exploration and use of outer space for peaceful purposes.

The aim of the Agreement is to establish the framework for cooperation in areas of mutual interest, in particular:

- space science
- Earth observation research and applications
- satellite telecommunications
- microgravity research
- ground segment engineering and utilisation.

The Czech Republic and ESA plan to interchange information in these areas, largely by facilitating the exchange of scientists, engineers and industry contacts. This could lead to the conclusion of specific arrangements on agreed projects including the possibility for the Czech Republic to participate in ESA programmes.

The Agreement, which was signed on 7 November 1996 in Prague, has a duration of 5 years with a possibility for renewal. In order to execute the obligations set forth, each party is expected to meet its own costs.



## SOHO Birthday Greetings

Launched on 2 December 1995, SOHO recently celebrated its first year in space. As the images and other data continue to pour from SOHO at a high rate, a revolution in solar science is in progress.

Among many solar experts who are enthusiastic about SOHO's successes is the leading astrophysicist, Evry Schatzman of the Observatoire de Meudon (France).

'On SOHO's first birthday', Schatzman says, 'I congratulate my European and American colleagues on the most remarkable and successful spacecraft ever devoted to examining the star on which our lives depend. SOHO's astounding ability to probe the Sun's interior by helioseismology gives me hope that we shall at last solve the ancient mystery of the sunspots and the magnetic cycle. The observations of ultraviolet rays and energetic particles give us our best chance of understanding the hot atmosphere and its emissions into the solar system. But to fulfil its high promise, SOHO must continue to operate at least until the maximum of sunspot activity around the year 2000.'

Joining in SOHO's anniversary greetings is Eigil Friis Christensen, a solar-terrestrial physicist at the Danish Meteorological Institute, who has played a prominent role in tracing the effects of solar variations on the terrestrial climate:

'SOHO is now vital for understanding the Earth's environment. I am convinced that long-term changes in the strength and variability of the solar wind alter the climate, but no one knows why those changes occur. In the years ahead, as it follows the dramatic events leading from the sunspot minimum to the sunspot maximum, SOHO should reveal the processes inside the Sun that influence the character of the solar wind. If so, it will open a new chapter in solar-terrestrial climatology.'

## SOHO Receives Popular Science Award

SOHO was recently selected as one of the greatest 100 achievements in science and technology for 1996 by Popular Science Magazine. The award, which is given annually for new technology products or ground-breaking scientific discoveries, bases the selection criteria on one main point: 'each innovation must make a positive difference in our lives'. SOHO is described as the first unblinking

observer of our Sun which has already made spectacular finds, '...even though the Sun is now in its quieter state - the lull in the roughly 11-year sunspot cycle - it's still a roiling, violent place subject to fits of exploding fireballs and fantastically twisting magnetic fields'.

Other winners in the same category were 'Life on Mars', 'Discovery of Comet Hyutake' and 'NASA's Near-Earth Asteroid Rendezvous Mission (NEAR)'. ©



On behalf of SOHO, Mr Vicente Domingo (ESA) accepts the Popular Science 'Best of What's New' award for 1996.

## Ariane V92, Successfully Launched

The 92nd Ariane launch took place successfully on Wednesday, 13 November 1996 at 07:40 p.m. Kourou time (11:40 p.m. Paris time).

An Ariane 44L version launcher (equipped with 4 liquid strap-on boosters) placed the Arabian and Malaysian telecommunication satellites ARABSAT IIB and MEASAT 2 into geostationary orbit. ©

## Second European Conference on Space Debris

After the success of the first conference in 1993, the European Space Agency is organising the Second European Conference on Space Debris to be held 17-19 March 1997 at its European Space Operations Centre (ESOC) in Darmstadt, Germany. The British National Space Centre (BNSC) as well as the space agencies from France (CNES), Germany (DARA) and Italy (ASI), and the International Academy of Astronautics (IAA), are co-sponsoring this event which will draw over 200 experts from Europe, the United States, Canada, Russia, Japan and China.

Space debris is of growing concern for manned and unmanned spaceflight. The first confirmed hypervelocity collision between an operational spacecraft (CERISE) and a tracked fragment of an upper stage occurred in July 1996.

The purpose of the conference is to provide a forum for the presentation of results from research on space debris; to assist in defining future directions for research; to identify methods of debris control, reduction and protection; and to discuss international implications and policy issues.

At the conference, measurements of space debris and meteoroid population made from the ground and in space will be discussed, along with the results of modelling efforts and supporting ground tests predicting the debris population and its evolution in both the short- and long-term. (See this In Brief, article entitled 'The COBEAM Experiment'.) The conference will also focus on the impact of multi-satellite constellations on the space environment, protection of the International Space Station from debris and meteoroids, and risk assessment in the various orbital regions. Since rules governing space vehicle design and operations with respect to space debris will ultimately be required, policy issues will also be addressed.

A round-table discussion scheduled for 19 March will explore the further steps to be taken in the space debris field.

For further information, please contact:  
W. Flury  
ESOC  
Robert-Bosch-Str. 5  
64293 Darmstadt  
Germany

Tel: + 49 6151 902 270  
Fax: + 49 6151 902 625  
E-mail: wflury esoc.esa.de

The Proceedings of the Conference will be available from ESA Publications Division at the end of April as ESA Special Publication SP-393.

## ENVISAT-1 Payload Data Segment Development Contract Signed

Mr Jean-Marie Luton, ESA's Director General, and Mr Alain Delecroix, Chairman of Thomson-CSF Services et Systèmes Sol Spatiaux, signed the contract for the development of the ENVISAT-1 Payload Data Segment (PDS) on 9 December 1996 at ESRIN, ESA's Earth Observation Missions Exploitation Centre in Frascati, Italy.

ENVISAT-1, ESA's most ambitious and complex satellite, to be launched in mid-1999, will be the successor to the ERS Earth observation satellites. Carrying on from the ERS-1 and ERS-2 missions, it will provide the user community with enhanced observation of the Earth and its environment in the field of atmospheric constituents and Earth-surface features, maintaining the flow of data well into the next century.

This contract covers the development and installation of the data management, data acquisition, data processing, and corresponding user service interfaces at the two ESA sites involved, ESRIN in Italy and the Kiruna/Salmijärvi station in Sweden.

It also includes the development of units to be used by national facilities which will make up the ENVISAT PDS network providing data archiving, off-line processing and distribution of data to users.

The contract, the largest ever signed by ESA with industry for ground segment investments, is worth some 75 million ECU; several European and Canadian companies are also associated with it, in support of Thomson-CSF, the main contractor.

A significant proportion of the development work, and most of the integration activities, are to be performed by Italian companies.

*Signing of the ENVISAT-1 Payload Data Segment Development contract. From left to right seated: ESA's Director General, Mr Jean-Marie Luton; Chairman of Thomson-CSF Services et Systèmes Sol Spatiaux, Mr Alain Delecroix. From left to right standing: Mr F. Roscian (ESRIN), Mr J Louet (ESTEC), Mr J-P Guignard (ESRIN), Mr L Marelli (ESRIN), Mr B Pfeiffer (ESTEC), Mrs E Löffler (ESRIN)*



## Space Robotics Workshop

The fourth ESA Workshop on Advanced Space Technologies for Robot Applications 'ASTRA 96' was held on 6 and 7 November 1996 at ESTEC, Noordwijk (NL), and was attended by 112 participants from European industry, research institutes and national space agencies. The objective was to provide a forum for discussion and brainstorming by of the European space Automation and Robotics (A&R) community, covering areas of A&R technology.

The workshop was structured in three main parts: an overview of potential missions and application scenarios; presentations on research and development programmes in space A&R; and a number of parallel sessions on the main technology areas.

The first part included presentations on:

- the European Robotic Arm (ERA)
- the joint ESA/ASI technology demonstration experiment JERICO
- the Russian MIR station
- possibilities for module-internal and - external A&R systems on the International Space Station
- robotised geostationary servicing vehicle concepts



- perspectives of lunar surface robotics
- scientific applications for robotic systems on planetary missions
- the potential of robotics for future science missions.

On both days of the workshop, a demonstration and exhibits session took place in the laboratories of the Automation and Ground Facilities Division (including a small Mars and Moon terrain model). Particular highlights were the various contributions, during the presentation sessions and in the lab demonstrations, on

*Demonstration of a mobile robot on a mockup of a Mars terrain.*

mobile robots, which could be of interest for sensor deployment on Moon or Mars missions.

The workshop was rated as very successful, providing an inspiring forum for the European space A&R community to exchange ideas and assess the project application potential of the latest robotic technologies.

## ESA and Matra Marconi Sign Contract for ISS Freezer

After the successful completion of several months of negotiations, the European Space Agency signed a contract with Matra Marconi Space, as the prime contractor representing a consortium including L'Air Liquide, Linde, Damec, Kayser Threde and Etel, for the development of a freezer operating at  $-80^{\circ}\text{C}$  to be used on the International Space Station.

Three freezer units will be delivered to NASA in return for early access to the Space Station by ESA. A further unit will be delivered to Japan's space agency, NASDA, in return for twelve Space Station payload mounting racks.

The contract, amounting to 22.3 MECU, was signed on 14 January 1997 at ESTEC by the Director for Manned Spaceflight



and Microgravity, ESA, Mr Jörg Feustel-Büechl and the Director of Space Transportation and Manned Spaceflight, Matra Marconi Space, Mr Claude Guionnet.

*Mr J. Feustel-Büechl (left) and Mr C. Guionnet (right) signing the ISS Freezer contract.*

## ESA Successfully Tests its ATV Rendezvous and Docking Technology on STS-80

The European Space Agency took advantage of NASA's recent Space Shuttle flight, STS-80, which ended on 7 December 1996, to test elements of the automated rendezvous and docking system that it is developing for the International Space Station.

The system will be used when ESA's Automated Transfer Vehicle (ATV), which will ferry supplies to the Station and periodically 'reboost' the Station into higher orbit, performs its rendezvous and docking with the Station. The ATV is one of the main elements that ESA is developing as part of its participation in the International Space Station. It is scheduled to be launched for the first time by Ariane 5 in March 2002.

All of the technologies and concepts used for the ATV – many of them new and leading-edge – must be demonstrated and validated before they are implemented. ESA's precursor project, called the ATV Rendezvous Pre-development (ARP), focusses on the key technologies and equipment used in the rendezvous.

During STS-80, ESA verified its absolute and relative navigation systems which are based on Global Positioning System (GPS) technology. An ESA-developed GPS receiver had been installed on the German ORFEUS SPAS satellite that was deployed by the Shuttle crew at the start of the mission. GPS data was used to determine the satellite's precise location with respect to the Shuttle.

GPS data was collected at three times: during the deployment of the satellite, during its free flight and again when it was retrieved. All three activity periods were successful and large amounts of valuable data were collected. The measurements will be compared to data gathered simultaneously by NASA's GPS receiver on the Shuttle and the Trajectory Control Sensor (TCS) in order to validate the prototype ATV relative navigation design.



*The new 1:10 scale model of the International Space Station attracts many of the young visitors to Noordwijk Space Expo, some of whom might one day find themselves working on the Station or on Station-related projects.*

## International Space Station: Scale Model Inaugurated at Noordwijk Space Expo

One year before the first element of the International Space Station is scheduled for launch into orbit, a 1:10 scale model of the station has been assembled at Noordwijk Space Expo (NSE) and will remain there on permanent exhibition.

On 21 December 1996, the model was inaugurated by the ESA Director of Manned Spaceflight and Microgravity, Mr. J. Feustel-Büechl, during a small ceremony at NSE hosted by Prof. H. Wittenberg, Chairman of the NSE Foundation, and Mr. B. van Gool, Director of NSE. The inauguration received wide coverage in the Dutch media and the model immediately became one of the major attractions for the visitors to NSE.

Noordwijk Space Expo, ESTEC's Visitor Centre in Noordwijk, The Netherlands, is open to the public six days per week. It not only attracts Dutch visitors, but also the many foreign tourists visiting the seaside resorts and tulip fields nearby.

It was the first flight demonstration in a series of three. The second and third will take place during two Shuttle-to-Mir docking missions, STS-84 in May 1997 and STS-86 in September 1997.

Matra Marconi Space (F) holds the overall responsibility for the ARP core activities, while Daimler Benz Aerospace (D) is in charge of the implementation and execution of the ARP flight demonstrations. Laben (I) developed and supplied the GPS receiver.

## The COBEAM Experiment

The space environment surrounding the Earth is becoming increasingly polluted with space debris. Since 1957, more than 3800 space launches have led to a current population of approximately 8000 trackable objects (larger than 10 cm) in near-Earth space, only 400 to 500 of which are operational spacecraft. The remainder is space debris. It is also believed that there are many many more objects in orbit that cannot be tracked operationally (up to 100 000 or more of centimetre size).

In order to describe the spatial distribution of space debris of any size, ESA has developed the MASTER model. With the help of this model, the collision risk for satellites can be calculated. This is especially important for satellites in the most crowded altitude regions, between 750 and 1500 km (e.g. ERS-1 and ERS-2), but also at an altitude where the International Space Station will be flying (400 to 500 km). MASTER is based on a population of objects which consists of the 8000 known objects and hundreds of thousands of simulated objects which are too small to be tracked regularly and maintained in a catalogue.

How accurately does the MASTER model describe the population of untrackable debris? A complete answer to this question would require a comprehensive and nearly continuous observation of space. However, point checks on the model can be made with radar observations from powerful radar stations available, for instance, at FGAN (Forschungsgesellschaft für Angewandte Naturwissenschaften) in Wachtberg-Werthhoven near Bonn. This radar system is so powerful that objects smaller than 2 cm can be detected at a distance of 1000 km. The sensitivity of the measurements increases even further if the FGAN transmitting radar is combined with a large receiving antenna. One such antenna is located only 21 km southwest of FGAN in Bad-Münstereifel-Effelsberg. It is the world's largest steerable radio antenna: the 100 m radio telescope of the Max-Planck-Institute for Radioastronomy (MPIfR). Combined, these two facilities provide a unique opportunity to test the MASTER model.

On 25-26 November 1996, a 24-hour cooperative experiment was performed whereby the FGAN L-band radar transmitted (and received) at 1.33 GHz and the MPIfR radio telescope received the echoes. Objects as small as 0.9 cm could be detected. In total, 150 GBytes of

data were collected during the 24 hour period. Detections of 67 objects were made, of which 16 were known and 51 had not previously been identified. Preliminary results from this experiment will be presented at the ESA-organised Second European Conference on Space Debris to be held in Darmstadt on 17-19 March 1997.

*The FGAN Tracking and Imaging Radar dome (left) in Wachtberg-Werthhoven, and the 100-m radio telescope dish at Bad-Münstereifel-Effelsberg, near Bonn.*



### ESA Newsletters

EARTH OBSERVATION QUARTERLY  
 NO. 54, DECEMBER 1996  
 ED. T.D. GUYENNE  
 NO CHARGE

PREPARING FOR THE FUTURE  
 VOLUME 6 NUMBER 4 (DEC. 1996)  
 ED. M. PERRY  
 NO CHARGE

REACHING FOR THE SKIES  
 NUMBER 16 (JANUARY 1997)  
 ED. T.D. GUYENNE  
 NO CHARGE

## Publications

The documents listed here have been issued since the last publications announcement in the ESA Bulletin. Requests for copies should be made in accordance with the Table and Order Form inside the back cover.

### ESA Special Publications

SPACE STATION UTILISATION:  
 PROC. SYMPOSIUM, DARMSTADT,  
 GERMANY, 20 SEPT. – 2 OCT. 1996  
 (DECEMBER 1996)  
 GUYENNE T.D. (COMPILER)  
 ESA SP-385 // XII + 676 PP  
 PRICE: 100 DFL

SUBMILLIMETRE AND FAR-INFRARED  
 SPACE INSTRUMENTATION:  
 PROC. 30TH ESLAB SYMPOSIUM, ESTEC,  
 NOORDWIJK, 24 – 26 SEPTEMBER 1996  
 (DECEMBER 1996)  
 PILBRATT G. & ROLFE E. (COMPILERS)  
 ESA SP-388// 337 PP  
 PRICE: 80 DFL

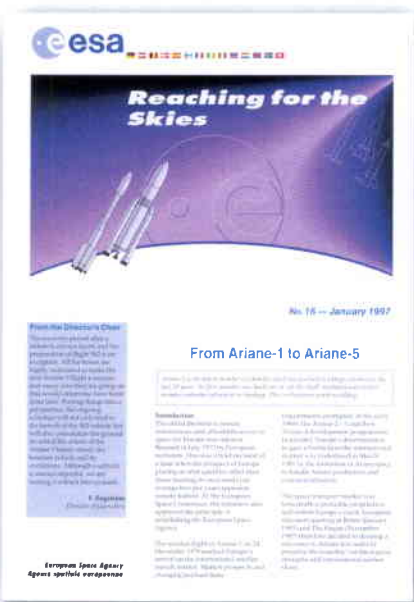
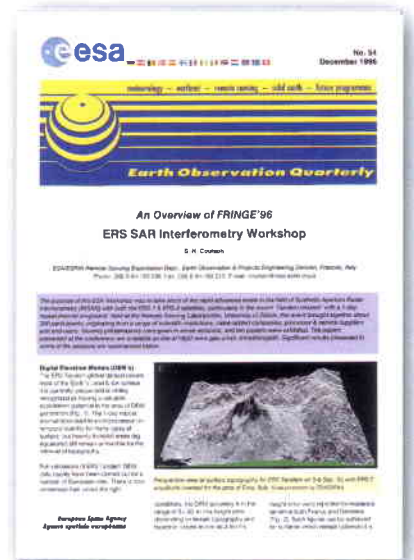

## Credit Card Payments for ESA Publications

It is now possible to purchase the Agency's publications from the ESA Publications Division 'Bookshop' using your corporate or your personal credit card (Eurocard or Mastercard).

You can telephone or telefax your orders to the numbers given below, quoting your card's number and its expiry date:

The Bookshop (attn. Mr. Frits de Zwaan)  
 ESA Publications Division  
 ESTEC  
 Keplerlaan 1  
 2200 AG Noordwijk  
 The Netherlands

Telephone: (31) 71 5653405  
 Telefax: (31) 71 5655433

Other methods of payment are also accepted. Please call or fax for details.

A list of the latest publications can be accessed via the ESA Publications Division's Home Page at the following Internet/WWW address:

<http://esapub.esrin.esa.it/esapub.html>

Printed annual Catalogues of ESA Publications are available free of charge from the Bookshop.

**ENVIRONMENT MODELLING FOR SPACE-BASED APPLICATIONS:**  
**PROC. SYMPOSIUM, ESTEC, NOORDWIJK,**  
**18 – 20 SEPTEMBER 1996**  
**(DECEMBER 1996)**

HILGERS A. & GUYENNE T.D. (COMPILERS)  
 ESA SP-392 // 364 PP  
 PRICE: 100 DFL

**SPACE MISSION OPERATIONS AND GROUND DATA SYSTEMS (SpaceOps '96):**  
**PROC. ESA/DLR SYMPOSIUM, MUNICH,**  
**16 – 20 SEPTEMBER 1996**  
**(NOVEMBER 1996)**

GUYENNE T.D. (COMPILER)  
 ESA SP-394 // 583 PP, 416 PP AND 463 PP  
 PRICE: 200 DFL (3 VOLUMES)

**SPACECRAFT GUIDANCE, NAVIGATION AND CONTROL SYSTEMS:**  
**PROC. THIRD INT. ESA CONFERENCE,**  
**ESTEC, NOORDWIJK, 25 – 28 NOV. 1996**  
**(FEBRUARY 1997)**

KALDEICH B. (COMPILER)  
 ESA SP-381 // 702 PP  
 PRICE: 100 DFL

**THE USE AND APPLICATIONS OF ERS DATA IN LATIN-AMERICA: PROC. INT. SEMINAR, VINA DEL MAR, CHILE,**  
**25 – 29 NOVEMBER 1996 (FEB. 1997)**

GUYENNE T.D. (COMPILER)  
 ESA SP-405 // 250 PP  
 PRICE: 80 DFL

**ERS SAR INTERFEROMETRY: PROC. FRINGE'96 WORKSHOP, ZURICH, SWITZERLAND, 30 SEPTEMBER – 2 OCTOBER 1996 (MARCH 1997)**

GUYENNE T.D. & DANESY D. (COMPILERS)  
 ESA SP-406 // 350 PP  
 PRICE: 80 DFL

**IMAGE PROCESSING TECHNIQUES: PROC. FIRST LATIN-AMERICAN SEMINAR ON RADAR REMOTE SENSING, BUENOS AIRES, ARGENTINA, 2 – 4 DECEMBER 1996 (FEBRUARY 1997)**

GUYENNE T.D. (COMPILER)  
 ESA SP-407 // 250 PP  
 PRICE: 80 DFL

**THE TRANSPARENT UNIVERSE: PROC. 2ND INTEGRAL WORKSHOP (MARCH 1997)**

WINKLER C. & KALDEICH B. (COMPILERS)  
 ESA SP-382 // 704PP  
 PRICE: 100 DFL

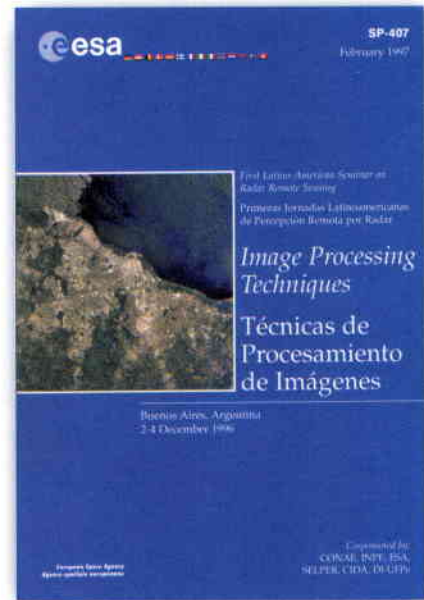
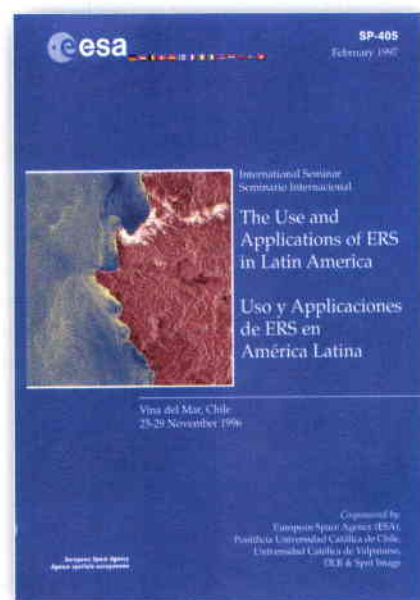
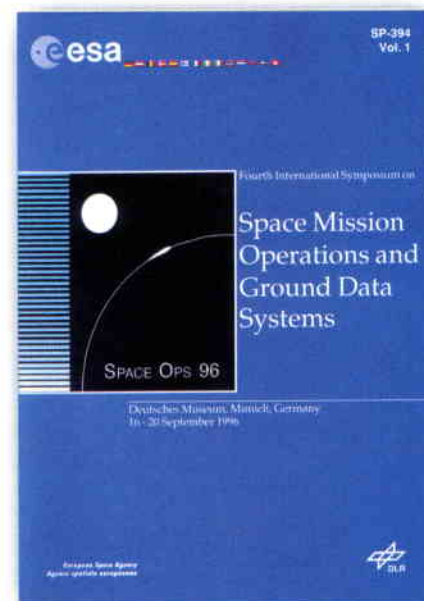
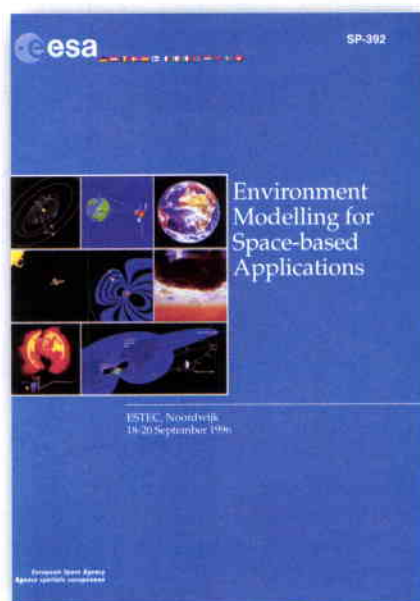
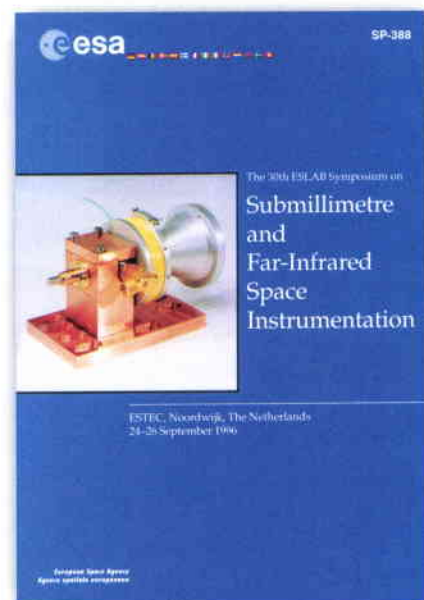
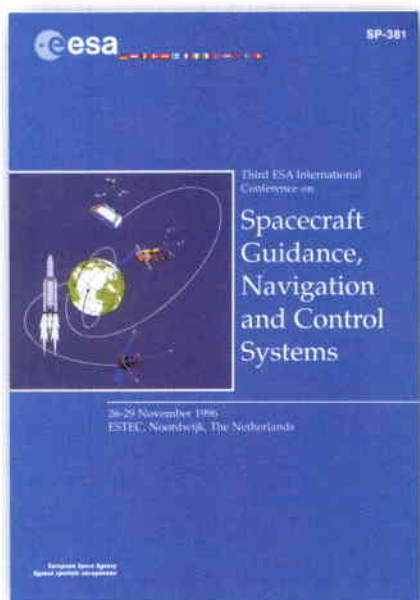

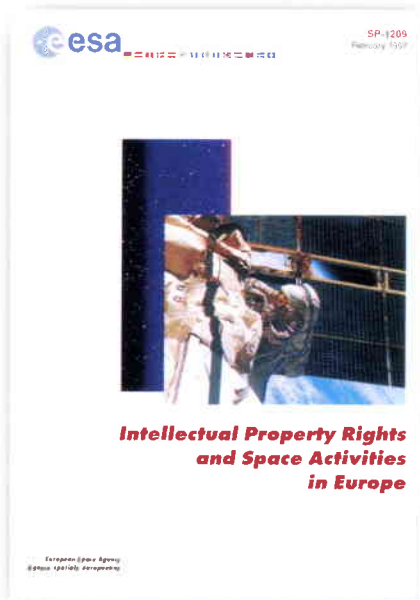
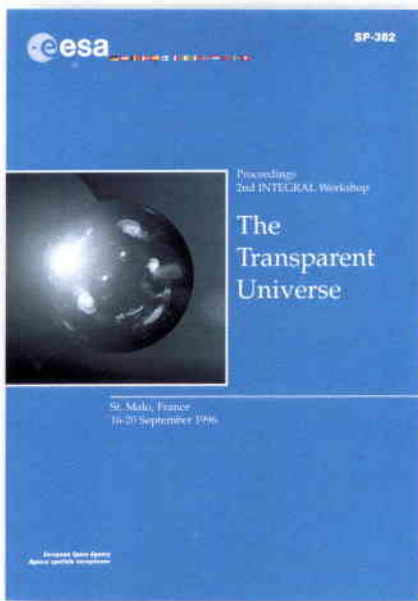

INTERNATIONAL SPACE STATION:  
ESA ANNOUNCEMENT OF OPPORTUNITY  
FOR EXTERNALLY MOUNTED PAYLOADS  
DURING THE EARLY SPACE STATION  
UTILISATION PERIOD (DECEMBER 1996)  
PETERS G. & GONFALONE A.  
(BATTRICK B. ED.)  
ESA SP-1201 // 25 PP  
PRICE: 15 DFL

ERS SPACEBORNE RADAR IMAGERY  
(FEBRUARY 1997)  
ESA/ESRIN REMOTE SENSING  
DEPARTMENT (BATTRICK B. ED.)  
ESA SP-1204 // **CD-ROM** (ONLY)  
PRICE: 50 DFL

INTELLECTUAL PROPERTY RIGHTS  
AND SPACE ACTIVITIES IN EUROPE  
(FEBRUARY 1997)  
BALSANO A.-M. & KAHN S.  
(BATTRICK B. ED.)  
ESA SP-1209 // 120 PP  
PRICE: 70 DFL

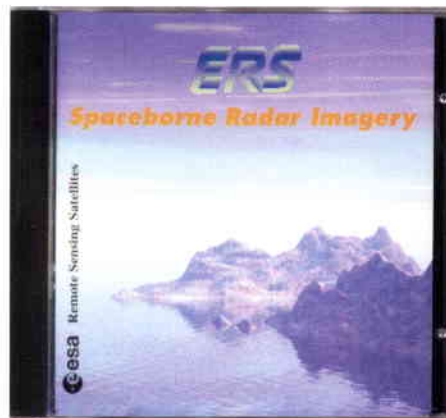

INTERNATIONAL SPACE STATION:  
RESEARCH OPPORTUNITIES IN LIFE  
SCIENCES (LIFE-SCIENCES RESEARCH  
ANNOUNCEMENT) (DECEMBER 1996)  
ELMANN-LARSEN B. (BATTRICK B. ED.)  
ESA SP-1210 // 11 PP  
PRICE: 15 DFL

### ESA Brochures

EUROMOON 2000: A PLAN FOR A  
EUROPEAN LUNAR SOUTH POLE  
EXPEDITION (DECEMBER 1996)  
OCKELS W.J. (BATTRICK B. ED.)  
ESA BR-122 // 20 PP  
PRICE: 15 DFL

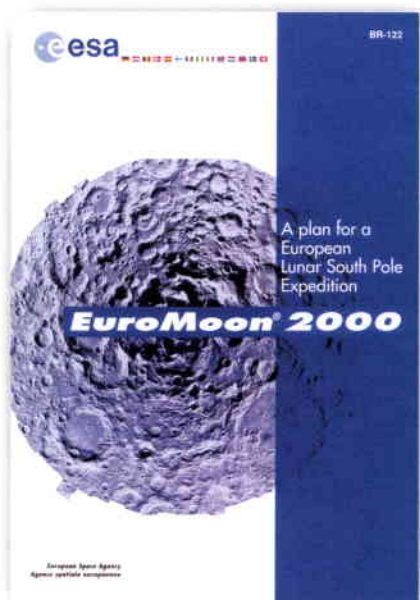
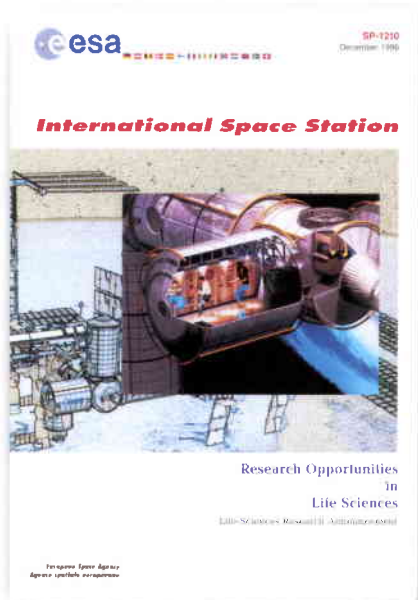

### Contractor Reports

ON-BOARD MANAGEMENT SYSTEM  
BEHAVIOURAL SIMULATION (OMBSIM)  
FINAL REPORT (5 VOLUMES)  
(FEBRUARY 1996)  
DORNIER, GERMANY  
ESA CR(P)-4005 // 53 PP, 34 PP, 59 PP, 33 PP  
AND 72 PP  
AVAIL MF

THE IMPACT OF CONTINUUM EMISSIONS  
IN THE MM AND SUB-MM SPECTRAL  
RANGE — FINAL REPORT (JUNE 1996)  
UNIV. OF BREMEN, GERMANY  
ESA CR(P)-4006 // 241 PP  
AVAIL MF

REUSABLE SOFTWARE ARCHITECTURE —  
FINAL REPORT (MAY 1996)  
CRISA, SPAIN  
ESA CR(P)-4007 // 57 PP  
AVAIL MF



**STUDY OF THE RING EFFECT**  
 – FINAL REPORT (MARCH 1996)  
 SERCO, UK  
 ESA CR(P)-4008 // 134 PP  
 AVAIL MF

**RECORD PROGRAMME PHASE 1**  
 – EXECUTIVE SUMMARY (AUG. 1996)  
 SEP, FRANCE  
 ESA CR(P)-4009 // 26 PP  
 AVAIL MF

**NAVIER-STOKES ALGORITHMS AND SOFTWARE FOR COMPUTATIONAL FLUID DYNAMICS – FINAL REPORT (AUG. 1995)**  
 VU BRUSSEL, BELGIUM  
 ESA CR(P)-4014 // 77 PP  
 AVAIL MF

**MICROGRAVITY-COMPATIBLE DRIVE – PHASE 2 (JUNE 1996)**  
 DAIMLER-BENZ AEROSPACE, GERMANY  
 ESA CR(P)-4015 // 288 PP  
 AVAIL MF

**WASTE MANAGEMENT (SEPT. 1995)**  
 AEA, UK  
 ESA CR(P)-4016 // 233 PP  
 AVAIL MF

**VERY HIGH POINTING ACCURACY AOCS – FINAL REPORT (MAY 1996)**  
 MMS-F, FRANCE  
 ESA CR(P)-4017 // 177 PP  
 AVAIL MF

**OPTIMISATION OF VISUALISATION SYSTEMS FOR MICROGRAVITY RESEARCH – EXECUTIVE SUMMARY (JANUARY 1996)**  
 ACCESS, GERMANY  
 ESA CR(P)-4018 // 16 PP  
 AVAIL MF

**FLUID-TRANSFER MANAGEMENT SYSTEM – FINAL REPORT (JUNE 1996)**  
 DAIMLER-BENZ AEROSPACE, GERMANY  
 ESA CR(P)-4019 // 68 PP  
 AVAIL MF

**MASTER PRE-PHASE-A STUDY – EXECUTIVE SUMMARY AND DATA PACKAGE (JUNE 1996)**  
 ALENIA, ITALY  
 ESA CR(P)-4020 // 921 PP AND 20 PP  
 AVAIL MF

**NAVIGATION FOR EARTH – MOON LIBRATION POINTS ORBITS (INTNAX) – FINAL REPORT (MAY 1996)**  
 GMV, SPAIN  
 ESA CR(P)-4021 // 110 PP  
 AVAIL MF

## Contractor Reports

There are two types of Contractor Reports: CR(P) and CR(X) reports.

ESA CR(P) documents are available on microfiche from either of the following addresses:

British Library — Doc. Supply Centre  
 Customer Service  
 Boston Spa  
 Wetherby, West Yorkshire  
 LS23 7BQ  
 UK

Tel: (44) 937 546 060  
 Fax: (44) 937 546 333

FIZ Karlsruhe  
 Bibliographic Service  
 D-76344 Eggenstein-Leopoldshafen  
 Germany

Tel: (49) 7247 808 333  
 Fax: (49) 7247 808 135

ESA CR(X) documents have a restricted distribution and are not available on microfiche. Printed copies can be requested via ESA Publications Division.

**BACK-UP SPACECRAFT CONTROL USING ALTERNATIVE COMMUNICATION NETWORKS (JANUARY 1996)**  
 SPACE ENGINEERING, ITALY  
 ESA CR(P)-4022 // 360 PP  
 AVAIL MF

**GEOMAGNETIC SPACE OBSERVATORIES, MISSION ARCHITECTURE CONCEPTS FINAL REPORT (JULY 1996)**  
 DANISH METEOROLOGICAL INSTITUTE  
 ESA CR(P)-4023 // 29 PP  
 AVAIL MF

**GRAVITY AND OCEAN CIRCULATION EXPLORER (GOCE) – EXECUTIVE SUMMARY (AUGUST 1996)**  
 DAIMLER-BENZ AEROSPACE, GERMANY  
 ESA CR(P)-4024 // 38 PP  
 AVAIL MF

**SOLAR ACTIVITY PREDICTION USING MODELS BASED ON SOLAR PHYSICS – EXECUTIVE SUMMARY (MAY 1996)**  
 UNIV. OF LINZ, AUSTRIA  
 ESA CR(P)-4025 // 31 PP  
 AVAIL MF

**'IMP' VERIFICATION – EXECUTIVE SUMMARY (JULY 1996)**  
 CASA, SPAIN  
 ESA CR(P)-4026 // 102 PP  
 AVAIL MF

**A PORTABLE INTELLIGENT SYSTEM FOR PROCEDURAL TRAINING – EXECUTIVE SUMMARY (SEPT. 1994)**  
 TNO-FEL, THE NETHERLANDS  
 ESA CR(P)-4028 // 20 PP  
 AVAIL MF

**AMMONIA CONTROLLED PUMP ASSEMBLY (ACPA) – FINAL REPORT (MARCH 1996)**  
 ETEL, SWITZERLAND  
 ESA CR(P)-4029 // 69 PP  
 AVAIL MF

**SAR RETRIEVAL ALGORITHMS FOR LAND APPLICATIONS – FINAL REPORT (3 VOLUMES) (NOVEMBER 1995)**  
 GEC-MARCONI, UK  
 ESA CR(P)-4030 // 15 PP, 347 PP AND 216 PP  
 AVAIL MF

**SCATTEROMETER AND RADIOMETER: LAND APPLICATIONS – EXECUTIVE SUMMARY AND FINAL REPORT (APRIL 1996)**  
 HUT, FINLAND  
 ESA CR(P)-4031 // 10 PP AND 254 PP  
 AVAIL MF

**LIMB SOUNDER PRE-PHASE-A STUDY: MASTER MILLIMETRE-WAVE ACQUISITIONS FOR STRATOSPHERIC/TROPOSPHERIC EXCHANGES RESEARCH – FINAL REPORT (3 VOLUMES) (MARCH 1996)**  
 MMS-B, UK  
 ESA CR(P)-4032 // 20 PP, 243 PP AND 579 PP  
 AVAIL MF

**DATA PACKAGING AND RETRIEVAL STUDY – FINAL REPORT (JULY 1996)**  
 LOGICA, UK  
 ESA CR(P)-4033 // 57 PP  
 AVAIL MF

STUDY OF AUTONOMOUS ORBIT AND ATTITUDE DETERMINATION TECHNIQUES FOR LOW EARTH-OBSERVATION SYSTEMS – FINAL REPORT AND EXECUTIVE SUMMARY (NOVEMBER 1995)  
GMV, SPAIN  
ESA CR(P)-4034 // 492 PP AND 37 PP  
AVAIL MF

LEDA LUNISS – EXECUTIVE SUMMARY AND FINAL REPORT (AUGUST 1996)  
ALENIA, ITALY  
ESA CR(P)-4035 // 25 PP AND 224 PP  
AVAIL MF

GRAVITY FIELD AND OCEAN CIRCULATION EXPLORER – PRE-PHASE-A STUDY FINAL REPORT (AUGUST 1996)  
ALENIA, ITALY  
ESA CR(P)-4036 // 74 PP  
AVAIL MF

A STUDY OF CLOUD DETECTION – FINAL REPORT (JULY 1996)  
SERCO, UK  
ESA CR(P)-4037 // 225 PP  
AVAIL MF

STUDY OF ECONOMIC ASPECTS OF FUTURE SPACE INITIATIVES – FINAL REPORT (MAY 1996)  
DORNIER, GERMANY  
ESA CR(P)-4038 // 184 PP  
AVAIL MF

SMART BRUSHLESS DC MOTOR – FINAL REPORT (DECEMBER 1995)  
EDEL, SWITZERLAND  
ESA CR(P)-4040 // 20 PP  
AVAIL MF

COMPUTER GRAPHICS FOR MISSION ANALYSIS – FINAL REPORT (MARCH 1996)  
DE LANDE LONG, GERMANY  
ESA CR(P)-4041 // 33 PP  
AVAIL MF

UNIVERSAL TEST BED – EXECUTIVE SUMMARY (SEPTEMBER 1996)  
MMS-F, FRANCE  
ESA CR(P)-4042 // 12 PP  
AVAIL MF

DERIVATION OF ATMOSPHERIC PROPERTIES USING A RADIO OCCULTATION TECHNIQUE – FINAL REPORT (DECEMBER 1996)  
DMI, DENMARK  
ESA CR(P)-4043 // 209 PP  
AVAIL MF

BROADBAND DUAL-POLARISED FEEDS FOR THE RADIO ASTRONOMY SATELLITE IVS – FINAL REPORT (SEPTEMBER 1996)  
CSELT, ITALY

ESA CR(P)-4044 // 269 PP  
AVAIL MF

THE EARTH-EXPLORER MISSIONS: REQUIREMENTS AND CONSTRAINTS FOR THE CANDIDATE MISSION ARCHITECTURES AND PAYLOADS (ROCMAP) – 7 VOLUMES (AUGUST 1996)  
SPACE SYSTEMS FINLAND LTD., FINLAND  
ESA CR(P)-4045 // 55 PP, 51 PP, 51 PP, 73 PP, 44 PP, 53 PP AND 11 PP  
AVAIL MF

ASSESSMENT OF THE FEASIBILITY AND USEFULNESS OF EARTH OBSERVATION BY MEANS OF SMALL SATELLITES – EXECUTIVE SUMMARY AND FINAL REPORT (APRIL 1996)  
ESYS, UK  
ESA CR(P)-4046 // 18 PP AND 210 PP  
AVAIL MF

CIGAR IV: STUDY OF ADVANCED REDUCTION METHODS FOR SPACEBORNE GRAVIMETRY DATA, AND OF DATA COMBINATION WITH GEOPHYSICAL PARAMETERS – FINAL REPORT AND EXECUTIVE SUMMARY (AUGUST 1996)  
UNIV. OF GRAZ, AUSTRIA  
ESA CR(P)-4047 // 264 PP AND 35 PP  
AVAIL MF

SPARCO – EXECUTIVE SUMMARY (MARCH 1996)  
TECHNOSPazio, ITALY  
ESA CR(P)-4048 // 35 PP  
AVAIL MF

ADVANCED SOFTWARE TOOL FOR TRAINING OF OPERATORS (ASTRO) – EXECUTIVE SUMMARY (JANUARY 1997)  
EMPRESARIOS AGRUPADOS, SPAIN  
ESA CR(P)-4049 // 28 PP  
AVAIL MF

## PUBLICATIONS OF THE EUROPEAN CENTRE FOR SPACE LAW

The following documents are also available via ESA Publications Division:

ECSL SPACE LAW AND POLICY SUMMER COURSE – BASIC MATERIALS, VOLUMES 1 AND 2 (1993)  
PRICE: 80 DFL

L'EUROPE DES TELECOMMUNICATIONS PAR SATELLITE: ENTRE LIBERALISATION ET COOPERATION (1993)  
DUCASSE E.  
PRICE: 30 DFL

THE IMPLICATIONS OF THE CEC GREEN PAPER ON SATELLITE COMMUNICATIONS IN EUROPE; PROC. ECSSL/DUTCH NPOC WORKSHOP, ESTEC, NOORDWIJK (SEPTEMBER 1991)  
PRICE: 15 DFL

NEW OPPORTUNITIES FOR COOPERATION IN EUROPEAN SPACE ACTIVITIES; PROC. ECSSL/DUTCH NPOC WORKSHOP, ESTEC, NOORDWIJK (MARCH 1993)  
PRICE: 15 DFL

INTELLECTUAL PROPERTY RIGHTS IN OUTER SPACE: STUDY FOR FIRST ECSSL/SPANISH CENTRE FOR SPACE LAW WORKSHOP, MADRID, SPAIN (MAY 1993)  
PRICE: 10 DFL

INTELLECTUAL PROPERTY RIGHTS IN OUTER SPACE; PROC. ECSSL/SPANISH CENTRE FOR SPACE LAW WORKSHOP, MADRID, SPAIN (MAY 1993)  
PRICE: 20 DFL

RECENT DEVELOPMENTS IN THE PROTECTION AND DISTRIBUTION OF REMOTE-SENSING DATA; PROC. THIRD ECSSL/DUTCH NPOC WORKSHOP, ESTEC, NOORDWIJK (APRIL 1994)  
PRICE: 10 DFL

INTELLECTUAL PROPERTY RIGHTS AND OUTER SPACE ACTIVITIES – A WORLDWIDE PERSPECTIVE; PROC. ESA/ECSSL WORKSHOP, ESA, PARIS, 5/6 DECEMBER 1994 (JAN. 1995)  
ESA SP-378 // 216 PP  
PRICE: 70 DFL

THE IMPLEMENTATION OF THE ESA CONVENTION – LESSONS FROM THE PAST; PROC. ESA/EUI INT. COLLOQUIUM, FLORENCE (OCT. 1993)  
PRICE: 80 DFL

SPACE LAW AND POLICY; PROC. 1994 ECSSL/UNIV. OF GRANADA SUMMER COURSE, GRANADA, SPAIN (SEPT. 1994)  
PRICE: 40 DFL

REGULATION OF THE GLOBAL SATELLITE NAVIGATION SYSTEM (GNSS); PROC. ESA/ECSSL CONFERENCE, ESTEC, NOORDWIJK, 14 – 15 NOVEMBER 1996.  
PRICE: 25 DFL

# RENDEZVOUS WITH THE NEW MILLENNIUM

## The Report of ESA's Long-Term Space Policy Committee

With 30 years of space activities behind us, we can now look forward to the next millennium on far more solid ground than the early pioneers ... At present, most space activities go from study phase to launch in about 10 years. The near-future is therefore already accounted for, and the major options for the next 20 years are also known. But what about the decades beyond that, and how will the world change over the next 50 years?

To identify a strategic vision for European space activities in the next century — one that will respond both to the challenges and threats facing humanity in the future — the ESA Council created a Long-Term Space Policy Committee (LSPC) in June 1993. The Committee's task was to prepare a report on European space policy after the year 2000.

The LSPC chose to take a 50-year perspective in order to go beyond the mere extrapolation of current trends while still keeping in mind the present technological and financial constraints. The Committee analysed in depth the themes that it deemed to be of importance and collected the thoughts of recognised experts in relevant domains.

Its work has culminated in this report, *Rendezvous with the New Millennium*, which was presented to the ESA Council Meeting at Ministerial Level in Toulouse in October. The Ministers welcomed and endorsed the report: they expressed their satisfaction with the perspectives taken and have invited the Committee to continue to reflect on the long-term space policy for Europe.

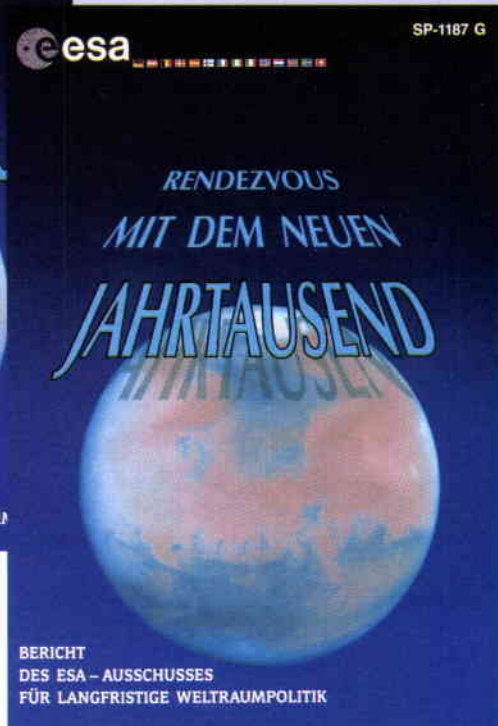
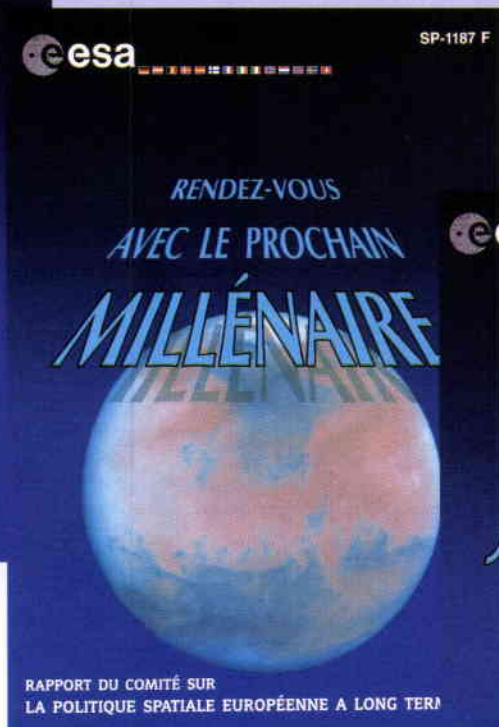
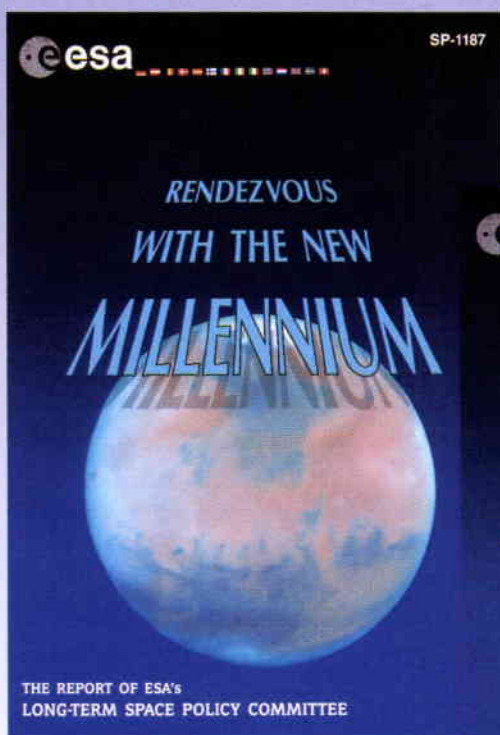

Available in  
English, French and German.

To order:  
Send a cheque or international  
banker's draft (made payable to 'ESA Publications Division') to:

ESA Publications Division  
ESTEC  
Postbus 299  
2200 AG Noordwijk  
The Netherlands

Price: 35 Dutch guilders (or the equivalent in another currency)

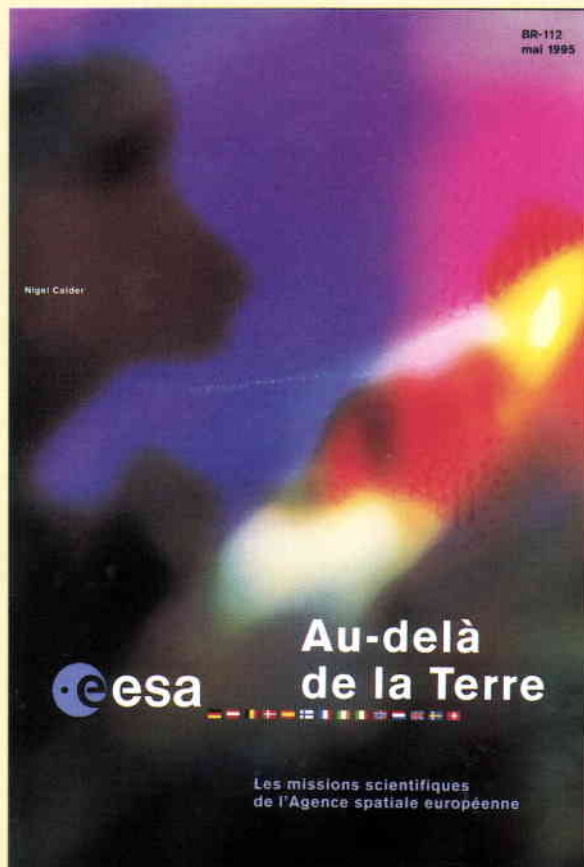

## Au-delà de la Terre

Les missions scientifiques de  
l'Agence spatiale européenne (ESA)  
de Nigel Calder

*'Au-delà de notre ciel teinté de bleu par l'atmosphère terrestre s'étend l'Univers, ce vide spatial noir ponctué de planètes, d'étoiles et de galaxies. C'est le royaume des chercheurs spatiaux.'*

Nigel Calder, écrivain très connu en Grande-Bretagne pour la qualité de ses écrits scientifiques, brosse ici un tableau complet et vivant du programme de recherche spatiale de l'ESA, en nous donnant un avant-goût des projets que l'Agence compte mettre en oeuvre au XXI<sup>e</sup> siècle.

La vigueur et la diversité de cette recherche s'imposent au lecteur. *Au-delà de la Terre* présente douze missions différentes, en mettant l'accent sur les raisons humaines et scientifiques qui sous-tendent l'immense travail à la clé de la

recherche spatiale. La description proprement dite des missions est accompagnée de détails techniques apparaissant sous forme de tableaux et d'illustrations.

Cet ouvrage traite principalement du programme scientifique actuel de l'Agence : Horizon 2000. Les quatre grandes missions dites pierres angulaires — Soho et Cluster, XMM, Rosetta, First — ainsi que les différentes missions de taille moyenne y sont exposées. La première partie du document porte sur les engins spatiaux chargés d'explorer les environs de la Terre, le Soleil et d'autres destinations du système solaire, la deuxième étant consacrée aux télescopes d'astronomie sur orbite terrestre. Dans l'un et l'autre cas, l'auteur donne un aperçu du contexte historique et international dans lequel s'inscrivent les missions.

La troisième partie du document projette le lecteur dans la deuxième décennie du XXI<sup>e</sup> siècle et traite plus particulièrement des trois grandes missions du programme Horizon 2000 Plus de l'ESA, qui couvre la période 2006-2016. Explorer la mystérieuse planète Mercure, exploiter les avantages de l'interférométrie pour atteindre un degré de précision inégalé dans le domaine de l'observation astronomique, partir à la recherche des ondes gravitationnelles — tels sont les trois projets majeurs de l'Agence pour cette période, conciliant les nécessités de la planification à long terme et le caractère imprévisible de la recherche.

Document disponible  
auprès de:

ESA/Division des Publications  
ESTEC  
Postbus 299  
2200 AG Noordwijk  
Pays-Bas

Prix: 35 florins  
(ou l'équivalent dans une  
autre monnaie, à régler soit  
en espèces soit par chèque  
libellé à l'ordre de  
'ESA Publications Divisions')

Fax : (31)71.565.5433

# Publications Available from ESA Publications Division

Publication	Number of issues per year	Scope/Contents	Price	Source
<b>Periodicals</b>				
ESA Bulletin	4	ESA's primary magazine	Free of charge	ESA Publications Division, c/o ESTEC, 2200 AG Noordwijk, The Netherlands
Earth Observation Quarterly	4	Remote-sensing news	..	..
ECSL News	4	News from the European Centre for Space Law (under the auspices of ESA)	..	..
Reaching for the Skies	4	ESA's Space Transportation Systems news	..	..
Microgravity News	3	Microgravity Programme news	..	..
Preparing for the Future	4	Technology Programme news	..	..
<b>Monographs</b>				
	<b>Code</b>			
Conference Proceedings	(SP-xxx)	Collection of papers presented at an ESA conference	Prices vary	ESA Publications Division, c/o ESTEC, 2200 AG Noordwijk, The Netherlands
Special Publications	(SP-xxxx)	Detailed monographs on post-graduate level subjects	..	..
Brochures	(BR-xxx)	Concise summaries on specific subjects	..	..
Scientific & Technical Reports	(STR-xxx)	Graduate level — reflecting ESA's position on a given subject	..	..
Scientific & Technical Memoranda	(STM-xxx)	Graduate level — latest but not finalised thinking on a given subject	..	..
Procedures, Standards & Specifications	(PSS-xxx)	Definitive requirements in support of contracts	..	..
Training Manuals	(TM-xxx)	Series for education of users or potential users of ESA programmes, services or facilities	..	..
<b>Public-relations material</b>		General literature, posters, photographs, films, etc.		ESA Public Relations Service 8-10 rue Mario-Nikis 75738 Paris 15, France

All periodicals are also available via the Internet at:

<http://esapub.esrin.esa.it/esapub.html>

Selected public-relations material and other ESA information is available at:

<http://www.esrin.esa.it>

# Order Form for ESA Publications

**IMPORTANT**

1. For credit-card orders, see page 114.
2. Orders must be accompanied by a Cheque or International Banker's Draft, in Dutch Guilders, made payable to 'ESA Publications Division'. No publications will be sent before receipt of payment.
3. Within Europe, mailing is free-of-charge. Outside Europe, airmail is free-of-charge for orders over Dfl. 110; smaller orders are sent sea mail.

**RETURN TO: FINANCE DIVISION (EFA/P)  
ESTEC, POSTBUS 299  
2200 AG NOORDWIJK  
THE NETHERLANDS**

No. of copies	ESA reference	Title	Price per copy, Dfl.	Total Dfl.

Total:

Discount for orders over Dfl. 110: 10% of total : .....

Total amount enclosed: .....

**MAILING ADDRESS (Please print carefully)**

Name .....

Function .....

Organisation .....

Mailing Address .....

.....

Town & Postal Code .....

Country .....

Date..... Signature.....

**METHOD OF PAYMENT (Please tick box)**

Cheque

International Banker's Draft

} enclosed, made payable to ESA Publications Division.

# ADVERTISE YOUR SPACE-RELATED PRODUCTS/SERVICES IN

# esa bulletin

## Mechanical requirements — Copy dates

Printing material:	1 positive offset film (right reading, emulsion side down).	
Usable material:	Negative, artwork ready for reproduction. All production charges are invoiced separately.	
Copy date:	Ready for printing: 30 days before publication	
(in Noordwijk)	Any difficulty in observing these deadlines after reservation should be notified immediately tel. (31) (0)71-5653794 fax (31) (0)71-5655433	
Type area:	1/1 page	185/265 mm high
	1/2 page horizontal	185/131 mm high
	1/4 page vertical	91/131 mm high
	1/4 page horizontal	185/ 65 mm high
Screen:	60/cm — 150/inch	
Page size:	297mm x 210mm	
Bleed amount:	3mm	

## Issue dates

ESA Bulletin: February, May, August and November

## Rates in Dutch Guilders

	1 x	4 x	8 x
1/1 page B/W	2.000.—	1.600.—	1.200.—
1/2 page B/W	1.200.—	1.000.—	800.—
1/4 page B/W	800.—	700.—	600.—

Extra charge for 4 colour processing: 1.500.— Dutch Guilders.  
Loose inserts (by application only) 1/A4, Dfl. 3.000.— plus Dfl. 129.— per thousand bookbinder's handling charge

## Circulation

Albania	Honduras	Sao Tome & Principe
Algeria	Hong Kong	Saudi Arabia
Andorra	Hungary	Senegal
Argentina	Iceland	Serbia
Australia	India	Singapore
Austria	Indonesia	Slovakia
Bahrain	Iran	Slovenia
Bangladesh	Iraq	South Africa
Barbados	Ireland	Spain
Belgium	Israel	Sri Lanka
Belize	Italy	Sudan
Benin	Ivory Coast	Surinam
Bhutan	Jamaica	Swaziland
Bolivia	Japan	Sweden
Bosnia and Herzegovina	Jordan	Switzerland
Botswana	Kenya	Syria
Brazil	Korea	Tahiti
Bulgaria	Kuwait	Taiwan
Burkina Faso	Latvia	Tanzania
(Upper Volta)	Lebanon	Thailand
Burma	Liechtenstein	Togo
Burundi	Libya	Trinidad and Tobago
Cameroon	Lithuania	Tunisia
Canada	Luxembourg	Turkey
Chile	Macedonia	Uganda
China	Madagascar	UAE
Colombia	Mali	United Kingdom
Commonwealth of Independent States	Malta	Uruguay
Congo	Mauritania	USA
Costa Rica	Mauritius	Venezuela
Croatia	Mexico	Vietnam
Cuba	Monaco	Yemen
Cyprus	Mongolia	Zaire
Czech Republic	Montenegro	Zambia
Denmark	Morocco	Zimbabwe
Dominican Republic	Mozambique	
Dubai	Nepal	
Ecuador	Netherlands	
Egypt	Netherlands Antilles	
El Salvador	New Caledonia	
Estonia	New Zealand	
Ethiopia	Nicaragua	
Faroe Islands	Niger	
Fiji	Nigeria	
Finland	Norway/Pakistan	
France	Papua New Guinea	
French Guiana	Peru	
Gabon	Philippines	
Gambia	Poland	
Germany	Portugal	
Ghana	Puerto Rico	
Gibraltar	Qatar	
Greece	Romania	
Guatemala	Rwanda	

## Advertising Management

Brigitte Kaldeich  
ESA Publications Division  
ESTEC, Keplerlaan 1  
2200 AG Noordwijk, The Netherlands  
Tel. (31) (0) 71 5653794  
Fax (31) (0) 71 5655433

**Member States**

Austria  
Belgium  
Denmark  
Finland  
France  
Germany  
Ireland  
Italy  
Netherlands  
Norway  
Spain  
Sweden  
Switzerland  
United Kingdom

**Etats membres**

Allemagne  
Autriche  
Belgique  
Danemark  
Espagne  
Finlande  
France  
Irlande  
Italie  
Norvège  
Pays-Bas  
Royaume-Uni  
Suède  
Suisse

**European Space Agency**  
**Agence spatiale européenne**

*Contact: ESA Publications Division*

c/o ESTEC, PO Box 299, 2200 AG Noordwijk, The Netherlands  
Tel (31) 71 565 3400 - Fax (31) 71 565 5433

Visit ESA Publications at: <http://esapub.esrin.esa.it/esapub.html>