

F. SHUMAN & C. V. BOYS.  
 SUN BOILER.  
 APPLICATION FILED SEPT. 30, 1912.

1,240,890.

Patented Sept. 25, 1917.  
 4 SHEETS—SHEET 1.

Fig. 1.

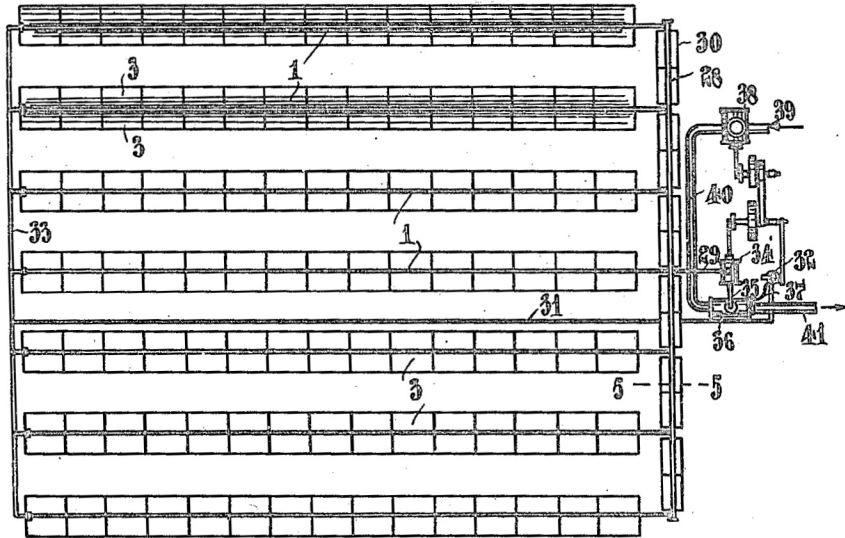

Fig. 2.

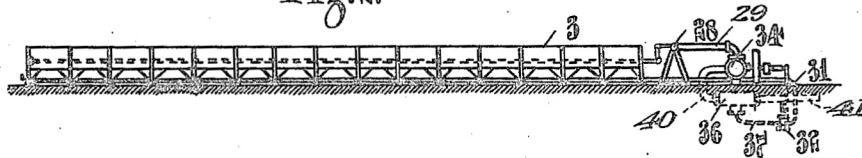

Fig. 4.

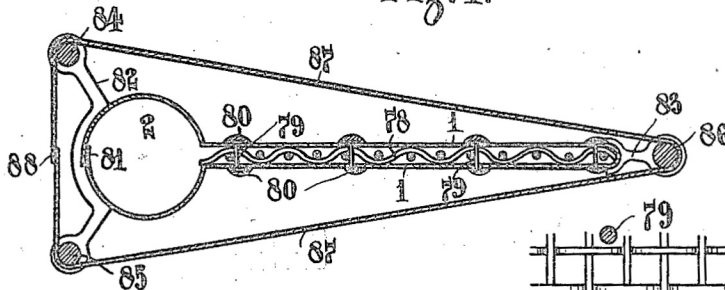
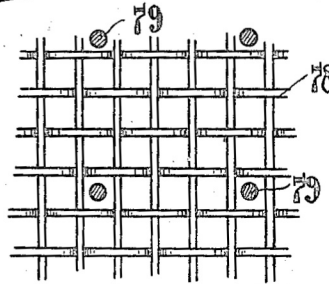

Fig. 4<sup>a</sup>.



Witnesses  
 Elsie Fullerton  
 Hamilton D. Turner

Inventors  
 Frank Shuman  
 Charles Vernon Boys  
 by Harry Smith  
 Attorney

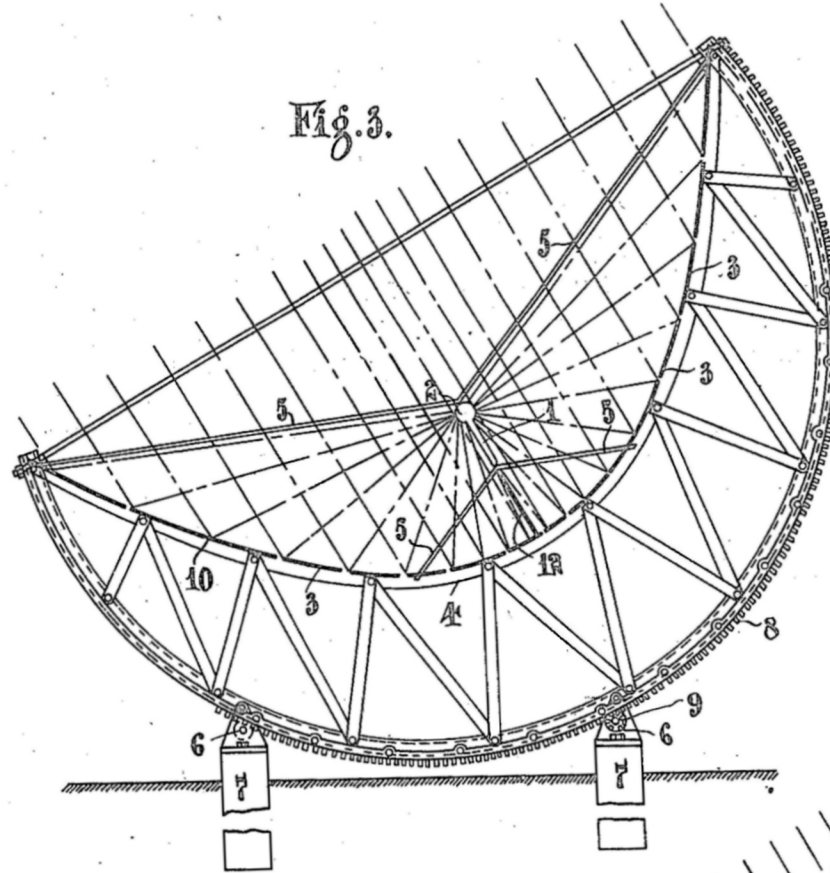

Fig. 6.

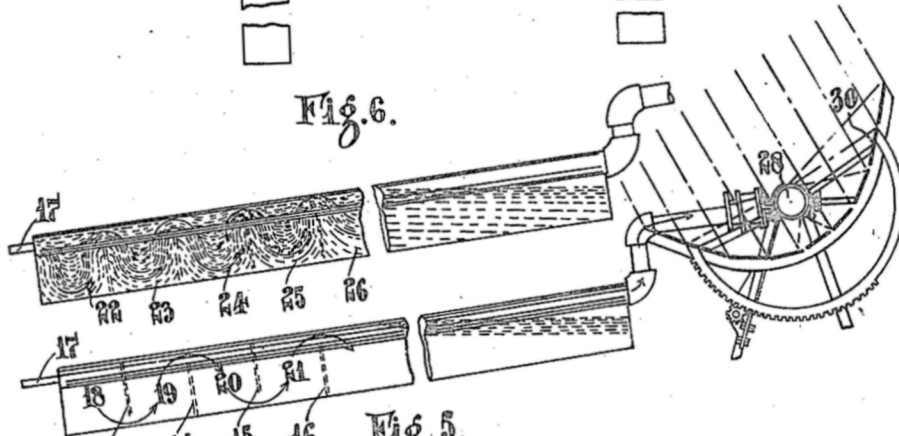
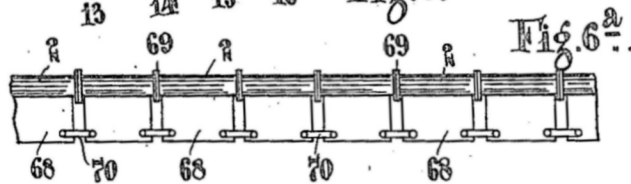

Fig. 5.



Witnesses  
 Elsie Fullerton  
 Hamilton S. Turner

Inventors  
 Frank Shuman  
 Charles Vernon Boys  
 by Harry Smith  
 Attorney

F. SHUMAN & C. V. BOYS.  
 SUN BOILER.  
 APPLICATION FILED SEPT. 30, 1912.

1,240,890.

Patented Sept. 25, 1917.  
 4 SHEETS—SHEET 3.

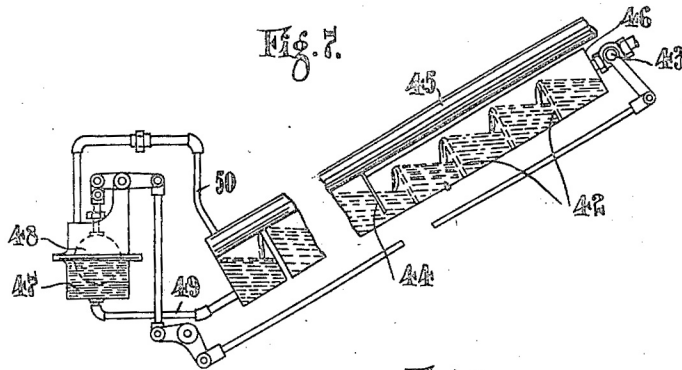

Fig. 8.

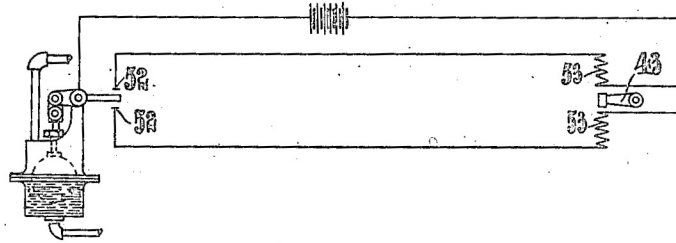
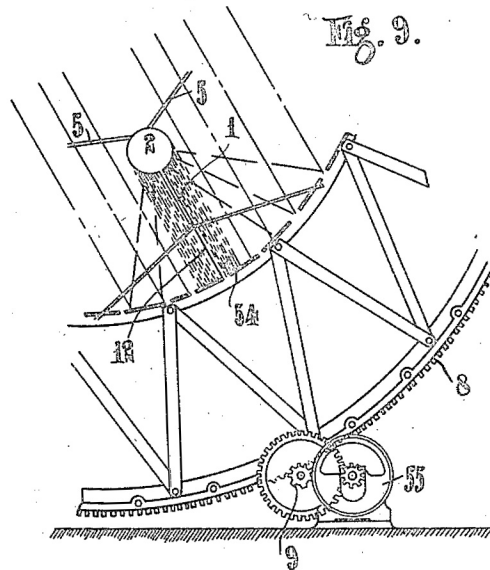

Fig. 9.



Witnesses  
 Elsie Fullerton  
 Hamilton Turner

Inventors  
 Frank Shuman  
 Charles Vernon Boys  
 by Harry Smith  
 Attorney

F. SHUMAN & C. V. BOYS.  
 SUN BOILER.  
 APPLICATION FILED SEPT. 30, 1912.

1,240,890.

Patented Sept. 25, 1917.  
 4 SHEETS—SHEET 4.

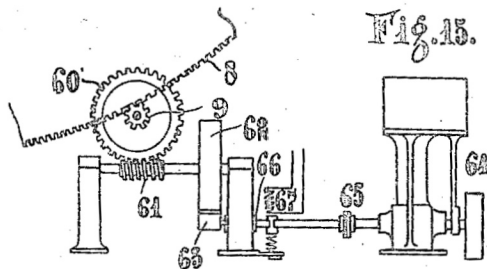
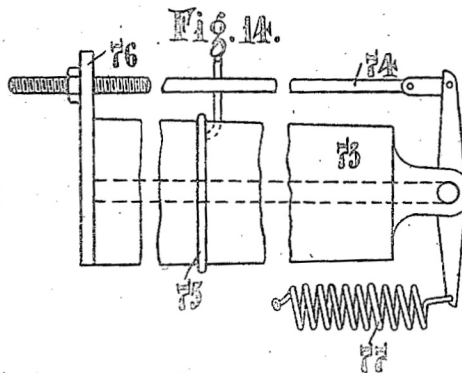
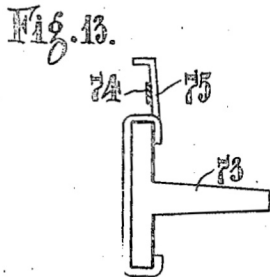
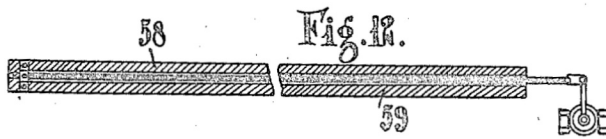
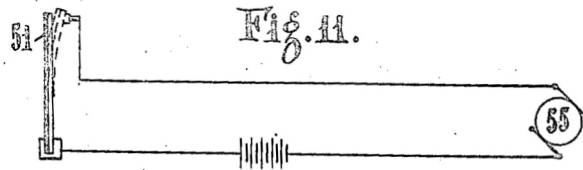
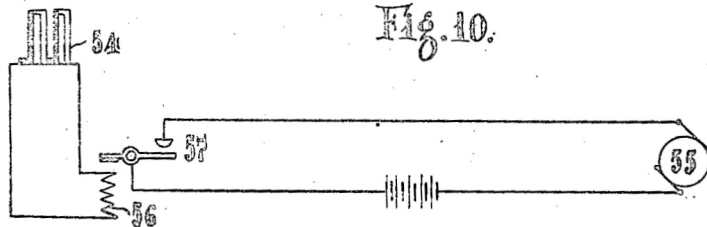

Witnesses  
 Elsie Fullerton  
 Hamilton S. Turner

Inventors  
 Frank Shuman  
 Charles Vernon Boys  
 by Harry Smith  
 Attorney

# UNITED STATES PATENT OFFICE.

FRANK SHUMAN, OF PHILADELPHIA, PENNSYLVANIA, AND CHARLES VERNON BOYS,  
OF WESTMINSTER, LONDON, ENGLAND.

## SUN-BOILER.

1,240,890.

Specification of Letters Patent. Patented Sept. 25, 1917.

Application filed September 30, 1912. Serial No. 723,209.

*To all whom it may concern:*

Be it known that we, FRANK SHUMAN, a citizen of the United States of America, residing at Tacony, Philadelphia, State of Pennsylvania, in the United States of America, and CHARLES VERNON BOYS, F. R. S., a subject of the King of England, residing at Westminster, London, in England, have invented certain new and useful Improvements in and Relating to Sun-Boilers, of which the following is a specification.

Many attempts have been made to utilize the radiation from the sun for heating boilers. Large parabolic reflectors have been used to concentrate the radiation upon a small boiler placed at the focus, but the first cost of the reflectors, the difficulty of connecting a large number of boilers and of following the sun in its apparent motion have prevented these from being used successfully for large powers.

Further the difficulty of efficient concentration of the heat rays on small boilers or the large amount of water to be heated before any steam is available if the boilers are large compared with the mirrors have rendered many previous attempts practically useless.

In other forms of heaters in which the boiler is made with a flat, or substantially flat surface of considerable extent to be exposed to the direct or reflected sun's rays or both, it has been found necessary to provide heat insulation for the rear or under side of the boiler. This not only detracts from the available area of possible heating surface, but is also a source of expense. Moreover such insulation cannot be wholly efficient; whether of inorganic or organic material it will suffer a certain quantity of heat to escape, and if of organic material it is liable to destruction by organic change or by the ravages of white ants and other forms of life.

Boilers that are flat and horizontal, or of which the surface is disposed transversely to the path of the sun's rays and therefore at small angle to the horizon, when the sun is high in tropical countries, are liable to a deposit of dust which greatly reduces the efficiency otherwise available.

Now it is the object of our invention to construct and mount the boilers and reflectors so that the above difficulties and disadvantages are obviated, or at least greatly reduced, and further to provide a heater of a practical character suitable for employment under the conditions in which such heaters will usually be required to be used.

Figure 1 is a plan view and Fig. 2 is a front elevation of a group of boilers united to a steam pipe, an engine and other auxiliary apparatus, the whole forming a complete sun-power plant.

Fig. 3 is a section on line 3—3 (on a larger scale) showing one of the boilers with its reflectors and means of suspension and of movement.

Fig. 4 illustrates the construction of the boiler in cross section and sheets of transparent ordinary celluloid or transparent unflammable celluloid or other similar material is used for arresting radiation from the boiler.

Fig. 4<sup>a</sup> illustrates a piece of corrugated woven wire mesh used in the construction of boiler shown in Fig. 4.

Fig. 5 is a section on line 5—5 (also on a larger scale) illustrating a reflector for the steam pipe and a method of constructing the boiler for the better heating of the water introduced therein.

Fig. 6 is a section showing a modification of Fig. 5.

Fig. 6<sup>a</sup> illustrates a further modification of the construction of the boiler.

Fig. 7 is a sectional view illustrating a construction of boiler for use where the ground is inclined.

Fig. 8 illustrates an electric control for the feed water of the boiler shown in Fig. 7.

Fig. 9 illustrates an electrical apparatus for moving the boilers and mirrors for heliostatic purposes.

Figs. 10 to 14 illustrate automatic thermostatic devices for use therewith.

Fig. 15 illustrates a modification of the heliostatic apparatus.

Our invention principally consists in a construction of boiler and reflector, the boiler being substantially in the form of a long, thin, flat body as shown at 1, having a

widened head 2 to serve as a steam pipe, and placed edgewise to the sun, the reflector consisting of a number of strips of mirror 3 on each side of the boiler 1 so that the rays of the sun may be reflected and concentrated on to both faces of the boiler.

The boiler 1 is constructed out of thin sheet metal, sheet iron coated with lead being preferably used. Within the boiler is a sheet of woven wire mesh or suitably perforated sheet metal 78 which is corrugated either vertically or horizontally. The outer sheet metal is preferably flat but may if desired be corrugated, the corrugations of the outer sheet metal and of the inner wire mesh then crossing one another. The two outer faces are secured to one another at intervals by driving a nail 79 preferably lead coated, through the two plates and through the intervening corrugated wire mesh, and turning over the projecting point of the nail. A covering of lead or other solder 80 is placed about the head and point of each nail. The plates are rolled outward at the upper end to form the enlarged head 2 and are suitably connected together as at 81.

82, 83, indicate suitable spiders which carry rods 84, 85, 86, a sheet or sheets of ordinary or of unflammable transparent celluloid 87 being wrapped about the whole and secured as at 88.

In order to reduce the loss of heat from the solar boiler by conduction and convection, the boiler is preferably coated with a transparent varnish or enamel. It is preferable first to coat the boiler with a dull black paint before applying the varnish or enamel. But if the boiler is made of leaded irons or of other metal which can be turned black by a chemical treatment such as for instance the treatment of lead with sulfureted hydrogen then we prefer to do this, and the coating with a dull black paint is not needed.

The invention further consists in mounting such a boiler and its mirrors so that they are movable together as a whole to follow the position of the sun.

The interconnection of the boiler 1 and mirror system 3 may be carried out by the use of light crescent-shaped lattice or other frames 4 arranged at intervals and parallel to one another, of such form as to support the mirrors 3 correctly and with suspension wires 5 to carry the boiler 1 in fixed relation to the mirrors 3 so that when the series of frames 4, which are supported on rollers 6 on a series of fixed standards 7, are tilted by means of rack and pinion gear 8, 9, or other inexpensive gear, so as to bring the boiler 1 edgewise to the sun, the mirrors 3 may at the same time move with the boiler so as to maintain the radiation upon its faces.

We prefer to leave narrow spaces as at 10 between the adjacent edges of the mir-

rors 3 so that studs attached to the frames and carrying holding down buttons may pass between them and so that dust resting on the mirrors 3 may fall through under the action of the wind or when dusted.

A partition 12 runs from the center line of the mirrors to the bottom of the boiler to prevent wind from blowing through underneath the boiler and to confine the air under the boiler while in a tilted position by which means much loss of heat is avoided.

In constructing a long boiler, it is important that the top and bottom should not be unequally heated. If the comparatively cool water from the condenser, for instance is merely allowed to run into the bottom of the boiler, it will flow along the bottom of the boiler, and that part of the boiler will remain cooler than the top where the water is at the boiling point, and where there is steam at higher temperatures. In any very long boiler this would immediately result in twisting the entire boiler out of shape. This difficulty we overcome by the use of partitions 13, 14, 15, 16, Fig. 5, which divide the left hand and lower end of the boiler into a number of spaces for example, four in number. The cool water enters through pipe 17, and enters the space 18 which is cut off from the rest of the boiler everywhere except at the extreme bottom of partition 13 where the water can pass through as shown by the arrow, into space 19. The water then rises, due to absorption of heat, and passes over the top of partition 14, into the space 20 whence it passes under the bottom of the partition 15 into the space 21, then over the top of the partition 16, into the main body of the boiler.

In Fig. 6 is shown a modification of this idea. The cool water comes in through the pipe 17, drops, due to its greater density, toward the bottom of the first space 22, then as it receives heat from the sun, it again rises and drops into the second space 23 where again it goes near to the bottom due to its greater density, and this recurs from space to space 24, 25 until by the time the water has reached the space 26 it is up to the boiling point.

In the modification of the boiler shown in Fig. 6<sup>a</sup>, a suitable number of separate lengths or sections 68 are used connected together along their upper edge by their enlarged heads 2 which form a pipe common to them all. The ends of the enlarged heads may be provided with flanges 69 for connection of each to the next. Such boiler may be used as in Figs. 5 and 6 or may be placed horizontally in which case U shaped connecting pipes 70 may also be used for passage of water from each to the next.

A number of these combined boiler and mirror structures may be connected in a series or range of any desired length. The

steam passes from one to another of such series of boilers by the aid of connecting pipes. There may be as many of these ranges as are needed, seven being shown for example in Fig. 1.

5 The steam outlet from each range of boilers runs into the main steam pipe 28.

29 is the connection from the main steam pipe to the engine 34.

10 This main steam pipe 28 is surrounded with a superheater consisting of mirrors 30, of the same general construction as the mirrors of the main heat absorber and not only prevent loss of heat from the steam pipe, but actually raise the temperature of the steam or superheating it to a considerable extent above that obtained in the heat absorber proper

20 31 is the water feed pipe running from the wet vacuum pump 32 to the branch line 33, which divides the water evenly between the seven banks of boilers. This water is the condensed steam that has passed through the engine 34.

25 35 is the exhaust pipe from engine to condenser 36.

37 is the water feed pipe from the condenser 36 to the wet vacuum pump 32.

30 38 is an irrigation pump, the suction pipe 39 of which runs either to a river or to wells, or to other sources of water, and the discharge pipe 40 runs to one end of the condenser.

35 The whole quantity of water discharged by the irrigation pump 38 flows through the condenser 36 and from the other side of the condenser flows on to the land which is to be irrigated, or to the reservoir through a pipe 41. This large quantity of water is only heated a fraction of a degree Fahrenheit in condensing the steam, and is not spoiled for irrigation or other purposes.

45 Fig. 7 shows a general view of one bank of heat absorbers for use on inclined ground, the view being broken in the middle, being much longer in reality. The thin portion of the boiler is divided at intervals of say 3 ft. with the partitions 42, or is made in sections as described with reference to Fig. 6<sup>a</sup>.

50 The water enters at the higher end, through the valve 43, into the first compartment until it has become filled to the overflow point, when the water cascades into the second compartment, and so on down the line until

55 it comes to the water seal shown at 44.

This water seal 44 drops down into the water, so as to prevent the already formed steam in the boiler from getting into the first partitions to the right, where it would immediately condense and lose greatly in volume.

65 In order to prevent further the contact of the steam with the cool incoming water, it will be seen that the steam pipe 45 is separated from the thin part of the heater 46,

in other words, the steam pipe from the water seal 44 upward becomes separate from the boiler.

In the manner shown, the steam pipe is kept free of water throughout its entire length, and steam can easily escape through- 70 the entire length of the boiler.

If the water in the lower compartment is kept always at the proper level the water in all of the other compartments must also be 75 at the proper level.

There is, therefore, in communication with the lower left hand space, a float box 47, containing a float 48 which regulates the level of the water in this lowest compartment as 80 follows:—

The water from the lowest partition enters the float box 47 through a pipe 49, the pipe 50 is connected with the steam pipe so as to equalize the pressure on the two 85 sides. As the float ball rises or falls the lever of the valve 43 which controls the inlet of the water is opened or shut, either turning on more water in case the level falls too low, or shutting off more water in case 90 the level rises too high. By this means the water is automatically retained at the proper level in each particular bank of heat absorbers; consequently it only becomes necessary for the wet vacuum pump to pump the 95 water to the highest point, and thereafter the mechanism will automatically regulate the depth in each particular bank of heat absorbers.

The mechanical communication of the 100 movement of the float 48, to the valve 43 can be done in various ways. In Fig. 8 is shown an electrical device for accomplishing this purpose, the float lever comes in contact with either one of the contact plates marked 52 105 which establishes a circuit controlling small electro-magnets 53, which will pull the lever of the valve 43, either way, thus either shutting off the water or turning it on.

To cause the heat absorber to face the sun 110 by means of the action of the sun itself, there is placed in the center of the parabola of the mirrors, the thermo-pile 54 (Figs. 9 and 10). As long as this thermo-pile 54 remains in the shadow of the boiler, the motor 115 55 does not turn; but as soon as the rays of the sun (due to the rotation of the earth) impinge upon the thermo-pile a small electric current is generated, which by means of the electro-magnet 56 at once closes the circuit 57, by the aid of a relay if necessary and the motor 55 starts and turns the entire framework of the mirrors and boiler until the thermo-pile is again in the shadow of the boiler, when the motion stops. 125

It is however preferable to permit the motor to turn continually at a speed which closely approximates to the movement desired, so that the motor will keep the axes of the parabola constantly properly directed 130

to the sun. When the motor is not quite able to do this, the thermo-pile will come into action, and cause the motor to speed up for a few seconds to such a point that it will overtake the sun.

In case steam or other fluid motors are used, instead of an electric motor, instead of turning off and on the current, as in case of the electric motor, the valve controlling the pressure fluid, is opened or shut more or less by the action of the thermo-pile, as shown for instance in Fig. 12, and thus the speed of the turning of the heat absorber is accelerated until it has caught up and overtaken the sun.

Instead of a thermo-pile, a thermostat 51 as in Fig. 11 may be used. In this case the result is similar.

In Fig. 12 is shown a direct method for controlling the movement of the sun absorber. This shows a box 58 or plate made of wood, or of such a material as "invar", which neither expands nor contracts with the heat. In this box is put the rod 59 composed of a metal having a high coefficient of expansion and contraction such as zinc or aluminium. This rod may run the entire length of the heat absorber.

This would mean that when this rod, which is painted black, is exposed to the rays of the sun, due to the rotation of the earth, it would expand sufficiently to turn any kind of a valve of any desired motor. Instead of the rod there could be used a flat band of metal. In either case, the results would be the same. The moment the rod goes into shadow, it contracts, and closes the valve partly, when it is exposed to the sun it expands and opens the valve.

Fig. 13 is a section and Fig. 14 a plan of another method. 73 is a T-shaped bar of iron by which a strip of steel 74 is supported at intervals by wire fingers 75. One end of the strip 74 is adjustably secured to a bracket 76 and the other end is attached to operate the valve or other device intended to be set in action when the sun's rays shine on the strip 74, the T-bar being kept in shadow. 77 is a spring to maintain the strip 74 taut.

The strip 74 may be painted black.

This feature of our invention contemplates the use of a device which expands and contracts in conformity with variations in the shade temperature and thus neutralizes the effect of changes of temperature between morning and noon or summer and winter in the shade.

Fig. 15 illustrates another means of controlling the movement of the heat absorber. 8 is the rack on the heater frame, which is moved by the pinion 9, worm gear 60 and worm 61, the latter mounted on a shaft with the friction wheel 62. The small friction wheel 63 is mounted on the end of the shaft

of a motor 64 which may be of any desired type. The flexible coupling 65 and the bearing 66 are so arranged that the wheel 63 may be moved into contact with 62. 67 is an electro-magnet or solenoid arranged to cause contact between the friction wheels 62 and 63 at which time the heat absorber will be moved in proportion to the speed of the motor, which exceeds the speed equivalent to that of rotation of the earth. A spring is provided for adjusting the action of the magnet or solenoid, which may also be adjusted by varying the location of the magnet or the amount of current passed through the same, or both of these and the spring.

At the end of the day, or before the next, the boilers and mirrors are brought back to their initial position by hand or motive power.

All steam pipes, where flooded by light from the mirrors, are painted black, and have a transparent coating of varnish or are covered with celluloid or both, and where they are not under the effect of the mirrors, they are insulated.

What we claim as our invention and desire to secure by Letters Patent of the United States is:—

1. In apparatus for utilizing the heat of the sun, the combination of a longitudinally extending and transversely curved reflector, with a heat absorber so disposed in respect to said reflector as to receive the rays of the sun reflected thereby, said absorber presenting parallel longitudinal sides disposed at a short distance apart and expanded at their upper ends to form a longitudinally extending steam chest.

2. In apparatus for utilizing the heat of the sun, the combination of a longitudinally extending and transversely curved reflector, with a heat absorber so disposed in respect to said reflector as to receive the rays of the sun reflected thereby, said absorber presenting a narrow longitudinal column surmounted by an enlarged longitudinally extending bulbous head.

3. In apparatus for utilizing the heat of the sun, the combination of a longitudinally extending and transversely curved reflector with a heat absorber so disposed in respect to said reflector as to receive the rays of the sun reflected thereby, said absorber presenting a narrow longitudinal column extending parallel with the reflector and surmounted by an enlarged longitudinally extending bulbous head.

4. In apparatus for utilizing the heat of the sun, the combination of a curved reflector, and a heat absorber so disposed in respect to said reflector as to receive the rays of the sun reflected thereby, said heat absorber presenting in cross section a narrow column surmounted by an enlarged head and



being so disposed in respect to said reflector as to receive the reflected rays on both sides of said narrow column.

5 5. The combination, in apparatus for  
utilizing the heat of the sun, of a curved  
reflector, a heat absorber so disposed in re-  
spect to said reflector as to receive the rays  
of the sun reflected thereby, said reflector  
10 consisting of strips of mirror extending lon-  
gitudinally of the absorber and so disposed  
as to reflect the rays onto both sides thereof,  
and a partition extending downwardly from  
the bottom of the absorber to prevent the  
15 passage of air currents from one side of the  
absorber to the other underneath said ab-  
sorber.

6. The combination, in apparatus for  
utilizing the heat of the sun, of a curved re-  
flector with a heat absorber so disposed in  
20 respect to said reflector as to receive the  
rays of the sun reflected thereby, said ab-  
sorber having means for causing water  
therein to contact alternately with the bot-  
tom and top of the absorber during its  
25 longitudinal flow through the same.

7. The combination, in apparatus for  
utilizing the heat of the sun, of a curved  
reflector, a heat absorber so disposed in re-  
spect to said reflector as to receive the rays  
30 of the sun reflected thereby, and means for  
causing substantially uniform heating of  
the casing of the absorber both at bottom  
and top at any given point throughout the  
length of the same.

35 8. The combination, in apparatus for  
utilizing the heat of the sun, of a heat ab-  
sorber, means for supplying water thereto,  
a pipe for receiving steam generated in said  
absorber, means for reflecting the rays of  
40 the sun upon said absorber, and other means  
for reflecting the rays of the sun upon said  
steam-receiving pipe.

9. The combination, in apparatus for  
utilizing the heat of the sun, of a curved  
45 reflector, a heat absorber so disposed in re-  
spect thereto as to receive the rays of the  
sun reflected thereby, means for moving the  
reflector so as to cause it to follow the ap-  
parent movements of the sun, a thermal con-  
50 trolling device for said moving means, and a  
shading device so disposed in respect to said  
thermal controller that the latter will be  
alternately shaded from and exposed to the  
rays of the sun.

55 10. The combination, in apparatus for  
utilizing the heat of the sun, of a curved re-  
flector, a heat absorber so disposed in re-  
spect thereto as to receive the rays of the  
sun reflected thereby, means for moving said  
60 reflector to follow the apparent movements

of the sun, and a thermal controlling device  
for said moving means so disposed in re-  
spect to the absorber as to be alternately  
within and beyond the shadow of the same  
cast by the sun. 65

11. The combination, in apparatus for  
utilizing the heat of the sun, of a curved  
reflector, a heat absorber so disposed in re-  
spect thereto as to receive the rays of the  
sun reflected thereby, means for moving said  
70 reflector so that it will constantly maintain  
its most favorable position in respect to the  
sun, a thermal controller for said means,  
means for shading said controller from the  
rays of the sun, and means whereby the  
75 movement of the reflector is caused to carry  
said thermal device into or out of the shaded  
position.

12. The combination, in apparatus for  
utilizing the heat of the sun, of a curved  
80 reflector, a heat absorber so disposed in re-  
spect thereto as to receive the rays of the  
sun reflected thereby, means for turning the  
reflector to maintain it in its most favorable  
position in respect to the sun, an accelerator  
85 for quickening said movement, and a ther-  
mal device for actuating said accelerator.

13. In apparatus for utilizing the heat of  
the sun, the combination of a longitudinally  
extending and transversely curved reflector,  
90 a longitudinal heat absorber extending  
parallel with and suspended in the focal  
plane of said reflector, and a system of wire  
supports for said absorber which permit  
longitudinal expansion and contraction to  
95 take place without strain upon the absorber.

14. The combination, in apparatus for  
utilizing the heat of the sun, of a reflector,  
and a heat absorber so disposed in respect  
thereto as to receive the rays of the sun  
100 reflected thereby, said absorber being pro-  
vided with a coating which increases its  
heat absorbing properties, and a trans-  
parent covering applied directly to said  
coating. 105

15. In apparatus for utilizing the heat of  
the sun, the combination of a longitudinally  
extending and transversely curved reflector,  
a longitudinal heat absorber extending par-  
110 allel with and disposed in the focal plane of  
said reflector, a supporting framework for  
said reflector, and mechanical supports for  
the absorber which permit longitudinal ex-  
pansion and contraction without strain upon  
the absorber or framework. 115

In witness whereof we have signed this  
specification.

FRANK SHUMAN.  
CHARLES VERNON BOYS.